

**AN EVALUATION METHODOLOGY FOR
ASSESSING ARTIFICIAL LIGHTING QUALITY IN
ARCHITECTURE:
THE CASE OF APIKAM**

**A Thesis Submitted to
Graduate School of Engineering and Sciences of
İzmir Institute of Technology
in Partial Fullfilment of the Requirements for the Degree of**

DOCTOR OF PHILOSOPHY

in Architecture

**by
H. Gökhan KUTLU**

**January 2007
İZMİR**

We approve the thesis of **Hilmi Gökhan KUTLU**

Date of Signature

.....
Assoc. Prof. Dr. H. Murat GÜNAYDIN
Supervisor
Department of Architecture
İzmir Institute of Technology

11 January 2007

.....
Prof. Dr. Başak İPEKOĞLU
Department of Architectural Restoration
İzmir Institute of Technology

11 January 2007

.....
Asst. Prof. Dr. Özlem ERKARSLAN
Department of Architecture
İzmir Institute of Technology

11 January 2007

.....
Asst. Prof. Dr. Emre ERGÜL
Department of Architecture
İzmir Institute of Technology

11 January 2007

.....
Asst. Prof Dr. Abdullah SÖNMEZ
Department of Architecture
Dokuz Eylül University

11 January 2007

.....
Assoc. Prof. Dr. H. Murat GÜNAYDIN
Head of Department
İzmir Institute of Technology

11 January 2007

.....
Assoc. Prof. Dr. Barış ÖZERDEM
Head of the Graduate School

ACKNOWLEDGEMENTS

Over the past few years I have been privileged to work with and to learn from people, and to all those people I owe a debt I can never repay.

To Assoc. Prof. Dr. Murat Günaydin, I am grateful, firstly for providing me an environment in which I could set my own direction, and secondly for his many contributions to my understanding of research methodology and to this dissertation in particular. Asst. Prof. Dr. Özlem Erkarıslan, and Asst. Prof. Dr. Ömür Saygın have each contributed to my study through criticism and shaped this research in important ways. Asst. Prof. Dr. Gülnur Erciyes, helped in translation of some parts of the survey. Especially, I want to thank Assoc. Prof. Dr. Deniz Şengel for her valuable contributions in editing the text.

Family and friends, of course, provided the support network to sustain me throughout my studies. Mom, Dad, and Brother, thank you for everything, especially for the unfailing love that made the gloomiest times endurable. Thanks also to Mustafa Sevim, Zeynep Akıntı, Saliha Saat, Yüksel Pöğün, Kıvılcım Duruk, Erdal Uzunoğlu, Ali Sert, Nevin Ay, and Nursen Kaya for acts of friendship too numerous to name. I would also like to acknowledge Dr. Deniz Güner, for inspiring me to attempt graduate studies with his enthusiastic commitment to intellectual development as a way of life.

Special thanks to Maddie for keeping me satisfied with her energy and music that helped a lot during the process of writing.

I am grateful also to the administrative personnel of APIKAM, for their supportive role in the case study.

ABSTRACT

AN EVALUATION METHODOLOGY FOR ASSESSING ARTIFICIAL LIGHTING QUALITY IN ARCHITECTURE: THE CASE OF APIKAM

The aim of this dissertation is to design a qualitative evaluation methodology for artificial lighting. There is a problem in the general characteristics of lighting industry, deriving from its technical vocabulary which is mainly based on quantitative parameters, values, and systems which in some ways are neglecting the main ingredient of architecture: the user.

The evaluation methodology that is subject of this dissertation was considered as a qualitative approach to lighting quality. The study benefited from the knowledge of environmental psychology, concerning the effect of lighting on behaviors and tried to integrate it to the process of assessing lighting quality. The methodology depends on data collection by various means such as surveys, measurements, and computer simulations.

To test the qualitative evaluation methodology, a case study was designed in the exhibition hall of the Ahmet Piriştina City Archive and Museum (APIKAM) in İzmir. The evaluation methodology was successfully operated and made a detailed evaluation possible on the two lighting systems in the exhibition hall of APIKAM. Both lighting systems failed in functional aspects, because of the high intensity of light they produce, the emission of UV and IR wavelengths, and glare problems. They are simply not appropriate for the selected environment, where organic – based materials are exhibited. Recessed fluorescent lighting system failed in physiological aspects as it triggers less arousal than halogen spotlighting system. Both lighting systems have failed in attention scale under psychological aspects, because none of them supply continuity in the order of visual clues that match with the sequential order of the exhibition. For aesthetic and environmental judgments, the results of the survey showed that halogen lighting system was the preferred one by the subjects. For the sub-part of feelings, recessed fluorescent lighting systems failed, because it influenced generally negative feelings, while positive feelings are generally influenced by halogen spotlighting system.

ÖZET

MİMARLIKTA YAPAY AYDINLATMA NİTELİĞİNİ BELİRLEMEK İÇİN BİR DEĞERLENDİRME YÖNTEMİ: APIKAM ÖRNEĞİ

Bu tezin amacı yapay aydınlatma kalitesini belirlemeye yönelik niteliksel bir değerlendirme metodolojisi geliştirmektir. Aydınlatma endüstrisinin temel problemi niceliksel parametreler ve sistemler üzerinde yükselen teknik yapısıyla mimarlığın temel bileşenlerinden biri olan insan faktörünü gözardı eden bir kurguya sahip olmasıdır.

Değerlendirme metodolojisi, aydınlatma aracılığı ile oluşan mekansal dinamikler üzerinde etkisi olduğu düşünülen tüm değişkenleri gözeten niteliksel bir yaklaşım olarak gözetilmiştir. Aydınlatmanın davranış üzerindeki etkilerini de gözeten bu çalışma bilgi alanı olarak çevre psikolojisinden yararlanmış ve bu davranışsal etkileri aydınlatma kalitesinin belirlenme sürecine dahil etmeyi amaçlamıştır. Veri toplamak amacıyla anketlerden, manuel ölçümlerden ve bilgisayar simülasyonlarından yararlanılmıştır.

Değerlendirme metodolojisini test etmek amacıyla, İzmir Ahmet Piriştina Kent Arşivi ve Müzesi (APIKAM) sergi salonunda bir çalışma alanı oluşturulmuştur. Geliştirilen metodoloji, APIKAM sergi salonunda mevcut iki aydınlatma sistemine ilişkin olarak detaylı bir değerlendirmeyi mümkün kılmıştır. Her iki aydınlatma sistemi de, ürettikleri ışığın yüksek yoğunlukta olması, UV ve IR dalgaboylarını ışımaları, ve de yarattıkları kamaşma problemleri nedeniyle fonksiyonel değerlendirmeler özelinde başarısız olmuştur. Her iki sistem de organik kökenli malzemelerin sergilendiği bir ortamın aydınlatılması için uygun değildir. Fizyolojik değerlendirmede, floresan sistem, halojen sisteme oranla daha az uyarıcı etkiye sahip olduğu için başarısız olmuştur. Psikolojik değerlendirmede, her iki aydınlatma sistemi de dikkat ölçeği özelinde, mekan hiyerarşisi ile çakışan bir görsel izlek oluşturamadıkları için başarısız olmuşlardır. Anket sonuçları, estetik ve mekansal yargılar ölçeğinde, tercih edilen aydınlatmanın halojen sistem olduğunu göstermektedir. Duygusal tepkiler özelinde, floresan aydınlatma sistemi, genel olarak olumsuz duygulanımları tetiklediği için başarısız olmuştur.

To my family

TABLE OF CONTENTS

LIST OF FIGURES	ix
LIST OF TABLES	xii
CHAPTER 1. INTRODUCTION	1
1.1. Definition of the Problem	1
1.2. Background	4
1.3. Objectives	6
1.4. Methodology	6
1.4.1. Case Study	9
1.4.2. Survey	11
1.4.3. Photometric Calculations.....	13
CHAPTER 2. A REVIEW OF QUALITY CONCEPTS IN LIGHTING	16
2.1. The Development of Artificial Lighting in the Twentieth Century. Lighting Engineering and Its Quality Definitions	17
2.1.1. Models in Lighting Engineering Used to Define Quality.....	21
2.1.1.1. Visibility Level Model	22
2.1.1.2. Equivalent Sphere Illuminance	23
2.1.1.3. Visual Comfort Probability	25
2.1.1.4. Comfort, Satisfaction, and Performance Index	26
2.1.1.5. Relative Visual Performance	27
2.2. A Qualitative Way in Defining Quality in Lighting from the Architectural Point of View	28
CHAPTER 3. THE STRUCTURE OF THE EVALUATION METHODOLOGY FOR ARTIFICIAL LIGHTING QUALITY	33
3.1. Functional Aspects.....	34
3.1.1. Visibility, Safety and Task Performance.....	35
3.2. Physiological Aspects	44
3.2.1. Health, Arousal and Stress	44

3.3. Psychological Aspects	49
3.3.1. Attention	50
3.3.2. Aesthetic and Environmental Judgments	51
3.3.3. Feelings and Preferences	53
CHAPTER 4. CASE STUDY	59
4.1. The Requirements of Museums and Art Galleries in Terms of Lighting	59
4.1.1. Quantitative Requirements	60
4.1.2. Qualitative Requirements	73
4.2. Evaluation of the Data	78
4.2.1. Functional Aspects	78
4.2.2. Physiological Aspects.....	88
4.2.3. Psychological Aspects	91
4.2.3.1. Attention	91
4.2.3.2. Aesthetic and Environmental Judgments	94
4.1.3.3. Feelings and Preferences	101
4.1.4. Imperfections	114
CHAPTER 5. CONCLUSIONS	117
5.1. Concluding Remarks and Recommendations for Further Research ...	123
REFERENCES	125
APPENDICES	
APPENDIX A. PHOTOMETRIC RESULTS FOR RECESSED FLUORESCENT LIGHTING SYSTEM	135
APPENDIX B. PHOTOMETRIC RESULTS FOR HALOGEN SPOTLIGHTING SYSTEM.....	199
APPENDIX C. SURVEY	263

LIST OF FIGURES

<u>Figure</u>	<u>Page</u>
Figure 1.1. Conceptual Framework in Detail.....	8
Figure 1.2. Determinants of Spatial Quality	9
Figure 1.3. Plan of the Exhibition Hall in APIKAM	10
Figure 1.4. User interface of Dialux 4.2.0.5 (plan view)	14
Figure 1.5. User interface of Dialux 4.2.0.5 (3D view)	14
Figure 2.1. Measurement of ESI - Step 1	24
Figure 2.2. Measurement of ESI - Step 2	24
Figure 2.3. Derivation of CSP Index	26
Figure 2.4. Graphic representation of the RVP Model	27
Figure 2.5. Pantheon, Rome	31
Figure 2.6. Unlike the walls, the object in the middle of space receives uniform illumination which makes it appear dull and uninteresting.	32
Figure 2.7. With the help of two spotlights the same object became a focal point in the space.	32
Figure 3.1. Three Aspects of Lighting Quality	34
Figure 3.2. Determinants of Functional Aspects.....	35
Figure 3.3. Relationship between equivalent veiling luminance and angular separation between line of sight and glare source.	38
Figure 3.4. Relationship between maximum luminance of glare source and angular separation between line of sight and glare source	39
Figure 3.5. Age and sensitivity to brightness	39
Figure 3.6. Spectral power distribution graph for daylight.....	41
Figure 3.7. Spectral power distribution for a fluorescent lamp.....	42
Figure 3.8. Color Temperature of Light Sources.	43
Figure 3.9. Determinants of Physiological Aspects	44
Figure 3.10. Typical daily rhythms of body temperature, melatonin, cortisol, and alertness in humans for a natural 24-hour light/dark cycle.	46
Figure 3.11. Alertness levels according to time passed after midnight.....	47
Figure 3.12. Spectral biological action curve (based on melatonin suppression), in blue, and the visual eye sensitivity curve, in red.	48

Figure 3.13. Determinants of Psychological Aspects	49
Figure 3.14. Diagram of the Evaluation Methodology for Artificial Lighting Quality	58
Figure 4.1. Detail of a gas pipe, showing the burners on both sides.....	61
Figure 4.2. The pigments on the edge of this watercolor have not faded because they have been protected by the mount.....	62
Figure 4.3. Wall lighting using linear luminaries.....	67
Figure 4.4. Individual Lighting	67
Figure 4.5. The optimum angle of incidence.	68
Figure 4.6. Lighting solutions for vertical visual tasks free of reflected glare	68
Figure 4.7. Internal illumination for showcases.....	69
Figure 4.8. External illumination of showcases.	69
Figure 4.9. Identifying the “forbidden zones” for horizontal reflecting surfaces	70
Figure 4.10. Showcase lighting using a fibre optic system.....	72
Figure 4.11. The lighting should render the form and the texture of the sculpture.....	72
Figure 4.12. Floor-standing luminaries.....	73
Figure 4.13. Hagia Sophia, Istanbul. The halogen uplights are mounted onto a rail with as minimum connection detail on walls as possible.....	73
Figure 4.14. Perception of three-dimensional forms.....	75
Figure 4.15. The diffuse lighting system in Istanbul Modern.....	76
Figure 4.16. Diagram of the Evaluation Methodology for Artificial Lighting Quality of APIKAM	79
Figure 4.17. Placement of calculation surfaces both lighting systems in the exhibition	80
Figure 4.18. Photometric results for CS1 (lx) (Recessed Fluorescent).....	81
Figure 4.19. Photometric results for CS2 (lx) (Recessed Fluorescent).....	82
Figure 4.20. Photometric results for CS3 (lx) (Recessed Fluorescent).....	82
Figure 4.21. Photometric results for CS4 (lx) (Recessed Fluorescent).....	83
Figure 4.22. Photometric results for CS1 (lx) (Halogen Spotlighting)	84
Figure 4.23. Photometric results for CS2 (lx) (Halogen Spotlighting)	84
Figure 4.24. Photometric results for CS3 (lx) (Halogen Spotlighting)	85
Figure 4.25. Photometric results for CS4 (lx) (Halogen Spotlighting)	85
Figure 4.26. Reflected glare from floor under recessed fluorescent lighting.....	86

Figure 4.27. Reflected glare from floor under halogen spotlighting.....	86
Figure 4.28. Reflected glare on vertical panels under recessed fluorescent lighting	87
Figure 4.29. Reflected glare on vertical panels under halogen spotlighting. Both the light sources and the standing person are reflected on the surface.....	87
Figure 4.30. Visiting order for the exhibition hall in APIKAM	91
Figure 4.31. Horizontal illumination levels for recessed fluorescent in isolines	92
Figure 4.32. Horizontal illumination levels for recessed fluorescent in value chart..	92
Figure 4.33. Horizontal illumination levels for halogen spotlighting in isolines.....	93
Figure 4.34. Horizontal illumination levels for halogen spotlighting in value chart	93
Figure 4.35. Perceptual preferences and attention study in survey	94
Figure 4.36. General problems under recessed fluorescent system	116
Figure 4.37. General problems under halogen spotlighting system	116

LIST OF TABLES

<u>Table</u>	<u>Page</u>
Table 1.1. General characteristics of subjects participated in survey	12
Table 2.1. Recommended Lighting Levels	20
Table 2. 2. Differences Between Quantitative and Qualitative Research.....	29
Table 4.1. Maximum Illuminance Recommended (lx)	64
Table 4.2. Recommended Illuminance and Illuminance-Hours per Year	65
Table 4.3. JIS Illuminance Standards	66
Table 4.4. CIE Illuminance Standards	66
Table 4.5. Calculation surface list for recessed fluorescent lighting system	80
Table 4.6. Calculation surface list for recessed halogen spotlighting system	83
Table 4.7. Mean and SD for aroused-unaroused.....	88
Table 4.8. T-Test for aroused-unaroused	89
Table 4.9. Variance for Age (aroused-unaroused).....	89
Table 4.10. Mean and SD for sleepy-wideawake	90
Table 4.11. T-test for sleepy-wideawake	90
Table 4.12. Mean and SD for perception of form (strong-weak)	94
Table 4.13. T-test for perception of form (strong-weak)	95
Table 4.14. Mean and SD for perception of structural elements (strong-weak).....	95
Table 4.15. T-test for perception of structural elements (strong-weak)	96
Table 4.16. Mean and SD for the Perception of details	96
Table 4.17. T-test for perception of details	97
Table 4.18. Mean and SD for cozy-cold	97
Table 4.19. T-test for cozy-cold.....	98
Table 4.20. Mean and SD for interesting-dull	98
Table 4.21. T-test for interesting-dull	99
Table 4.22. Mean and SD for inviting-repulsive	99
Table 4.23. T-test for inviting-repulsive	100
Table 4.24. Mean and SD for “I like the gallery”	100
Table 4.25. T-test for “I like the gallery”.....	101
Table 4.26. Mean and SD for happy-unhappy	101
Table 4.27. T-test for happy-unhappy.....	102

Table 4.28. Mean and SD for annoyed-pleased	102
Table 4.29. T-test for annoyed-pleased.....	103
Table 4.30. Mean and SD for relaxed-tense	103
Table 4.31. T-test for relaxed-tense	104
Table 4.32. Variance related to age (relaxed-tense)	104
Table 4.33. Mean and SD for autonomous-guided.....	105
Table 4.34. T-test for autonomous-guided.....	105
Table 4.35. Mean and SD for hopeful-despairing.....	106
Table 4.36. T-test for hopeful-despairing	106
Table 4.37. Mean and SD for dominant-submissive.....	107
Table 4.38. T-test for dominant-submissive	107
Table 4.39. Variance related to sex (dominant-submissive).....	108
Table 4.40. Variance related to age (dominant-submissive)	108
Table 4.41. Mean and SD for talkative-shy	109
Table 4.42. T-test for talkative-shy.....	109
Table 4.43. Mean and SD for excited-calm	110
Table 4.44. T-test for excited-calm.....	110
Table 4.45. Mean and SD for controlling-controlled.....	110
Table 4.46. T-test for controlling-controlled	111
Table 4.47. Mean and SD for satisfied-unsatisfied.....	111
Table 4.48. T-test for satisfied-unsatisfied	112
Table 4.49. Variance related to age (satisfied-unsatisfied).....	112
Table 4.50. Mean and SD for stable-depressed	113
Table 4.51. T-test for stable-depressed	113
Table 4.52. Mean and SD for important-unimportant	114
Table 4.53. T-test for important-unimportant.....	114

CHAPTER 1

INTRODUCTION

Artificial lighting has been one of the important basics of architecture, since it provides possibility to all kinds of activities especially at night, when the natural source of illumination –the sun- is not available. The invention of electricity at the end of the nineteenth century initiated a new era for architecture, where electric lighting became a crucial component for spatial quality. As Mies van der Rohe stated, the history of architecture is the history of man’s struggle for light (Trauthwein 2003). Light plays a central role in the design of a visual environment. The architecture, users, and objects are all made visible by the lighting. However, light is no longer just an essential element that is needed when it is dark. Moreover it is an effective instrument influencing our perception of architecture, consequently our appreciation of spatial quality.

Architecture is a multi-layered profession interrelated with varying disciplines such as art, engineering, psychology, sociology, philosophy, etc. Each of these varying disciplines has its own unique terminology, regulations, and ways of manipulating problems. When “quality” is at stake; all these varying disciplines would define and judge from different perspectives. Thus “spatial quality” should be assumed as a summary of all these perspectives.

1.1. Definition of the Problem

During the twentieth century electric lighting became the subject of a profession with its own enormous terminology and conventions. The most important innovation was the appearance of lighting engineering in the light of the idea that artificial lighting was a technical theme. This evolution was the natural result of a belief that lighting comprised a science and solving lighting problems needed a technical and scientific formation. There is nothing unusual or wrong about this belief. Actually it may be seen as a necessity for this profession to be able to improve in the world of technology and rationality, where specialization is fundamental. Thus the new profession soon established its own sphere of terminology which was mostly defined by engineers and technical specialists. Architects and lighting engineers established a collaboration from

the start and together determined the night-time look of cities. This co-operation, however, did not last long, since lighting engineering soon became the one and only profession with its large supporting technical background and technical vocabulary that enabled deciding the night-time look of cities (Jones 1983).

The problem here lies in the general characteristics of this technical vocabulary which is mainly based on quantitative parameters, values, and systems which in some ways neglect the main ingredient of architecture: the user.

The other problem is the light engineers' understanding and treatment of quality which perhaps unconsciously separates "lighting quality" and "spatial quality" from each other. This judgment could be seen as too harsh, but then, what could be the explanation for the absence of the major peculiarities of "spatial quality" in the definition of good lighting criteria? The British Lighting Council (1962) defines good lighting as follows:

...What then, is good lighting? It is not just good lamps, or good fittings, or plenty of light, or lack of glare, or suitable color or a workmanlike installation, or lighting well maintained. It isn't either daylighting or electric lighting. It is all these things put together in such a way that people can get on with it safely, quickly, certainly, and easily; and all at a reasonable cost in relation to other essential costs.

It is remarkable that all mentioned criteria are related to visual ability, safety, and economics. It is important to recognize that the focus of lighting researchers has been the optimization of visual performance. Their investigations concern the characteristics of lighting and tasks that make details easy to see and that would enable safety in spaces. Non-visual aspects of the lighting-space relationship, such as motivation, subjective impressions of the illumination, behavioral outcomes, and physiological effects have been clearly of secondary interest.

According to lighting engineering good lighting is related to the supplied visual abilities, illuminance levels, and uniform distribution of light. Throughout the twentieth century several models had been developed to measure and predict lighting quality, such as Visibility Level Model (VL), Equivalent Sphere Illuminance (ESI), Visual Comfort Probability (VCP), and Relative Visual Performance (RVP). Most of these models are still in use today and mostly deal with the issue of visual abilities and disabilities in space. There are some other models which are concerned with economics and energy consumption.

Supplying visual ability and achieving required illuminance levels do not necessarily ensure good lighting quality. The quality as well as the quantity of illuminance is important in producing a comfortable, productive, aesthetically pleasing lighted environment and achieving “quality” in lighting needs to take users into consideration with all the requirements without limiting it to visual ability alone. Today, our most comfortable, pleasant spaces are those in which designers and users have retained control over the lighting: spaces such as museums, cinemas, and restaurants, in which objects of interest are correctly emphasized by the luminous environment. The lighting in private homes is generally satisfactory and pleasant for the same reason, because it has usually been designed and adjusted by the users to suit their specific needs for visual information, not to achieve some mandatory prescribed amount of light.

Various researches have demonstrated that light has a profound impact on people, which should be studied under varying criteria such as spatial aesthetics, psychology, physiology, etc. While fulfilling the visual needs, lighting engineering does not pay much attention to physiological and psychological comfort and spatial aesthetics.

Light is a visual phenomenon which can affect motivation and performance levels. Light also affects our biological clocks in the following manner: It is well known that circadian rhythms, such as sleeping or waking cycles, are influenced by light. Many business travelers use melatonin tablets to help them maintain their work efficiency and performance when they travel to locations in different time zones. What many people do not realize is that simply increasing their exposure to light could also help them naturally alter their melatonin levels (Steelcase 1999).

Lighting on the other hand has a strong psychological effect on people. It has many emotional qualities that can considerably change people's moods. Light influences our well-being, the aesthetic effect and the mood of a room or area. Phototropism is another psychological effect of light. Since lighting is always a part of our physical environment, it is not much to say that we are constantly manipulated by lighting.

Lighting quality should be redefined as the degree to which a lighting installation fulfils all the requirements of user needs, which have been summed up under three main headings as physiological, functional, and psychological in this dissertation. Moreover, good lighting should also consider spatial aesthetics, economics, and energy consumption. Technical know-how is sine-qua-non for lighting. However, concepts of lighting quality could be enhanced in order to serve spatial quality

determined as in architecture. It is certain that lighting is a science and will remain so. However, being so much related to architecture and being so much active in the creation of spaces, it is believed that the lighting industry should be open to some further concepts from other disciplines such as architecture, art, and psychology.

1.2. Background

I believe in an emotional architecture. It is very important for humankind that architecture should move by its beauty: if there are many equally valid technical solutions to a problem, the one which offers the user a message of beauty and emotion, that one is architecture.

Luis Barragan (Ambasz 1976)

Lighting can be used to modify spaces in many different ways. It can reveal or conceal surfaces, heighten or diminish spaces. The theatrical lighting designer and the artist have often exploited lighting in this way, and there is much that the architect and lighting engineer can learn from them (Hopkinson 1969).

According to Millet (1996) our experience of light is connected to specific places where light contributes to the identification of *genius loci*, the peculiar character of a place as it is impressed upon our minds. She also adds that ideally, light not only fulfills its function of providing illumination for visual activities but does so in a way that enriches our experience.

It is useful to discuss the lighting problem from another aspect, which is beyond the purely “lighting function” which will depend upon the physiological needs of those using the space. It is the architectural function relating lighting needs to all other design considerations that must form part of the architectural compromise (Philips 1989).

Lam (1992) discusses the quality problem in lighting as follows: “A comfortable, pleasing, relevant environment is as important as visual performance determined by the conditions of good lighting”. Quality, rather than quantity, is the key to good lighting. A small improvement in the quality of the luminous environment produces better visual performance than a large increase in intensity. Lam (1992) adds that lacking an understanding of the basic principles involved, the technicians who now control our luminous environments have reduced the criteria for illumination to simple numbers, which are basically unrelated to vision, perception, comfort, or pleasure.

Lechner (1990) demonstrates that lighting is considered only as a problem in quantity and not as a problem of quality which must be integrated with architecture. Ignoring quality has always been at the expense of visual performance. The change in the atmosphere of a space denotes a qualitative change in which quantity of light is of only secondary importance (Von Meiss 1990).

The appropriate quantity of light contributes to the achievement of good quality, but is not its sole determinant. Other dimensions, including illuminance uniformity, luminance distributions, spectral power distribution, and glare are potential contributors to overall lighting quality (Miller 1994). What is “appropriate” depends on the setting, activities, aesthetics, and other user needs in the space. Furthermore, the characteristics of the people who will use or experience the space also influence whether or not the lighting installation will achieve good quality (Boyce 1981).

Flynn et al. (1992) noted that lighting, in addition to providing task visibility, also influences motivation, orientation, mood, social interaction and well-being.

A large number of research projects that compare the effects on health, well-being and alertness as a result of people working under different lighting conditions have been carried out. The results show that good lighting indeed has important beneficial effects, not only visually but also biologically. Bommel and Beld (2003) stated that, on the basis of research on the biological effects of lighting, it is evident that the rules governing the design of good and healthy lighting installations are, to a certain degree, different from the conventionally held rules. Not only the light cast on the visual task, but also light that enters the eye determines the overall quality of lighting.

The standard design process, fostered by the Illuminating Engineering Society (IES), is obviously unsuited to produce a high-quality fit between needs and luminous environment, nor was it ever intended to produce such a fit (Lam 1992). A lighting concept should be derived from the set of programmed activities and biological needs, so that the definition of the luminous environment will complement and reinforce the general architectural concepts; then - only then - should details and hardware be selected to execute the concept (Lam 1992). Lam continues to argue that this is the diametric opposite of the typical “engineered” approach, which starts with the selection of light fixtures and then, taking them as givens, places them in patterns to achieve predetermined illumination levels. Veitch and Newsham (1996) have argued about lighting quality as follows:

The failure to reach agreement about lighting quality has been seriously impeded by the failure to recognize the question as one part of the larger attempt to determine the nature of environmental quality, provided to support human activity. The outcomes that benefit from good lighting quality are behavioral outcomes. Behavioral scientists have been remiss in not looking to the lighting literature for a different perspective. Lighting researchers have been remiss in not following the behavioral literature, and in particular its standards for research design, methods, statistical analysis, and reporting. In consequence, we know less about lighting quality than we should after more than a century of lighting practice and ninety years of its professional organizations.

1.3. Objectives

In this dissertation light is examined as a creative design tool not only with its ability to supply visual communication in space, but also in terms of its contributions to space and spatial dynamics in various degrees and its effects on users on both physiological and psychological scales. The aim of this dissertation is to design a qualitative evaluation methodology for artificial lighting, which will help criticize and judge the quality of a pre-installed artificial lighting system by forming criteria related to visual and non-visual effects of light. The secondary intention is to carry out the main concepts and the in-between parts of lighting and space relationship and to fill the gaps in illumination techniques under the guidance of spatial quality concepts.

1.4. Methodology

The evaluation methodology that is subject of this dissertation is considered as a qualitative approach to lighting quality as it tries to deal with all the variables which are thought to be effective in spatial dynamics created through lighting. Beyond lights' main (and mostly known) ability of setting up the required conditions in terms of seeing; its effects on the appearance and perception of the architectural body and architectural components; and its effects on users both in physiological and psychological scales have been taken into account. Lighting study so far has produced a large body of knowledge concerning the visual effects of light and created several models as well as regulations for controlling light for that purpose, with little attention to other consequences such as the architectural space itself, and behavioral outcomes. This study may be seen as a way of integrating the non-visual effects of light in the process of ascertaining lighting quality, without neglecting the visual parameters instead of feeding from them. In this framework, this study will attribute to the analysis of

artificial lighting quality without reaching one unique numerical data, instead, an evaluation where numerical and non-numerical variables have been together interpreted. With an intention to cover all possible features in the lighting-space-user relationship, the evaluation methodology is structured as a combination of various aspects, as physiological, functional, and psychological respectively. Each of them works like a plug that includes several variables inspected under various lighting conditions such as illuminance (amount of light), luminance distribution, glare, lighting systems, and color. The evaluation methodology is subject to change in accordance with the architectural function, as each function has its own unique requirements in terms of lighting. As the structure of the evaluation methodology is formed of separate plugs, it is possible to add different aspects or remove some of them according to the intended function of space. This distinctive feature renders the constructed methodology valid for varying architectural functions upon little modification. Unlike the quantitative models developed by light engineers, in this qualitative approach, each part results in separate outcomes. These outcomes under three variables together form an answer for the quality of lighting in a space with detailed recommendations. Thus, without trying to reach a single magical number, all numerical and non-numerical factors were together evaluated to assess the quality of lighting.

Prior research about lighting from varying disciplines such as architecture, engineering, and environmental psychology were examined in order to reach the criteria in terms of architectural aesthetics, physiological, and psychological needs.

The main structure of the evaluation methodology is inspired from a study, done by Durmisevic and Sarıyıldız in 2001 in Delft University of Technology, which is a model for quality assessment of underground spaces-public transport stations. The main idea of that study was to deal with all the variables which were thought to be effective in terms of quality. Durmisevic and Sarıyıldız (2001) designed a conceptual framework (Figure 1.1); based on the idea that architecture integrates both function and form. According to them, through function and form, the psychological aspects are interwoven by having an influence on the experience of space in a given context. Only when both are together they give to each other a meaning and a quality. Under three main aspects as functional (Qf), psychological (Qp), and structural (Qs); 23 variables were examined in detail for quality assessment. The level of quality was determined as the sum of these three aspects ($\sum Q$) (Figure 1.2). Thus, it is important that the design has an appropriate response for each variable.

Functional aspects comprise the functional requirements for an underground station, internal connections of the spaces and efficiency of movement. Psychological aspects are all aspects that are related to the user's experience of a space beginning with public safety on one side and comfort on the other. Structural aspects include the overall quality of the construction including its flexibility and possibility to change. In other words, the main technical requirement of a structure is sustainability.

This work of Durmisevic and Sariyıldız has influenced this dissertations' methodology in a particular way, which is the idea of dealing with every variable that is thought to be effective in spatial quality. A conceptual framework was formed, which is peculiar to lighting-user-space relationship. Then each variable under the conceptual framework were inspected under various lighting conditions. This topic will be explained in detail in Chapter 3.

CONTEXT

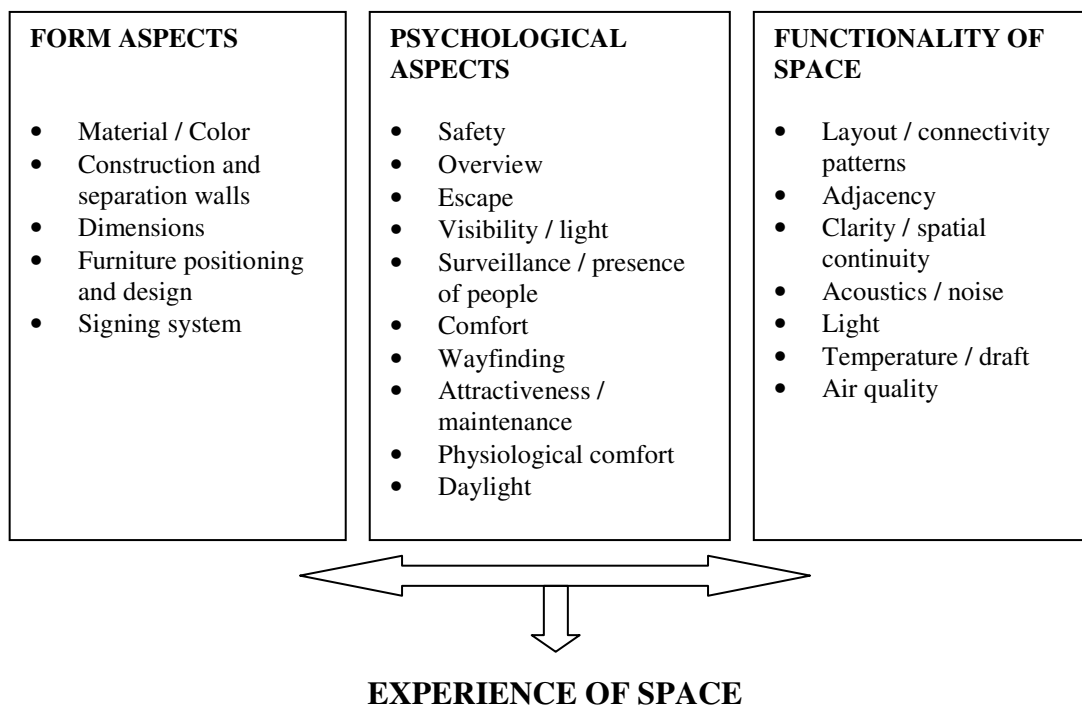

Figure 1.1. Conceptual Framework in Detail
(Source: Durmisevic and Sariyıldız 2001)

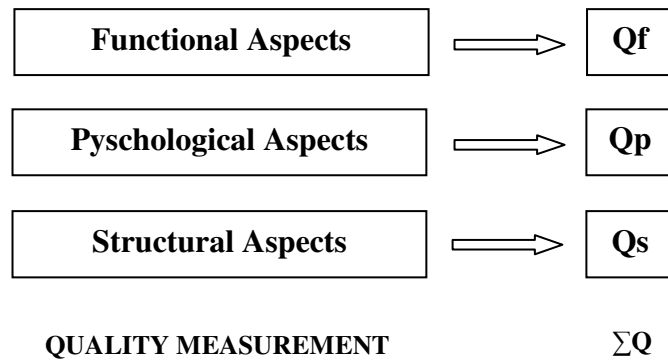

Figure 1.2. Determinants of Spatial Quality
(Source: Durmisevic and Sarıyıldız 2001)

1.4.1. Case Study

To test the qualitative evaluation methodology, a case study was designed in the exhibition hall of the Ahmet Piriştina City Archive and Museum (APIKAM) in İzmir, which was a fire station before the renovation done by the Municipality of İzmir between the years 2002 and 2004. The building is now used for cultural and educational purposes as the City Archive and Museum.

The main reason for choosing this space was that it is illuminated only by means of artificial light, which is made possible by two different lighting systems. The first one is a ceiling recessed fluorescent box system with a transparent methacrylate flat diffuser. Each box includes four fluorescent tubes with 5400 lm light output. 40 boxes with 216000 lm in total are used to illuminate the space. The second lighting system is a halogen spotlighting system which is mounted on tracks on the ceiling with four different suspension heights as 40, 60, 80, and 160 centimeters respectively. Each spot has 1279 lm light output at a 10.0° light angle. 217 spots with 277543 lm in total are used to illuminate the space. The two different lighting systems are not operated at the same time. There is not a distinct order known for the selection between them. Although the question was put, no satisfactory answer was obtained. It looks like it is a random choice mostly related to economical parameters, because the more preferred lighting system is the recessed fluorescent box system which is five times cheaper to operate. The lighting systems are assembled by an individual who owns a lighting store in Manisa. He mentioned that, his main aim when designing the lighting systems was to have a direct light on each task surface and create a dramatic effect in the exhibition. He added that the fluorescent lighting system was not his choice. He claimed that the

fluorescent lighting system was demanded by the employer for supplying basic task lighting (visual access, safety) at times when no visitors are present in the exhibition.

The exhibition is mostly visited by students from high schools and universities, so the average user age range is between 15 and 30. Visits are made generally in groups under the supervision of an official guide, with a lecture about the history of İzmir. The exhibition includes three parts consisting of the headings; History of İzmir (3000 B.C. - 1933 A.C), City and Trade (1838-1933), and City and Fires. There is no real statistics available for the amount of visitors for this exhibition. The official guide claimed that the amount of visitors is up to the seasons. He added that in fall, winter, and spring, when the schools are open, they welcome group visitors at least two days in a week in general. He mentioned an approximate number of 150 visitors per week for high season. In summer the exhibition welcomes a small amount of individual visits.

The exhibition hall is rectangular in shape and formed by three rectangles attached to each other side by side without any auxiliary spaces in the places of transition (Figure 1.3). It has an area of 436.93 square meters.

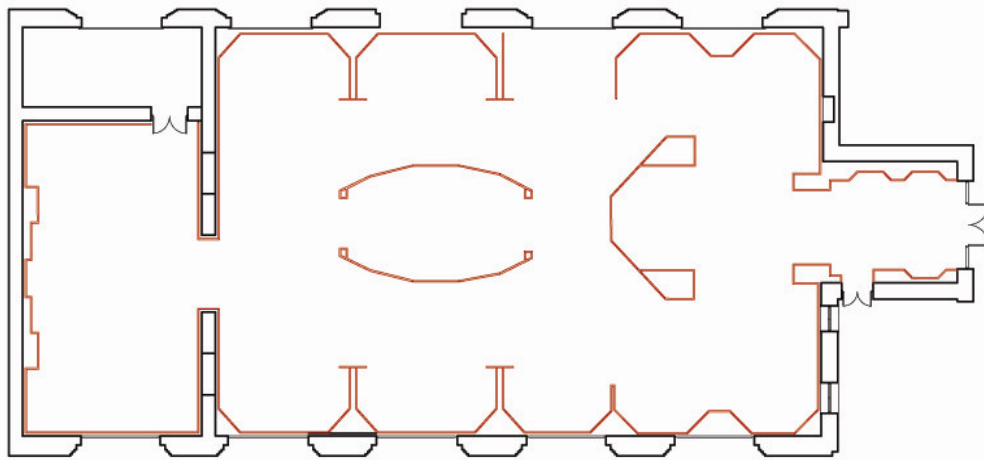

Figure 1.3. Plan of the Exhibition Hall in APIKAM

The walls in the exhibition are smoothly plastered and colored with a water-based very light matte yellow paint which has a reflectance factor of 0,70. The suspended ceiling is matte white and has a reflectance factor of 0,78. The shiny granite floor receive direct light from both of the lighting systems and has a reflectance factor of 0,68. The task surfaces are of laminated wood in matte white and have a reflectance factor of 0,65.

1.4.2. Survey

A survey was carried out to assess user evaluations related to the two lighting systems of the exhibition hall in APIKAM. The survey included five sections which deal with different dimensions of the lighting-user-space relationship, as personal information, lighting and task, aesthetic and environmental judgments, feelings, and perceptual preferences.

The first section includes four questions related to sex, age, job, and visual disabilities. The second section includes four questions too which ask subjects to critic their visual abilities within the space according to lighting systems. The third section includes eleven questions to help subjects judge the lighting systems within aesthetical and environmental scales.

The fourth section is a P.A.D. scale seeking for emotional outcomes related to lighting with fourteen pairs of adjectives. P.A.D. is a three dimensional temperament model developed by Mehrabian (1976). The latter theorized that one can describe any emotion with these three dimensions: pleasure-displeasure (P), arousal-nonarousal (A), and dominance-submissiveness (D). “P” signifies that one experiences more pleasure than displeasure. It relates positively to extraversion, affiliation, nurturance, empathy, and achievement, and negatively to neuroticism, hostility, and depression. “A” signifies that one responds strongly to unusual, complex, or changing situations. It relates to emotionality, neuroticism, sensitivity, introversion, schizophrenia, heart disease, eating disorders, etc. “D” signifies that one feels in control over his/her life. It relates positively to extraversion, assertiveness, competitiveness, affiliation, social skills, and nurturance, and negatively to neuroticism, tension, anxiety, introversion, conformity, and depression.

The fifth section includes two questions for assessing perceptual preferences and attention levels according to the lighting systems.

Each subject filled the survey twice, once for the ceiling recessed fluorescent lighting system and once for the halogen spotlighting system. Before filling the surveys they were explained clearly what to do and were asked freely to visit the exhibition for five minutes under each lighting system. Most of the questions included a likert scale from 1 to 5. Subjects checked a number which was closer to their opinion. 67 subjects participated in a time span of three days. The amount of subjects covers the two thirds

of the amount of visitors for three days. The general profile of the subjects in terms of age, sex, job, and visual disabilities is given in Table 1.1.

The data collected through surveys is evaluated with the software named “Analyze It for Excel” which includes Anova, Manova, Chi Square, and other tools to obtain the correlations among different variables. The collected data is exposed to four different tests with the help of this software. The first test is a categorical summary which finds the mean and standard deviation of the selections. The second test is the t-test with a hypothesis that Ceiling Mounted Fluorescent Lighting System \neq Halogen Spotlighting System. It checks whether there is a distinct variance between the two lighting systems related to the selected parameter or not. The third and fourth tests seek the variance related to sexual preferences and age differences respectively.

Table 1.1. General characteristics of subjects participated in survey

Sex	Female	38
	Male	29
Age	20-30	39
	30-35	17
	35-40	8
	40-50	3
Job	Student	39
	Public Officer	8
	Officer	13
	Freelance	7
Visual Disabilities [corrected]	Longsighted	14
	Shortsighted	4
	Astigmatic	5

1.4.3. Photometric Calculations

All photometric calculations which cover the structural and spatial components and furnishing are made through the lighting software Dialux (Version 4.2.0.5) in very accurate mode. Dialux is an open-source program for calculation and visualization of indoor and outdoor lighting systems. The main advantage of the program is its accuracy in calculation and its ability to work with almost all widely known lighting manufacturers through software plugs, which means that it is possible to make calculations concerning almost any lighting systems of any brand. The user interface of the software is shown in Figure 1.4 and Figure 1.5.

The calculations of Dialux are compared with the results obtained through an exposure meter manually (Gossen Variosix F2). An exposure meter is a device used generally by photographers to measure light intensity. However the measurements of this device are shown as film exposure and F-stop setting rather than in luxes. The exposure indicator of an exposure meter is in seconds, to be more precise in fractions of a second. That means when an exposure meter shows 125, it actually indicates 1/125 of a second. F-stop value indicates the amount of light allowed through the lens by the iris opening. A third indicator is the Ev value, which is obtained by summing up the reference numbers of the exposure and the F-stop (RNt and RNf). As lighting calculations require measurements in lux, the EV values obtained by exposure meter need to be converted to lux through the following formula:

$$I_{\text{lux}}=2.5 \times 2^{(\text{RNt}+\text{RNf})}=2.5 \times 2^{\text{EV}}$$

The measurements are made on the floor and on task surfaces for both lighting systems. Eleven points on floor and four points on four different task surfaces at a height of eighty centimeters are used for manual measurements. The amount of the calculation surfaces derives from the variety of the horizontal illuminance levels supplied by the lighting systems, which means all photometric results for bright, semi-bright, and dark surfaces are included in the comparison process. After the comparison a difference of only 2 lm was detected on floor measurements. As this is a negligible amount of deviation, no calibration was made manually.

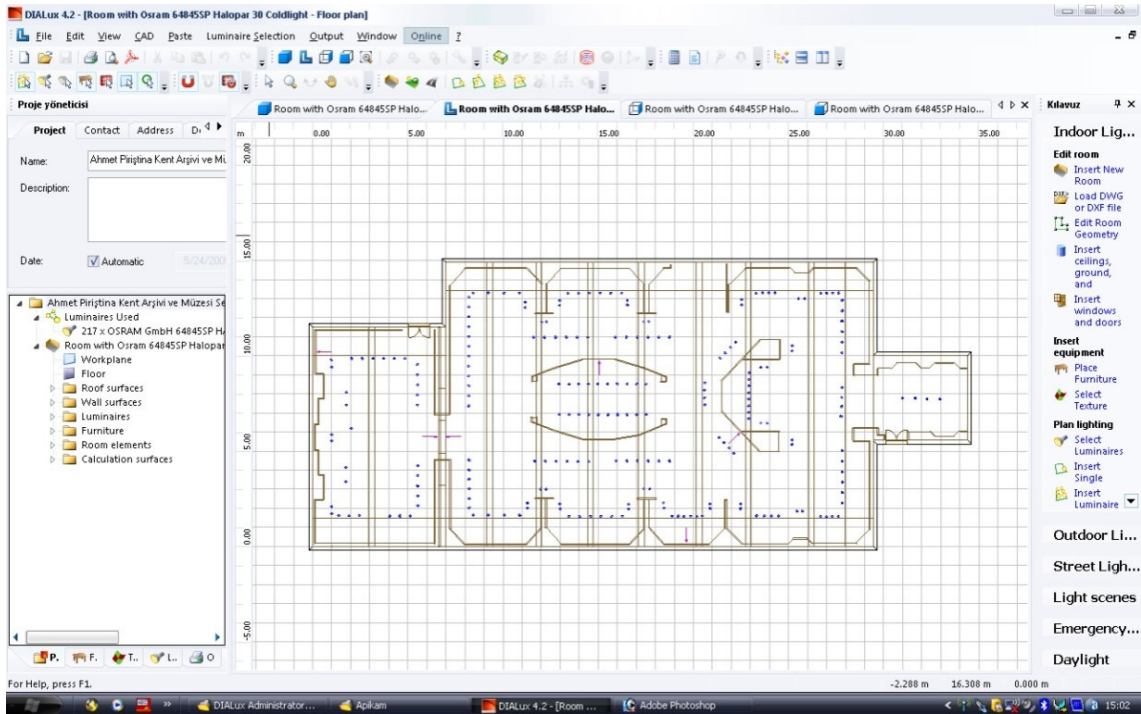

Figure 1.4. User interface of Dialux 4.2.0.5 (plan view)

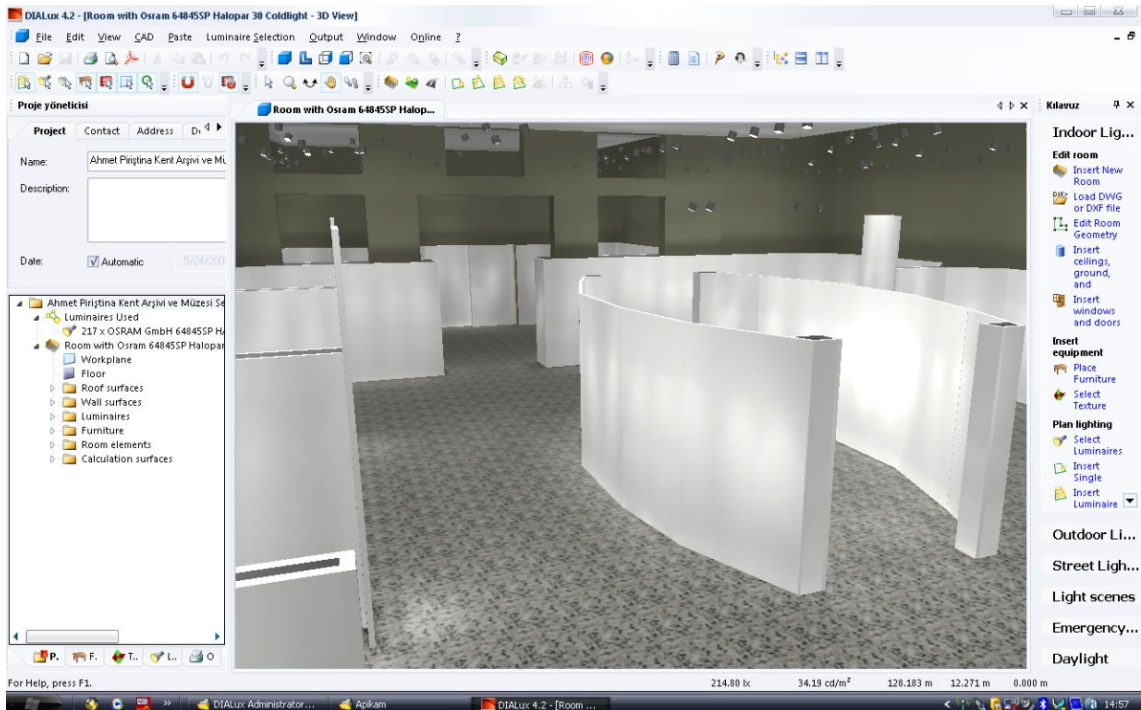

Figure 1.5. User interface of Dialux 4.2.0.5 (3D view)

In the following chapter the quality concepts will be discussed with ideas from different disciplines, such as lighting engineering, urban design, and architecture. The third chapter will explain the detailed structure of the evaluation methodology for artificial lighting quality. Fourth chapter concerns with the field study of APIKAM. Last chapter includes the results of the field study, general conclusions, and recommendations for further research.

CHAPTER 2

A REVIEW OF QUALITY CONCEPTS IN LIGHTING

Discussions about quality are complicated because of its intangible nature. One cannot measure quality in the same way one measures length or weight. There are varying approaches to measure quality in various disciplines. The importance here lies in developing criteria which are suitable to cover all the requirements or necessities of the relevant function. The term “quality” deals with the essential or distinctive characteristics or properties of something by judging it according to how much closer it stands to a grade of excellence or perfection. Hence mentioning quality is implicitly tantamount to a mention of a bunch of criteria of perfection. This state of perfection varies in relation to the function, context, and the requirements and needs of the user.

There are many different definitions available to describe quality with an aim of developing strategies to measure it. For example Fox (1993) defines quality as the processes and activities that need to be carried out to enable the manufacture of a product that fully meets customer requirements. It is possible to encounter numerous arguments similar to Fox’s. Three of these definitions are noteworthy because of their detailed structure and because they led to a system called “Total Quality Management” used in varying disciplines to improve the quality of the end-product. Actually they are more than a definition as they are acting as a management philosophy or a theory of organization and social process (White and Wolf 1995).

These three different definitions of quality were developed by W. Edward Deming, Joseph M. Juran, and Philip Crosby at the beginning of the second half of the twentieth century. Deming¹ suggested that the goal of firms should be constantly to improve their services and products for the customers. Juran² defined quality as fitness for use or the ability of a service or product to satisfy a customers needs (Choi and

1 Deming describes quality departing from some concepts such as uniformity, dependability and preferentiality. He suggests 14 points for quality management, which could be constituted as the basis for transformation of the American industry. Deming (1986) mentioned that these 14 points could be applied anywhere, to small organizations as well as to large ones, to the service industry as well as to manufacturing..

2 Juran (1964) says that techniques in controlling quality are far more developed than the ideas for managing the quality. He defines quality departing from two main points (Günaydın 2003):
Customer satisfaction
Elimination of defects

Eboch 1997). Crosby³ defined quality in connection with the concept of “zero defect” . Except Crosby’s all the definitions are substantially connected to customer needs in several ways. It is therefore vital to understand “customer needs” in order to be able to develop strategies to fulfill them for reaching excellence and thus good quality for certain functions.

Within this framework of identifying “customer needs” or “user needs” the task of lighting seems to be a difficult one. It constitutes a theme of two varying disciplines such as engineering and architecture which have generally opposite perspectives in finding solutions for a specific problem. It is necessary to take a look at their respective ways of manipulating the quality issue in lighting to find out the deficiencies before setting up the required criteria. In the following section the development of artificial engineering and its ways of manipulating quality will be discussed.

2.1. The Development of Artificial Lighting in the Twentieth Century. Lighting Engineering and Its Quality Definitions

After the invention of the light bulb by Thomas Edison in 1879, a new era for architecture had begun. Architecture gained a new character through the rising use of artificial light. Architects were excited about the new technology and they were willing to learn and use the capabilities of lighting techniques in their works. Soon artificial light became one of the important mediums for architecture with its expanding market, which made many things possible for a city at night.

Around the time when artificial light -based on electricity- was born and became a widely used tool for architecture for several purposes; modernism was becoming popular standing on a strong background leaning back to 1750s. Artificial light and its abilities for architecture, especially the one, that supplemented visual ability at night, were highly overlapping with modern philosophy and the spirit of the time (*Zeitgeist*). Modern doctrine come to stand for an illuminated world. That is quite explicit in Paul Scheerbarts (1914) manifesto “Glass Architecture” . Scheerbart was suggesting an

³ According to Crosby (1980):

- Quality means conformance, not elegance
- There is no such thing as a quality problem
- There is no such thing as the economics of quality; it is always cheaper to do the job right the first time.
- The only performance measurement is the cost of quality
- The only performance standard is Zero Defects.

architecture of glass, which let the light of the sun penetrate deep into the interior space. There was also an informal forum, such as the “Crystal Chain” that believed in an architecture revealed by light (Thomsen 1994). Comprising important names such as Hans Schroun, Bruno Taut, Walter Gropius, Wenzel August Hablik and Paul Gösch; this forum was highly effective in introducing the new understanding of modernism about light and its effects in architecture.

The twenties witnessed important innovations in the lighting industry. First of all, artificial lighting became cheaper with the accelerated technology. New and powerful lamps and electromechanical systems were developed. The newly discovered capabilities of light, such as advertising and orientation, were the motivating factors for the lighting field for carrying its industry a step ahead each day (Rub 1986). Besides all of these innovations in the lighting field in the twenties, a new profession called lighting engineering appeared and established its own world of terminology, which was mostly defined by engineers and technical specialists.

Some attempts in the lighting field concerning public security were made in these years, such as the lighting of the streets and boulevards in big cities. These attempts are important for showing the general attitude of lighting engineers for determining their priorities to illuminate the city. Diggs (1933) pointed out that after San Francisco had increased lighting on Bay Shore Boulevard in 1933, the nighttime accident rate dropped by 40 percent in the first six months. Carr (1973) reported that after Gary, Indiana, upgraded its entire street lighting system, the number of reported criminal assaults declined by more than 70 percent.

Street lighting parameters were first established in 1914 by the National Electric Light Association and the Association of Edison Illuminating Companies in the United States. The primary purpose of lighting was to illuminate (Harrison et al. 1930). Another purpose of lighting was an orientation in order to serve for advertising needs (Rub 1986). In 1925, the Illuminating Engineering Society (IES), which is still the principal forum for setting lighting standards, set the scientific principals for street and highway lighting (Tien 1979). These standards derived from two main requirements as follows:

- To supply visual ability for basic activities at night
- To supply security in public areas

These were the first standardization attempts for lighting design and during the twentieth century they became more complex as the field grew larger. The main development in this approach at the end of the century is the fragmented characteristic of it. Lighting engineering today handles a city or a building complex in sub-categories deriving from the functional criteria, such as roads, walkways, trading areas, business areas, dwelling areas; or living rooms, bedrooms, study rooms, etc. It is possible to refer to a handbook for each varying functional area of a city or part of a building which suggests quantitative solutions for lighting problems. Table 2.1 shows the recommended light levels for varying functions.

Generally in the lighting engineering community, good lighting means a visual environment that enables peoples to see, to move safely and to perform visual tasks efficiently, accurately and without causing certain disabilities such as visual fatigue and glare. Although mentioning some quantitative aspects such as luminance distribution and color rendering; lighting engineering has a tendency to overcome the quality issue in a quantitative way through set of regulations.

Today each lighting problem reaches a solution through lighting master plans, prepared mostly by lighting engineers who respect the IES's regulations. The lighting or electrical engineer is given the responsibility for the lighting, and follows generally the lumen method for illuminating interior and exterior (Lam 1992). Kay (1996: pp. 71-72) discusses the steps in the lumen method as follows:

From IES Handbook, from government codes, or from the client's specifications, determine the required average level of horizontal footcandles for the project. A single level may be specified for the entire building, or various levels may be established for different types of space: office, classroom, corridor, etc. Select a lighting fixture or fixtures suitable for mounting in the preselected ceiling system, which uses the most economical lamps available and has the highest fixture efficiency in terms of producing illumination on the horizontal plane at desk level. The shape of the fixture relative to that of the room is usually considered to be a secondary importance, if it is considered at all. Some consideration is given to quality of the lighting system by limiting direct glare, generally however, low-brightness fixtures will not be selected, if they cost more per footcandle delivered on the work plane. Calculate the number of fixtures required to achieve the average illumination level or level determined in step 1. Find a layout for the required number of fixtures which distributes the light uniformly over the room as measured at the work plane.

Table 2.1. Recommended Lighting Levels
(Source: WEB_1 2002)

Task Area	Lighting Level [fc]
Corridors/Stairways/Restrooms	10-20
Storage Rooms	10-50
Conference Rooms	20-50
General Offices	50-100
Drafting/Accounting	100-200
Areas with VDTs	75
Classrooms	50-75
Cafeterias	50
Gymnasiums	30-50
Merchandising	30-150
Manufacturing Assembly	50-500
Parking Areas (uncovered)	1-2

The Campus of the University of Iowa implemented a lighting master plan in 1996. Three main goals were described in the Campus Lighting Master Plan Strategy Book (1999):

- To provide sufficient levels of illumination at building entrances and along routes between campus buildings, parking lots, bike racks, bus stops, campus entrances, and isolated areas so that the pedestrians, drivers, bicyclists, and other users can travel safely at night.
- To balance energy efficiency and cost issues with other goals.
- To minimize the nuisance effects of light pollution.

Here, all goals are noteworthy as being entirely connected to quantitative basics as lighting levels, and cost issues.

Julian (1995) claims that the concept of quality in the field of lighting can be generally thought of as determined by three major aspects. In order of importance these are:

- Safeguard the safety of people in the interior.
- Facilitate the performance of visual tasks.
- Aid the creation of an appropriate visual environment.

According to Kampf (2005) successful lighting design is one which saves energy, saves money, improves visual comfort, decreases maintenance, and reduces waste. He adds that in order to reach good lighting solutions one should consider the budget, light levels, light sources, lighting controls, color rendering index, and color temperature.

Lighting engineering, as being the one and only authority in illumination decisions, also affected other disciplines in terms of lighting in theory and practice, such as urban design. This is remarkable because urban design has roots in the social sciences more than in engineering and thus bears a qualitative approach to research. Although there are some exceptions such as the ideas of Lynch (1960), who introduced the concepts of “variety in illumination” , “warmth achieved through illumination” , and “spatial mood created by illumination” urban design preferred to import the quantitative lighting vocabulary from lighting engineering. Urban designer Boduroğlu (2001), for example, points out that lighting should consider some basic criteria such as:

- Providing security.
- Providing easy access.
- Providing orientation.
- Providing minimum requirements for night-time activities such as sports, etc.

2.1.1. Models in Lighting Engineering Used to Define Quality of Lighting

As Boyce (1981) pointed out there have been two approaches to lighting research; practical study and the laboratory study. The laboratory studies have had greater effect on lighting practice because of their role in the establishment of lighting standards and codes. Field studies generally led to misinterpretations in the relationship between illumination and task performance. The best known study is the Hawthorne Experiment (1924-32), which demonstrates the difficulty in conducting field studies. The aim of these studies was to clarify the relationship between productivity and lighting as one of the environmental factors. The main conclusion was that there was no real connection between environmental factors and productivity, since productivity had been increased under all varying lighting installations. Later in the seventies, these studies were proved untrustable, because of the awareness of the participants that they were subject to a research. This phenomenon took its place in the literature of psychology as “Hawthorne Effect” .

Lighting engineering, especially in the last quarter of the twentieth century, attempted to develop some models in order to fill the gaps in their definitions of quality. Some, such as Visibility Level (VL), Comfort Satisfaction and Performance Index (CSP), Relative Visual Performance (RVP), Equivalent Sphere Illuminance (ESI), were primarily indices of quantity, rather than quality. Others, notably Visual Comfort Probability (VCP), addressed quality but in a limited way (Veitch and Newsham 1996).

2.1.1.1. Visibility Level Model (Blackwell, 1959)

In an attempt to assess the level of visibility that an individual has for a specified target, Blackwell believed that a comparison was necessary between a predetermined standard and that of the individual perceiving the specified target (Torrez 2003). According to Blackwell, the visual difficulty of any task can be express as a single quantity, which he called visibility level (VL). In Blackwell's model each task was to be compared to a reference task to determine its visibility in terms of revealed contrast.⁴ The reference task is the detection of a luminous disc, which is viewed for 0.2 seconds. Observers were initially required to view a uniform screen with a standardized level of illumination. At this point, the luminous disc was presented at the center of the screen in pulses of 0.2 sec and the observer was allowed to adjust the physical contrast of the disc until they perceive it as barely visible (Torrez 2003).

The standard curve used in the visibility model was constructed from a population of 20-30-year-olds with normal or corrected-to-normal vision, and the reference illumination is diffuse white light with color temperature of 2850 K. Visibility level was calculated as the ratio of the threshold contrast of the task to the threshold contrast of the standard luminous disc, which was determined using a special device, the visibility meter (Levy 1978).⁵

⁴ According to Blackwell (1959), visual difficulty of any task can be express as a single quantity, which he described as Visibility Level (VL). $VL = \text{equivalent contrast} / \text{threshold contrast}$.

⁵ In calculating visibility level (VL), the researcher places the target (reading material or other task material) in to the visibility meter and sets the background luminance for the level under which the task is normally performed ($C(Lt)$). The observer then adjusts a knob that controls a mechanism to cast a veiling luminance (L_v) over the task until it is just barely visible. The target is then removed and the disk is presented. Under the same veiling luminance which is set before, the observer now changes the background luminance until the disk I just barely visible to give the equivalent contrast $C(eq)$. Visibility level is calculated using the formula: $VL = C(eq) / C(Lt)$

The model proposed by Blackwell was soon recognized for its insufficiency in forming response to a variety of tasks (Brass, 1982). The VL represents visibility under very special conditions that do not exist outside a visibility meter. The light was unpolarized, diffuse, of a particular color temperature, and produced with uniform luminance at all parts of the task (Veitch and Newsham, 1996). Additionally, the model of visibility level was judged for its lack of realism where under the controlled conditions it applied to only perceptible points of light, but did not encompass the complex, practical tasks that are involved in how and what we see (Brass 1982).

2.1.1.2. Equivalent Sphere Illuminance (ESI)

Sphere illumination is a standard reference condition with which the actual illumination can be compared. In sphere illumination the task receives light from a uniformly illuminated hemisphere. Since the task is illuminated from all directions, no veiling reflections can occur (Lechner 1991). Sphere illumination is such an exceedingly valuable concept not because it represents the best possible lighting, but because it is a very good reproducible standard with which any actual lighting system can be compared (Lechner 1991).

ESI was developed in the seventies and the goal was to develop a way to specify both quantity and quality using a single value to describe the lighting requirement for a given task. Generally ESI is the measure of visibility that takes both illuminance and contrast into account. This is useful in determining the effectiveness of controlling veiling reflections. The steps below describe, in general terms, how ESI can be measured in rooms (Egan 1983).

Step 1 (Figure 2.1):

Under a hemispherical source, measure brightness of task L_t and background L_b . Contrast C is related to task and background brightness as follows:

$$C = (L_t - L_b) / L_b$$

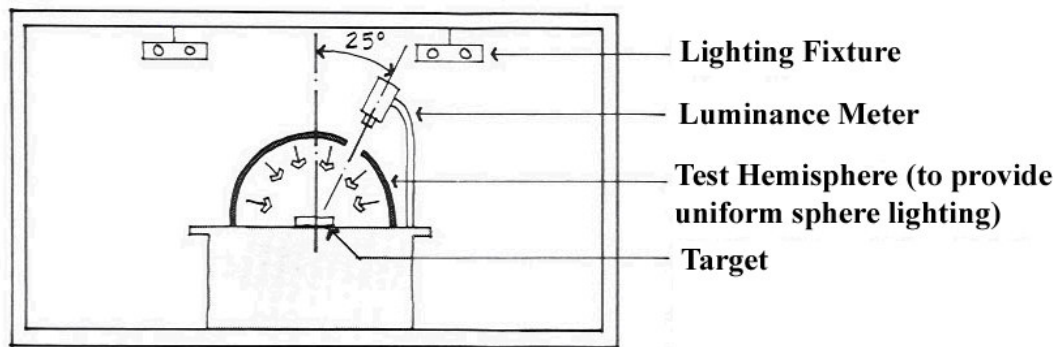

Figure 2.1. Measurement of ESI - Step 1
(Source: Egan M. D 1983)

Step 2 (Figure 2.2):

Under actual lighting conditions, again measure brightness of task and background to establish contrast.

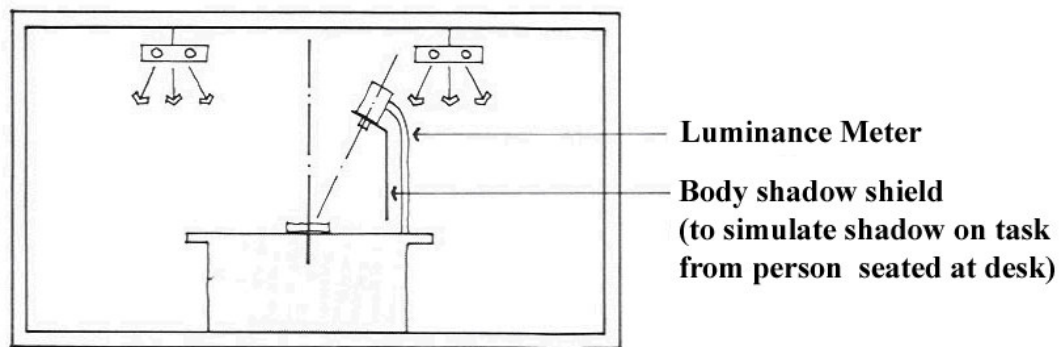

Figure 2.2. Measurement of ESI - Step 2
(Source: Egan M. D 1983)

Step 3:

The contrast rendition factor (CRF) is the ratio of contrasts found by steps 1 and 2. The ESI for a position in a room is determined by the CRF, the location, distribution, and the size of light sources; the room dimensions and reflectances; and the light distribution characteristics of the fixtures.

ESI footcandles can tell us how effective the illuminance in a room is. An actual lighting system that supplied an illumination of 250 footcandles might be no better than an equivalent spherical illumination of 50 ESI footcandles (Lechner 1991). That means that the quality of the actual system is so poor that 200 out of 250 footcandles are noneffective for the task.

As a derived value, ESI had several drawbacks (Boyce, 1978). Although it was based upon visibility data, these data did not represent the visual tasks people typically

perform. People generally look at objects with features from which the visual system constructs meaning (i.e., faces or letters), rather than luminous discs which do not carry any information. The calculation process depends on an assumption that all viewing is static and on-axis, whereas the human eye obtains much information from the periphery of the visual field, and often views moving objects (Boyce, 1978). Another problem, seldom mentioned in the literature, is the limited range of reference tasks for which CRF curves were developed. As a matter of fact, in ESI, CRF is specific to a given task, which is writing on paper with pencil. Further, CRF data for widespread applications to other kinds of tasks was never available.

2.1.1.3. Visual Comfort Probability (VCP)

While VL and ESI systems were based principally on visual performance, visual comfort probability (VCP) was developed to address discomfort glare. VCP is the probability that an observer will consider a given visual environment comfortable for performing a task. It can also be considered the percentage of observers who consider a visual environment comfortable in those conditions. A VCP rating of 75, for example, indicates that 75% of the observers in the poorest location would not be bothered by direct glare. A VCP of 70 percent is considered acceptable by IES Standards. The experimental work predicts discomfort glare ratings (DGR) from luminous conditions: source luminance, luminances in the field of view, the visual size of the glare source, and the location of the glare source in the field of view.⁶

Neither ESI nor VCP alone were developed as a complete specification of lighting quality: ESI addressed quantity and veiling reflections from a visibility standpoint, and VCP addressed discomfort glare. Herst and Ngai (1978) suggested that the two values could be combined to yield a value they called a Lighting Quality Index (LQI). The LQI was to be calculated on the basis of VCP and ESI maps of a space: LQI

⁶ The method has been developed by Guth (1963) with this following formula:

$$\text{Glare Sensation (M)} = 0.5 * L_s * Q / P * F^{0.44}$$

L_s is the luminance of the glare source (cd/m²),

P is an index of its position with respect to the line of sight,

F is the average luminance of the entire field of view including the glare source (cd/m²),

Q is a function of the solid angle ω_s that subtends the source in the observer's eye:

$$Q = 20.4 \omega_s + 1.52 \omega_s^{0.2} - 0.075$$

To obtain the glare level for a number of glare sources in an installation the glare sensation values are summed using the following equation to obtain a value for the DGR. ($\text{DGR} = (\sum M)^n^{-0.0914}$).

N is the number of glare sources in the visual field.

is the percentage of the space meeting the minimum criteria for both VCP and ESI. Although this approach was intuitively attractive to some, it never gained a wide following, probably because of the problems inherent in the ESI system (Veitch and Newsham 1996).

2.1.1.4. Comfort, Satisfaction, and Performance (CSP) Index

The CSP Index was developed by Bean and Bell (1992) to predict the probability that office workers will be satisfied with the visual environment provided for them. It is conceptually similar to the VCP system. However, its development followed a different path.

In this model, comfort index is based on glare index; satisfaction is predicted from cylindrical and horizontal illuminance. Performance is derived from horizontal and cylindrical illuminance, illuminance uniformity, and color rendering. All of them are equal in calculating the CSP index. Figure 2.3 shows the derivation of CSP.

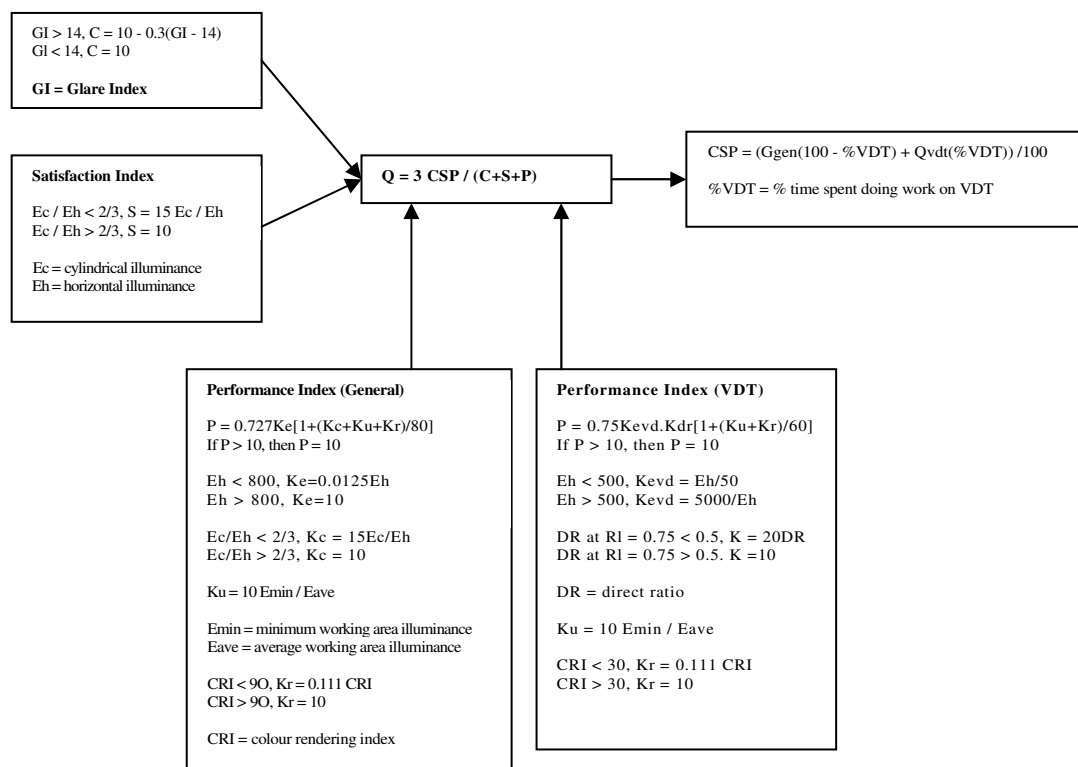

Figure 2.3. Derivation of CSP Index

(Source: Bean and Bell 1992)

2.1.1.5. Relative Visual Performance Model (RVP)

RVP is the percentage that an individual can perform for a given task with a particular lighting system. For a task of a particular size and type to be done by certain age individuals, both the background luminance and task contrast are taken into account. Two lighting systems can be compared by calculating the RVP for each with the same task and age of individual specified. The lighting system with the higher RVP percentage would provide better quality lighting for the given task.

RVP was developed by M. Rea and M. Ouellette, and mainly aimed at overcoming deficiencies in previous models such as Visibility Level of Blackwell. RVP describes visual performance in terms of target contrast, size, and adaptation luminance and includes modifiers for viewers of varying ages between 20 and 65 years (Veitch and Newsham 1996). Figure 2.4 is a graphic representation of RVP model.

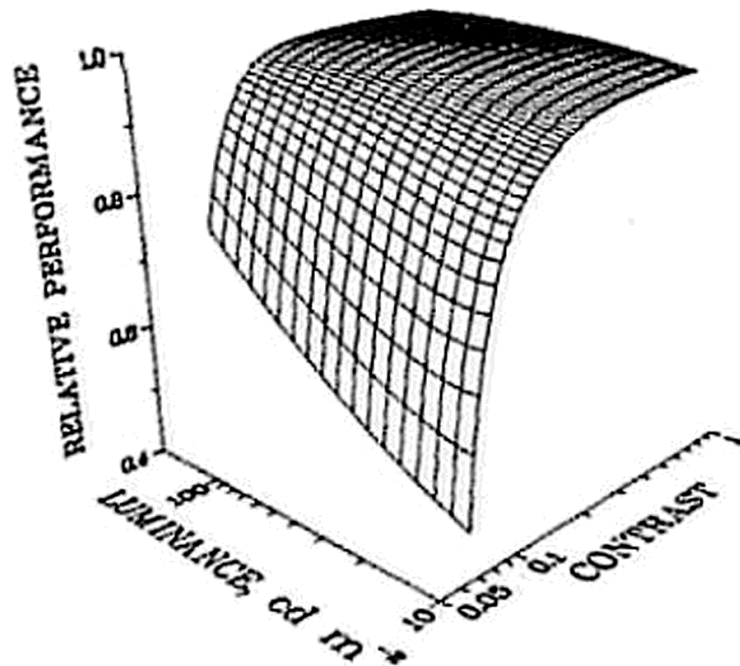

Figure 2.4. Graphic representation of the RVP Model
(Source: Rea and Ouellette 1991)

In this model observers are presented with two lists of five digit numbers that are arranged alongside the columns in a room. Then they are asked to identify any differences between the adjacent pairs and after recognition, they should mark their answers in response sheets. The contrast and background luminance of the test sheet

was adjusted throughout the procedure, but the target size remained constant (Torrez 2003). In this study, the main element of mathematical measure for the development of the successive model was the speed and accuracy of recognition and detection. The model also included the issue of age. The neurological problems that occur with age were analyzed and considered in the creation of this model.

2.2. A Qualitative Way in Defining Quality in Lighting from the Architectural Point of View

The difference between positivist sciences and non-positivist sciences is in the methodology they use in research. Lighting engineering, as a positivist science, prefers a quantitative research methodology under a belief that anything could be measured, understood, and generalized about, while neglecting interpretation of non-numerical data, such as experience, feelings, and spatial dynamics with their relation to lighting properties.

The simplest way to define qualitative research is to propose that it is a type of research which includes interpreting non-numerical data. According to Gay and Airasian (1996), the underlying belief of qualitative research is that meaning is situated in a particular perspective or context, and, since different people and groups have different perspectives and contexts, there are many different meanings in the world, none of which is necessarily more valid or true than another. Chappell (WEB_2 2005) adds that a qualitative researcher, therefore, believes that the world cannot be pinned down to objective meanings, but that all variables must be taken into account when conducting research. Table 2.2 shows the differences between quantitative and qualitative research.

While the quantitative aspects of light are very well known (it has been the major determinant factor for lighting design), the qualitative aspects are not very well defined nor known. Besides supplying well defined visual abilities, lighting must also cover architectural requirements and create appropriate spatial dynamics in respect to human psychology. Lighting occurs and always should be integrated in an architectural context. High-quality lighting is responsive to the architectural form, composition, and style. The integration with the architecture conveys meaning and contributes to the observer's understanding of the space. It is light that first enables spatial perception.

Above and beyond this, our perception of architecture can also be influenced by light, as it expands and highlights rooms, creates links and distinguishes one area from another. Light can alter the appearance of a room or area without physically changing it. Light directs our view, influences perception and draws our attention to specific details. Light can be used to divide rooms in order to emphasize areas or establish continuity between the interior and exterior. Light distribution and illuminance have a decisive influence on how architecture is perceived.

Architectural space is born from the relationship between objects or boundaries and from planes which do not themselves have the character of object, but which define limits (Von Meiss 1990). Space would be a limitless void without some sense of enclosure or visual reference that communicates a sense of place (Michel, 1996). A composite set of boundaries at any place comprises the spatial envelope, a working mechanism for the design, analysis, and lighting of architectural space and this spatial envelope carries the dominant areas of stimuli for visual perception, and thereby establishes the major surface planes forming the physical limits of space as seen by human vision (Michel 1996).

Architectural space exists by the illumination of objects and enclosing surfaces. Von Meiss (1990) comments that architectural design could be considered the art of placing and controlling light sources in space. Light has a reciprocal relation with form, structure, and other basic components of space. Light illustrates form and structure, and

Table 2.2. Differences Between Quantitative and Qualitative Research
(Source: WEB_2 2005)

Characteristic	Quantitative Research	Qualitative Research
Approach	deductive	inductive
Purpose	theory testing, prediction, establishing facts, hypothesis testing	describing multiple realities, developing deep understanding, capturing everyday life
Research Focus	isolates variables, uses large samples, is often anonymous to participants, uses tests and formal instruments	examines full context, interacts with participants, collects data face-to-face from participants
Research Plan	developed before study is initiated, structured, formal proposal	Begins with an initial idea that evolves as researcher learns more about participants and setting, flexible, tentative proposal
Data Analysis	mainly statistical, quantitative	mainly interpretive, descriptive

these spatial components define its physical limits and quality in space. Architecture depends on light. As light reveals the forms of architecture and the places made by it, it simultaneously reveals the meaning and the intentions that are released through the process of conceiving, designing, and building (Millet 1996).

Light and architecture have a mutual relationship which is hard to define and which is only possible to understand by experiencing the effects of light on spatial creations. Some headings below may help to form an insight into the peculiarities of light in architecture:

- The interaction of light and structure
- Light as a stressing element on structure
- Light as a concealing element on structure
- Relating spaces through light
- Connecting spaces through light
- Separating spaces through light
- Differentiating spaces through light
- Light as a means of direction
- Light that creates a focus in space
- Light that encourages movement
- Light and its effects on form
- Light and its effects on texture
- Light and its effects on spatial mood
- Light and its effects on perception

These peculiarities of light which are essential in creating the sense of place in architecture may be increased in number. As Cullen (1986) says, light determines how we perceive our environment. And if carefully studied and successfully applied, lighting can play an integral role in creating architecture (Theodore and Bradshaw 1994).

There is a remarkable difference between architecture and other disciplines such as lighting engineering in defining the term “quality” . As Kay (1996) discusses, engineers say that one of the factors that affects quality in lighting is the uniform distribution of it. However, it is not, from the architectural point of view. Von Meiss (1990) mentions “light-space” , which is an imaginary space created when a portion of

space is well lit while the rest is left in semi- or total darkness. The limits are imaginary but perfectly perceptible. He adds that the light-space is very useful in architectural design since it makes it possible to present scenes as in the theatre, circus or museum; also enables the person who is in the illuminated area to isolate himself and concentrate better. Its in the interior of Pantheon in Rome, where it is not possible to observe a uniform illumination. Sunlight penetrating from the oculus above and moving according to the movement of the sun, creates a spotlight effect and illuminates the sculptures placed in the circular wall of the Pantheon (Figure 2.5). According to Gordon (1987) non-uniform lighting helps to establish the relative strength of visual symbols, and therefore the organization of brightness patterns is a fundamental consideration in defining visual space (Figure 2.6 and Figure 2.7).



Figure 2.5. Pantheon, Rome
(Source: WEB_3 2006)



Figure 2.6. Unlike the walls, the object in the middle of space receives uniform illumination which makes it appear dull and uninteresting. (Source: Erco 1999)



Figure 2.7. With the help of two spotlights the same object became a focal point in the space. (Source: Erco 1999)

In the illuminated world of architecture, shadows also seem to be forgotten. Arnheim (1977) says that shadow is light's counterpart and reflects on the three dimensional form of the body. If the lighting is uniform, coming from all sides, the object becomes flatter (Von Meiss 1990).

Lighting quality from the architectural point of view is defined not only by quantitative parameters such as the amount of light, or light's ability to set up required conditions for seeing; but also with its ability to add new dimensions to the life and experience in space. Next chapter will form a frame to assess quality of lighting considering several variables which are effective in spatial dynamics created through lighting as discussed in this chapter.

CHAPTER 3

THE STRUCTURE OF THE EVALUATION METHODOLOGY FOR ARTIFICIAL LIGHTING QUALITY

Based on a qualitative research tradition described before, and the existing literature on lighting quality, a conceptual framework was designed. It is proposed that lighting quality could be defined when the luminous environment supports the following requirements of the people who will use the space. One also could add further aspects to this list by considering different needs:

- Visual performance and safety;
- Task performance;
- Behavioral effects other than vision (attention, spatial hierarchy, phototropism)
- Mood state (pleasure, happiness, alertness, satisfaction, dominancy);
- Human physiology and health;
- Aesthetic judgments;
- Others.

Lighting quality, according to these parameters, is not directly measurable, but is a state created by the interplay of the lit environment and the person in that environment. Good lighting quality exists when a lighting system:

- Creates good conditions for seeing and safety;
- Supports task performance;
- Sets appropriate conditions for behavioral outcomes;
- Supports appropriate mood state in space;
- Provides good conditions for human physiology and health;
- Contributes to the aesthetical quality of the space;
- Others.

Deriving from these propositions three groups of aspects could be formed which together constitute a base for determining lighting quality (Figure 3.1). These are:

- Functional Aspects
- Physiological Aspects
- Psychological Aspects

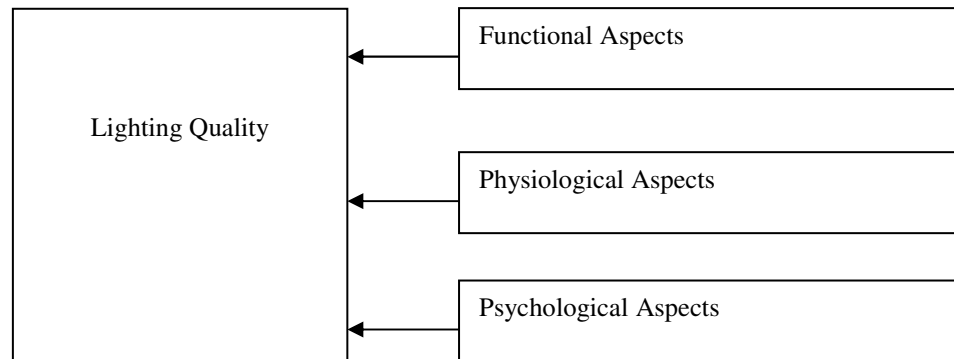

Figure 3.1. Three Aspects of Lighting Quality

3.1. Functional Aspects

As is widely known, in the lighting field each function such as office, classroom, living room, restaurant, museum, etc. requires different lighting solutions. Functional aspects are mostly concerned with visibility, thus safety; and with task performance in relation to the amount of light, lighting systems or lamp types chosen. Functional aspects check whether they are appropriate to the desired function or not. Functional aspects (Figure 3.2) include as well the color temperature of light in relation to varying lamp types chosen for varying spatial functions. The distribution of light throughout the space also effects visibility and task performance.

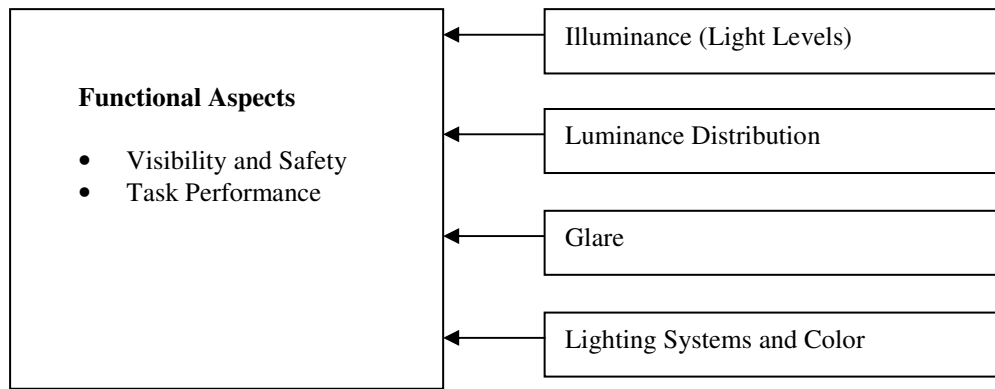

Figure 3.2. Determinants of Functional Aspects

3.1.1. Visibility, Safety and Task Performance

Illuminance: Illuminance is the technical term for the quantity of visible radiation incident on a surface, mostly known as “light levels” (Gligor 2003). Illuminance is measured in lux, or lumen per square meter (lm/m^2). The illuminance and its distribution on the task areas and the surrounding area bear a major impact on how quickly, safely and comfortably a person perceives and carries out the visual task.

There is a general consensus between lighting researchers and the American and European standards in illumination levels recommendations. Both of the standards recommend values of 300 lx to 500 lx for the desktop illuminance for a reading task. Also, the visual preferences of users will change in time depending on season or will be different for different genders. Laurentine et al. (2000) found that if 300 lx are usually a minimum value for an office task in the summer time (the lighting on the desk and lighting environment were rated as “unpleasant” but the tasks were performed correctly), the preferred artificial light level is much higher in winter time, the difference between warm and cool season rising to almost 300 lx. O’Donnell et al. (1999) found that in subtropical regions the need for lighting is higher, by a rate of 500-700 lx.

According to the European standards minimum lighting values shall not be less than 200 lx in areas where continuous work is carried out. In normal conditions approximately 20 lx of horizontal illuminance is required just to detect features of the human face (WEB_4 2005).

Despite the results of Hawthorne Experiments, there is a general tendency in the lighting field for more light. This owes to a belief that more light leads to better work. However, the decision should be made according to the varying requirements of varying

contexts. According to Gligor (2003) the illuminance should be increased when unusually low contrasts are present in the task, visual work is critical, errors are costly to rectify, accuracy or higher productivity is of great importance, the visual capacity of the worker is below normal. He adds that the required maintained illuminance may be decreased when the details are of an unusually large size or high contrast and the task is undertaken for an unusually short time.

There are numerous scientific works that seek the relation between illuminance and task performance, but they have reached inconsistent results. Hughes and McNelis (1978) reported that an increase in illuminance from 500 to 1500 lx caused an average 9 percent increase in the productivity of office workers during a difficult paper-based task. Baron et al. (1992) however, found that lower illuminance levels (150 lx) tended to improve performance on a complex word categorization task as compared to high levels (1500 lx). Nelson et al. (1983) found that performance on a difficult task was best under 80 lx, worst under 160 lx, and intermediate under 320 lx. There were no illuminance effects on reading or spatial relations tasks. Smith and Rea (1982) found no effect of illuminance levels on reading comprehension over a wide range (9.2 to 4540 lx). Nelson (et al. 1984) found no effect of illuminance levels of 100 and 300 lx on creative writing performance. Kaye (1988) compared task performance under 500 and 1200 lx and found no effects on visual search tasks. Looking at these results it is possible to say that there is no clear connection between illuminance and performance. This variable should be discussed for each context separately, with respect to user preferences.

Luminance Distribution: Luminance (also called *luminosity*) is a photometric measure of the density of luminous intensity in a given direction. It describes the amount of light that passes through or is emitted from a particular area. The unit for luminance is candela per square meter (cd/m^2). Luminance is often used to characterize emission or reflection from surfaces. The luminance indicates how much luminous power will be perceived by an eye looking at the surface from a particular viewpoint. Luminance is an indicator of how bright the surface will appear. To create variance in luminance distribution means to create a pattern of very light, light, semi-light, and dark areas within a space. The desired point should be that this pattern allows occupants to see what they want and creates the desired atmosphere.

The luminance distribution in the field of view controls the adaptation level of the eyes, which affects task visibility. According to Gligor (2003) a well-balanced adaptation is

needed to increase visual acuity (sharpness of vision), contrast sensitivity (discrimination of relatively small luminance differences), efficiency of the ocular functions (such as accommodation, convergence, pupillary contraction, eye movements, etc.).

Diverse luminance distribution in the field of view (task surface, e.g. a work desk, a painting on the wall) also affects visual comfort and should be avoided. Too high luminances can give rise to glare; too high luminance contrasts will cause fatigue due to continuous re-adaptation of the eyes; too low luminances and too low luminance contrasts result in a dull and non-stimulating working environment (IESNA 2000).

The illuminance of immediate surrounding areas shall be related to the illuminance of the task area and should provide a well-balanced luminance distribution in the field of view. Rapid spatial changes in illuminances around the task area may lead to visual stress and discomfort (Gligor 2003). Sounders (1969) found that illuminance ratios lower than 0.7 caused a substantial increase in dissatisfaction. Luminance ratios of 1:1 are considered optimal in North America, with 3:1 (task brighter than surrounding area) being acceptable (Rea 1993). Both IESNA and CIE propose only that luminance ratios higher than 10:1 are needed to achieve dramatic effects, such as to highlight an architectural feature or to add interest to the space. However, Veitch and Newsham (2000) found that the degree of desirable luminance variation might be greater than current recommendations. In their study, participants were exposed to luminance ratios from 11:1 through 68:1. The study concluded in an upper limit of ratio of 20:1, which satisfies all the subjects' visual requirements for the relevant task.

Glare: Glare is the visual sensation produced by bright areas within the field of view and may be experienced either as disability glare or discomfort glare. When the background illuminance is low relative to the source, objects near the source become invisible or it gets difficult to see them. This type of glare is known as disability glare. In some cases the illuminated field is brighter than one can adapt to, such as the sunlight reflected by snow. This type of glare is called discomfort glare. In simple terms discomfort glare is glare which causes discomfort, without leading to a decrease in vision. In contrast, disability glare may not cause any discomfort but leads to some or total loss in vision. Glare may also be caused by reflections on surfaces usually known as veiling luminance or reflected glare. Veiling reflection is usually caused by locating a luminaire directly above or slightly in front of a work station. Repositioning of the luminaire or task, or using special polarized lenses will solve that problem.

It is possible to eliminate glare by increasing the angle between the source and the line of sight. Figure 3.3 and Figure 3.4 show this angular separation between target and glare source. The perception of glare is different from person to person. In general, women are more glare sensitive than men and older people are more glare sensitive than younger people (Figure 3.5) (Laurentine et al. 2000).

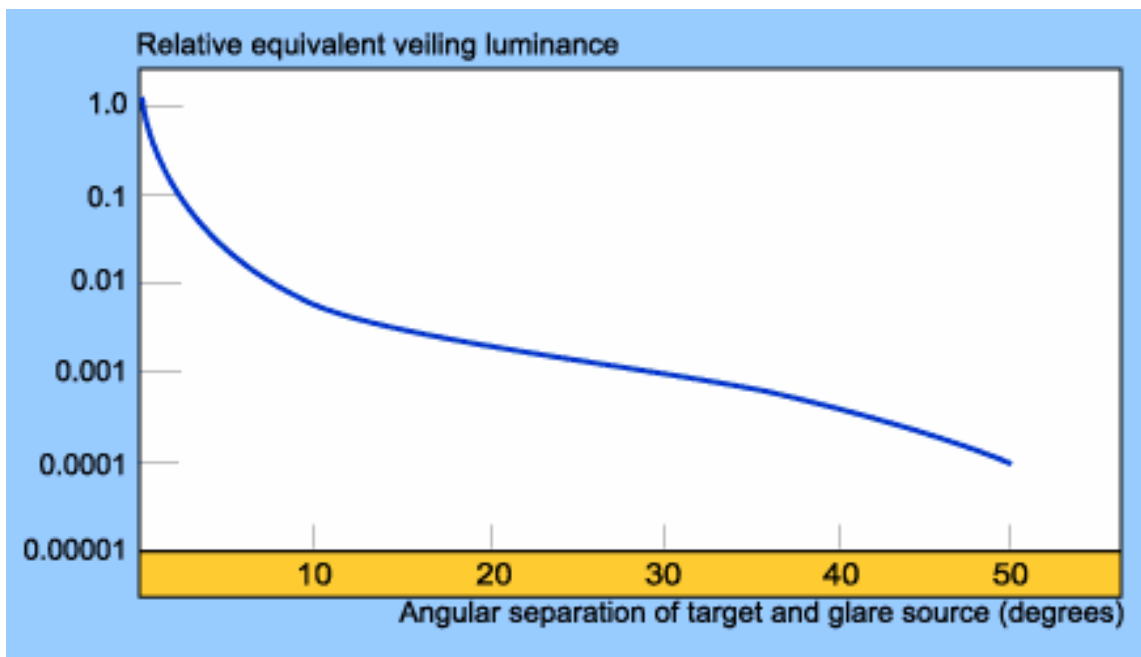

Figure 3.3. Relationship between equivalent veiling luminance and angular separation between line of sight and glare source. (Source: WEB_5 2005)

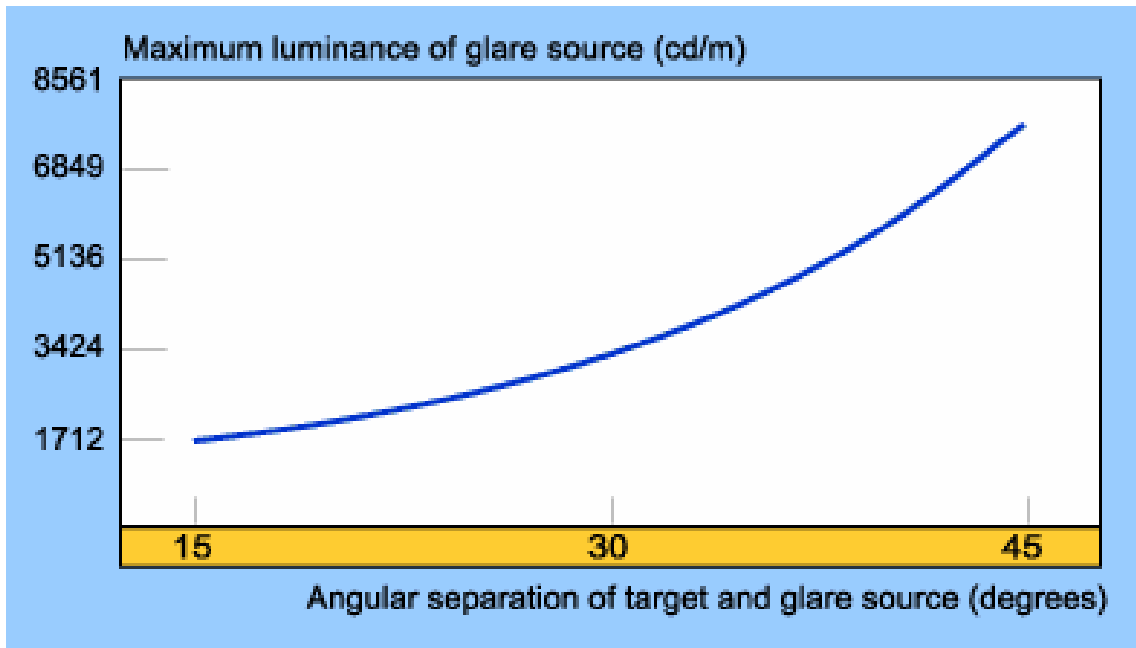

Figure 3.4. Relationship between maximum luminance of glare source and angular separation between line of sight and glare source (Source: WEB_5 2005)

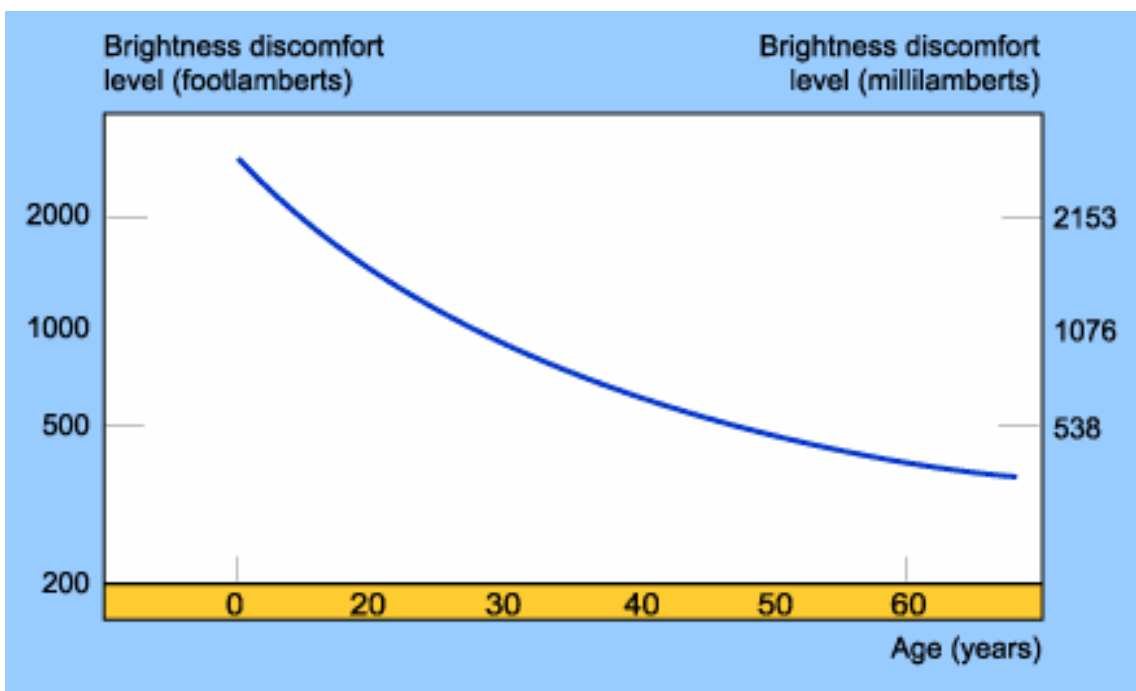

Figure 3.5. Age and sensitivity to brightness (Source: WEB_5 2005)

Several attempts have been made to develop predictive models, such as Visibility Level Model (VL), and Visual Comfort Probability (VCP), which will help to form some regulations for eliminating glare problems.

Visual display terminals (VDT), such as computer monitors in an office or plasma screens in a contemporary art museum present special problems for lighting design in terms of glare. Unlike conventional tasks such as a horizontal desk in a library, VDT is a self-luminous, vertical task. Lighting, which is suitable for a conventional horizontal task, becomes a veiling luminance on a VDT. Careful selection and placement of luminaries is required to avoid the reflected luminaire images on the screen, which reduce visibility and cause discomfort.

Lighting Systems and Color: We experience our surroundings not just as brightness and darkness, light and shadow, but also in color. Color appearance is the color temperature⁷ of a certain color of light (or wavelength) in Kelvin (K). Color Rendition Index (CRI) is a measure of how well a source renders colors compared to a natural light source. The higher the color temperature of a light source, the more blue it has in its spectral distribution. Discussions of lighting and color typically fall into two categories as the color appearance of the light source itself and the color appearance of various objects when they are illuminated by the light source

Lamps have good color rendition if, when illuminating a comprehensive range of colors they produce the least possible change in color effect in comparison to a standardized light source of similar color temperature (Ganslandt 1995). Thus every statement about the quality of color rendition refers to a particular color temperature and an equally valid color rendition value for all color temperatures does not exist. The color rendition of a light source depends on the construction of the specific lamp spectrum, whereas the quality of color rendition depends on the greatest possible continuity of the emitted spectrum. For color temperature the distribution of light output in the spectrum is decisive. If the light emitted is in the long wave, in red area of light, the result is a warm white light source, while the short wave end of the spectrum the color temperature is cooler. With incandescent lamps, this distribution is directly

⁷ The light color of a lamp is expressed in terms of color temperature T_c measured in degrees Kelvin (K). The Kelvin temperature scale begins at absolute zero (0 Kelvin \approx -273°C). Color temperature is used to denote the color of a light source by comparison with the color of a standardized "black body radiator". A black body radiator is an "idealized" solid body, e.g. made of platinum, which absorbs all the light that hits it and thus has a reflective radiance of zero. When a black body is slowly heated, it passes through graduations of color from dark red, red, orange, yellow, white to light blue. The higher the temperature is, the whiter the color. The temperature in K at which a black body radiator is the same color as the light source being measured is known as the correlated color temperature of that light source. An incandescent lamp with its warm white light, for example, has a correlated color temperature of 2800 K, a neutral white fluorescent lamp 4000 K and a daylight fluorescent lamp 6000 K (Fraser and Banks 2004).

dependent on the filament temperature, which explains the term “color temperature” . With discharge and fluorescent lamps, on the other hand, light temperature depends on the filling and coatings used. Figure 3.6 and Figure 3.7 show the spectral power distribution for daylight and for a fluorescent light source respectively. Daylight provides the highest level of color rendering across the spectrum. In fluorescent light source all wavelengths (the full spectrum) are again present but only certain wavelengths (the spikes) are strongly present. The spikes indicate which parts of the color spectrum will be emphasized in the rendering of color for objects illuminated by this light source. It produces a light that is perceived as “warmer” than daylight. Its ability to render color across the spectrum is not bad, but certainly much worse than daylight.

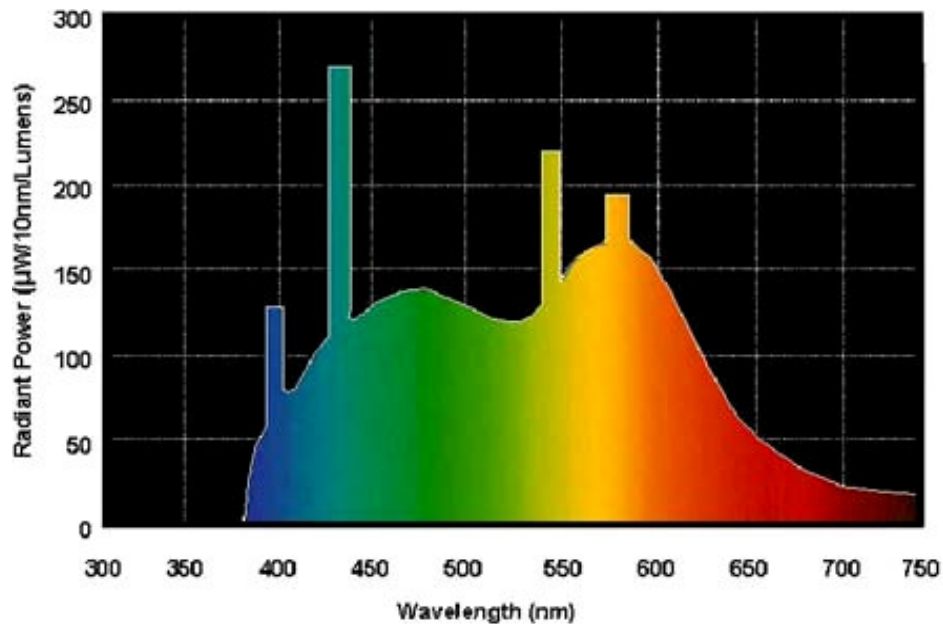

Figure 3.6. Spectral power distribution graph for daylight.
(Source: WEB_6 2006)

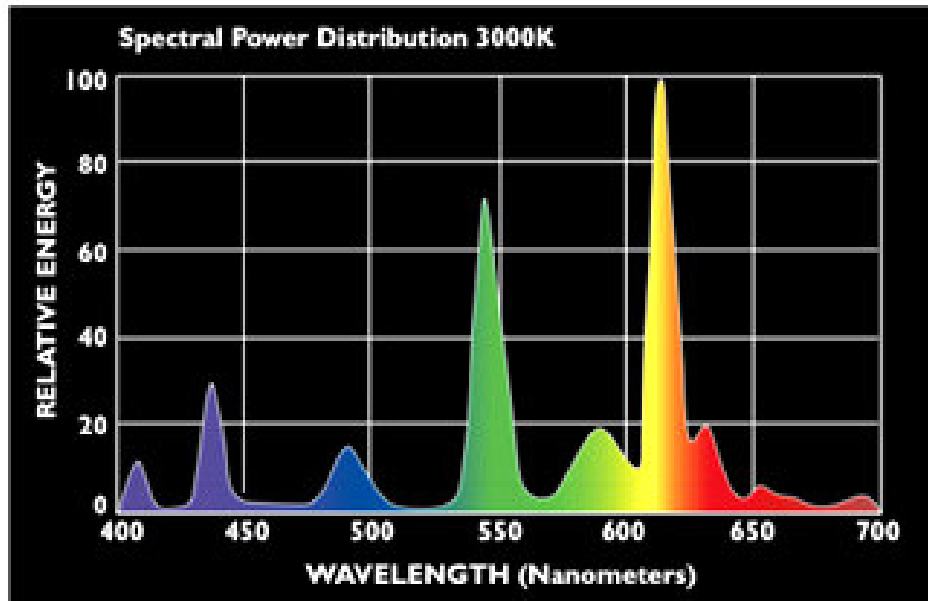

Figure 3.7. Spectral power distribution for a fluorescent lamp.
 (Source: WEB_6 2006)

For reasons of standardization, the light colors of lamps are divided into three groups as daylight white (DW), neutral white (NW), and warm white (WW). Warm white lamps emphasize red and yellow hues, while blue and green are emphasized by daylight white light. The quality of the color rendition, on the other hand, determines whether for example the color of a fabric selected in daylight white fluorescent lighting will look the same in the open air. Color rendition is measured by the Color Rendition Index (CRI). A CRI value above 80 is considered of good quality. Figure 3.8 shows the color temperature of varying lamps. The CRI for each source is shown in the parentheses at the right.

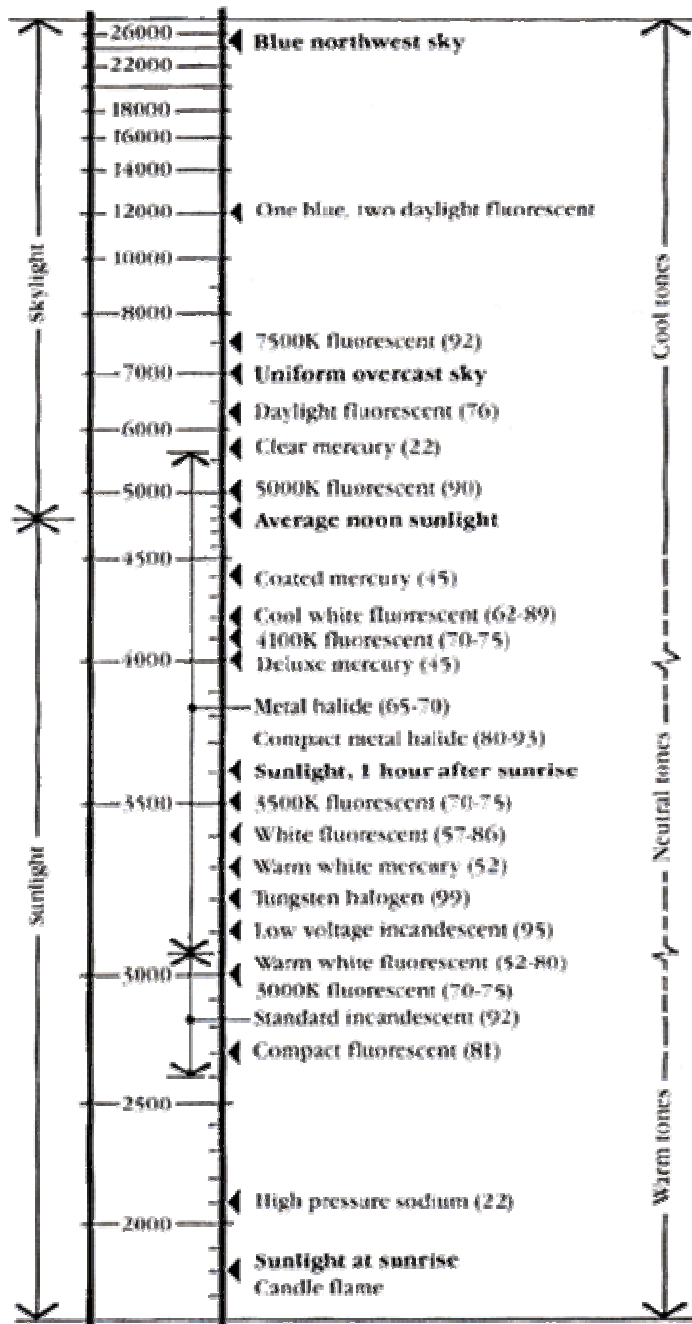

Figure 3.8. Color Temperature of Light Sources.
(Source: WEB_7 2004)

Shaw (1995) states that careful consideration should be made to select the most appropriate light sources available to the designer. He adds that requirements for highly accurate color rendition generally point to tungsten halogen and fluorescent light sources. Others such as high pressure sodium, metal halide, and high intensity discharge (HID), must be preferred where color rendition is not of primary importance.

3.2. Physiological Aspects

In this part the effects of lighting on human physiology are explored. These effects are analyzed in three main titles with varying determinants relevant to light and lighting conditions, as shown in Figure 3.9.

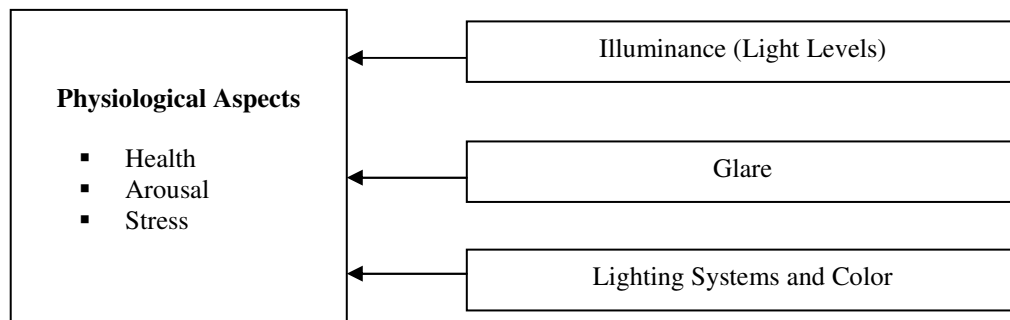

Figure 3.9. Determinants of Physiological Aspects

The physiological effects of light have been well known since ancient times, and have benefited as a tool for treatment of some diseases. Light therapy is still popular today with its important contributions to health after the discovery of the photoreceptor cells in the eye, which clarifies how light mediates and controls some biochemical processes in the human body. According to Bommel and Beld (2003), a new era has been launched by the scientific findings that are related to the control of the biological clock and to the regulation of some important hormones through regular light-dark rhythms.

3.2.1. Health, Arousal and Stress

Arousal is the state of physical and mental activation. Arousal theory, developed by Eysenck (1990) claims that there is an optimal level of arousal, and performance gets worse as one becomes aroused more or less than this optimal level. At very low and very high levels of arousal, performance is low, but at a more optimal mid-level of arousal, performance is maximized.

Stress is the name for a set of physiological and hormonal changes that arise as a response to unpleasant events. These unpleasant events could include environmental conditions such as direct glare, or noise.

Photobiology is a branch of biological science which studies the interactions of light with all living organisms. The reason making photobiology of interest in this research is the knowledge it offers related to the effects other than vision that occur when radiation is absorbed by the photoreceptors in the human eye.

Due to the relationship between what is perceived by the human eye and the nervous system, light is believed to have powerful influence on human biorhythms. Hill (1992) says that light has direct effect on the regulation of circadian rhythms. These rhythms depend on the night and day cycle, the lunar cycle, and the seasonal cycle are strong enough to affect human physiology and capabilities. The importance of lighting and the circadian rhythm can be best shown through the example of shift workers. Today it is a well-known fact that reversed sleep has some negative effects such as fatigue and bad arousal during work. It includes higher risks in a long period of time, such as cardiovascular disease, gastrointestinal ailments and social problems (WEB_8 2004). Shift workers have a mismatch between sleep and work, they work when their body needs sleep. In other words, they do something in night the cycle, which should be done in the day cycle. Researchers showed that bright light exposure could improve arousal and cognitive performance. Light exposure suppresses melatonin secretion (Figure 3.10) and melatonin induces sleep (Boyce et al. 1997). Bommel and Beld (2003: p. 9) discuss the effects of light on hormones as follows:

The hormones cortisol (“stress hormone”) and melatonin (“sleep hormone”) play an important role in controlling alertness and sleep. Cortisol, amongst others, increases blood sugar to give the body energy and enhances the immune system. However, when cortisol levels are too high over a too-long period, the system becomes exhausted and inefficient. Cortisol levels increase in the morning and prepare the body for the coming day’s activity. They remain at a sufficiently high level over the course of the bright day, falling finally to a minimum at midnight. The level of the sleep hormone melatonin drops in the morning, reducing sleepiness. It normally rises again when it becomes dark, permitting healthy sleep (also because cortisol is then at its minimum level). For good health, it is of importance that these rhythms are not disrupted too much. In case of a disruption of the rhythm, bright light in the morning helps restoring the normal rhythm. In a natural setting, light, especially morning light, synchronises the internal body clock to the earth’s 24-hour light-dark rotational cycle. The deharmonisation in the absence of the “normal” light-dark rhythm would result in a wrong rhythm of alertness and sleepiness, ultimately leading to alertness during the dark hours and sleepiness during the bright hours.

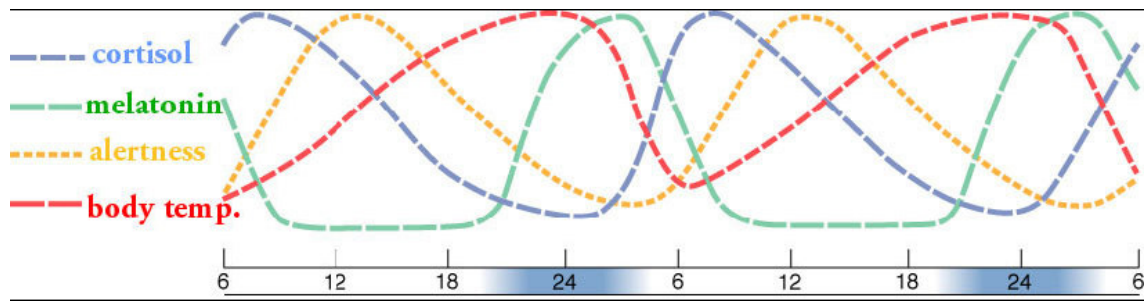

Figure 3.10. Typical daily rhythms of body temperature, melatonin, cortisol, and alertness in humans for a natural 24-hour light/dark cycle. (Source: Bommel and Beld 2003)

Illuminance: When arousal theory is applied to lighting, it may be readily claimed that higher illuminance levels stimulate greater arousal and if the arousal level is appropriate for the task, it results in improved performance. However, if the arousal level is too high, performance would be expected to decline.

Biner (1991) showed that an increase in illuminance from 32 lx to 1743 lx increases general arousal in a workstation. Hughes and McNelis (1978) reported that an increase in illuminance from 500 to 1500 lx caused an average 9 percent increase in the productivity of secretarial office workers doing a difficult paper-based task. Gifford, Hine and Veitch (1997) found that there is no significant difference in task performance between low (average 70 lx) and medium (average 486 lx) illumination levels; however task performance differs 25 percent between low and high (average 1962 lx) illumination levels. Costa (1993) found that night nurses who were exposed to short doses of high light exposure at work showed some signs of better adjustment to the schedule than those without low light exposure. Boyce (1997) found an illumination of 2800 lx triggers more arousal than 250 lx (Figure 3.11). A decline in arousal over the night occurs for both levels, but the high level always results in a significantly increased arousal level and thus better alertness and mood. Another experiment in an office building in Florida showed that circadian lighting helps to keep employees awake and alert (Kelly 2003).

Delay and Richardson (1981) found that individual differences, such as sex, affect the arousal levels in accordance with illumination levels. Increasing illuminance (0,33 lx to 170 lx) has a greater effect on performance in men than women.

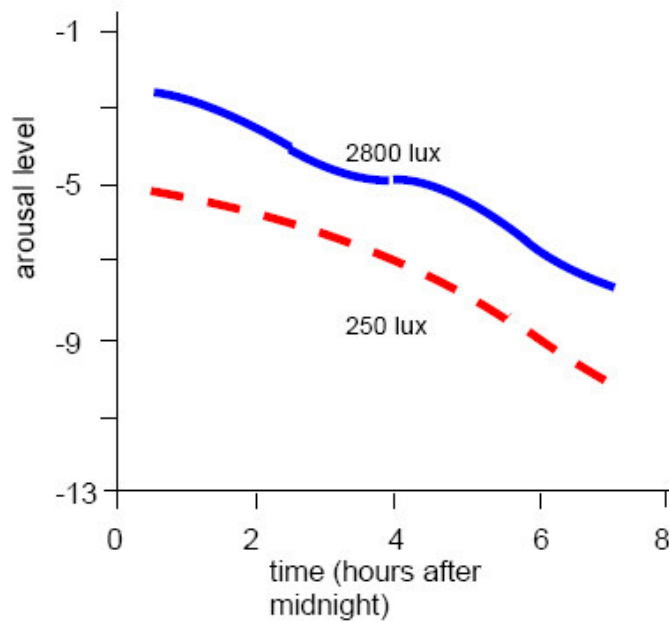

Figure 3.11. Alertness levels according to time passed after midnight.
(Source: Boyce 1997)

Glare: Very high luminances in the field of view or very high non-uniform luminance distributions can cause discomfort. Although the exact mechanism is unknown, today it is widely accepted that glare sources could constitute stressors (Berman et al. 1994). Glare sources can cause headaches (Veitch and Gifford 1996) by forcing the muscles in the eye, making them work harder than usual. Bright lights are more likely to trigger migraine headaches when they are of a “flickering” quality, and a slow flicker is usually more irritating than a more rapid one (WEB_9 2006). On certain places where VDTs are used, special attention must be paid to avoid glare and veiling reflections for physiological comfort.

Lighting Systems and Color: Deriving from their physical characteristics, some lamp types have negative effect on arousal and stress levels, , such as fluorescent light sources. Fluorescent lamps have long been associated with complaints of visual discomfort and headache (Stone, 1992). Known causes of this stress-related effect include flicker rate and spectral power distribution (Wilkins 1993). Wilkins (1990: p. 105) describes flicker as follows:

Some of the commonly-used phosphors that emit long-wavelength light continue to do so for some time after the gas discharge, whereas phosphors with greater emission at shorter wavelengths persist for a shorter time. The longer persisting phosphors introduce a phase lag with the result that the light alternates in color as well as intensity. The degree of flicker depends on the lamp type as well as the ballast type; electronic ballasts reduce chromatic as well as luminous modulation.

Kuller and Laike (1998) found that in fluorescent lighting, using electronic ballasts, which have a frequency of 30 Hz, instead magnetic ballasts of 50 Hz, solves the flicker problem, and thus improves productivity.

It is a well-known fact that color of light itself has an emotional meaning, and is therefore important for the general atmosphere of a space. Today research shows that the spectrum has an important biological meaning, too. Brainard (2002) claims that the sensitivity of the novel photoreceptor cell in the eye varies in terms of melatonin suppression for different wavelengths of light, thus for different colors of light.

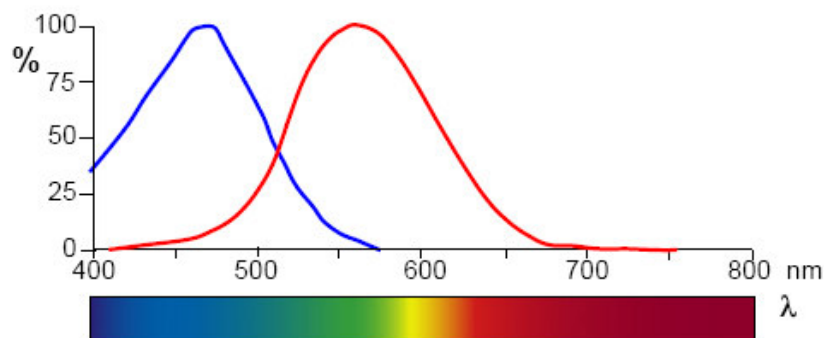

Figure 3.12. Spectral biological action curve (based on melatonin suppression), in blue, and the visual eye sensitivity curve, in red. (Source: Brainard 2002)

As shown in Figure 3.12 the bluish, cool light has biologically larger effect than red colored warmer light. The bluish morning light for example has biologically an activating (alerting) effect, while the red sky in the early evening has a relaxing effect. In an architectural environment, both activating and relaxing impressions are required. The color and level of the artificial lighting together may help to create these impressions.

3.3. Psychological Aspects

This part focuses on the psychological effects of lighting. These effects are analyzed in three main titles with varying determinants relevant to light and lighting conditions as shown in Figure 3.13.

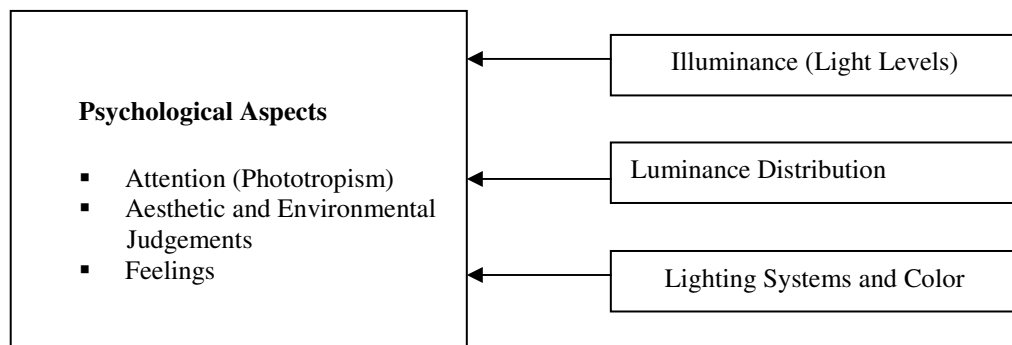

Figure 3.13. Determinants of Psychological Aspects

According to Wagner (1985), the quality of luminous environment can influence both comfort and well-being, which are psychological in nature and also behavioral. Boyce (1981) proposed that lighting quality exists when the luminous conditions support the behavioral needs of an individual in space. This definition could easily be expanded to include architectural considerations and individual well-being. The quality of the lighting in any installation is determined in the balance of these dimensions.

The aim of this part is to bring the scientific evidence to light concerning the psychological mechanisms that produce behavioral effects in response to luminous conditions. The goal is to describe the knowledge about these effects which are considered as an important dimension in explaining lighting quality. This part is organized under three main parts which are believed to underline the relationship between lighting and behaviors: Attention, Environmental Judgments, and Feeling and Preferences. This set may be expanded, but they together constitute a principal in approach to lighting. They are chosen because of the frequency of their use in explanations of lighting design choices. When one understands why certain luminous conditions produce certain behavioral outcomes, then one will be able to re-create those conditions and those outcomes.

3.3.1. Attention

According to Lam (1992), attention and the feeling of orientation is a need for human beings. Continuous visual information is required for all physical activities, such as walking, running, and working. In a space one searches for clues that give orientation for experiencing the inner atmosphere. When these clues are absent or distorted, the effect can be very disturbing.

Illuminance, Luminance Distribution: The main theory -which is widely accepted and rather beneficial- is that the light output could be increased to direct the viewer's attention to particular elements in the environment. For example, theatrical lighting design uses spotlights to direct the audience's attention to the important characters on stage. The aim is to make a target obvious by contrast against the background. Luminance distributions are used to generate attention response. In general high-brightness lighting that produces sharp contrasts and sharply defined outlines is more powerful than softly graded lighting.

Hopkinson and Longmore (1959) reported that attention on a vertical visual task was best when the task was locally lit, than when it was lit from general illumination alone. A small light source in high-brightness below the task attracted more glances, whereas a larger, low-brightness source appeared to be less attractive. Another research showed the increase in performance related to attention. Taylor et al. (1975) reported that adults were more successful in arithmetic calculations under non-uniform lighting with incandescent desk lamps (the task became the point of attention), than when the office was lit with uniform fluorescent lighting.

The effect which is called "human phototropism" also encourages movement. It is a widely accepted fact and one of the important effects of light benefited from in the creation of spatial organizations, although there is only one study to support this assertion, which is completed by Taylor and Sucov (1974). In their study they reached two conclusions: (1) For equivalent hallways 67% of the people will go to the right. (2) People tend to choose the brighter path.

3.3.2. Aesthetic and Environmental Judgments

Aesthetic judgments concern the interpretation and categorization of what we see; they are not only emotional reactions. The first task is to determine the dimensions through which we make aesthetic judgments, and the second is to determine how our aesthetic judgments relate to other responses such as feelings and preferences. Behavioral sciences developed some tools and methodologies to measure aesthetic judgments, such as Semantic Differential Rating Scales, Factor Analysis, Multidimensional Scaling, and various observation and mapping methods. Nowadays it is also possible to apply these methodologies on computer simulations.

Flynn (et al. 1992) argues that visual consciousness did not seem to be completely explainable with simple notion of an optical image imposed on the retina of the eye and photographically interpreted by the brain. Instead, he says, one finds indications that there is considerable selectivity in the process of visual experience- a search for meaningful information. He suggests that light could be discussed as a vehicle that facilitates the selective process and alters the information in the visual field. He further suggests that lighting design should be evaluated in part for its role in adequately establishing clues that facilitate or alter the user's understanding of his environment and activities around him.

In lighting design the work should convey a meaning. As in every kind of design, the end-product should neither lack something necessary nor include something unnecessary. As Waldram (1954) said, lighting designers must be warned against "doodling with light" . By saying this he was referring to the meaningless use of spotlighting outside of the architectural context.

Kaplan (1987) claimed that as humans need to make sense of what they see and to become involved in it. In his information-processing model he suggested four dimensions of appraisal, which are coherence, legibility, mystery, and complexity. The first two relate to the presence of information, and the latter two concern the need to be an active interpreter of the information.

Illuminance, Luminance Distribution and Lighting Systems: The first and most influential work in this subject is Flynn's work in 1973, where he applied sophisticated psychological techniques to lighting research. His aim was to find out how

lighting affects user impressions. He obtained ratings on 34 semantic differential scales in response to six lighting configurations. A factor analysis grouped the scales into five categories, which are evaluative, perceptual clarity, spatial complexity, spaciousness, and formality. Conclusions were that an overhead diffusing light system may affect the impression of perceptual clarity but this has little effect on evaluative impressions such as pleasantness or friendliness. Overhead downlighting tends to give more positive evaluative impressions than overhead diffuse. Also the downlighting tends towards a more spacious impression.

His conclusions have been included in IESNA Lighting Handbook (1981) with little modification. For example, relaxation is said to be supported by non-uniformity, particularly non-uniform wall lighting. Perceptual clarity is said to be supported by higher horizontal illuminance in a central location. Spaciousness is said to be supported by uniform lighting and bright walls.

Judgments that a space appears interesting or pleasant are associated with non-uniform luminance distributions in the field of view. VDT operators preferred having a spot light to highlight a painting on the wall beyond the VDT screen, over the same wall with uniform illumination (Yearout and Konz 1989).

Inui and Miyata (1973) reported that the sense of spaciousness increases with an increase in horizontal illumination (from 50 lx to 750 lx). He used a scale model, where the walls could be moved and the size of the windows could be adjusted. An artificial sky was used with a set of variable luminaries.

Stone et al. (1980) tried to decipher variability according to illuminance differences. Subjects were asked to evaluate seven lecture theaters. Each person used a 15 point scale to judge the space as “totally similar” or “totally dissimilar”, comparing the quality of light in the current lecture theater to the once previously viewed. Three principles of dimensions of variability are as follows: 90% of the variance is accounted for the illuminance at the position of the lecturers head. 49% is accounted for the horizontal illuminance at the eye level of the sitting subjects.

Manav and Yener (1998) found that wall washing enhanced the impression of clarity and order, cove lighting enhanced spaciousness, and uplighting made the same space relaxing, private and pleasant. In Fleischer et al. s (2001) work, subjects rated their work environment as more pleasing and cheerful at higher levels of illuminance. In the research indirect lighting was preferred more than direct lighting, even with daylight colored lamps.

Color: Psychological research on color has been primarily directed at color in pigment, with limited attention to the effect of colored light. According to Fleischer et al. s (2001) work, warm white colored lighting installations are more pleasing than daylight colored lighting installations. Benya (1988) mentioned that blue-poor light sources impair focusing (because the eye mostly relies upon signals from the retina's cone cells in response to blue wavelengths) and make objects seem blurry. Low color temperature environments therefore appear soft-edged and unclear, while high color temperature environments appear cold and sharp. He also recommends a list for lighting designers, who wants to affect the mood in space through the use of colored light:

- Higher color temperatures are more tense and active; lower color temperatures are more relaxed and slow.
- To stimulate a feeling of warmth and coziness use lower color temperature sources.
- For a feeling of coolness or sharpness, use higher color temperature sources.
- To stimulate a feeling of uneasiness, use a poor CRI source. Sodium sources, for example, will appear stark and alarming.

3.3.3. Feelings and Preferences

People experience particular feelings or moods in all environments. Architects, designers and critics have always used the language of feeling to describe spaces. Rooms have been called “dreamlike” , “cold” , “tense” , “warm” , “cozy” , and been described in other subjective ways. These moods are the general result of humans' psychological response to architecture and undoubtedly light plays a great role in shaping them when it interacts with space.

Aesthetic judgments concern the appearance of space. Preferences include an emotional character and give answers to how the space makes the viewer feel. Today it is a well-known fact that environmental conditions that create a state of positive emotional response lead to better performance, greater effort and greater willingness to help others (Baron 1994).

This shortly framed theme has an intuitive character. In order to handle this knowledge, empirical demonstrations are needed. The first task is to find out which

luminous conditions are preferred, and the second task is to check whether these preferred conditions lead to desired behavioral outcomes.

Illuminance: Preferences for illuminance levels are generally higher than the recommended levels, although preferences vary widely between individuals, settings, and tasks. Nelson et al. (1983) found that an increasing illuminance level from 100 to 320 lx, which was still lower than the male participants' preferred level for office work, decreased men's ratings on mood measures (concentration, activation), but increased women's scores on these measures.

Tregenza et al. (1974) stated that visual difficulty of the task, age of the subject and characteristics of the surfaces illuminated were the factors that effect illuminance selection. Begemann et al. (1995) reported that two male participants whose illuminance preferences were observed over a year showed difference in the preferred level, one with a very low level and one with a high level. Leslie and Hartleb (1990) found that female subjects prefer lower illumination levels than male subjects.

Boyce et al. (2001) concluded that the illuminance provided by a lighting installation is the major factor in determining whether that lighting installation will be liked or not. Kimmel and Blasdel (1973) found that student ratings of library lighting installations showed a preference of 425 lx, which was lower than they expected. Horst et al. (1988) found that ratings of the ease of working, desire to work under the lighting condition, and comfort, increased from 10 to 200 lx illuminance, and then remained stable. Increasing illuminance for these control room tasks from 200 up to 800 lx did not alter these subjective ratings.

Looking at the scientific results above, it is clear that there is an enormous individual variety in illuminance preferences.

Luminance Distribution: It is clear from many studies that vertical surfaces are key to satisfaction. People prefer brighter walls to dark ones. Rowlands et al. (1985) indicated that there was strong correlation between subjective ratings of satisfaction and the lighting on the work plane, the lighting on the walls, and the average luminance of the whole view. Non-uniform distributions from task/ambient combinations can contribute to the creation of environments that one would describe as comfortable, particularly for VDT work (Inui et al. 1989).

Collins (1990) found that work station brightness was a stronger determinant in comparison to task illuminance when determining satisfaction. Evaluation of subjective response to the brightness of the work station was obtained through the use of a seven point semantic scale of bright to dim. Results showed that occupants made their judgments on room luminance rather than illuminance. Subjects preferred direct furniture-mounted fluorescent luminaries, which causes high brightness and low task illuminance, rather than indirect furniture-mounted fluorescent luminaries, which causes a more uniform atmosphere with low brightness and high task illuminance.

Collins et al. (1990) concluded that the low ratings given by office occupants to the combination of indirect furniture-mounted fluorescent luminaries with undershelf task lamps was related to the high task illuminance and low peripheral brightness of the workstation. When the same systems furniture was lit with a direct system, vertical luminances were higher and so was satisfaction.

Kinkeldey et al. (1990) stated that brightness differences were the most important aspect for the user in assessing the lighting quality. His study concluded in a recommendation of more brightness than 1:10 between the working place and the room itself. Loe et al. (1991) found that people preferred to have some non-uniformity of brightness patterns, with a ratio of not less than 15. The general value for the preferred subjective brightness is 100 cd/m².

Ooyen et al. (1986) studied preferences for various luminance distributions at a fixed task illuminance of 750 lx by varying the reflectance of room surfaces. They concluded that wall luminance is the principal contributor to the experience of the room. An increase in wall luminance will make the room feel more stimulating and make concentrating on the task easier. Another conclusion was that as the wall luminance increases, a lower desktop illuminance is preferred.

Mc Kennan and Parry (1984) found that non-uniform distributions were more acceptable. All the installations both localized (directed from the ceiling to the desk) and local (task lamps) lighting were rated satisfactory, even when they were lower than the recommended levels.

Hawkes et al. (1979) found that 8 configurations with diffuse light sources were all rated as uninteresting; 10 configurations with one or more focused source were rated as interesting. Loe (et al. 1982) determined that non-uniform wall lighting was preferred for viewing paintings in a gallery.

Lighting Systems and Color: Hawkes et al. (1979) found that the least preferred lighting scheme in offices is one with regular receding luminaries. Kaneko and Tagahashi (1973) stated that recessed fluorescent luminaries with clear prismatic panels or with plastic louver were not preferable because of their tendency to make the interior gloomy.

Flynn (1977) found that wall lighting added to overhead downlighting were preferable over peripheral overhead lighting in all his three categories of impression, which are evaluative, visual clarity, and spaciousness. Overhead downlighting alone produce a better impression of visual clarity than peripheral systems.

Hedge et al. (1995) managed a study of suspended lensed-indirect and parabolic louvered lighting systems. The results showed that office workers preferred the lensed-indirect systems.

Evans (2000) stated that the functional use of color is designed around the use of a variety of colors in order to keep human responses continually active and to avoid severe visual adaptation or emotional monotony.

Knez (1997) reported that there is a slight difference in color preferences between men and women. In his study he used two lighting system with varying CRI and illuminance. According to the positive mood results, for females the most optimal lighting combination in preserving that mood over a period of 80 minutes of intellectual work was the 300 lx at CRI 95 lighting. For males, on the other hand, the 300 lx by CRI 55 and 1500 lx by CRI 95 lightings accounted for a similar effect.

Tulmann (2000) searched the effects of colored light on consumers' preferences. In his experiment he used two storefront displays in a shopping mall, one with general ambient lighting closer to the daylight spectrum, one with dynamic full-spectrum digital lighting. The colored storefront display has received attention 40 percent more than the one with white light and the traffic in the store increased 20.7 percent relatively to the same time period a year earlier.

Knez (1995) found that warm (more reddish) lighting has a positive effect on mood, while cool lighting (more bluish) has a negative effect on mood in younger participants. In older participants the reverse effect was observed. This implies that coloring quality of indoor lighting has different emotional meanings for younger and older people.

In the light of this detailed knowledge, an evaluation methodology is designed to assess lighting quality. As seen in Figure 3.14 each of three aspects work as a plug,

which make the evaluation methodology flexible for varying architectural functions. It is possible to remove or add new aspects or criteria according to the relevant function. It is important to make a pre-evaluation study where the lighting needs were discussed concerning architectural function.

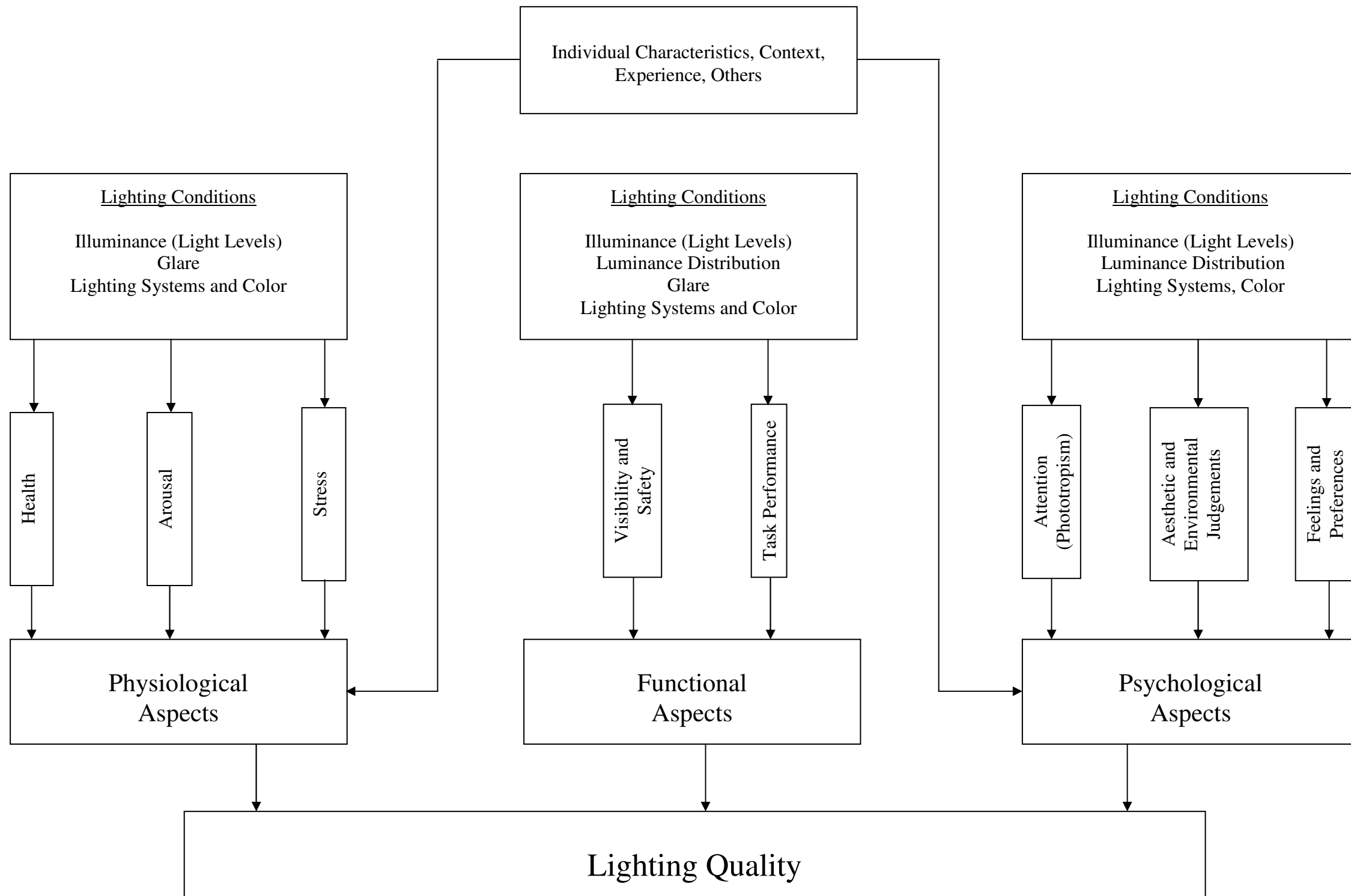

Figure 3. 14. Diagram of the Evaluation Methodology for Artificial Lighting Quality

CHAPTER 4

CASE STUDY

It is necessary to make a research concerning the architectural function of the case prior to evaluation because each function has its own unique lighting requirements as mentioned before. Due to the special requirements of the function, the proposed evaluation methodology may change through addition or removal of certain criteria. Following part will focus on detailed lighting requirements of museums and art galleries in terms of artificial lighting, since the case of this dissertation is a permanent gallery for educational purposes.

4.1. The Requirements of Museums and Art Galleries in Terms of Artificial Lighting

In the history of lighting, museums and art galleries have been the forerunners of advanced solutions. Museum architecture developed during the nineteenth century. Since then architecture and art have changed a lot, but the basic lighting problem has remained the same, perhaps having become even more severe than before because of the wide use of glass surfaces. Since this dissertation focuses only on electric lighting natural lighting and its effects on various objects will not be discussed.

Museum and art galleries are areas in which objects of art (with historical value, or for educational purposes) are displayed to the public. They vary in size, shape, and texture, also in the manner or position in which they can be shown best. In the nineteenth century gas lighting was used (Figure 4.1) to illuminate those pieces of art, which had severe disadvantages both in quality and quantity. Today the vast industry of illumination provides lots of possibilities in lighting if it is used carefully. Lighting requirements of museums and art galleries could simply be divided into two subgroups, such as:

- Quantitative requirements
- Qualitative requirements

4.1.1. Quantitative Requirements

Lighting in museums and galleries has a double-sided character, which requires solutions for opposing requirements. Art Objects in museums and galleries must be preserved and, at the same time, be available for display. Pigments tend to deteriorate with illumination, but illumination is necessary to see the art works (Scuello et al. 2003). Although we could not do without light in museums and art galleries, it is important to remember that light is an environmental factor that contributes to the deterioration of our valued collections (Figure 4.2). All common light sources, such as the sun, light bulbs and fluorescent tubes, also give out other forms of radiation to varying degrees. The most significant of these are ultraviolet⁸ and infrared⁹ radiation. Ultraviolet radiation is potentially the most damaging form of energy present in museums, and art galleries. So when lighting an area where important or valuable works are housed, it is essential to take precautions to minimize the potential damage.

Although light is not fully responsible for most of the damage, there is a clear relationship between exposure to light and the amount of deterioration in museum collections. Deterioration caused by light can be divided into two main types: thermal and photochemical.¹⁰ While thermal effects are attributed to the infrared content of the

8 Ultraviolet (UV) light is electromagnetic radiation with a wavelength shorter than that of visible light, but longer than soft X-rays. The name means "beyond violet" (from Latin *ultra*, "beyond"), violet being the color of the shortest wavelengths of visible light. Some of the UV wavelengths are colloquially called black light, as it is invisible to the human eye (WEB_10 2006).

9 Infrared (IR) radiation is electromagnetic radiation of a wavelength longer than that of visible light, but shorter than that of radio waves. The name means "below red" (from the Latin *infra*, "below"), red being the color of visible light of longest wavelength. Infrared radiation spans three orders of magnitude and has wavelengths between approximately 750 nm and 1 mm (Wikipedia 2005). Infrared radiation is less energetic than ultraviolet radiation and visible light. It heats materials and can cause them to expand, leading to mechanical stresses; and can also cause chemical changes to progress more rapidly. As a result, infrared radiation can increase the destructive effects of visible light and ultraviolet radiation. Once started, photochemical reactions can continue even after the exposure to light or ultraviolet radiation has stopped. This means the deterioration of objects does not stop when the objects are placed in the dark (Heritage Collection Council 1998).

10 When light and ultraviolet radiation fall on an object, they deliver bundles of energy to that object. As a result, various chemical reactions can take place, depending on the amount of energy delivered. These reactions are called photochemical reactions. In some cases it is very easy to see the effects of these reactions: try leaving a piece of newsprint in the sun for a few hours and examine the results. The paper becomes discolored—yellowed. However, most changes caused by photochemical reactions are not as quick as this nor as obvious; so it is difficult to know they are occurring. Nevertheless their effects can be devastating and ongoing by causing extreme and irreversible damage to many materials, most notably organic materials that derive from plants and animals. In a museum, gallery or library, these will include furniture, textiles, prints, books, drawings, manuscripts, wallpaper, dyes and inks, feathers and fur. (Gabosh 1994)

light source, photochemical effects are attributed to the ultraviolet content of the light. Local heating caused by this infrared radiation results in a change in relative humidity in the immediate region of the illuminated object, which can cause movement, warping and splitting in moisture-absorbing materials such as wood and some types of glass (CIBSE 1994). More important is the photochemical damage, which causes color change and physical deterioration.¹¹



Figure 4.1. Detail of a gas pipe, showing the burners on both sides.
(Source: Swinney 1999)

¹¹ Pavlogeorgatos G. (2003) points out the deterioration process related to lighting as follows: It is well known that the deterioration process of materials requires energy. Light is the most powerful source of energy in museums. Thus, (natural and artificial) illumination in museums can:

- accelerate the deterioration and corruption of several materials, because it acts as a catalyst to their oxidization;
- subsidize and raise the fragility level of cellulose fibres (wood, paper);
- discolor, fade or blacken the paper;
- fading and/or alter the dye/painting colors and materials of works of art;
- corrode significantly every natural fabric;
- deteriorate exhibits in Natural History Museums; and
- increase the surface temperature of exhibits.



Figure 4.2. The pigments on the edge of this watercolor have not faded because they have been protected by the mount. (Source: Heritage Collection Council 1998)

Some objects are insensitive to light while others are so easily damaged that a very short exposure will produce a change in appearance. This sensitivity depends on the chemical composition. As a general rule, inorganic materials such as glass, ceramic, stone, and metals are less sensitive to photochemical deterioration than organic materials such as dyes, pigments, textile, wood, and paper. Photochemical change is irreversible. Thus lighting must be considered a high priority issue in museums and art galleries.

In selecting light sources it is vital to know that visible light is often accompanied by these ultraviolet and infrared radiations. There are many types of artificial light sources. Each has advantages and disadvantages. Incandescent lamps, in spot or floodlights, have a low ultraviolet output, but emit infrared radiation in the form of heat. Therefore, if they are close to items or placed in a closed case, they can cause damage by raising the temperature of the objects because of the high intensity. If we want to lower the intensity of light falling on an object we can simply move it further away from the light source. For example, if the brightness or intensity of light falling on an object is measured at 100 lx when the object is one meter away from the light source, we can decrease that intensity to 25 lx by moving the object to a distance of two meters from the light source.

Fluorescent light tubes are cold, but many emit higher than acceptable levels of ultraviolet radiation (Heritage Collection Council 1998). However, fluorescent tubes are generally preferred, because they are more effective in cost and are longer-lasting than incandescent bulbs. If fluorescent or halogen lights are used, low ultraviolet-emitting fluorescent tubes should be preferred, and/or some sort of ultraviolet-absorbing filter should be used to remove the ultraviolet radiation. This filter can be used on the lamps or on display cases and frames. They are available in forms of films, acrylic sheets, and lacquers

Tungsten metal halide bulbs, which are more efficient than ordinary incandescent bulbs, also give out higher than acceptable levels of ultraviolet. So they need to be filtered in order to avoid any potential damage.

Illumination standards in museums and galleries have been established to control the amount of damage caused by light. While all wavelengths of light can cause some damage, the shorter wavelengths are more damaging (Scuella et al. 2003).

Illuminance ratios in museums are becoming lower as a tendency in the world, since high illumination means more problems in the way of preservation. There are varying standards of illuminance for museums and art galleries, formed by varying authorities in the world, such as the IES (Illuminating Engineering Society), JIS (Japan Illumination Standards), and ICOM (International Council of Museums). These standards considering varying materials are indicated in Table 4.1, Table 4.2, Table 4.3, Table 4.4.

As seen in the tables, for sensitive materials such as textiles and watercolors the brightness of the light should not be greater than 50 lx and the exposure in one year should not be greater than 150 kilolux-hours. In addition to this the ultraviolet content of the light should not be greater than $75 \mu\text{W}/\text{lm}^{12}$, and preferably $30 \mu\text{W}/\text{lm}$ (CIBSE 1994). For moderately sensitive materials such as oil paintings and furniture the brightness of light should be between 75-200 lx and the exposure in one year should be between 180-600 kilolux hours.

¹² $\mu\text{W}/\text{lm}$ (Microwatts per lumen) is the unit which indicates the amount of UV energy in the light coming from a light source. Microwatts are a measure of energy; lumens measure the quantity of light from a particular light source. This measurement is constant for a light source and does not alter if the readings are taken at a greater distance from the source. If one needs to lower the UV content of the light, one can use absorbing filters on light sources, or can install lights that give out only small amounts of UV radiation. (Light and Ultraviolet Radiation 2005)

Table 4.1. Maximum Illuminance Recommended (lx)
 (Source: International Lighting Review 1977)

Object	ICOM	IES
Metal Stone Glass and ceramics Stained glass Jewellery Enamel	not restricted but rarely necessary to exceed 300 (colour temperature 4000-6500K)	unlimited but subject to display and radiant heat considerations in practice
Oil and tempera painting Natural leather Horn Bone Ivory Wood and lacquer	150-180 in service (Color-temperature ca. 4000K)	150
Textiles, Costumes Water colors Tapestries Prints and Drawings Stamps Manuscripts Miniatures Gouaches Dyed leather	50 (less if possible) (Color temperature ca. 2900K)	50

Table 4.2. Recommended Illuminance and Illuminance-Hours per Year
(Source: IESNA 1987)

Item			Illuminance (lx)	Total exposure limits per year (lx-hour) ¹³ (lx x hr x day)
Displays of non-sensitive materials			200-300-500	No limit
Displays of sensitive materials	High susceptible displayer materials	Silk Art on paper, Antique documents, Lace Fugitive dyes	50	120,000 (50 x 8 x 300)
	Moderately susceptible displayer materials	Oil Paintings Cotton Wool Other textiles where the dye is stable Certain wood finishes Leather	75	180,000 (75 x 8 x 300)
Lobby, general gallery areas, corridors			100-150-200	No limit
Restoration or conservation shop and laboratories			500-750-1000	No limit

¹³ Lux-hour is the unit which indicates the exposure to light over a period of time. Take the example of an historical costume on permanent display in a museum. The museum is open 5 days a week for 5 hours a day all year round and while the museum is open, the costume receives light to an intensity of 200 lx. In a year -the costume is exposed to: 5 x 5 x 52 x 200 lux-hours = 260000 lux-hours or 260 kilolux-hours. This could be brought to within the levels recommended in the guidelines by adjusting the intensity of light falling on the costume and/or reducing the display time. For example, if the intensity of light was lowered to 50 lx and the costume was on display for only 6 months of the year, the total annual exposure would be significantly altered: 5 x 5 x 26 x 50 lux-hours = 32500 lux-hours or 32.5 kilolux-hours (Heritage Collection Council 1998)

Table 4.3. JIS Illuminance Standards
(Source: WEB_11 2003)

Illuminance (lx)	Museum
750-1000-1500	Sculpture (stone, metal) Molding object Model
300-500-750	Sculpture (plaster, tree, paper) Oil painting Laboratory Investigation room Stand Entrance hall
150-250-300	Pictures (with glass) Japanese painting Rest room Small meeting room Classroom
75-100-150	Gallery Dining room Tea room Passage Stairs
30-50-75	Receipt warehouse

Table 4.4. CIE Illuminance Standards
(Source: WEB_5, 2003)

Material Classification	Examples of materials	Limiting illuminance	Limiting annual exposure
Insensitive	metal, stone, glass, ceramic	no limit	no limit
Low sensitivity	canvases, frescoes, wood, leather	200 lx	600 000 lxh/a
Medium sensitivity	watercolor, pastel, various papers	50 lx	150 000 lxh/a
High sensitivity	silk, newspaper, sensitive pigments	50 lx	15 000 lxh/a

In museums and art galleries there are three ways for materials to be put on view depending on their type, nature and size:

- Hanging on a wall or a surface within the exhibition (Oil paintings, watercolors, print-outs, etc.)
- Putting in a display case (jewelry, ceramics, pottery, glass, textiles, etc.)
- Leaving as free-standing objects (Sculptures, furniture, skeletons, etc.)

All these materials give different responses to light. Thus each of them needs to be illuminated according to different techniques concerning conservation and also visibility. Major considerations will be the maximum amount of light permitted, the ultraviolet content of light, and the placement of light sources.

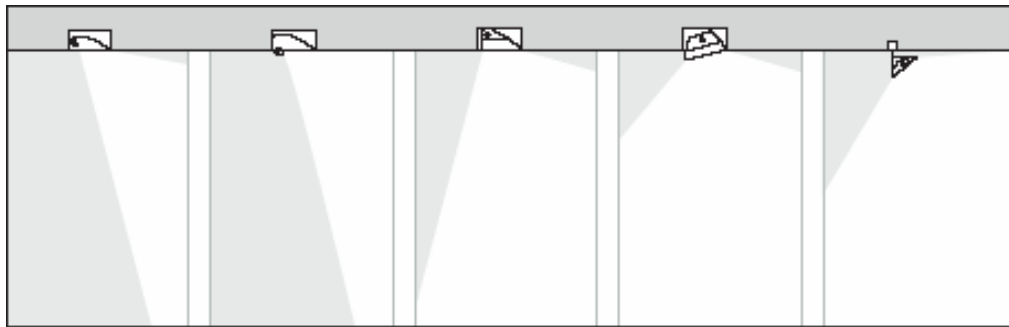

Figure 4.3. Wall lighting using linear luminaires
(Source: Ganslandt and Hoffmann 1992)

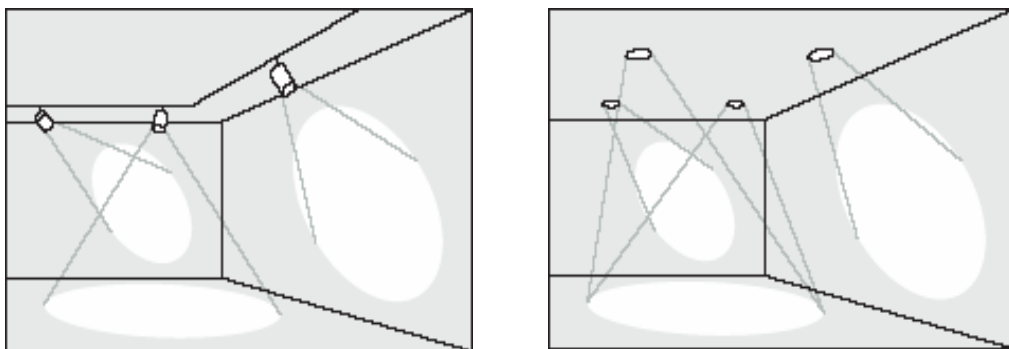

Figure 4.4. Individual Lighting
(Source: Ganslandt and Hoffmann 1992)

There are two possible approaches to lighting for materials hung on surfaces. One is to light the display wall with a relatively even distribution of light, which will be usually provided by a linear system of lighting (Figure 4.3). The second approach is to highlight each painting or a group of paintings (Figure 4.4). First approach is

particularly used for large paintings and wall paintings. If the second approach is preferred, it is necessary to aim the spotlighting from such a position that reflected images of the lamp do not occur in directions of view and cause glare. When illuminating paintings using spotlights, the luminaries should be arranged so that the angle of incidence of the light is approximately 30° (Figure 4.5), the so-called “museum angle.” This produces maximum vertical lighting and avoids reflected glare that may disturb the observer (Ganslandt and Hoffmann 1992). This angle handles reflected glare, illuminance and frame shadows optimally. Figure 4.6 shows the different lighting solutions considering glare.

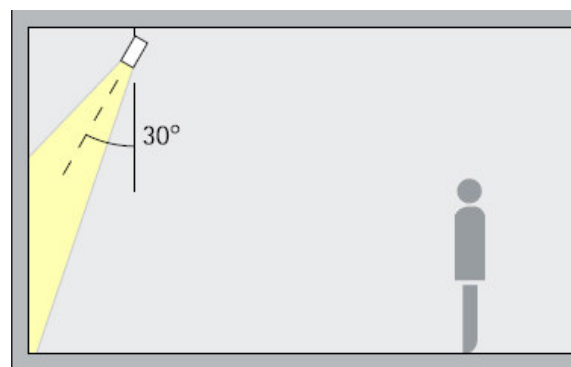

Figure 4.5. The optimum angle of incidence for the illumination of paintings is 30° .
(Source: Ganslandt and Hoffmann 1992)

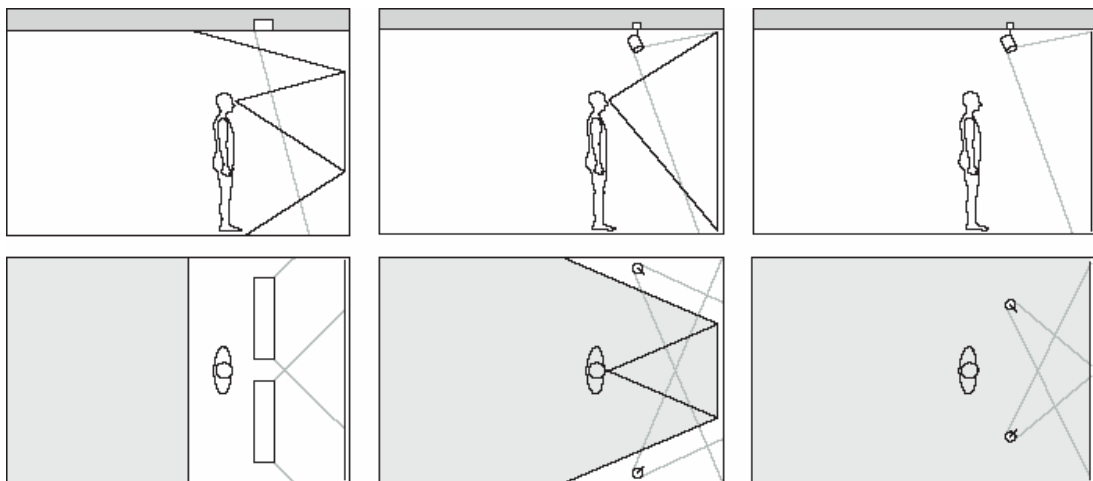

Figure 4.6. Lighting solutions for vertical visual tasks free of reflected glare (from left to right): if the reflective surface is arranged transversely, the luminaires can be mounted in front of the excluded ceiling zone. If the reflective surface is arranged vertically, then next to the excluded ceiling zone (centre). If the entire wall surface is reflective, the luminaires must be mounted within the excluded zone; the cut-off angles must be planned such that the observer is not disturbed by reflected light. (Source: Ganslandt and Hoffmann 1992)

In many museums, especially those where archaeological, ethnological or scientific information is presented, the exhibits are primarily displayed in showcases. This is for protecting exhibits from possible damage by visitors and bad environmental conditions while providing increased security. When developing the lighting design concept, priority must be given to the showcases. The first task of the lighting is to illuminate the exhibits in accordance with their particular qualities. It is possible to illuminate the showcases both internally (Figure 4.7) and externally (Figure 4.8).

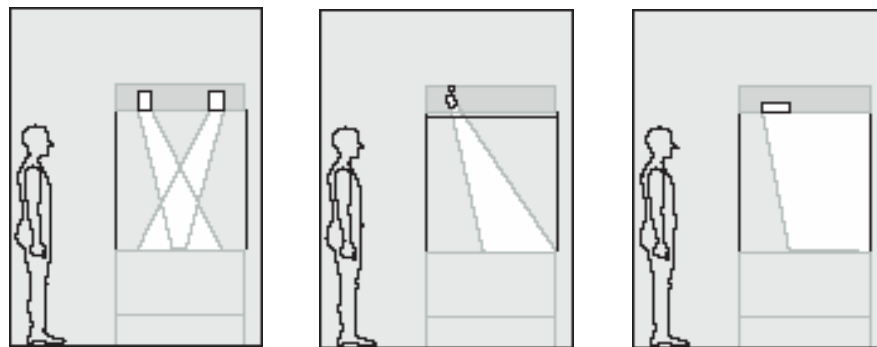

Figure 4.7. Internal illumination for showcases. Left: Accent lighting inside the showcase is provided by recessed low-voltage directional spotlights. The luminaires are equipped with covered reflector lamps to avoid danger to the exhibits. Middle: Showcase lighting using spotlights. The showcase is shielded by a filter attachment and an anti-dazzle screen. The upper section of the showcase can be ventilated separately. Right: Wide-beam lighting of the showcase using a washlight for compact fluorescent lamps or halogen lamps. (Source: Ganslandt and Hoffmann 1992)

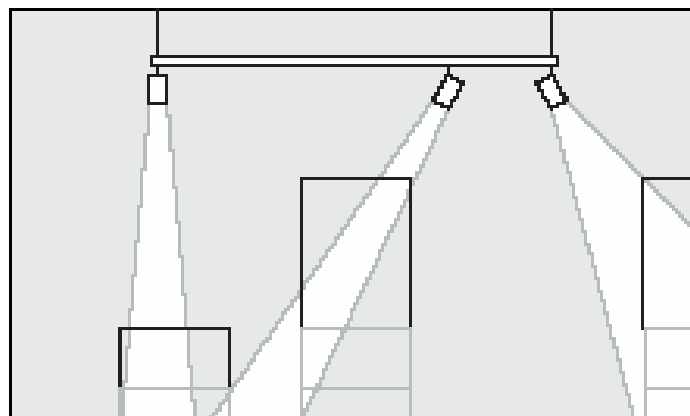

Figure 4.8. External illumination of showcases. Spotlights are mounted on a suspended light structure. (Source: Ganslandt and Hoffmann 1992)

Depending on the type of materials that are to be illuminated, choice of lamp, filtering and illuminance control must be investigated carefully for not to damage the exhibit. The damage caused by visible light, ultraviolet and infrared radiation,

overheating in showcases due to convection is also an aspect to be considered. In the case of sensitive exhibits it may be necessary to install integral luminaries in a separate compartment of the showcase. The lighting equipment should ideally be isolated from the display area of the case in a compartment with separate access so that the lighting can be maintained and lamps replaced without disturbing the exhibits (CIBSE 1994).

When lighting showcases it is especially important to avoid reflected glare on horizontal and vertical glass surfaces. Careful attention must be paid to the positioning and direction of luminaries when illuminating the showcase from the outside. One of the most difficult problems to overcome is the unwanted light reflections on the external surface of the showcases. These can cause irritation, distraction, and in some cases obliterate the view of the exhibit. The main reason is the electric lighting equipment mounted in the “forbidden zones” (Figure 4.9).

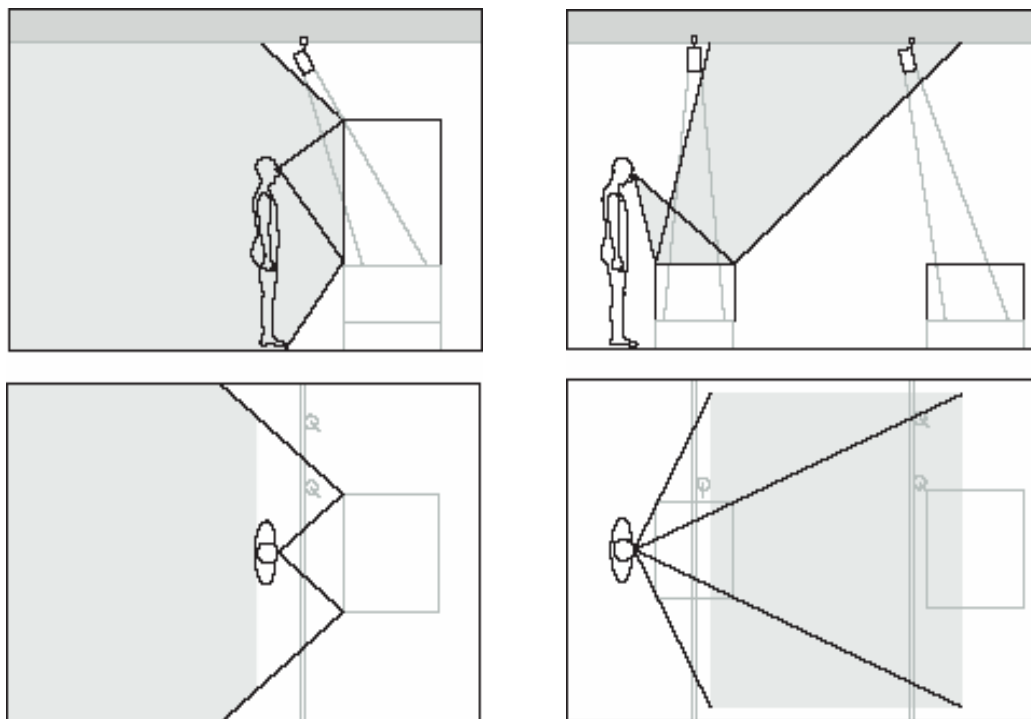

Figure 4.9. Identifying the “forbidden zones” for horizontal reflecting surfaces. No lamp luminances should be reproduced on the reflecting surfaces from these areas of the ceiling. It is acceptable to position luminaries in these areas, provided they are directed or shielded so as not to produce glare effects. (Source: Ganslandt and Hoffmann 1992)

Transparent materials, such as glassware, can be illuminated by a system integrated into the base of the showcase. Generally halogen and fluorescent lamps are used. Fiber optic systems can also be considered if thermal load due to lamps inside the cases are high, or if the showcase dimensions do not allow the installation of

conventional luminaries. In addition to integral showcase lighting separate ambient lighting is invariably required. Depending on the required atmosphere and the illuminance laid down in curatorial stipulations, ambient lighting may range from a lighting level just above the level of the showcase lighting down to orientation light produced by spill light from the showcases (Ganslandt, 1995). Lighting strategies vary according to the size, position, and the material of the showcase. Shaw (1994) discusses showcase lighting as follows:

With a display case all the preceding points are condensed into a very small space and it is therefore important to discuss case lighting with the exhibition designers early on in a project to ensure that there will be enough space for the lighting. There can be no general rule as to what is the correct solution as this will depend on the nature of the objects to be displayed and their positions within the case. What can be said is that the box full of fluorescent tubes at the top of the case is rarely satisfactory. Low voltage dichroic lamps can be used to great effect from within a top box providing they are freely positionable, however undimmed direct light from even a 20W dichroic lamp will exceed most conservation levels. The trick is to use careful focusing to spill light onto delicate objects rather than light them directly as this allows you to minimize dimming and so retain a good color temperature. When it comes to larger or undercut three dimensional objects top box lighting on its own is very limited and in these situations it is often necessary to introduce light within the case from other angles. Putting any light source in the same airtight space as the exhibit is unacceptable due to the inevitable heat rise within the case. This is where Fiber Optics are at their most useful as it is possible to position the fiber ends inside the case without risking heat build up or unacceptable Ultraviolet and lighting levels (Figure 4.10). Fiber Optics can also be effectively used within the top box of a display case, alongside low voltage lamps, where there are particularly light sensitive objects such as paper or textiles.

Free-standing objects such as sculptures and furniture have a wide variance in material thus careful decisions should be made concerning conservation categories. While inorganic material like stone and metal are insensitive, organic materials are highly sensitive to light. The important thing is that the lighting should render the form and texture of the object (Figure 4.11). Sculptures generally require directed light to reveal the three-dimensional quality and surface structure. They are usually illuminated by spotlights or recessed directional spotlights.

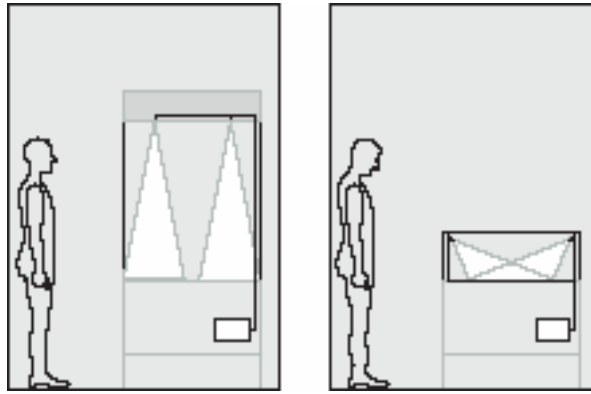

Figure 4.10. Showcase lighting using a fibre optic system. One central light source supplies a number of light heads. Integral lighting of this kind can be installed in the smallest of spaces. (Source: Ganslandt and Hoffmann 1992)



Figure 4.11. The lighting should render the form and the texture of the sculpture. (Source: Fördergemeinschaft Gutes Licht 2002)

If the exhibition is housed by a historical building then a set of constraints will be available in terms of lighting to preserve the architectural and historical value of the building. The major constraint will be the limited options available for providing an electrical supply to lighting equipment such as wiring. The wiring should be as invisible as possible. One of the other constraints is that it may not be permitted to mount the lighting equipment on any surface of the building. On these occasions floor-standing luminaries (Figure 4.12) should be preferred or a solution with minimum touch should be developed (Figure 4.13). The process of designing lighting for a museum or gallery in a historical building may sometimes require taking advice from authorities on historical buildings.

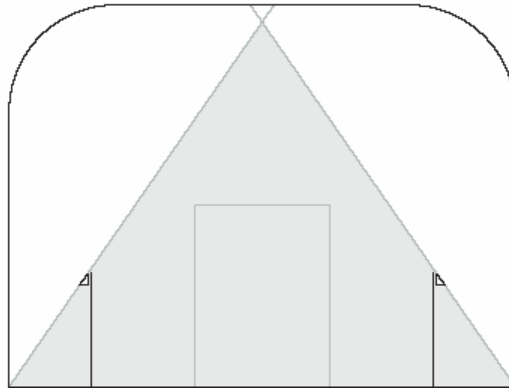

Figure 4.12. Floor-standing luminaries.
(Source: Ganslandt and Hoffmann 1992)

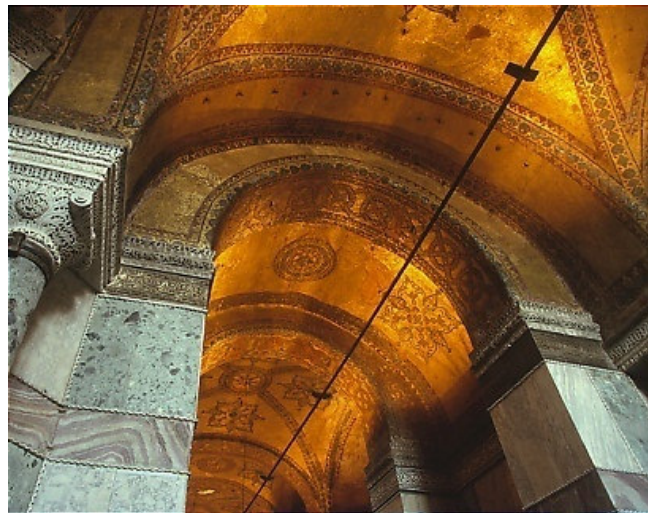

Figure 4.13. Hagia Sophia, Istanbul. The halogen uplights are mounted onto a rail with as minimum connection detail on walls as possible.

4.1.2. Qualitative Requirements

As mentioned before, “lighting quality” in this dissertation is described as a phenomenon which accompanies spatial quality with its peculiarities far more than vision. In order to develop successfully lit environments, one need to consider the third factor alongside architecture and light, which is perceptual psychology. Light is not/should not be just a physical quantity that provided sufficient illumination. It is a decisive factor in human perception. The ability of lighting is not only to make things and spaces around us visible, but also to determine the priority and the way individual objects in our visual environment are seen.

With Kelly in the fifties the issue of quantity is replaced by different qualities of light, a series of functions that lighting had to serve the needs of the perceiver. Kelly

developed a basic description of the various functions of light as a medium for conveying information. He described the first and basic form of light as ambient light. This is the light that provides for the general illumination of our environment. It guarantees that the surrounding space, objects and persons in it, are visible. This form of overall, uniform lighting ensures that we can orient ourselves and carry out general tasks.

To achieve differentiation, a second form of lighting is required which Kelly described as focal glow. This is the first instance where light becomes an active participant in conveying information. One important aspect that is taken into account here is the fact that our attention is automatically drawn towards brightly lit areas. It is therefore possible to arrange the mass of information contained in an environment via the appropriate distribution of brightness. This also applies to orientation within space – e.g. the ability to distinguish quickly between a main entrance and a side entrance – and for the accentuation of objects, as we find in product displays or the emphasizing of the most valuable sculpture in a collection (Marsteller 1987).

Light is necessary in museums and art galleries not only for viewing exhibitions, and safety but also to provide a comfortable, pleasing, and informative viewing environment for people. Lighting must be designed to help create an attractive general appearance in space and also the feeling of well-being of the visitor.

Research in varying disciplines has showed that, well-being in terms of lighting is mostly related to the distribution of light in the space, color rendition, color temperature, visual access, and ability to control light. If the case is a museum or an exhibition hall, letting visitors control lighting may not be possible because of the requirements of conservation. Moreover museum is a public space, and one's subjective decisions may interfere with the subjective decisions of others. However, it is possible to determine general lighting preferences of people by means of questionnaires and other data collection methods which are available.

Correct distribution of light and shadow makes for clearer perception of three-dimensional objects and thus helps us get our bearings in a room (Fördergemeinschaft 2002). Without shadow we see objects only as two-dimensional images. Direction of light is important to permit 3D projection and to give objects depth. A bright room with nothing but diffuse lighting and no shadows makes for a monotonous impression and causes lack of orientation, poor definition of objects and difficulty in estimating distances which makes people feel uncomfortable. However, harsh shadows should be

used carefully because on the contrary, they could render objects unrecognizable and sometimes even could be unsafe in certain locations such as stairs. Figure 4.14 shows the effect of shadows in perceiving three dimensional objects.

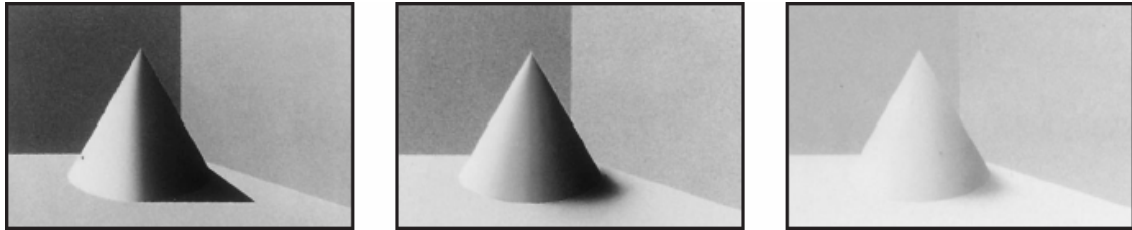

Figure 4.14. Perception of three-dimensional forms and surface structures under different light-shadow conditions. Left: Directed light produces pronounced shadows and strong shaping effects. Forms and surface structures are accentuated, while details can be concealed by the shadows. Middle: Lighting that consists of both diffuse and directed lighting produces soft shadows. Forms and surface structures can be recognized clearly. There are no disturbing shadows. Right: Diffuse lighting produces negligible shadowing. Shapes and surface structures are poorly recognizable. (Source: Ganslandt and Hoffmann 1992)

Museums and art galleries could often include requirements for more dramatic style lighting which sometimes require theatrical lighting techniques and equipment to provide particular points of emphasis, or dynamic moving effects to enhance the spatial experience (Shaw 1994). In the theatre, the question of illuminance levels and uniform lighting is of minor importance. The aim of stage lighting is not to render the stage or any of the technical equipment it contains visible. Besides, it aims at altering the perception of the audience with changing scenes and moods. Stage lighting goes much further in its intentions than architectural lighting does by creating illusions, whereas architectural lighting is concerned with rendering real structures visible. Nevertheless stage lighting serves as an example for architectural lighting. It identifies methods of producing differentiated lighting effects and the instruments required to create these particular effects.

Another important difference between diffuse and concentrated light is the characteristic related to the accurate and pleasant viewing of color. Diffuse light tends to “desaturate” colors and imparts dullness to them (Kaufmann 1966) (Figure 4.15). Directional light strongly renders saturation in colors. Paintings, such as Osman Hamdi’s, which have rich surface textures and colors, would be perceived inaccurately under such diffuse or uniform way of lighting. According to Taylor (1993) the difference between diffuse and concentrated light shows up markedly on paintings having more than one coat or varnish. He continues that both concentrated and diffuse light together are desirable for full appreciation of the surface characteristics of art works.



Figure 4.15. The diffuse lighting system in Istanbul Modern desaturates colors of art objects.

In some cases the differentiation between building and display lighting is not always clearly designed as where the reflected light from the display lighting provides the building lighting. It is important for the designer to consider both elements of the lighting to ensure that the electrically-lit gallery space appears pleasant and attractive in addition to providing appropriate lighting for the exhibits (CIBSE 1994). Depending on the architectural character of the gallery and on how exhibits are to be displayed and lit, the building lighting may constitute some form of concealed or indirect lighting which balances the light pattern to ensure an appropriate light contrast between the exhibits and the gallery space (CIBSE 1994). The aim of the lighting in such spaces should be to provide a pattern of light where the exhibits are the brightest part of the field of view. Without a visual contrast between the exhibit and background lighting, a gallery could appear dull.

Typically, the contrast between the illuminance on the exhibits and general lighting of the gallery is 3:1. If the illuminance on the exhibits is significantly greater than the levels on the background, viewing exhibits becomes difficult. This is because of the level of illuminance on the exhibit will be much brighter than the level of visual adaptation of the viewer. However where more visually dramatic effect is required, and a high level of visibility is not important, the brightness ratio can be greater than 3:1, such as 10:1 or 15:1.

The purpose of gallery lighting is to present the exhibits in such a way that they may be studied and enjoyed. In most cases this means providing a lighting system that enables fine detail to be examined and reveals the form, color, and texture of the object. In some cases, the overall appearance of the display may be more important than the visibility of the individual exhibits, where “effects” lighting may be required. So, before installation, the general lighting requirements of the display must be discussed carefully. Each exhibition requires unique solutions, thus lighting in a gallery cannot be fixed and stable, unless it is a permanent-exhibit gallery.

Color rendition is another important criterion for museums. It affects the percentage of appearance of the object with its real color. Lamp types with high color renditions, such as tungsten halogen, fluorescent, and metal halide, must be preferred when illuminating museums. Light sources with a CRI above 90 are considered to be very good, while those with below 80 are not appropriate for museum and gallery lighting installations. As color temperature, except the JIS Standards the typical lighting is 3000-4000 K at 200-300 lx. A recent experiment by Scuello (2003) found that the general preference of the observers in lighting of the museums is 3600 K at 200 lx.

However there could be some cases that color rendition should bear less importance than the general visual characteristics of the exhibition. Furthermore colored light could be used dramatically as an effective and enriching tool for service spaces in museum and art galleries. Designers must be aware of the properties of color in terms of psychophysical methodologies. Mattiello (2004: p. 190) discusses color and its contributions to lighting as follows:

In the field of lighting research it has mostly aimed to solve aspects of visibility and comfort, while in the field of color attempts have been made to solve the needs of design, style and fashion, but have not always been based on verifiable data and/or criteria. This has led some to believe that “everything is possible”, while others take the view that it is a “topic for specialists”. However, both views are misguided. Thanks to the labor of qualified architects and designers, and with the evidence of their work all around us, no doubt remains today as to the importance of their research. In particular, psychophysical methodology applied to the analysis of individual or multiple variables, has allowed certain criteria to be established and basic aspects to be resolved both in the field of color and in lighting, and although few persons are interested in color and light *per se*, the importance of these investigations in solving basic aspects which contribute to human comfort is today widely recognized. Therefore, it appears that these investigations have a prosperous future ahead of them in helping us to understand and improve fundamental aspects of life such as health, the economy, security and even emotion and feeling.

Another important requirement of museums and art galleries in terms of lighting is to design a flexible system. Even permanent exhibitions go through changes in amount of material and the way they are displayed. For art galleries a new exhibition means a requirement for a new lighting system. Conventionally this can be provided by track systems. It is not the only solution, however. For example, in the Collective Gallery in Edinburgh, lighting designer Kevan Shaw designed a steel ceiling where spotlights with magnetic bases provide the lighting with ultimate positioning flexibility.

4.2. Evaluation of the Data

This part undertakes an analysis of the two lighting systems and their effects on spatial dynamics under the guidance of the pre-given evaluation methodology which includes the three basic sections of the functional, physiological, and psychological aspects. In the light of the pre-research concerning the requirements of lighting in museums and art galleries several changes were made in the evaluation methodology as seen in Figure 4.16.

4.2.1. Functional Aspects

The objects that are subject to the exhibit are poster printouts with informative texts. All posters have thin transparent plastic coating which helps reduce thermal effects. However, it does not supply any protection from photochemical damage which means change in color. According to the standards formed by varying authorities, the level of illuminance for organic materials such as papers, and prints should not exceed 50 lx. It is necessary to mention that lamps used in the halogen spotlighting system have a cold-light reflector, which reduces the heat approximately 66%, and a UV filter, which stops the UV emission produced by the lamp. Fluorescent bulbs on the other hand do not produce any heat, and they are of low ultraviolet-emitting type. In order to calculate the task surface illuminations in the exhibition hall in APIKAM four calculation surfaces (CS) were utilized in Dialux. The amount of the calculation surfaces derives from the variety of the horizontal illuminance levels supplied by the lighting systems, which means all photometric results for bright, semi-bright, and dark

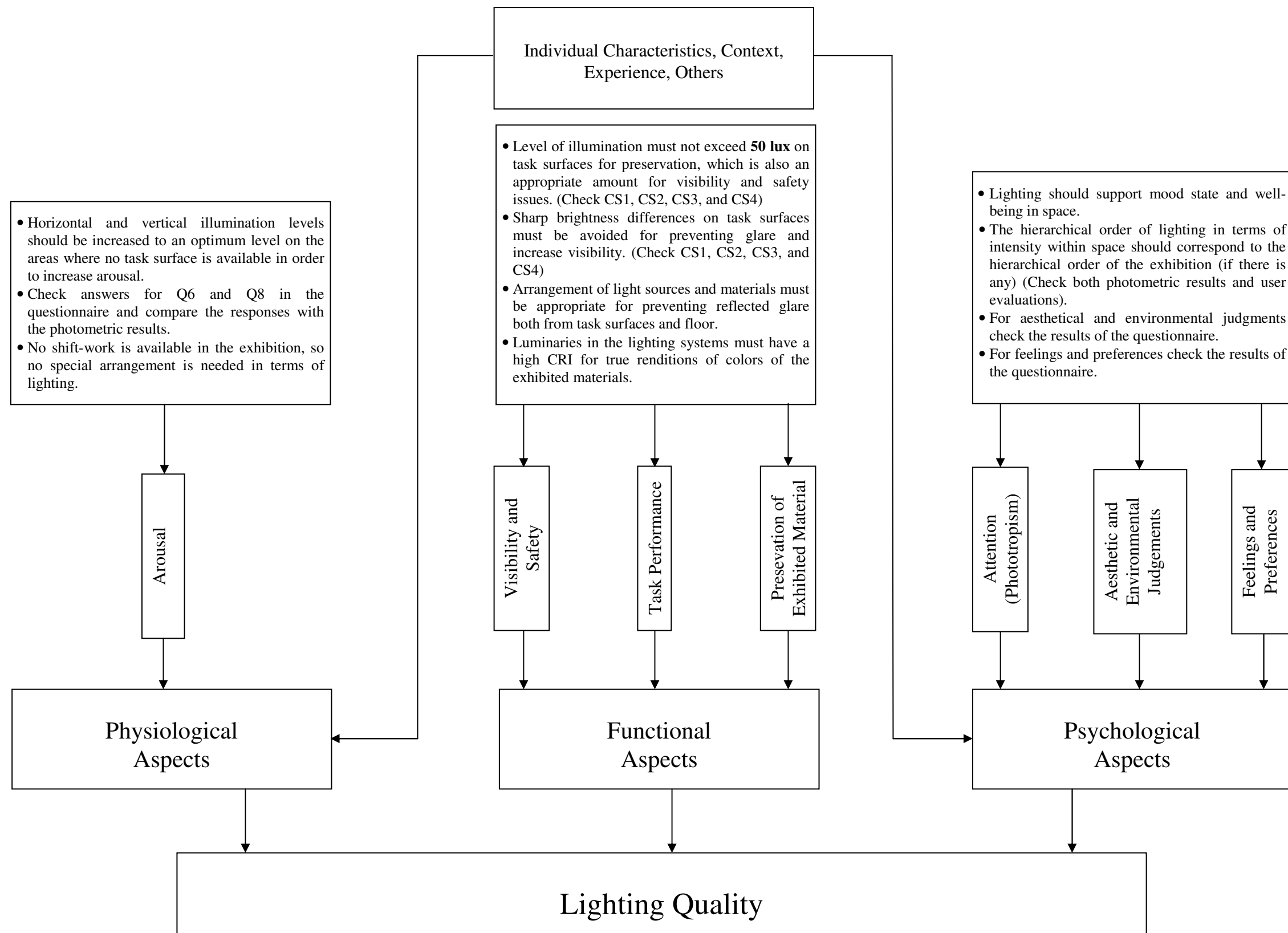

Figure 4.16. Diagram of the Evaluation Methodology for Artificial Lighting Quality of APIKAM

surfaces are included in the evaluation process. Figure 4.17 shows the placement of calculation surfaces for recessed fluorescent lighting system and Table 4.5 lists their general photometric properties.

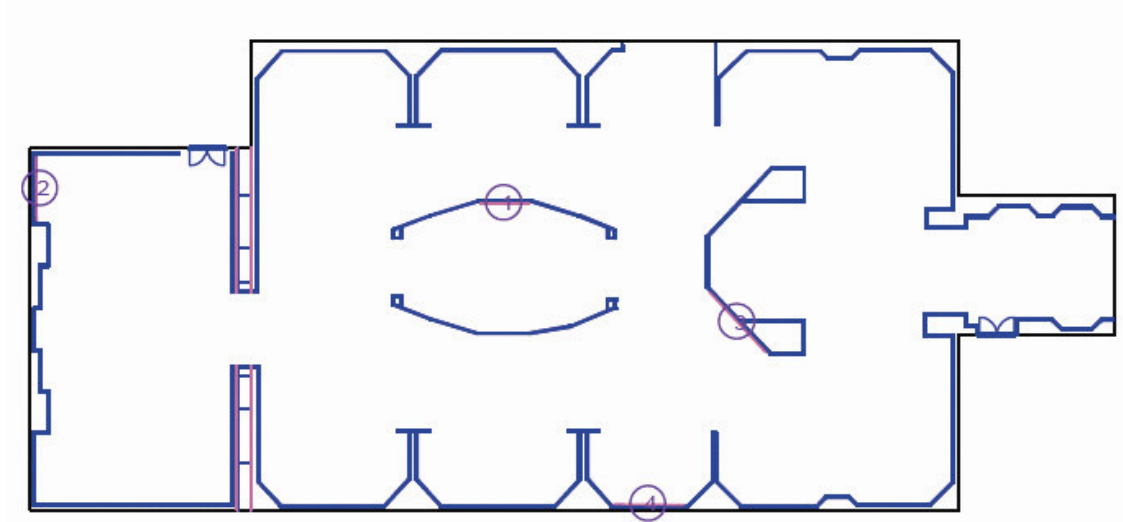

Figure 4.17. Placement of calculation surfaces both lighting systems in the exhibition

Table 4.5. Calculation surface list for recessed fluorescent lighting system

No	Designation	Grid	E_{av} [lx]	E_{min} [lx]	E_{max} [lx]	$u0$	E_{min}/E_{max}
1	Calculation Surface 1	16x16	251	241	293	0.96	0.82
2	Calculation Surface 2	8x8	100	88	113	0.88	0.78
3	Calculation Surface 3	32x32	180	153	234	0.85	0.65
4	Calculation Surface 4	16x16	153	141	169	0.92	0.83

CS1 is placed to the brightest location, CS2 is placed to the darkest location, CS3 and CS4 are placed to semi-bright locations in the exhibition.

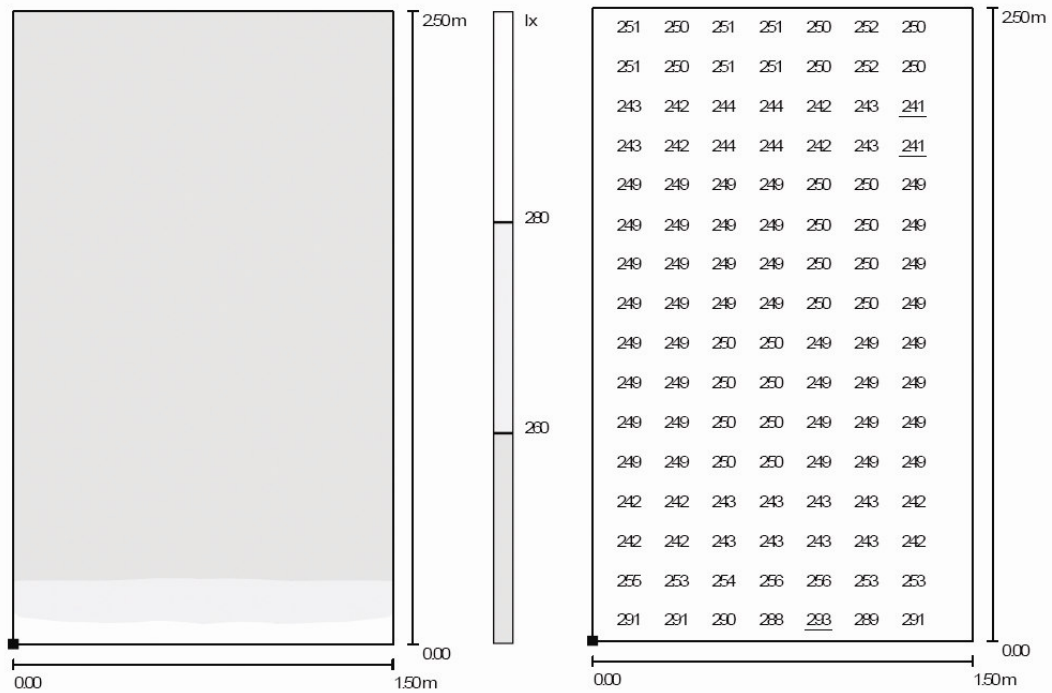

Figure 4.18. Photometric results for CS1 (lx) (Recessed Fluorescent)

As seen in

Figure 4.18 shown in Figure 4.18, the level of illumination on the surface is between 241 and 251 lx, which is higher than the recommended level. There is no variety in brightness on task surface as shown in grayscale image.

Figure 4.19 shows the results for CS2. The level of illumination is 88 lx at minimum and 113 lx at maximum, which are again higher than acceptable levels in terms of conservation. The variations in brightness are disturbing because they vertically create zones without providing a constant level at the level of eyesight. However, there is no risk for glare since the difference is only 37 lx at maximum.

Figure 4.20 shows the results for CS3. The amount of illumination on the surface is between 153 and 234 lx. This surface too is subject to vertical brightness differences of negligible amount on the level of eyesight.

Figure 4.21 shows the results for CS4. The level of illumination is 141 lx at minimum and 169 lx at maximum. The average illumination is 153 lx. All four calculation surfaces are brighter than the acceptable level which is 50 lx.

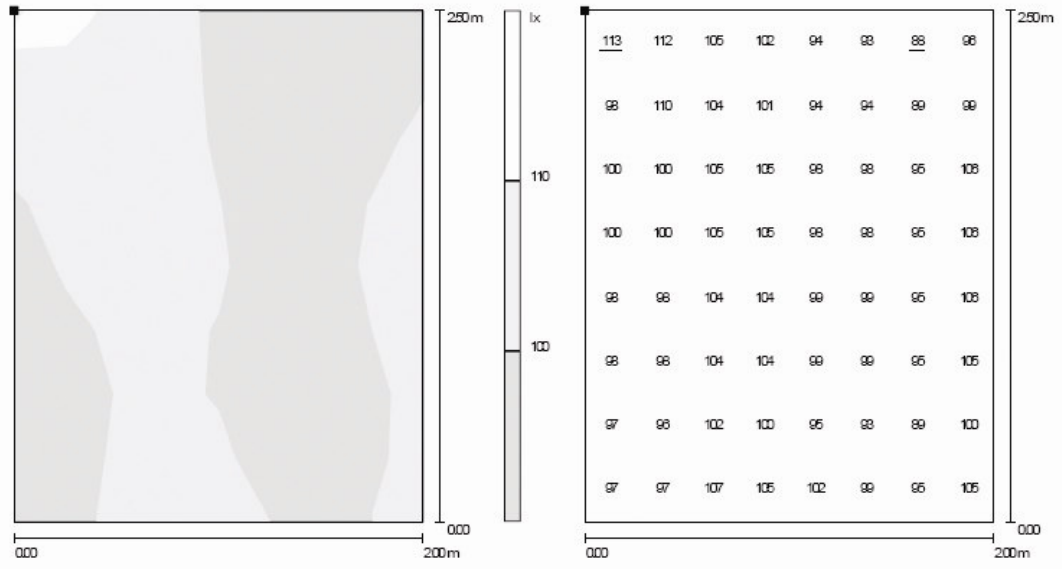

Figure 4.19. Photometric results for CS2 (lx) (Recessed Fluorescent)

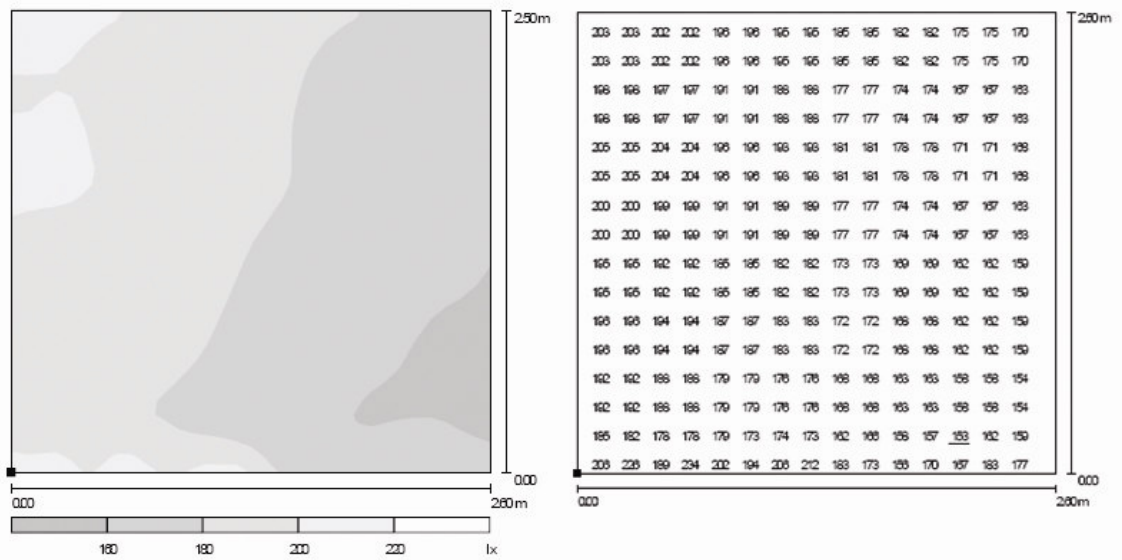

Figure 4.20. Photometric results for CS3 (lx) (Recessed Fluorescent)

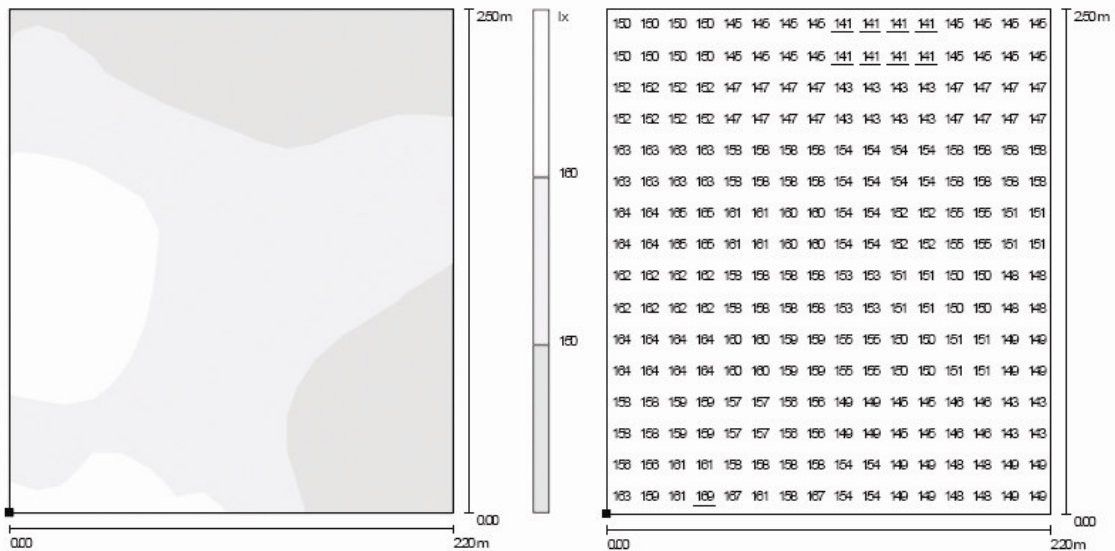

Figure 4.21. Photometric results for CS4 (lx) (Recessed Fluorescent)

Table 4.6. Calculation surface list for recessed halogen spotlighting system

No	Designation	Grid	E_{av} [lx]	E_{min} [lx]	E_{max} [lx]	u_0	E_{min}/E_{max}
1	Calculation Surface 1	32x32	640	512	882	0.80	0.58
2	Calculation Surface 2	32x32	315	243	413	0.77	0.59
3	Calculation Surface 3	32x32	436	345	543	0.79	0.64
4	Calculation Surface 4	32x32	527	449	638	0.85	0.70

Table 4.6 lists the general photometric properties of the calculation surfaces for halogen spotlighting system. CS1 and CS4 are placed to the brightest locations in the exhibition. CS2 is placed to the darkest location and CS3 is placed to a semi-bright location in the exhibition. Figure 4.22 shows the photometric results for CS1. The level of illumination is 512 lx at minimum and 882 lx at maximum. The variations in brightness at the level of eyesight would definitely create glare because of the sharp transitions from 621 lx to 882 lx. The same disturbing effect occurs in the CS3 and CS4 too, as shown in Figure 4.24 and Figure 4.25.

Figure 4.23 show the photometric results for CS2. Illumination range is between 243 and 413 lx with an average illumination of 315 lx which is the lowest illumination supplied by the halogen spotlighting system. Surface in the level of eyesight is again subject to glare, with sharp brightness differences as shown in the grayscale visualization.

The amount of light on all four calculations surfaces are higher than the recommended level.

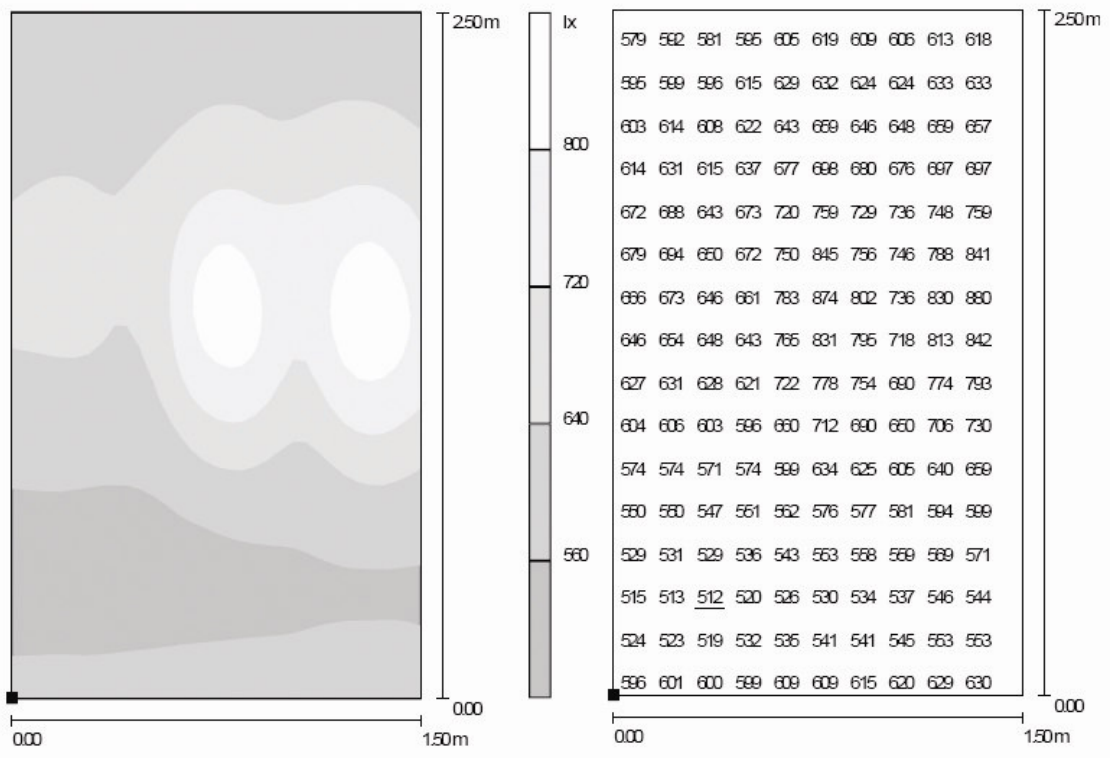

Figure 4.22. Photometric results for CS1 (lx) (Halogen Spotlighting)

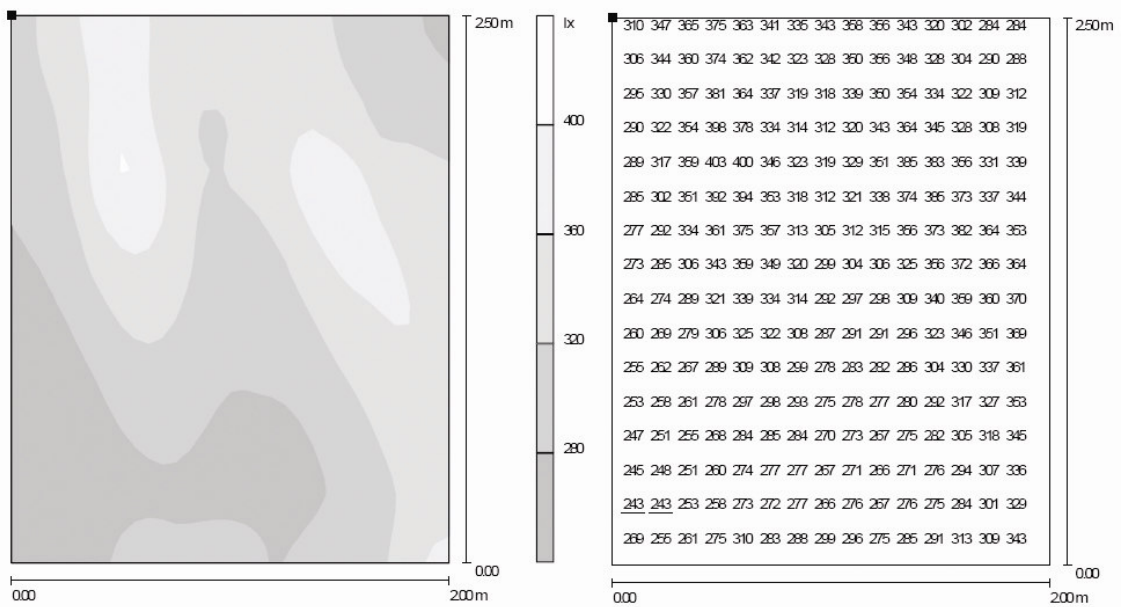

Figure 4.23. Photometric results for CS2 (lx) (Halogen Spotlighting)

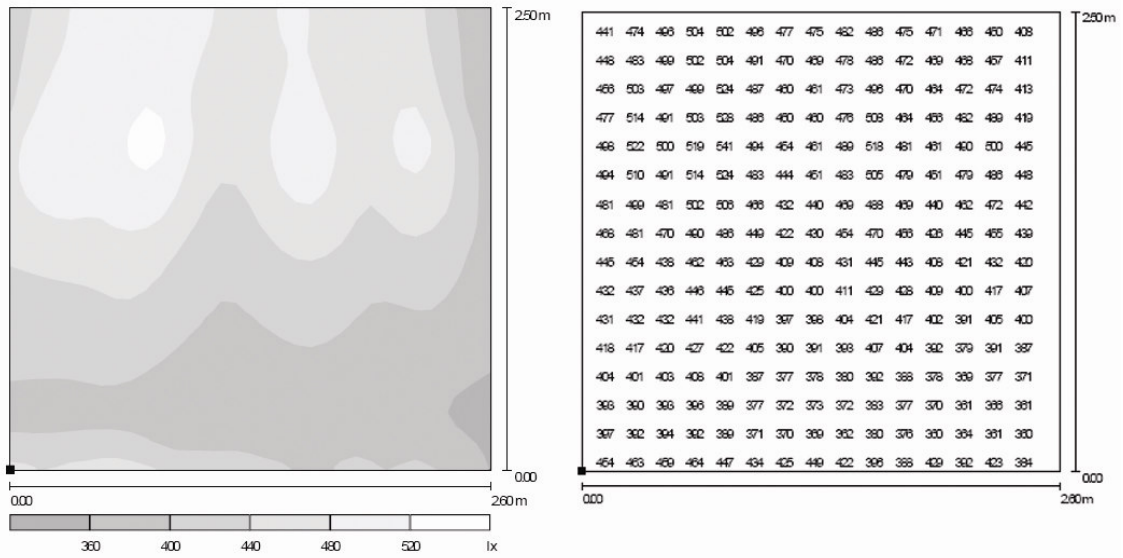

Figure 4.24. Photometric results for CS3 (lx) (Halogen Spotlighting)

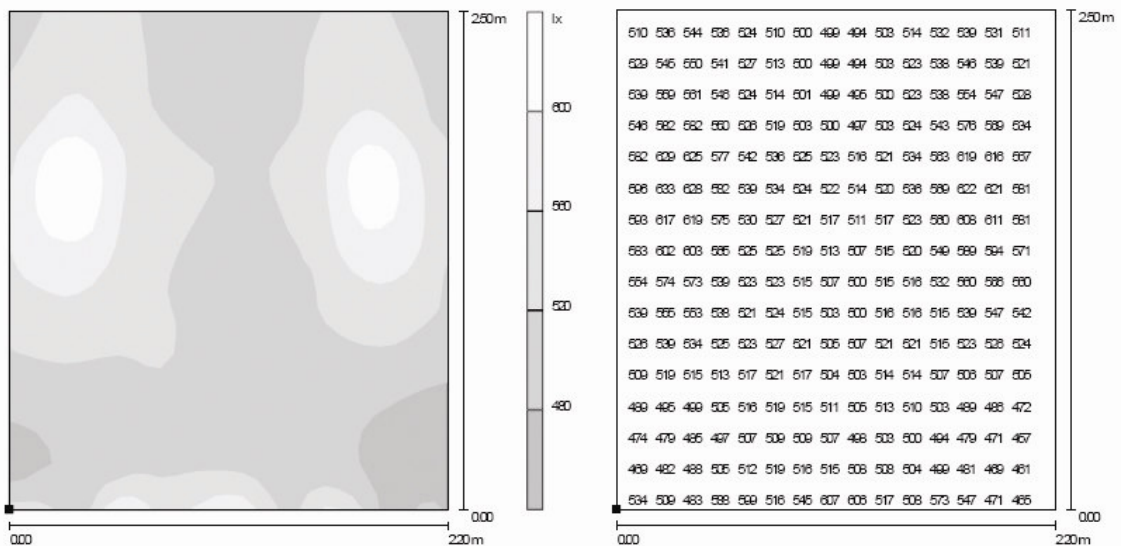

Figure 4.25. Photometric results for CS4 (lx) (Halogen Spotlighting)

Another problem in the exhibition is the reflected glare from the floor, which occurs under both lighting systems. The floor is covered by granite tiles with a very high level of reflectance which is almost 70 %. This causes for almost all locations in the exhibition a reflected image of the light source on the floor (Figure 4.26 and Figure 4.27), which distracts the attention from the task surfaces and exposes the users to bright lights of sources.



Figure 4.26. Reflected glare from floor under recessed fluorescent lighting



Figure 4.27. Reflected glare from floor under halogen spotlighting

Vertical task surfaces are subject to reflected glare, too. Glare occurs mostly on posters which are dark in color. On certain angles these posters act like mirrors where viewers can easily see the image of light sources and themselves (Figure 4.28 and Figure 4.29).



Figure 4.28. Reflected glare on vertical panels under recessed fluorescent lighting



Figure 4.29. Reflected glare on vertical panels under halogen spotlighting. Both the light sources and the standing person are reflected on the surface.

Recessed fluorescent lighting system is fixed and does not offer the ability for repositioning. Even when a permanent exhibition is at stake, the exhibition can go through some changes in time and there would be a need for change in the arrangement of lighting. The halogen spotlighting system provides flexibility with tracks, thus could be adapted to any possible spatial variation.

4.2.2. Physiological Aspects

The lighting systems in the exhibition differ in their effects on the level of arousal. As discussed before, high level of illumination triggers arousal. The illumination supplied by the recessed fluorescent lighting system varies between 88 lx and 420 lx and the average illumination is 211 lx within the space, whereas the illumination supplied by halogen spotlighting system is between 243 lx and 1185 lx. Although the neutral white fluorescent light source with 4000 K triggers more arousal than the reddish warm halogen light source with 2900 K, the amount of light here plays the main role. Below are the results of the two questions from the survey in the feelings section which deals with arousal levels.

Q6. I feel aroused-unaroused under this lighting arrangement.

Table 4.7. Mean and SD for aroused-unaroused

Lighting	n	Mean	SD
Recessed Fluorescent Lighting	67	4.0	0.79
Halogen Spotlighting	67	1.6	0.66

Table 4.7 shows that the mean for recessed fluorescent system is 4.0 which means slightly unaroused, and 1.6 for halogen spotlighting which means aroused. The standard deviations are 0.79 and 0.66. Table 4.8 shows the t-test results with the hypothesis of “recessed fluorescent lighting \neq halogen spotlighting” .

Table 4.8. T-Test for aroused-unaroused

Lighting	n	Mean	SD	SE
Recessed Fluorescent Lighting	67	4.0	0.8	0.10
Halogen Spotlighting	67	1.5	0.6	0.08
Difference	67	2.5	1.1	0.14
Difference between means	2.5			
95% CI	2.2	to 2.8		
t statistic	17.81			
2-tailed p	<0.0001			

The hypothesis is true, because the p value is smaller than 0.01. The halogen spotlighting system creates more arousal than recessed fluorescent lighting system. Table 4.9 shows the variance for fluorescent system according to age. As age increases level of unarousal increases, too.

Table 4.9. Variance for Age (aroused-unaroused)

Lighting	n	Mean	SD
Fluorescent by Age - B 20-30	39	3.9	0.84
Fluorescent by Age - B 30-35	17	4.0	0.71
Fluorescent by Age - B 35-40	8	4.3	0.71
Fluorescent by Age - B 40-50	3	5.0	-
Halogen by Age - B 20-30	39	1.6	0.64
Halogen by Age - B 30-35	17	1.5	0.72
Halogen by Age - B 35-40	8	1.4	0.74
Halogen by Age - B 40-50	3	2.0	-

Q8. I feel sleepy-wideawake under this lighting arrangement.

Table 4.10. Mean and SD for sleepy-wideawake

Lighting	n	Mean	SD
Recessed Fluorescent Lighting	67	1.8	0.97
Halogen Spotlighting	67	4.0	0.87

Table 4.10 shows that the mean for recessed fluorescent system is 1.8 which means slightly sleepy, and 4.0 for halogen spotlighting which means slightly wideawake. The standard deviations are 0.97 and 0.87. Table 4.11 shows the t-test results with the hypothesis of “recessed fluorescent lighting \neq halogen spotlighting” .

Table 4.11. T-test for sleepy-wideawake

Lighting	n	Mean	SD	SE
Recessed Fluorescent Lighting	67	1.8	1.0	0.12
Halogen Spotlighting	67	4.0	0.9	0.11
Difference	67	-2.2	1.4	0.17
Difference between means	-2.2			
95% CI	-2.5	to -1.8		
t statistic	-12.97			
2-tailed p	<0.0001			

The hypothesis is true, because the p value is smaller than 0.01. The halogen spotlighting system creates more arousal than recessed fluorescent lighting system.

As mentioned in the functional evaluation, certain locations in the exhibition are subject to glare especially under halogen spotlighting. It is widely known that glare acts as a stressor and causes severe health problems such as headache and fatigue. However, visitors are not exposed to glare as much as they get physiologically affected, because it is an exhibition, a temporary space for a quick visit.

Fluorescent light sources are generally also known as flicker sources. The ballasts of fluorescent light sources need to be checked regularly every six months by a specialist and replaced if they cause flicker.

4.2.3. Psychological Aspects

4.2.3.1. Attention

The posters in the exhibition in APIKAM have a hierarchical order. In other words, there is a sequential categorization for the posters, so each poster has a distinct place in the order for viewing. For group visitors an official guide who works for APIKAM supervises through the whole exhibition. However, others who visit the exhibition by themselves must find their own way. This part investigates whether the lighting conditions within the space help or guide them correctly or not and whether the lighting conditions give them a feeling of orientation or not.

The visiting order for the poster is shown in Figure 4.30. As mentioned before in Chapter 3, as brightness increases in a specific direction, people tend to walk to that direction. With this assumption one expects a gradual increase in brightness down from point 1 to 3, then to the right from point 3 to 7, then again to the right point 8 which in the cubical in the middle of the exhibition. Another gradual increase must be provided from point 9 to 10 and finally the brightest area must be the point 11 in the adjacent rectangle.

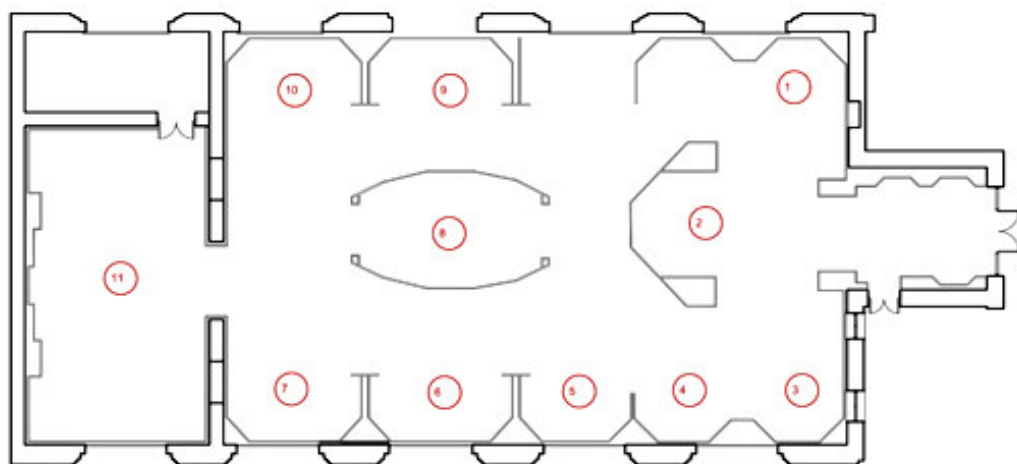

Figure 4.30. Visiting order for the exhibition hall in APIKAM

If we take a look at the photometric results for ceiling recessed fluorescent box system (Figure 4.31 and Figure 4.32), we see that there is an increase in the average horizontal illuminance from 180 lx to 360 lx between points 1 and 2.

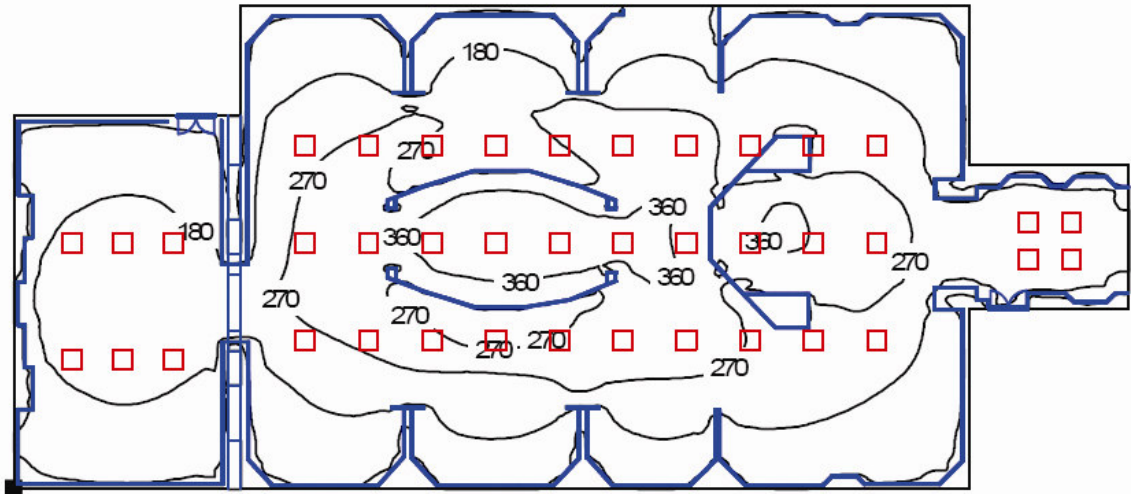

Figure 4.31. Horizontal illumination levels for recessed fluorescent in isolines (lx)

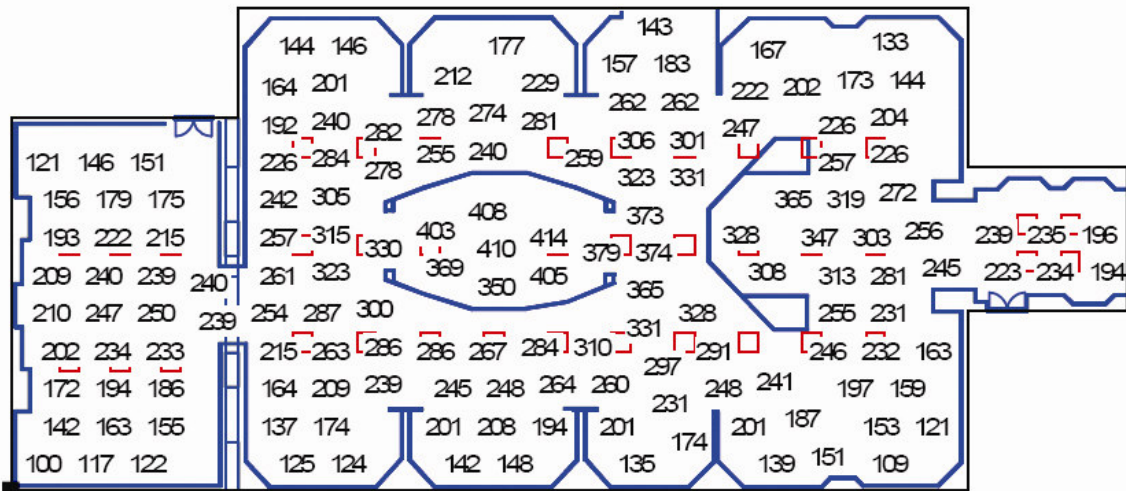

Figure 4.32. Horizontal illumination levels for recessed fluorescent in value chart (lx)

The average horizontal illuminance drops again to 180 lx at point 3 and stays stable at 180 lx till point 7. Again it increases to 360 lx at point 8 and drops to 180 at point 9 and 10. The adjacent rectangle has an average illuminance level of 180 lx and 240 lx at the point of entrance. The continuity is interrupted between points 2 and 3 then between 8 and 9.

The photometric results for halogen spotlighting systems are quite different (Figure 4.33 and Figure 4.34). The level of horizontal illuminance at point 1 is 480 lx in average and it increases to 662 lx at point 2. It drops to an average of 480 lx at points 3 and 4. We notice an increase to 720 lx at point 5 and then a decrease to 480 lx at points 6 and 7. Point 8 has an average illuminance of 600 lx and it drops to 480 lx at point 9 and 10. At Point 11

the horizontal illuminance is at 240 lx. Again in halogen spotlighting system the continuity interrupted between points 2 and 3, 6 and 7, then 10 and 11.

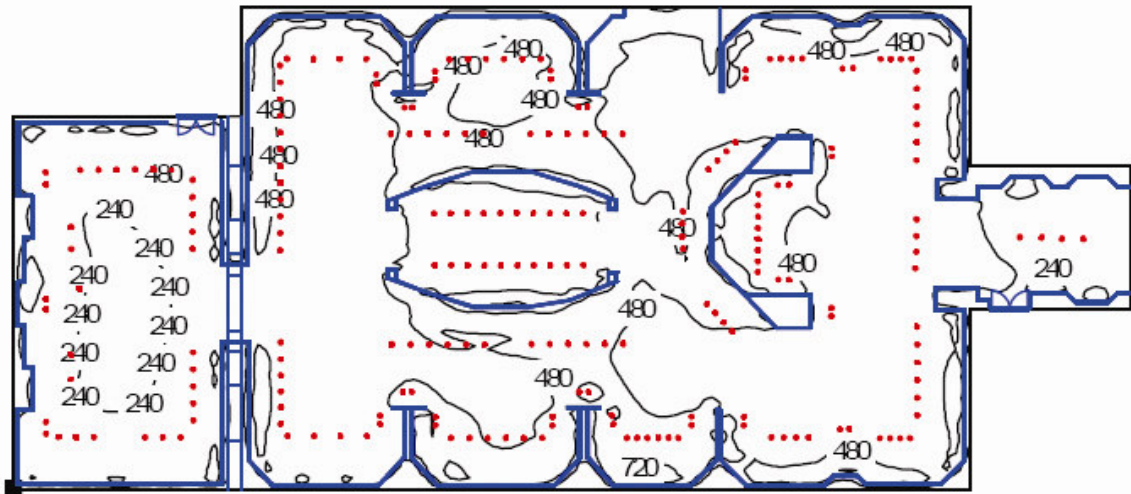

Figure 4.33. Horizontal illumination levels for halogen spotlighting in isolines (lx)

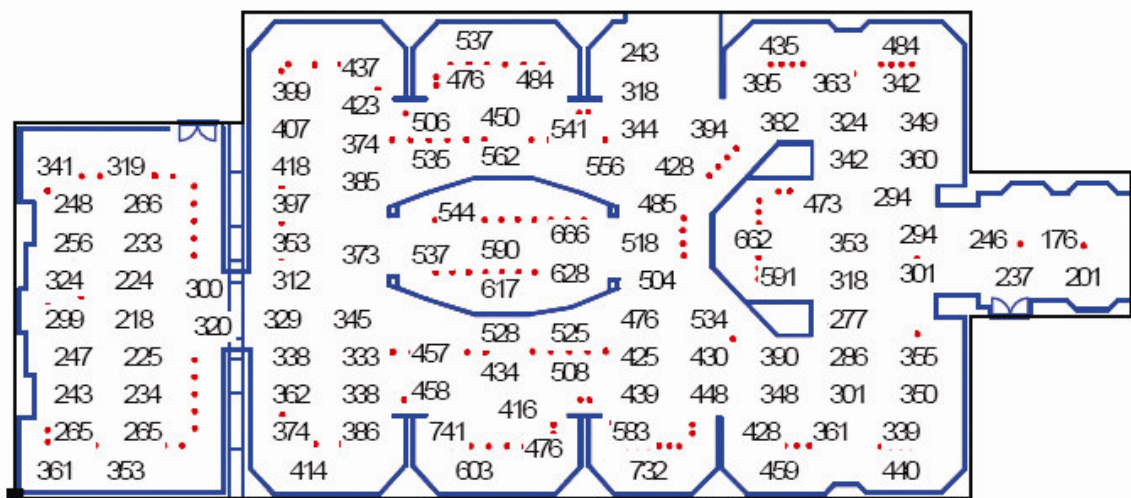

Figure 4.34. Horizontal illumination levels for halogen spotlighting in value chart (lx)

One of the two questions of the fifth section in the survey was asking the subjects to stand on two pre-given points as shown “sp1” and “sp2” on Figure 4.35 and to decide to take one of the many directions listed on the map. For sp1 under fluorescent lighting system, 29 of the subjects decided to take d1; 25 of them decided to take d2 and the rest checked the “it doesn’t matter” option. For sp2 under fluorescent lighting system no one decided to take d1, 35 of them decided to take d2, 21 of them decided to take d3, and for the rest it did not matter. These results are consistent with the

photometric results and show people’s tendency in following light. Both lighting systems need to be improved at certain locations in terms of the brightness pattern which directly affects the attention cycle within the exhibition.

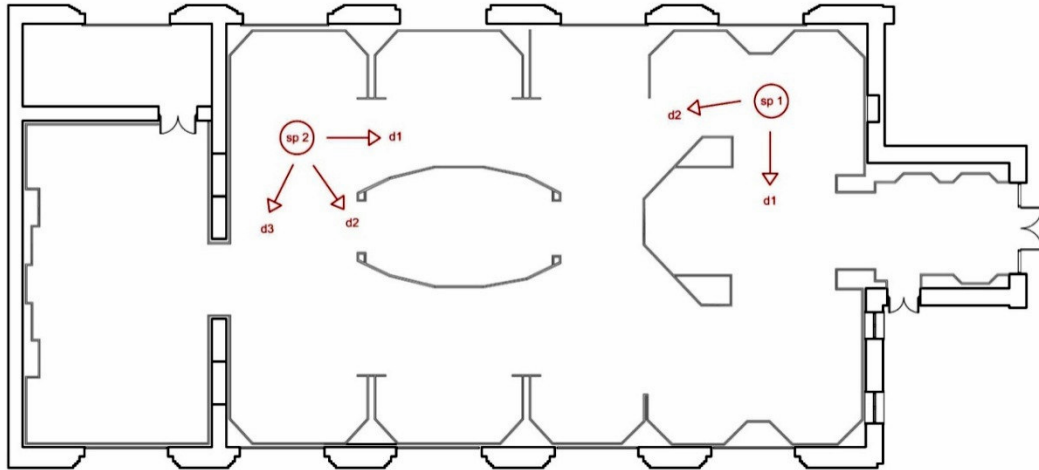

Figure 4.35. Perceptual preferences and attention study in survey

4.2.3.2. Aesthetic and Environmental Judgments

The third section of the survey was related to aesthetical and environmental judgments. Subjects’ evaluations concerning the effects of two lighting systems on the general appearance of the space were revealed. The results for the selected four questions are as follows:

Q1. Perception of the form of the gallery under this lighting arrangement is strong-weak

Table 4.12. Mean and SD for perception of form (strong-weak)

Lighting	n	Mean	SD
Resecced Fluorescent Lighting	67	3.2	1.01
Halogen Spotlighting	67	1.7	0.73

Table 4.12 shows that the mean for recessed fluorescent system is 3.2 which means neutral and 1.7 for halogen spotlighting which means slightly strong. Table 4.13

shows the results of the t-test which was run to ascertain whether there is a significant difference for these parameters between the two lighting systems. The hypothesis is “recessed fluorescent lighting \neq halogen spotlighting” .

Table 4.13. T-test for perception of form (strong-weak)

Lighting	n	Mean	SD	SE
Recessed Fluorescent Lighting	67	3.2	1.0	0.12
Halogen Spotlighting	67	1.7	0.7	0.09
Difference	67	1.5	1.2	0.14
Difference between means	1.5			
95% CI	1.2	to 1.8		
t statistic	10.63			
2-tailed p	<0.0001			

The p value at the end of table verifies that the hypothesis is true as being smaller than 0.01.

Q2. Perception of the structural elements under this lighting arrangement is strong-weak

Table 4.14. Mean and SD for perception of structural elements (strong-weak)

Lighting	n	Mean	SD
Recessed Fluorescent Lighting	67	2.8	1.11
Halogen Spotlighting	67	2.3	1.16

Table 4.14 shows that the mean for recessed fluorescent system is 2.8 which means neutral and 2.3 for halogen spotlighting which means slightly strong. Table 4.15 shows the results of the t-test with the hypothesis of “recessed fluorescent lighting \neq halogen spotlighting” .

Table 4.15. T-test for perception of structural elements (strong-weak)

Lighting	n	Mean	SD	SE
Recessed Fluorescent Lighting	67	2.8	1.1	0.14
Halogen Spotlighting	67	2.3	1.2	0.14
Difference	67	0.5	1.4	0.17
Difference between means	0.5			
95% CI	0.2	to 0.9		
t statistic	2.91			
2-tailed p	0.0050			

The p value shows that the hypothesis is not true.

Q3. Perception of details [materials of architectural components and furnishing and their characteristics such as texture and color] of the gallery under this lighting arrangement is strong-weak

Table 4.16. Mean and SD for the Perception of details

Lighting	n	Mean	SD
Recessed Fluorescent Lighting	67	2.6	1.19
Halogen Spotlighting	67	2.3	1.15

Table 4.16 shows that the mean for recessed fluorescent system is 2.6 which means neutral and 2.3 for halogen spotlighting which means slightly strong. Table 4.17 shows the results of the t-test with the hypothesis of “recessed fluorescent lighting \neq halogen spotlighting” .

Table 4.17. T-test for perception of details

Lighting	n	Mean	SD	SE
Recessed Fluorescent Lighting	67	2.6	1.2	0.15
Halogen Spotlighting	67	2.3	1.2	0.14
Difference	67	0.3	1.2	0.15
Difference between means	0.3			
95% CI	0.1	to 0.6		
t statistic	2.34			
2-tailed p	0.0223			

The p value shows that the hypothesis is not true.

Q4. The gallery under this lighting arrangement appears as cozy-cold

Table 4.18. Mean and SD for cozy-cold

Lighting	n	Mean	SD
Recessed Fluorescent Lighting	67	3.8	0.83
Halogen Spotlighting	67	1.4	0.60

Table 4.18 shows that the mean for recessed fluorescent system is 3.8 which means slightly cold and 1.4 for halogen spotlighting which means slightly cozy. Table 4.19 shows the results of the t-test which was run to ascertain whether there is a significant difference for these parameters between the two lighting systems. The hypothesis is “recessed fluorescent lighting \neq halogen spotlighting” .

Table 4.19. T-test for cozy-cold

Lighting	n	Mean	SD	SE
Recessed Fluorescent Lighting	67	3.8	0.8	0.10
Halogen Spotlighting	67	1.4	0.6	0.07
Difference	67	2.5	1.1	0.14
Difference between means	2.5			
95% CI	2.2	to 2.7		
t statistic	17.59			
2-tailed p	<0.0001			

The p value at the end of table verifies that the hypothesis is true as being smaller than 0.01. These results are consistent with the color temperatures of the bulbs used for the two lighting systems. The color temperatures are 4000 K and 2900 K for fluorescent and halogen bulbs respectively. As mentioned before in Chapter 3, light sources with a lower color temperature stimulate a feeling of warmth and coziness.

Q5. The gallery under this lighting arrangement appears as **interesting-dull**

Table 4.20. Mean and SD for interesting-dull

Lighting	n	Mean	SD
Recessed Fluorescent Lighting	67	3.8	0.81
Halogen Spotlighting	67	1.4	0.54

Table 4.20 shows that the mean for recessed fluorescent system is 3.8 which means slightly dull and 1.4 for halogen spotlighting which means slightly interesting. The standard deviations are 0.81 and 0.54. Table 4.21 shows the t-test results with the hypothesis of “recessed fluorescent lighting \neq halogen spotlighting” .

Table 4.21. T-test for interesting-dull

Lighting	n	Mean	SD	SE
Recessed Fluorescent Lighting	67	3.8	0.8	0.10
Halogen Spotlighting	67	1.4	0.5	0.07
Difference	67	2.4	1.0	0.13
Difference between means	2.4			
95% CI	2.2	to 2.7		
t statistic	18.91			
2-tailed p	<0.0001			

The p value at the end of table verifies that the hypothesis is true as being smaller than 0.01.

Q6. The gallery under this lighting arrangement appears as **inviting-repulsive**

Table 4.22. Mean and SD for inviting-repulsive

Lighting	n	Mean	SD
Recessed Fluorescent Lighting	67	3.8	0.87
Halogen Spotlighting	67	1.4	0.61

Table 4.22 shows that the mean for recessed fluorescent system is 3.8 which means slightly repulsive and 1.4 for halogen spotlighting which means slightly inviting. The standard deviations are 0.87 and 0.61. Table 4.23 shows the t-test results with the hypothesis of “recessed fluorescent lighting \neq halogen spotlighting” .

Table 4.23. T-test for inviting-repulsive

Lighting	n	Mean	SD	SE
Recessed Fluorescent Lighting	67	3.8	0.9	0.11
Halogen Spotlighting	67	1.4	0.6	0.07
Difference	67	2.3	1.1	0.14
Difference between means	2.3			
95% CI	2.1	to 2.6		
t statistic	16.70			
2-tailed p	<0.0001			

The p value at the end of table verifies that the hypothesis is true as being smaller than 0.01.

Q7. I like the gallery under this lighting arrangement

Table 4.24. Mean and SD for “I like the gallery”

Lighting	n	Mean	SD
Recessed Fluorescent Lighting	67	3.8	0.80
Halogen Spotlighting	67	1.3	0.44

Table 4.24 shows that the mean for recessed fluorescent system is 3.8 which means slightly no and 1.3 for halogen spotlighting which means yes. The standard deviations are 0.80 and 0.44. Table 4.25 shows the t-test results with the hypothesis of “recessed fluorescent lighting \neq halogen spotlighting” .

Table 4.25. T-test for “I like the gallery”

Lighting	n	Mean	SD	SE
Recessed Fluorescent Lighting	67	3.8	0.8	0.10
Halogen Spotlighting	67	1.3	0.4	0.05
Difference	67	2.5	0.9	0.11
Difference between means	2.5			
95% CI	2.3	to 2.7		
t statistic	22.13			
2-tailed p	<0.0001			

The p value at the end of the table verifies that the hypothesis is true as being smaller than 0.01.

User evaluations show that halogen spotlighting is the preferred one in terms of aesthetic and environmental judgments. For all the four questions in survey halogen spotlighting system received more positive response than the recessed fluorescent lighting system.

4.1.3.3. Feelings and Preferences

A P.A.D. scale with fourteen pairs of adjectives is used to measure emotional outcomes. Four pairs of them are used to control subjects in terms of whether they are consistent in their answers or not. The results are as follows:

Q1. I feel happy-unhappy under this lighting arrangement.

Table 4.26. Mean and SD for happy-unhappy

Lighting	n	Mean	SD
Recessed Fluorescent Lighting	67	3.3	0.86
Halogen Spotlighting	67	1.7	0.70

Table 4.26 shows that the mean for recessed fluorescent system is 3.3 which means neutral; in other words, it bears no effect on happiness; and 1.7 for halogen spotlighting which means slightly happy. The standard deviations are 0.86 and 0.70. Table 4.27 shows the t-test results with the hypothesis of “recessed fluorescent lighting \neq halogen spotlighting” .

Table 4.27. T-test for happy-unhappy

Lighting	n	Mean	SD	SE
Recessed Fluorescent Lighting	67	3.3	0.9	0.10
Halogen Spotlighting	67	1.7	0.7	0.09
Difference	67	1.6	1.1	0.13
Difference between means	1.6			
95% CI	1.4	to 1.9		
t statistic	12.47			
2-tailed p	<0.0001			

The p value at the end of table verifies that the hypothesis is true as being smaller than 0.01.

Q2. I feel annoyed-pleased under this lighting arrangement.

Table 4.28. Mean and SD for annoyed-pleased

Lighting	n	Mean	SD
Recessed Fluorescent Lighting	67	2.9	0.61
Halogen Spotlighting	67	4.5	0.61

Table 4.28 shows that the mean for recessed fluorescent system is 2.9 which means neutral; in other words, lighting has no effect on these feelings; and 4.5 for halogen spotlighting which means extremely pleased. The standard deviations are 0.61 for both lighting system. Table 4.29 shows the t-test results with the hypothesis of “recessed fluorescent lighting \neq halogen spotlighting” .

Table 4.29. T-test for annoyed-pleased

Lighting	n	Mean	SD	SE
Recessed Fluorescent Lighting	67	2.9	0.6	0.07
Halogen Spotlighting	67	4.5	0.6	0.07
Difference	67	-1.6	0.9	0.11
Difference between means	-1.6			
95% CI	-1.9	to -1.4		
t statistic	-15.53			
2-tailed p	<0.0001			

The p value at the end of table verifies that the hypothesis is true as being smaller than 0.01.

Q3. I feel relaxed-tense under this lighting arrangement.

Table 4.30. Mean and SD for relaxed-tense

Lighting	n	Mean	SD
Recessed Fluorescent Lighting	67	3.2	0.97
Halogen Spotlighting	67	1.6	0.76

Table 4.30 shows that the mean for recessed fluorescent system is 3.2 which means neutral; in other words, lighting has no effect on these feelings; and 1.6 for halogen spotlighting which means slightly relaxed. The standard deviations are 0.97 and 0.76. Table 4.31 shows the t-test results with the hypothesis of “recessed fluorescent lighting \neq halogen spotlighting” .

Table 4.31. T-test for relaxed-tense

Lighting	n	Mean	SD	SE
Recessed Fluorescent Lighting	67	3.2	1.0	0.12
Halogen Spotlighting	67	1.6	0.7	0.09
Difference	67	1.7	1.2	0.14
Difference between means	1.6			
95% CI	1.3	to 1.9		
t statistic	11.06			
2-tailed p	<0.0001			

The hypothesis is true. Table 4.32 shows the variance in feelings according to age. Subjects between ages 40-50 rated their feelings as slightly tense under fluorescent lighting while others rated as neutral.

Table 4.32. Variance related to age (relaxed-tense)

Lighting	n	Mean	SD
Fluorescent by Age - B 20-30	39	3.1	0.86
Fluorescent by Age - B 30-35	17	3.4	1.06
Fluorescent by Age - B 35-40	8	3.4	1.19
Fluorescent by Age - B 40-50	3	4.0	1.00
Halogen by Age - B 20-30	39	1.5	0.64
Halogen by Age - B 30-35	17	1.5	0.51
Halogen by Age - B 35-40	8	1.9	1.13
Halogen by Age - B 40-50	3	2.7	1.53

Q4. I feel autonomous-guided under this lighting arrangement.

(Compare with the results of Q7 and Q11)

Table 4.33. Mean and SD for autonomous-guided

Lighting	n	Mean	SD
Recessed Fluorescent Lighting	67	2.0	0.91
Halogen Spotlighting	67	1.8	0.74

Table 4.33 shows that the mean for recessed fluorescent system is 2.0 which means slightly autonomous, and 1.8 for halogen spotlighting which again means slightly autonomous. The standard deviations are 0.91 and 0.74. Table 4.34 shows the t-test results with the hypothesis of “recessed fluorescent lighting \neq halogen spotlighting” .

Table 4.34. T-test for autonomous-guided

Lighting	n	Mean	SD	SE
Recessed Fluorescent Lighting	67	2.0	0.9	0.11
Halogen Spotlighting	67	1.8	0.7	0.09
Difference	67	0.1	1.0	0.13
Difference between means	0.1			
95% CI	-0.1	to 0.4		
t statistic	1.07			
2-tailed p	0.2889			

The hypothesis is not true as the p value is bigger than 0.01. There is clear distinction between two lighting systems for this feeling.

Q5. I feel hopeful-despairing under this lighting arrangement.

Table 4.35. Mean and SD for hopeful-despairing

Lighting	n	Mean	SD
Recessed Fluorescent Lighting	67	3.0	0.75
Halogen Spotlighting	67	2.6	0.70

Table 4.35 shows that the mean for recessed fluorescent system is 3.0 which means neutral, and 2.6 for halogen spotlighting which means neutral again. The standard deviations are 0.75 and 0.70. Table 4.36 shows the t-test results with the hypothesis of “recessed fluorescent lighting \neq halogen spotlighting” .

Table 4.36. T-test for hopeful-despairing

Lighting	n	Mean	SD	SE
Recessed Fluorescent Lighting	67	3.0	0.7	0.09
Halogen Spotlighting	67	2.6	0.7	0.09
Difference	67	0.4	0.9	0.11
Difference between means	0.4			
95% CI	0.2	to 0.7		
t statistic	3.97			
2-tailed p	0.0002			

The hypothesis is not true; both lighting systems do not have a particular effect for these feelings.

Q6. I feel aroused-unaroused under this lighting arrangement.(For results see page 88)

Q7. I feel dominant-submissive under this lighting arrangement.

(Compare with the results of Q4 and Q11)

Table 4.37. Mean and SD for dominant-submissive

Lighting	n	Mean	SD
Recessed Fluorescent Lighting	66	3.4	0.86
Halogen Spotlighting	67	2.5	1.06

Table 4.37 shows that the mean for recessed fluorescent system is 3.4 which is between neutral and slightly submissive, and 2.5 for halogen spotlighting which is between neutral and slightly dominant. The standard deviations are 0.86 and 1.06. Table 4.38 shows the t-test results with the hypothesis of “recessed fluorescent lighting \neq halogen spotlighting” . The n value is 66 in the tables since one subject did not mark anything for fluorescent lighting.

Table 4.38. T-test for dominant-submissive

Lighting	n	Mean	SD	SE
Recessed Fluorescent Lighting	66	3.4	0.9	0.11
Halogen Spotlighting	66	2.5	1.1	0.13
Difference	66	0.8	1.5	0.19
Difference between means	0.8			
95% CI	0.5	to 1.2		
t statistic	4.53			
2-tailed p	<0.0001			

The hypothesis is true, because the p value is smaller than 0.01. This analysis shows that halogen spotlighting has a slightly more effect than recessed fluorescent lighting on the feeling of dominancy.

Table 4.39. Variance related to sex (dominant-submissive)

Lighting	n	Mean	SD
Fluorescent by Sex - F	29	3.1	0.82
Fluorescent by Sex - M	37	3.6	0.83
Halogen by Sex - F	29	2.6	1.15
Halogen by Sex - M	38	2.4	1.01

Table 4.39 shows the variance in feelings related to sexual differences. Male subjects feel more submissive than female subjects under recessed fluorescent lighting system.

Table 4.40. Variance related to age (dominant-submissive)

Lighting	n	Mean	SD
Fluorescent by Age - B 20-30	38	3.4	0.71
Fluorescent by Age - B 30-35	17	3.5	1.07
Fluorescent by Age - B 35-40	8	3.5	1.07
Fluorescent by Age - B 40-50	3	2.7	0.58
Halogen by Age - B 20-30	39	2.6	1.07
Halogen by Age - B 30-35	17	2.3	0.85
Halogen by Age - B 35-40	8	2.0	0.76
Halogen by Age - B 40-50	3	4.3	1.15

Table 4.40 shows the variance in feelings related to age. Subjects aged between 20 and 30 rated their feelings as neutral under the halogen spotlighting, while subjects between 30 and 40 feel more dominant. The significant variance comes from subjects aged between 40 and 50 with a rating of 4.3, which means slightly submissive.

Q8. I feel **sleepy-wideawake** under this lighting arrangement. (For results see page 90)

Q9. I feel talkative-shy under this lighting arrangement.

Table 4.41. Mean and SD for talkative-shy

Lighting	n	Mean	SD
Recessed Fluorescent Lighting	67	3.0	0.82
Halogen Spotlighting	67	1.8	0.84

Table 4.41 shows that the mean for recessed fluorescent system is 3.0 which means that lighting has no effect on these feelings, and 1.8 for halogen spotlighting which means slightly talkative. The standard deviations are 0.82 and 0.84. Table 4.42 shows the t-test results with the hypothesis of “recessed fluorescent lighting \neq halogen spotlighting” .

Table 4.42. T-test for talkative-shy

Lighting	n	Mean	SD	SE
Recessed Fluorescent Lighting	67	3.0	0.8	0.10
Halogen Spotlighting	67	1.8	0.8	0.10
Difference	67	1.2	1.2	0.15
Difference between means	1.2			
95% CI	0.9	to 1.5		
t statistic	7.85			
2-tailed p	<0.0001			

The hypothesis is true, because the p value is smaller than 0.01.

Q10. I feel excited-calm under this lighting arrangement.

Table 4.43. Mean and SD for excited-calm

Lighting	n	Mean	SD
Recessed Fluorescent Lighting	67	3.9	0.95
Halogen Spotlighting	67	1.9	0.74

Table 4.43 shows that the mean for recessed fluorescent system is 3.9 which means slightly calm and 1.9 for halogen spotlighting which means slightly excited. The standard deviations are 0.95 and 0.74. Table 4.44 shows the t-test results with the hypothesis of “recessed fluorescent lighting \neq halogen spotlighting” .

Table 4.44. T-test for excited-calm

Lighting	n	Mean	SD	SE
Recessed Fluorescent Lighting	67	3.9	1.0	0.12
Halogen Spotlighting	67	1.9	0.7	0.09
Difference	67	2.0	1.4	0.17
Difference between means	2.0			
95% CI	1.7	to 2.4		
t statistic	12.17			
2-tailed p	<0.0001			

The hypothesis is true, since the p value is smaller than 0.01.

Q11. I feel controlling-controlled under this lighting arrangement.

(Compare with the results of **Q4** and **Q7**)

Table 4.45. Mean and SD for controlling-controlled

Lighting	n	Mean	SD
Recessed Fluorescent Lighting	67	2.7	0.83
Halogen Spotlighting	67	2.6	0.76

Table 4.45 shows that the mean for recessed fluorescent system is 2.7 which stands between neutral and controlling, and 2.6 for halogen spotlighting which again stands between neutral and controlling. The standard deviations are 0.83 and 0.76. Table 4.46 shows the t-test results with the hypothesis of “recessed fluorescent lighting \neq halogen spotlighting” .

Table 4.46. T-test for controlling-controlled

Lighting	n	Mean	SD	SE
Recessed Fluorescent Lighting	67	2.7	0.8	0.10
Halogen Spotlighting	67	2.6	0.8	0.09
Difference	67	0.2	1.2	0.15
Difference between means	0.2			
95% CI	-0.1	to 0.5		
t statistic	1.10			
2-tailed p	0.2770			

The hypothesis is not true as the p value is bigger than 0.01. There is clear distinction between two lighting systems for this feeling.

Q12. I feel satisfied-unsatisfied under this lighting arrangement.

Table 4.47. Mean and SD for satisfied-unsatisfied

Lighting	n	Mean	SD
Recessed Fluorescent Lighting	67	3.9	0.99
Halogen Spotlighting	67	1.7	0.74

Table 4.47 shows that the mean for recessed fluorescent system is 3.9 which means slightly unsatisfied, and 1.7 for halogen spotlighting which means slightly satisfied. The standard deviations are 0.99 and 0.74. Table 4.48 shows the t-test results with the hypothesis of “recessed fluorescent lighting \neq halogen spotlighting” .

Table 4.48. T-test for satisfied-unsatisfied

Lighting	n	Mean	SD	SE
Recessed Fluorescent Lighting	67	3.9	1.0	0.12
Halogen Spotlighting	67	1.7	0.7	0.09
Difference	67	2.1	1.3	0.16
Difference between means	2.1			
95% CI	1.8	to 2.5		
t statistic	13.72			
2-tailed p	<0.0001			

The hypothesis is true, since the p value is smaller than 0.01. Table 4.49 shows the variance in feelings according to age. Subjects aged between 35 and 40 feel neutral under recessed fluorescent lighting system, while the rest feel slightly and extremely unsatisfied.

Table 4. 49. Variance related to age (satisfied-unsatisfied)

Lighting	n	Mean	SD
Fluorescent by Age - B 20-30	39	3.8	1.04
Fluorescent by Age - B 30-35	17	4.1	0.83
Fluorescent by Age - B 35-40	8	3.1	0.83
Fluorescent by Age - B 40-50	3	4.7	0.58
Halogen by Age - B 20-30	39	1.7	0.66
Halogen by Age - B 30-35	17	2.0	0.94
Halogen by Age - B 35-40	8	1.4	0.52
Halogen by Age - B 40-50	3	1.3	0.58

Q13. I feel stable-depressed under this lighting arrangement.

Table 4.50. Mean and SD for stable-depressed

Lighting	n	Mean	SD
Recessed Fluorescent Lighting	67	3.5	1.09
Halogen Spotlighting	67	1.9	0.74

Table 4.50 shows that the mean for recessed fluorescent system is 3.5 which stands between neutral and slightly depressed, and 1.9 for halogen spotlighting which means slightly stable. The standard deviations are 1.09 and 0.74. Table 4.51 shows the t-test results with the hypothesis of “recessed fluorescent lighting \neq halogen spotlighting” .

Table 4.51. T-test for stable-depressed

Lighting	n	Mean	SD	SE
Recessed Fluorescent Lighting	67	3.5	1.1	0.13
Halogen Spotlighting	67	1.9	0.7	0.09
Difference	67	1.6	1.3	0.15
Difference between means	1.6			
95% CI	1.3	to 1.9		
t statistic	10.52			
2-tailed p	<0.0001			

The hypothesis is true, since the p value is smaller than 0.01.

Q14. I feel important-unimportant under this lighting arrangement.

Table 4.52. Mean and SD for important-unimportant

Lighting	n	Mean	SD
Recessed Fluorescent Lighting	67	2.0	0.98
Halogen Spotlighting	67	1.7	0.72

Table 4.52 shows that the mean for recessed fluorescent system is 2.0 which means slightly important, and 1.7 for halogen spotlighting which again means slightly important. The standard deviations are 0.98 and 0.72. Table 4.53 shows the t-test results with the hypothesis of “recessed fluorescent lighting \neq halogen spotlighting” .

Table 4.53. T-test for important-unimportant

Lighting	n	Mean	SD	SE
Recessed Fluorescent Lighting	67	2.0	1.0	0.12
Halogen Spotlighting	67	1.7	0.7	0.09
Difference	67	0.3	1.3	0.16
Difference between means	0.3			
95% CI	-0.1	to 0.6		
t statistic	1.60			
2-tailed p	0.1135			

The hypothesis is not true as the p value is bigger than 0.01.

4.1.4. Imperfections

Although environmental psychology do possess several studies which reveals the effects of lighting on human psychology and certain behaviors, it does not offer a variety in terms of architectural function. Most of the studies deal with office environments and try to expose the psychological impacts of lighting in reference to performance. There are a few works which were realized in other environments, such as libraries, hospitals, and factories, again with a tendency to increase performance. It is

not possible to meet any study of that kind which is realized where labor performance is of secondary importance, such as museums, art galleries, cafeterias, and others. This caused to prepare, perform, and evaluate all related measurement studies for the case, such as the survey, which prolonged the data collection process for this evaluation methodology. This creates a disadvantage in terms of time-management. The researchers of environmental psychology should expand their preferences in terms of spatial function and form a base of knowledge which would be beneficial for related studies.

The evaluation methodology reached at satisfying results for most of the criteria under functional, physiological, and psychological aspects and enabled a detailed judgment about quality of lighting in APIKAM. However it was insufficient to measure the effects of lighting on the perception of structural elements, materials, and their characteristics such as texture and color. The third part in the survey was dealing with the aesthetic and environmental judgments by means of eleven questions. Only and the last four questions that measure the direct influence of space on users were reached at satisfying results. Four other questions were related to the general appearance of lighting on spatial components, such as wall, ceiling, and floor, reached to consistent results too. However these four questions were asked only to test subject's reliability, because the answers for these four questions were already acquired by the photometric calculations. The first three questions were testing the effects of lighting on the perception of spatial components. Excluding the first question which was related to the perception of form, no satisfying results were acquired for the two questions in this section.

The survey was not successful in measuring the users' emotional responses in the case of the feeling of dominancy. Three questions concerning this feeling concluded at conflicting results.

Figure 4.36 and Figure 4.37 show the general problems of the lighting systems in APIKAM .

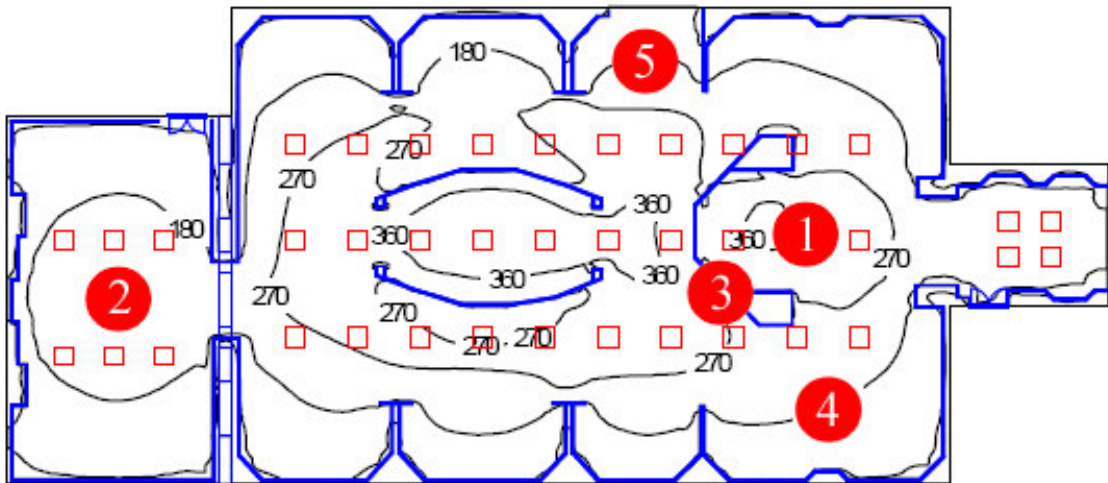

Figure 4.36. General problems under recessed fluorescent lighting system: **1.** The general level of illumination is high for the exhibition of organic-based materials. A dimmer system could be installed to reduce the amount of light. **2.** The lighting system is fixed and does not allow repositioning according to the changing lighting needs. **3.** Task surfaces are subject to glare related to the positions of light sources. No solution is possible, since the lighting system is fixed. **4.** The granite floor with a high reflectance factor creates glare. Another material with a low reflectance factor such as vinyl or wood should be selected. **5.** The distribution of light creates three separate uniformly lit areas which lead to an uninteresting and dull environment. Differentiation should be achieved through a dimmer system by changing the amount of light on certain places besides task surfaces.

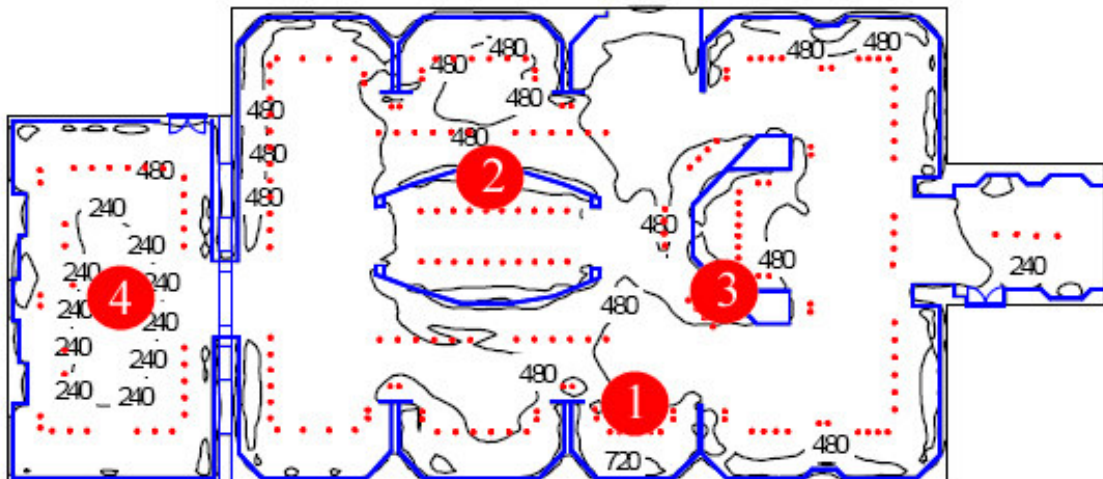

Figure 4.37. General problems under halogen spotlighting system: **1.** The general level of illumination is too high for the exhibition of organic-based materials. A dimmer system could be installed to reduce the amount of light. **2.** Task surfaces are subject to glare related to the harsh brightness differences on the surface. Brightness differences must be minimized. Variety should be achieved on certain locations other than task surfaces. **3.** Task surfaces are subject to glare related to the positions of light sources. The tracks allow the lighting system to be repositioned. **4.** The granite floor with a high reflectance factor creates glare. Another material with a low reflectance factor such as vinyl or wood should be selected.

CHAPTER 5

CONCLUSIONS

The evaluation methodology for artificial lighting quality was successfully operated on APIKAM and several results were acquired, which will help in interpreting and judging the quality of lighting supplied by two different lighting systems. The success and failure of the lighting systems were revealed according to the three aspects in the evaluation process, as functional, physiological, and psychological. This kind of an evaluation helped in determining what the deficiencies are in terms of lighting and what problems these deficiencies lead to both in terms of environmental conditions and experience within the space.

Functional aspects are concerned with visibility, thus safety; and task performance in relation to the amount of light, lighting systems or lamp types chosen, and check whether they are appropriate to the desired function or not. According to the regulations the amount of light must not exceed 50 lx, where organic-based materials such as paper prints are exhibited. Besides, the IR emissions should be controlled and UV emissions should be stopped to avoid the heating effect and photochemical reactions.

In the exhibition hall APIKAM the task surfaces are the vertical panels and there is a large variety in the amount of light they receive especially under halogen spotlighting systems. In order to make the evaluations easier, four calculation surfaces are utilized to measure the amount of light on the surfaces. The surfaces are placed on the brightest, darkest, and semi-bright locations within the exhibition. For recessed fluorescent lighting system, the amount of light on the surfaces varies between 88 lx and 293 lx, which are higher than the recommended level. Since it is too expensive to change the whole lighting system, a dimmer system could be installed which gives the ability to reduce the amount of light in the exhibition. This system should offer the ability of controlling each single fluorescent box so that it would be possible to equalize the intensity for each task surface to the recommended level. This will also generate the ability to create variety in the amount of light outside the task surfaces in the exhibition, such as walls, ceiling, and floor to achieve non-uniformity. Fluorescent light sources do not produce any heat. However, they emit too much radiation within the ultraviolet

spectrum. Although the ones used in the exhibition are of low UV emitting type, they nevertheless produce some UV emission which could be dangerous for the exhibited materials. A UV shield coating could be applied on the methacrylate flat diffuser for each box.

The situation is much worse for the halogen spotlighting system in terms of light intensity. The amount of light varies between 243 lx and 882 lx, which are far higher than the recommended level. The cold-light reflector of the sources reduces the heat by 66 % but at this intensity it will not be enough. The amount of light must be lowered with a dimmer system which is proposed for recessed fluorescent systems, too. The UV shield in the halogen bulbs stops the UV emission, so no further protection such as a UV coating is necessary.

Because of the high intensities especially in the halogen spotlighting system, some disturbing effects such as glare occur in the exhibition. Most of the task surface is subject to sharp transitions in terms of brightness. For example, the CS1 is subject to a transition from 621 lx to 880 lx at a height of 165 cm under halogen spotlighting system. Brightness pattern, or the non-uniform distribution of light is something valuable, but special attention must be paid that these varieties do not intersect on the task surfaces. Other surfaces such as walls, ceiling, floor, and some volumetric parts of the space could be utilized for that purpose. This problem also derives from the selection of the halogen bulb which has a beam angle of 10 degrees, which is more suitable for illuminating three dimensional objects. Since this angle is too narrow, bright circles occur on the task surfaces and this tires the eye of viewer because it is hard to adapt to the bright and dark contrast at this small scale.

Another problem is the reflected glare or veiling reflections that occur on the task surfaces for both lighting systems. Most of the task surface acts like a mirror and reflects the images of light sources and even the image of the viewer on dark colored posters. This problem is also expressed in the survey. 42 subjects reported that they noticed the reflection of themselves and light sources under both lighting systems on several vertical task surfaces.

The reason is the wrong placement of the light sources without constituting the optimum angle of incidence, which is 30 degrees for vertical tasks in museums. Halogen spotlighting system is mounted on tracks and therefore provides the ability to relocate the sources, but the recessed fluorescent lighting system is fixed and repositioning means to change the whole suspended ceiling above the exhibition.

Another solution might be to relocate the vertical task surfaces according to the fluorescent lighting system and try to minimize the spots where veiling reflections occur and then cover all task surfaces with antireflective coatings of highest quality and then relocate the halogen spotlighting system with respect to the new plan scheme of the exhibition.

The reflected glare is also available on the floor. The exhibition is covered with granite tiles which have a reflectance of 68 %. The floor is like a reflective pool on a sunny day and it is possible to see the whole pattern of light sources on the floor for both lighting systems. On most of the exhibition the floor is the main source for disturbing glare and it distracts the attention from the exhibition, whereas all attention should be directed on task surfaces. As a solution the floor could be covered with an alternative material, such as vinyl or wood, which has low degree of reflectance.

Both lighting systems failed in functional aspects for several reasons as explained above.

Physiological aspects are concerned with the effects of light on human physiology. The physiological effects besides arousal are directly related to the length of the period of one's exposure to light. On the other hand, there may be some employees, including museum security guards and others who are exposed to lighting conditions for longer periods of time. Besides, some museums are also open at night for certain days of the week, which as a result make shift-work a parameter of consideration in terms of lighting design. This particular exhibition hall generally welcomes short visits which are not enough to become physiologically affected. The exhibition hall of APIKAM is open only during the work hours and there are no employees in the exhibition hall, who are on duty whole day, so the health issue in regard to human physiology could be neglected for this particular case. Physiological aspects are considered only in terms of arousal in this exhibition hall.

As based on Eysenck's theory (1990) and other scientific works such as Biner's (1991) and Boyce's (1997), arousal levels are related to the amount of light and more light triggers more arousal. However, it is also important to point out that the arousal level should be on an optimal level to result in good performance. Like low arousal levels, very high arousal levels bear negative effect on performance related to a task. The other factor is the color of light, as cooler light of high color temperature triggers more arousal than warmer light of low color temperature.

In the exhibition hall of APIKAM the arousal level is higher under the halogen spotlighting system. The illumination supplied by the recessed fluorescent lighting system varies between 88 lx and 420 lx and the average illumination is 211 lx within the space, whereas the illumination supplied by halogen spotlighting system is between 243 lx and 1185 lx at an average of 402 lx. Although the neutral white fluorescent light source with 4000 K triggers more arousal than the reddish warm halogen light source with 2900 K, the amount of light here plays the main role.

The results of survey verify this situation, too. The preferences for the two adjective pairs in the survey as “aroused-unaroused” and “sleepy-wideawake” were pointed out that halogen spotlighting systems triggers more arousal than recessed fluorescent lighting system. For the first adjective pair, the mean for recessed fluorescent lighting is 4 and the mean for halogen spotlighting system is 1.6. A p-value which is smaller than 0.001 shows that halogen spotlighting is the one that creates arousal within the space. For the pair “sleepy-wideawake” the mean for recessed fluorescent system is 1.8 and the mean for halogen spotlighting is 4. The t-test yielded result at a p-value smaller than 0.001 and verified the validity of the hypothesis which was “recessed fluorescent lighting \neq halogen spotlighting” . Another interesting result for the arousal levels was that the decline of the arousal level related to the increase of age. The means were 3.9, 4.0, 4.3, and 5.0 respectively for the four age groups of 20-30, 30-35, 35-40, and 40-50.

Recessed fluorescent lighting system failed in physiological aspects as it triggers less arousal than halogen spotlighting system. In order to heighten the arousal level for fluorescent lighting system, the amount of light needs to increase, which comprises a mismatch with the need for preservation. However, the illumination level could be increased on certain locations without increasing the level on vertical task surfaces with the help of a dimmer system.

Psychological aspects are concerned with the psychological effect of light described under three main parts as attention, aesthetic and environmental judgments, and feelings.

Both lighting systems have failed in attention scale, because none of them supply continuity in the order of visual clues that match with the sequential order of the exhibition. The present brightness patterns supplied by lighting systems misguide the users in the exhibition in terms of attention cycle.

There is a considerable difference between the two lighting systems in their interactions with the architectural space. Recessed fluorescent lighting system supplies a uniform distribution of luminance on the task areas and a uniform horizontal illumination in the middle of space. There is significant drop in the horizontal illumination on both sides near the long walls for the large hall and near the short walls in the adjacent small hall, deriving from the location of the light sources. While the average horizontal illumination is at 360 lx in the middle of space, it drops to 270 lx and to 180 lx on both sides. This is misleading in terms of perceptual conditions as some parts of the space are perceived weaker than the rest, although it is not an intended situation. As mentioned before, non-uniform distribution of light is necessary with its contribution to space in terms of perceptual psychology, however not in this particular way. In this exhibition the recessed fluorescent lighting system creates three uniformly illuminated areas; gradually decreases in the amount of illumination, thus the level of perception decreases too, for the area where the illumination level is at minimum. The problem is that the lesser perceived area holds the larger percentage of the task area. In fact, the amount of light on darker areas is enough to see the posters and read the informative texts. However, those locations are not a point of interest anymore under this arrangement of light sources.

The illumination supplied by halogen spotlighting is much more satisfying in terms of environmental conditions. The lighting has a non-uniform character between 240 lx and 720 lx in average, and almost all of the vertical task surfaces are strongly perceived by the users in the exhibition. Moreover, the architectural information is strongly transmitted to the visitors.

The results of the survey show that subjects rated halogen spotlighting system as it creates a cozy, interesting, and inviting environment, and that they like the gallery more under halogen spotlighting system while they rated recessed fluorescent lighting system as it creates a cold, dull, and repulsive environment.

Results for feelings are more complex. Subjects rated that they feel happy, pleased, relaxed, aroused, talkative, excited, satisfied, and stable under halogen spotlighting system, while they feel sleepy, calm, and unsatisfied under recessed fluorescent lighting system.

Positive feelings are generally influenced by halogen spotlighting system. However, this does not mean that all negative feelings are influenced by recessed fluorescent lighting systems. The adjective pairs of happy-unhappy, annoyed-pleased,

hopeful-despairing, relaxed-tense, talkative-shy, and stable-depressed are rated as neutral under recessed fluorescent lighting system, which means this lighting system has neither a positive effect nor a negative effect for these pairs of feelings, while some of these feelings are positively influenced under halogen spotlighting system.

According to the results there is no clear distinction between the two lighting systems for the feeling pair of important-unimportant. Subjects feel important under both lighting systems. Some subjects reported during the survey that they felt important by being involved in this study. The results may have been affected by this feeling.

For the three scales which measure the dominancy the results were confusing. The results of the scales autonomous-guided and controlling-controlled showed that lighting systems have no effect on this feeling; they both rated near 3, which means neutral. However, the results of the scale of dominant-submissive points out halogen spotlighting system as stimulating dominancy on the subjects. The inconsistency between the results is unacceptable. That is why the results for all of these adjective pairs will not be counted.

Subjects aged between 40 and 50 feel tense under recessed fluorescent lighting system, while the rest have not been affected in the same way. For the scale of arousal-unarousal it is interesting to see that as age increases unarousal level increases too, under recessed fluorescent lighting system. The reason might be the declining visual abilities as age increases, but then what could be the reason of them feeling more aroused under halogen spotlighting system?

Both lighting systems have no influence on the feeling pair of hopeful-despairing. This pair is rated as 3 under recessed fluorescent system and 2.6 under halogen spotlighting system.

For the pair of satisfied-unsatisfied, subjects rated fluorescent system as slightly unsatisfied with a general mean of 3.9. However, the mean of the subjects between the ages 35-40 is 3.1, which implies that they feel neither satisfied nor unsatisfied under fluorescent lighting. This preference of the said age group caused the general mean to drop.

5.1. Concluding Remarks and Recommendations for Further Research

The task for lighting researchers in various disciplines has been to determine what luminous conditions (e.g., illuminance, luminance, uniformity, luminance distribution, spectral power distribution, etc.) provide good lighting quality. This topic is too complex, because those conditions surely will not be universally valid, for lighting needs will be influenced by settings, tasks, and individual differences. And this complexity leads to pessimism about the likelihood of understanding lighting quality. It is true that the probability that one could develop a tool or measurement system that will combine photometric values into a single number, into a value that explains everything that the designer or engineer needs to know about lighting quality, is very low.

What this dissertation tries to point out is the necessity for quality research in lighting to be shifted to a base of interpretation where all relevant factors of quality are studied, and discussed; instead a base of mandatory prescriptions. That is why the writer of this dissertation has benefited from a qualitative research understanding, and the tools of behavioral sciences in data collection and evaluation.

Behavioral research can be defined as the study of how people behave or feel under different environmental conditions. It does possess the tools, descriptive studies, models, and theories, which are important for architects who want to influence certain behaviors by changing the peculiarities of the built environment. As lighting quality consist in the harmony between human activity and luminous conditions in a particular setting, to assess lighting quality requires accurate measurement of the relevant human activities, as well as accurately specified, and appropriate lighting conditions. Researches on lighting quality so far has failed because of researchers approach to lighting only from a technical background. In the case of lighting quality, multiple measures is needed because every lighting installation serves for multiple purposes, such as to satisfying requirements for visibility, task performance, social interaction, mood, safety and health, and aesthetics.

At this point it would be reasonable to inquire whether these tools and data evaluation methodologies of psychology would be appropriately adapted to the architectural context or not. Psychologists study on humans' interaction with the environment since the second half of the 20th century. Barker and Wrighl (1955) developed the theory that social settings influence human behavior and they founded a

research station in Kansas. These studies formed a new channel in psychology, which is environmental psychology, and through participations from other disciplines, such as sociology, anthropology, and history it lead today to a vast knowledge, which is a massive source to benefit from. There are a lot of studies in environmental psychology, which deals with the effects of architectural context on behaviors. Environmental psychologists believe that environment influences behavior at different levels (DeLong 2005). Immediate behavior is a function of the setting in which it occurs. They investigate how architectural styles reflect the needs and preferences of people and how different designs shape behavior. There are also some studies that deal with architectural lighting and its effects on human psychology which has been cited in this dissertation before. Environmental psychology developed several tools for measuring the effects of the environment (setting, architectural space) on behaviors. PAD, developed by Mehrabian is one of them, which is used for data collection in this dissertation.

This evaluation methodology could be improved as it will be able to determine lighting quality for spaces where daylight is also present alongside artificial lighting. The parameters related to the architectural components could be revised and enhanced in order to get consistent results in explaining the effects of lighting on form, structure, material, texture, etc. Some inconsistent results in the psychological and physiological aspects have opened up new questions and topics to study, such as the impact of lighting on the feeling of dominancy, and the impact of lighting on arousal in relation to lamb characteristics and age differences.

Lighting researchers in the past had a narrow perspective, considering the luminous environment only as a provider of visual abilities. This study has demonstrated that quality in lighting is the sum of multiple factors besides vision, and quality is achieved only if the lighting conditions fulfill all of these multiple factors.

REFERENCES

- Ambasz, E., 1976. *The Architecture of Luis Barragan*, (New York Graphic Society, Boston).
- Arnheim, R., 1977. *Art and Visual Perception, a Psychology of the Creative Eye*, (University of California Press, Berkeley).
- Barker, R.G. and Wriehl, H.F. 1955. *Midwest and its Children: The Psychological Ecology of an American Town*, (Harper and Row, New York),
- Baron, R.A. Rea, M. S. and Daniels, S. G. 1992. "Effects of Indoor Lighting (illuminance and spectral distribution) on the Performance of Cognitive Tasks and Interpersonal Behaviors: The potential Mediating Role of Positive Affect", *Motivation and Emotion*, Vol. 16, pp. 1-33.
- Baron, R.A. 1994. "The Physical Environment of Work Settings: Effects on Task Performance, Interpersonal Relations, and Job Satisfaction", *Research in Organizational Behavior*, Vol. 16, pp. 1-46.
- Bean, A.R. and Bell, R.I. 1992. "The CSP Index: A Practical Measure of Office Lighting Quality as Perceived by the Office Worker", *Lighting Research and Technology*. Vol. 24, pp. 215-225.
- Begemann, S.H.A. Aarts, M.P.J. and Tenner, A.D. 1994. "Daylight, Artificial Light, and People", paper presented at the 1994 Annual Conference of the Illuminating Engineering Society of Australia and New Zealand, Melbourne, (November 1994).
- Benya, J.R. 1988. "Practical Philosophies of Lighting Psychology", *Architectural Lighting Magazine*, November.
- Berman, S.M. Bullimore, M.A. Jacobs, R.J. Bailey, I. L. and Gandhi, N. 1994. "An Objective Measure of Discomfort Glare", *Journal of the Illuminating Engineering Society*, Vol. 23, No. 2, pp. 40-49.
- Biner, P.M. 1991. "Effects of Lighting-induced Arousal on the Magnitude of Goal Valence", *Personality and Social Psychology Bulletin*, Vol. 17, pp. 219-226.
- Blackwell, H.R. 1959. "Development and use of a Quantitative Method for Specification of Interior Illuminating Levels on the Basis of Performance Data", *Illuminating Engineering*. Vol. 54, pp. 317-353.
- Bommel, W.J.M. and Beld, G.J. 2003. *Lighting for Work: Visual and Biological Effects*, (Philips, Amsterdam).
- Boyce, P. R., 1978. "Is Equivalent Sphere Illuminance the Future?", *Lighting Research and Technology*, Vol. 10, pp. 179-183.

- Boyce, P.R., 1981. *Human Factors in Lighting*, (Applied Science Publishers, London).
- Boyce, P.R. Beckstead, J. And Strobel, R. 1997. "Lighting the Graveyard-shift: The Influence of a Daylight-simulating Skylight on the Task Performance and Mood of Night-shift Workers", *Lighting Research and Technology*, Vol. 29, No. 3, pp. 105-134
- Boyce, P. R. Hunter, C.M. and Carter C.B.. 2001. "Perceptions of Full-spectrum, Polarized Lighting", IESNA Annual Conference Technical Papers, New York, IESNA, New York, pp. 323-346.
- Brass, J. 1982. "Discarding ESI in Favor of Brightness Contrast Engineering: A 'Wide Angle' View", *Lighting Design and Applications*. Vol. 12, No. 11, pp. 30-34.
- Brainard, G.C. 2002. "Photoreception for Regulation of Melatonin and the Circadian System in Humans", Fifth International LRO lighting Research Symposium, Orlando, (3-5 November 2002).
- British Lighting Council, 1962. *Lighting and Productivity in Factories and Offices*, (British Lighting Council, London).
- Carr, S., 1973. *City Signs and Lights*, (Boston Redevelopment Authority and U.S. Department of Housing and Urban Development, Boston).
- Choi, T.Y. and Eboch, K. 1998. "The TQM Paradox: Relations among TQM Practices, Plant Performance, and Customer Satisfaction", *Journal of Operations Management*. Vol. 17, pp. 59-75.
- CIBSE, 1994. *Lighting for Museum and Art Galleries*, (Mc Crimmon, London)
- Collins, B.L. 1990. "Evaluation of the Role of Luminance Distributions in Occupant Response to Lighting", CIBSE National Lighting Conference, Cambridge, (8-11 April 1990).
- Collins, B.L. Fisher, W.S. Gillette, G.L. and Marans, R.W. 1991. "Second Level Postoccupancy Evaluation Analysis", *Journal of the Illuminating Engineering Society*, Vol. 19, pp. 21-44
- Costa, G. Ghirlanda, G. Minors, D.S. and Waterhouse, J.M. 1993. "Effect of Bright Light on Tolerance to Night Work", *Scandinavian Journal of Work, Environment, and Health*, Vol. 19, pp. 414-420.
- Crosby, P.B., 1980. *Quality is Free*, (McGraw-Hill, New York).
- Cullen, J., 1986. *The Lighting Handbook*, (Johnson Editions, London).
- Delong, A., 2005. *Social and Behavioral Sciences*, (University of Tennessee Publications).
- Deming, W.E., 1986. *Out of the Crisis*, (MIT Press, Cambridge).

- Diggs, D.M. 1933. "Light, the Cities Great Protector", *American City*. Vol. 48.
- Durmisevic, S. and Sarıyıldız, S. 2001. "A Systematic Quality Assessment of Underground Spaces- Public Transport Stations", *Cities*. Vol. 18, pp. 13-23.
- Egan, M.D., 1983. *Concepts in Architectural Lighting*, (Mc Graw Hill, New York).
- Erco 1999. "Doppelfokus", *Lichtbericht*, Vol. 60, pp. 22-23.
- Eysenck, H. J., 1990. "Biological Dimensions of Personality", in *Handbook of Personality: Theory and Research*, edited by L. A. Pervin (Guilford, New York), pp. 244-276.
- Fleischer, S. Krueger, H. and Schierz, C. 2001. "Effect of Brightness Distribution and Light Colours on Office Staff", paper presented at the 9th European Lighting Conference, Reykjavik, (18-20 June 2001).
- Flynn, J.E. Spencer, T.J. Martyniuk, O. and Hendrick, C., 1992. "Interim Study of Procedures for Investigating the Effect of Light on Impression and Behavior", in *Selected Papers on Architectural Lighting*, edited by M.S Rea. and B.J. Thomson, (SPIE, Washington).
- Fox, J., 1993. *Quality Through Design: The Key to Successful Product Delivery*, (McGraw & Hill, London).
- Fördergemeinschaft Gutes Licht, 2002. "Lighting with Artificial Light", *Information on Lighting Applications*. Vol. 1.
- Fraser, T. and Banks, A., 2004. *Designer's Color Manual: The Complete Guide to Color Theory and Application*, (Chronicle Books, New York).
- Gabosh, K., 1994. *A Structured Introduction to Longwave Ultra-violet Examination*, (London).
- Ganslandt, R. 1995. "Lighting Design between Art and Science", *Lichtbericht*. Vol. 52, p. 21.
- Ganslandt, R. and Hofmann, H., 1992. *Handbook of Lighting Design*, (Maack, Lüdenscheid)
- Gay, L.R. and Airasian, P., 1999. *Educational Research: Competencies for Analysis and Application*, (Merrill, New Jersey).
- Gifford, R Hine, D.W. and Veitch, J.A. 1997. "Meta Analysis for Environment-Behavior Research, Illuminated with a Study of Lighting Level Effects on Office Task Performance", in *Advances in Environment, Behavior, and Design*, edited by G.T. Moore and R.W. Marans (Plenum, New York).

- Gligor, V. 2003. "Does the CEN Standard for Interior Lighting Reflect the Principles of Lighting Quality?", paper presented at the Seminar on Illuminating Engineering: Productive office Lighting, (10 January 2003).
- Gordon, G. 1987. "Using Brightness to Create Lighting Effects", *Architectural Lighting Magazine*. March.
- Günaydin, H.M., 2003. "Toplam Kalite Yönetimi", Notes of the Lecture of Total Quality Management in İzmir Institute of Technology.
- Guth S.K. 1963. "A Method for Evaluation of Discomfort Glare", *Journal of the Illuminating Engineering Society*. May, pp. 351-364.
- Guth, S.K. 1966. "Computing Visual Comfort Ratings for a Specific Interior Lighting Installation", *Illuminating Engineering*. Vol. 61.
- Harrison, W. Haas, O.F. and Reid, K., 1930. *Street Lighting Practice*, (McGraw Hill, New York).
- Heritage Collection Council 1998. "Light and Ultraviolet Radiation", *Recollections: Caring for Collections Across Australlia- Damage and Decay*, p. 12.
- Herst, D.J. and Ngai, P.Y. 1978. "A Ranking System Based on Visual Performance Potential and Visual Comfort", *Lighting Design + Application*. Vol. 8, No. 3, pp. 45-52.
- Hill, M.A. 1992. "Light, Circadian Rhythms, and Mood Disorders: A Review", *Annals of Clinical Psychiatry*, Vol. 4, pp. 131-146.
- Hopkinson, R.G., 1969. *The Lighting of Buildings*, (Praeger, New York).
- Hopkinson, R.G. and Longmore J. 1959. "Attention and Distraction in the Lighting of Work-places", *Ergonomics*, Vol. 2, 1959, pp. 321-334.
- Horst, R.L. Silverman, E.B. Kershner, R.L. Mahaffey, D.L. and Parris, H.L. 1988. "Research Study on the Effects of Illumination on Performance of Control Room Tasks", IEEE Fourth Conference on Human Factors and Power Plants, Monterey,(June 1988), pp. 238-246.
- Hughes, P.C. and McNelis, J.F. 1978. "Lighting, Productivity, and the Work Environment", *Lighting Design + Application*, Vol. 8, No. 12, pp. 32-39.
- IESNA,1981. *Lighting Handbook: 1981 Application Volume*, edited by J.E. Kaufmann and J.F. Christensen (IESNA, New York).
- IESNA, 1987. *IESNA Lighting Handbook*, (IESNA, New York).
- IESNA, 2000. *Quality of the Visual Environment*, (IESNA, New York).

- Inui, M. and Miyata, T. 1973. "Spaciousness in Interiors", *Lighting Research and Technology*, Vol. 5, No. 2, pp. 103-111.
- Inui, M. Nakamura, Y. and Lee, J.S. 1989. "Towards Better Office Lighting", Proceedings of the VI Lux Europa, Budapest, (October 1989), Hungarian Society of Illuminating Engineering, Budapest, pp. 41-50.
- Inui, M. and Nakamura, Y. 1991. "The Psychological Effect of the Luminance Distribution on Offices", Proceedings of the CIE 22nd Session, Melbourne, (29-30 July 1991).
- Jones, B. 1983. "Structures in Light", *Light*, Vol. 5, pp.23-27.
- Julian, W.G. 1995. "Quality of Lighting", CIE Conference, Delhi, (1-8 November 1995).
- Kampf, J., 2005. "Design for Success: Lighting Quality", presentation notes, (11 May 2005).
- Kaufmann, J.E., 1966. "Museum and Art Galleries", in IES Lighting Handbook: The Standard Lighting Guide, (IES, New York, 1966).
- Kay, J.D., 1996. *The Lighting of Buildings*, (Praeger, New York).
- Kaye, S.M. 1988. "Variations in the Luminous and Sonic Environment: Proofreading and Visual Search Effects; Mood States and Frustration Tolerance Aftereffects", New York Lighting Research Institute.
- Kelly, J.J. 2003. "The Challenges Facing National Weather Service Shift Workers", National Report for the Weather Service National Oceanic and Atmospheric Administration U.S. Department of Commerce.
- Kimmel, P.S. and Blasdel, H.G. 1973. "Multidimensional Scaling of Luminous Environment", *Journal of the Illuminating Engineering Society*, Vol. 2, pp. 113-120.
- Kinkeldey, R. Loe, D. and Stockmar, A.W. 1990. "Subjective and Objective Illumination Data Collection in Offices", CIBSE National Lighting Conference, Cambridge, (8-11 April 1990).
- Knez, I. 1995. "Effects of Indoor Lighting on Mood and Cognition", *Journal of Environmental Psychology*, Vol. 15, pp. 39-51.
- Knez, I. 1997. "Changes in Females' and Males' Positive and Negative Moods As a Result of Variations in CCT, CRI and Illuminance Levels", *Right Light*, Vol. 4., pp. 149-154.
- Kruithof, A.A. 1941. "Tubular Luminescence Lamps for General Illumination", *Philips Technology Review*. Vol. 6.

- Kutlu, H.G., 2000. *The Peculiarities of Light as a Quality in Architecture*, Master Thesis, İzmir Institute of Technology, İzmir, Advisor: Asst. Prof. Dr. Özlem Erkarşlan.
- Kuller, R. Laike, T. 1998. "The Impact of Flicker from Fluorescent Lighting on Well-being, Performance and Physiological Arousal", *Ergonomics*, Vol. 41, No. 4, pp. 433-447.
- Lam, W.C., 1992. *Perception and Lighting as Formgivers for Architecture*, (Van Nostrand Reinhold, New York).
- Laurentine, C. Berrutto, V. and Fontoyont, M. 2000. "Effect of the Thermal Conditions and Light Source Type Visual Comfort Appraisal", *Lighting Research and Technology*. Vol. 32, No. 4, pp. 223-233.
- Lechner, N., 1991. *Heating, Cooling, Lighting- Design Methods for Architects*, (John Wiley & Sons, New York).
- Leslie, R. P. and Hartleb, S. B. 1990. "Human Response and Variability in the Luminous Environment", Proceedings of the CIBSE National Lighting Conference, Cambridge, (8-11 April 1990).
- Levy, A.W.1978. "The CIE Visual Performance System", *Lighting Research and Technology*. Vol. 10, pp. 19-27.
- Loe, D.L. Mansfield, K.P. and Rowlands, E. 1991. "Light Patterns and Their Relevance to Spatial Appearance and the Quality of the Lit Environment", Proceedings of the CIE 22nd Session, Melbourne, (29-30 July 1991).
- Loe, D.L. Roelands, E. and Watson, F. 1982. "Preferred Lighting Conditions for the Display of Oil and Watercolor Paintings", *Lighting Research and Technology*. Vol. 14.
- Lynch, K., 1960. *The Image of the City*, (MIT Press, London).
- Marsteller, J. 1987. "A Philosophy of Light: Richard Kelly's Design Elements", *Interior Design*. Vol. 1, pp. 21-26.
- Mattiello, M.L.F. 2004. "Color and Light in Architecture", Proceedings of AIC 2004 Color and Paint Interim Meeting of the International Color Association, Porto Alegre, Brazil, (2-5 November 2004), pp. 190-193.
- Mehrabian, A. 1976. "Three Dimensions of Emotional Reaction", *Psychology Today*. Vol. 10, No. 3, pp. 57-61.
- Michel, L., 1996. *Light: The Shape of the Space- Designing with Space and Light*, edited by J. Griffin (Van Nostrand Reinhold, New York).
- Miller, N. 1994. "Pilot Study Reveals Quality Results", *Lighting Design and Application*, Vol. 24, No. 3, pp. 19-21.

- Millet, M.S., 1996. *Light Revealing Architecture*, edited by C. M. Nessler (Van Nostrand Reinhold, New York).
- Nelson, T.M. Hopkins, G.W. and Nilsson, T.H. 1983. "Steps toward Convergence of Optimal Human and Energy Effectiveness: Interactions of Indoor Environmental Factors and their Effects on Human Performance, Comfort, and Mood", Report for the Alberta Environmental Research Trust, Edmonton.
- Nelson, T. M. Nilsson, T. H. and Johnson, M. 1984. "Interaction of temperature, Illuminance and Apparent Time on Sedentary Work Fatigue", *Ergonomics*, Vol. 27, pp. 89-101.
- O'Donell, B. Raitelli, M. and Kirschbaum, C. 1999. "Lighting Evaluation at Workplaces in Subtropical Regions", poster presented at CIE Conference, Warsaw, (24-30 June 1999).
- Ooyen, M.H.F. van Weijgert, J.C.A. van de and Begemann, S.H.A. 1986. "Luminance Distribution as a Basis for Office Lighting Design", Proceedings of the CIBSE National Lighting Conference, Nottingham, UK: Chartered Institute of Building Services Engineers, London, pp. 103-108.
- Pavlogeorgatos, G. 2003. "Environmental Parameters in Museums", *Building and Environment*. Vol. 38, pp. 1452-1467.
- Philips, D., 1989. "Light Sources", in *Lighting in Architectural Design*, (Mc Graw Hill Company, New York).
- Rea, M.S., 1993. *Lighting Handbook*, (IESNA, New York)
- Rea, M.S. and Ouellette, M.J. 1991. "Relative Visual Performance: A Basis for Application", *Lighting Research and Technology*. Vol. 23, pp. 135-144.
- Rowlands, E. Loe, D.I. Macintosh, R.M. and Mansfield, K.P. 1985. "Lighting Adequacy and Quality in Office Interiors by Consideration of Subjective Assessment and Physical Measurement", *CIE Journal*, Vol. 4, No. 1, pp. 23-37.
- Rub, T. 1986. "Lighting Up the Town: Architectural Illumination in the Jazz Age", *Architectural Record*, August.
- Saunders, J.E. 1969. "The Role of the Level and Diversity of Horizontal Illumination in an Appraisal of a Simple Office Task", *Lighting Research and Technology*. Vol. 1, pp. 37-46.
- Scheerbart, P., 1971. "Glass Architecture", in *Programmes and Manifestoes on 20th Century Architecture*, edited by U. Conrads (MIT Press, London).
- Scuello, M. Abramov, I. Gordon, J. and Weintraub, S. 2004. "Museum Lighting: Optimizing the Illuminant", *Color Research and Application*. Vol. 29, pp. 121-127.

- Shaw, K. 1995. "Museum and Gallery Lighting", K. Shaw's Website, 2003. <http://www.kevan-shaw.com/articles/mus-gall/museums/Museum-Galleries.html>
- Steelcase 1999. "Seeing the Difference: The Importance of Quality Lighting in the Workplace", *Workplace Issues: One in a Series*, Vol.12, pp. 1-16.
- Stone, P.T. Clarke, A.M. and Slater, A.I. 1980. "The Effect of Task Contrast on Visual Performance and Visual Fatigue at a Constant Illuminance", *Lighting Research and Technology*. Vol. 12, pp. 144-159.
- Stone, P.T. 1992. "Fluorescent Lighting and Health", *Lighting Research and Technology*, Vol. 24, pp. 55-61.
- Swinney, G.N. 1999. "Gas Lighting in British Museums and Galleries, with Particular Reference to the Edinburgh Museum of Science and Art", *Museum Management and Curatorship*. Vol. 18.
- Taylor, L.H. Sucov, E.V. and Schaffer, D.H. 1975. "Office Lighting and Performance", *Lighting Design and Application*, Vol. 5, No. 5, pp. 30-36.
- Taylor, L.H. and Sucov, E.V. 1974. "The Movement of People toward Lights", *Journal of the Illuminating Engineering Society*, Vol. 3, No. 4, pp. 237-241.
- The University Of Iowa Campus Lighting Committee, 1999. *Campus Lighting Strategy*, (The University of Iowa Press, Iowa).
- Theodore, T.J. and Bradshaw, J. 1986. "Light and Form", *Architectural Lighting*. Vol. 68, pp. 41-43.
- Thomsen, C.W., 1994. "Crystalline Architecture and Organic Sculpture", in *Visionary Architecture*, edited by S. Haviland (Prestel, New York).
- Tien J. M., 1979. *Street Lighting Projects*, (National Institute of Law Enforcement and Criminal Justice, Washington).
- Torrez, L., 2003. "Prominent Models of Visual Performance", University of Central Florida's Website, 2003. <http://pegasus.cc.ucf.edu>
- Trauthwein, C., "Back to Basics: Daylighting", *Architectural Lighting Magazine*, Vol 20, pp. 33-38.
- Tregenza, P.R. Romaya, S.M. Dawe, S.P. Heap, L.J. and Tuck, B. 1974. "Consistency and Variation in Preferences for Office Lighting", *Lighting Research and Technology*, Vol. 6, No. 4, pp. 205-211.
- Tullmann, M.L. 2000. "Dynamic Full Spectrum Digital Lighting of Retail Displays Positively Affects Consumer Behavior", <http://www.colorkinetics.com/support/whitepapers/retailwhitepaper.pdf>

- Veitch, J.A. and Gifford, R. 1996. "Assessing Beliefs about Lighting Effects on Health, Performance, Mood, and Social Behavior", *Environment and Behavior*, Vol. 28, pp. 446-470.
- Veitch, J.A. and Newsham, G.R. 2000. "Preferred Luminous Conditions in Open-plan Offices", *Lighting Research and Technology*, Vol. 32, No. 4, pp. 199-212.
- Veitch, J.A. and Newsham, G.R. 2004. "Determinants of Lighting Quality: State of Science", IESNA's Website, 2004. <http://www.iesna.org>
- Von Meiss, P., 1990. *Elements of Architecture*, (E&FN Spon, London).
- Wagner, W.F. 1985. "Round Table: Lighting-an Art Supported by a Technology", *Architectural Record*, Vol. 173, No. 4, pp. 156-163.
- Waldram, J.M. 1954. "Studies in Interior Lighting", Transactions of the Illuminating Engineering Society, Vol. 19, No. 4.
- WEB_1, 2002. Tristate's Website, 2002. <http://tristate.apogee.net/>
- WEB_2, 2005. Georgia State University's Website, 2005.
<http://www2.gsu.edu/~mstsw/courses/it7000/papers/the1.htm>
- WEB_3, 2006. University of Miami School of Architecture's Website, 2006.
<http://intranet.arc.miami.edu/rjohn/images/HadrianicArchitecture/Dome%20view%20Pantheon.jpg>
- WEB_4, 2003. CIE's Website, 2003. <http://www.cie.co.at/cie/>
- WEB_5, 2005. Lenovo's Website, 2005.
<http://www.pc.ibm.com/ww/healthycomputing/vdt19d.html>
- WEB_6, 2006. Topbulb's Website, 2006. <http://www.topbulb.com/find/cr1.asp>
- WEB_7, 2004. Light Forum's Website, 2004.
<http://www.lightforum.com/design/ALM026.html>
- WEB_8, 2004. UE's Website, 2004. http://www.ranknfile-ue.org/stwd_fatigueshift.html
- WEB_9, 2006. National Headache Foundation's Website, 2006.
http://www.headaches.org/consumer/topicsheets/envir_physical.html
- WEB_10, 2006. WMO UV Radiation's Website, 2006.
<http://uv.colorado.edu/what.html>
- WEB_11, 2003. Jlis's Website, 2003.
<http://www.city.yokosuka.kanagawa.jp/speed/mypage/m-imajo/jlissemnar/museum/museum-e.html>

- White, F.O. and Wolf, F. J. 1995. "Is This Ice Cream American?", *Administration & Society*. Vol. 28.
- Wilkins, A.J. Clark, C. 1990. "Modulation of Light from Fluorescent Lamps", *Lighting Research and Technology*, Vol. 22, pp. 103-109.
- Wilkins, A.J. 1993. "Health and Efficiency in Lighting Practice", *Energy*, Vol 18, pp. 123-129.
- Yearout, R. and Konz, S. 1989. "Visual Display Unit Workstation Lighting", *International Journal of Industrial Ergonomics*, Vol. 3, pp. 265-273.

APPENDIX A

PHOTOMETRIC RESULTS FOR RECESSED FLUORESCENT LIGHTING SYSTEM

3FFilippi 2906 L 324x18 SPA / Luminaire Data Sheet



Luminous emittance 1:

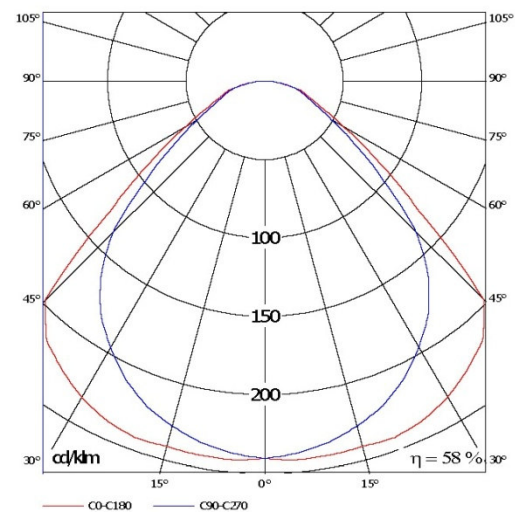

Luminaire classification according to CIE: 100
CIE flux code: 57 88 97 100 58

ILLUMINOTECHNICAL CHARACTERISTICS

Luminous efficiency >58%.
Direct symmetrical distribution.
UGR <18 (EN 12464-1).

MECHANICAL CHARACTERISTICS

SPA transparent methacrylate flat diffuser, plurilenticular, anti-glare, internal or external prismatic depending on environment's cleaning, injection moulded, resting on the structure, without frame.
Housing in hot galvanized steel, painted in white polyester.
Dimensions: 596x596 mm, height 84 mm. Weight 5.25 kg.
IP44 protection degree exposed part.
Installation also on normally inflammable surfaces. - F -
Resistance to glow wire 650°C.

ELECTRICAL CHARACTERISTICS

EEL B2 wiring with starter with low loss ballast, 230V-50Hz, power factor correction, fuse, class I.
ENEC.

APPLICATIONS

In environments requiring protection, lamp's shielding and simplified cleaning.

Summary

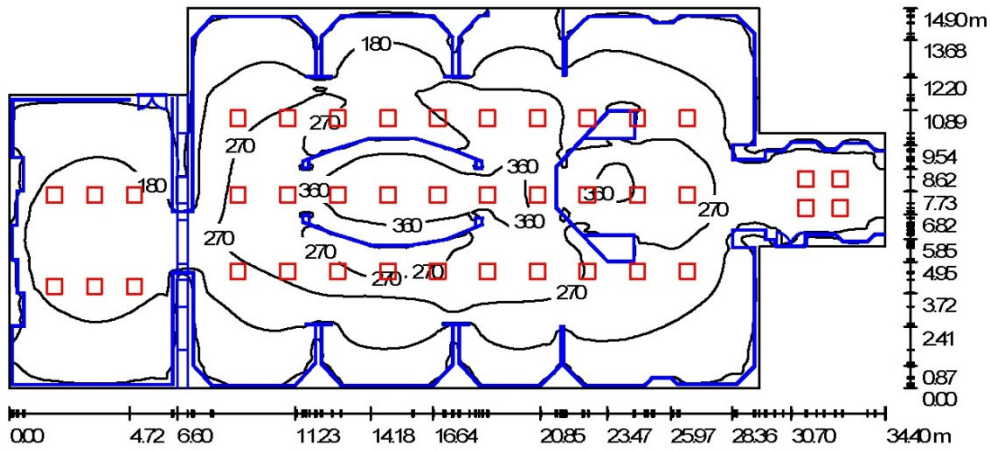

Height of Room: 6.500 m

Values in Lux, Scale 1:246

Surface	ρ [%]	E_{av} [lx]	E_{min} [lx]	E_{max} [lx]	u_0
Workplane	/	211	15	420	0.07
Floor	68	195	6.10	398	0.03

Workplane:

Height: 0.760 m
Grid: 128 x 128 Points

Luminaire Parts List

No.	Pieces	Designation (Correction Factor)	Φ [lm]	P [W]
1	40	3FFilippi 2906 L 324x18 SPA (1.000)	5400	86
			total: 216000	3440

Specific connected load: $7.87 \text{ W/m}^2 = 3.73 \text{ W/m}^2/100 \text{ lx}$ (Area: 436.93 m^2)

Calculation surfaces (results overview)

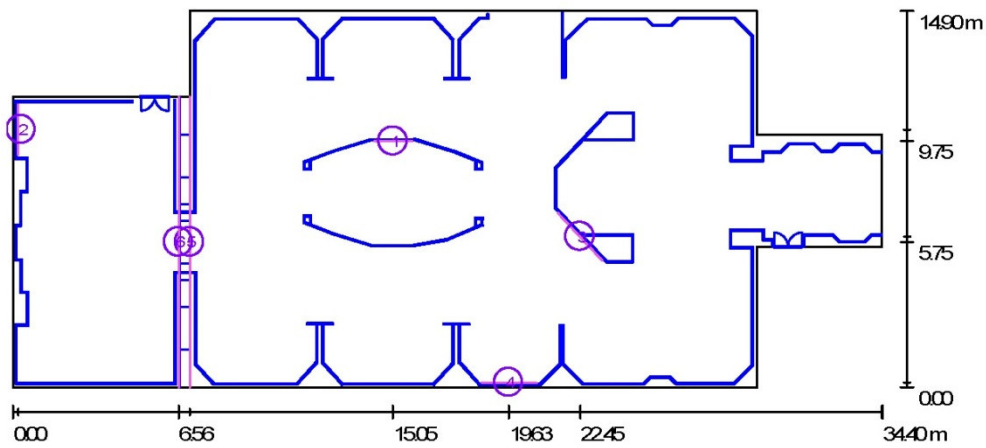

Scale 1 : 246

Calculation Surface List

No.	Designation	Type	Grid	E_{av} [lx]	E_{min} [lx]	E_{max} [lx]	u_0	E_{min} / E_{max}
1	Calculation Surface 1	perpendicular	16 x 16	251	241	293	0.96	0.82
2	Calculation Surface 2	perpendicular	8 x 8	100	88	113	0.88	0.78
3	Calculation Surface 3	perpendicular	32 x 32	180	153	234	0.85	0.65
4	Calculation Surface 4	perpendicular	16 x 16	153	141	169	0.92	0.83
5	Calculation Surface 5	perpendicular	128 x 64	99	4.29	226	0.04	0.02
6	Calculation Surface 6	perpendicular	128 x 64	76	3.20	192	0.04	0.02

Summary of Results

Type	Quantity	Average [lx]	Min [lx]	Max [lx]	u_0	E_{min} / E_{max}
perpendicular	6	99	3.20	293	0.03	0.01

Workplane / Isolines (E)

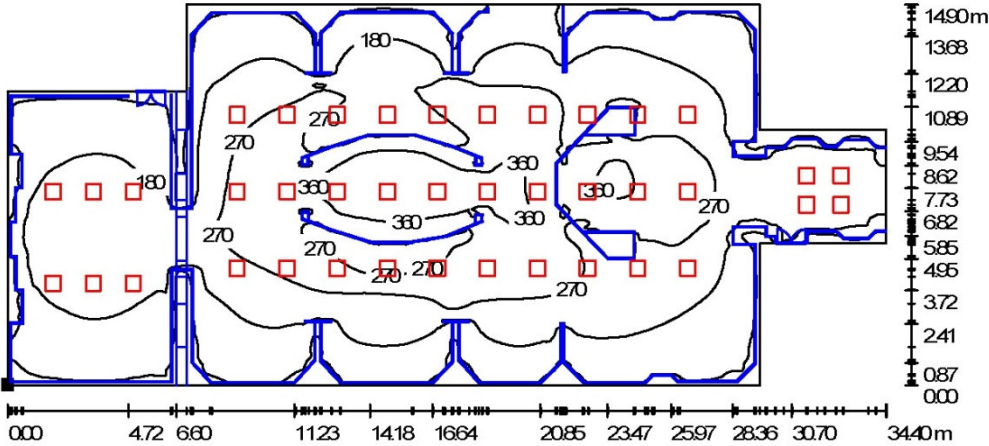

Values in Lux, Scale 1 : 246

Position of surface in room:
Marked point:
(0.000 m, 0.000 m, 0.760 m)



Grid: 128 x 128 Points

E_{av} [lx]	E_{min} [lx]	E_{max} [lx]	u_0	E_{min} / E_{max}
211	15	420	0.07	0.03

Workplane / Greyscale (E)

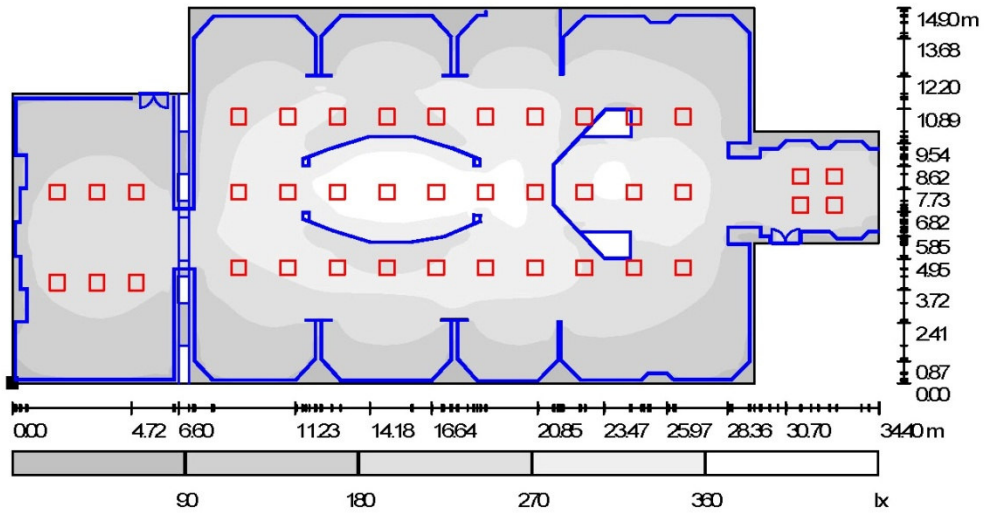

Scale 1 : 246

Position of surface in room:
Marked point:
(0.000 m, 0.000 m, 0.760 m)



Grid: 128 x 128 Points

E_{av} [lx]	E_{min} [lx]	E_{max} [lx]	$u0$	E_{min} / E_{max}
211	15	420	0.07	0.03

Workplane / Value Chart (E)

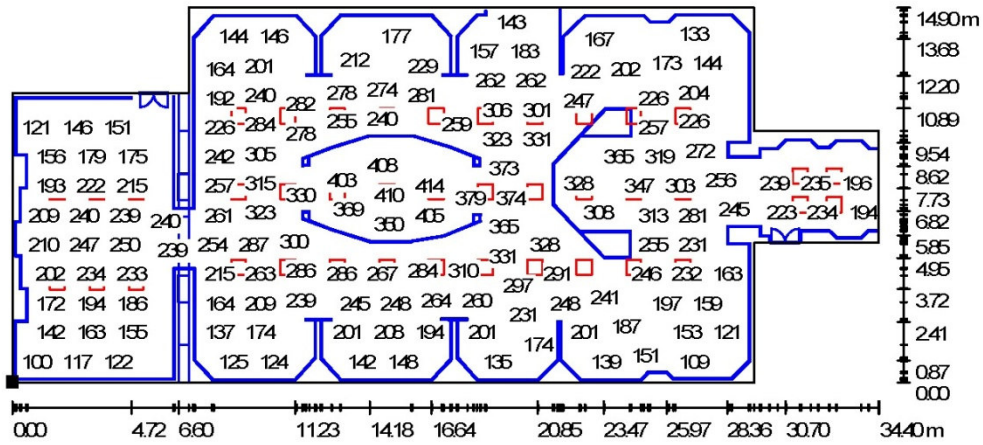

Values in Lux, Scale 1 : 246

Not all calculated values could be displayed.

Position of surface in room:
Marked point:
(0.000 m, 0.000 m, 0.760 m)



Grid: 128 x 128 Points

E_{av} [lx]	E_{min} [lx]	E_{max} [lx]	u_0	E_{min} / E_{max}
211	15	420	0.07	0.03

Calculation Surface 1 / Isolines

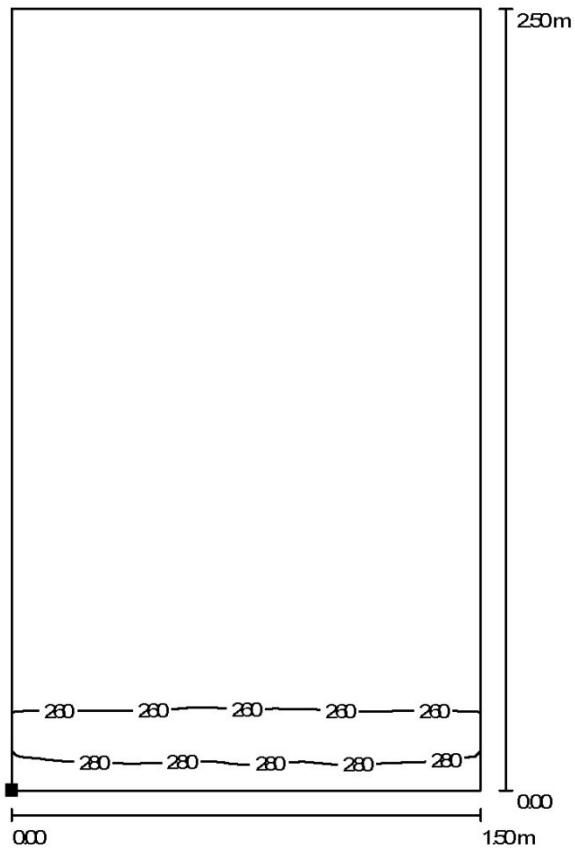

Position of surface in room:
Marked point:
(14.300 m, 9.750 m, 0.000 m)

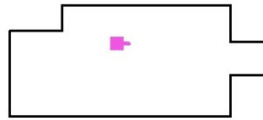

Values in Lux, Scale 1 : 20

Grid: 16 x 16 Points

E_{av} [lx]
251

E_{min} [lx]
241

E_{max} [lx]
293

$u0$
0.96

E_{min} / E_{max}
0.82

Calculation Surface 1 / Greyscale

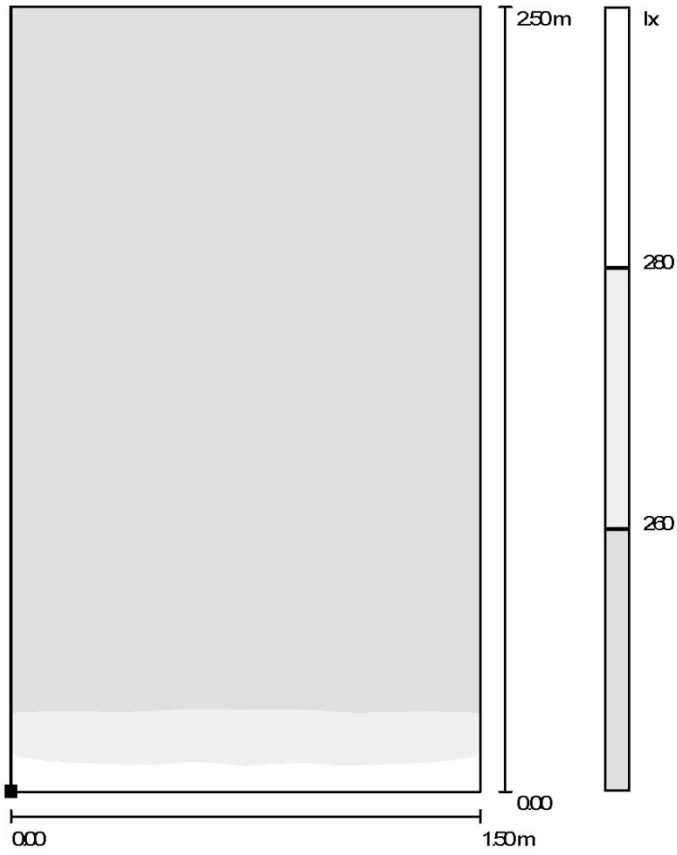

Position of surface in room:
 Marked point:
 (14.300 m, 9.750 m, 0.000 m)

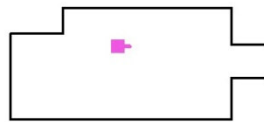

Scale 1 : 20

Grid: 16 x 16 Points

E_{av} [lx]
251

E_{min} [lx]
241

E_{max} [lx]
293

$u0$
0.96

E_{min} / E_{max}
0.82

Calculation Surface 1 / Value Chart

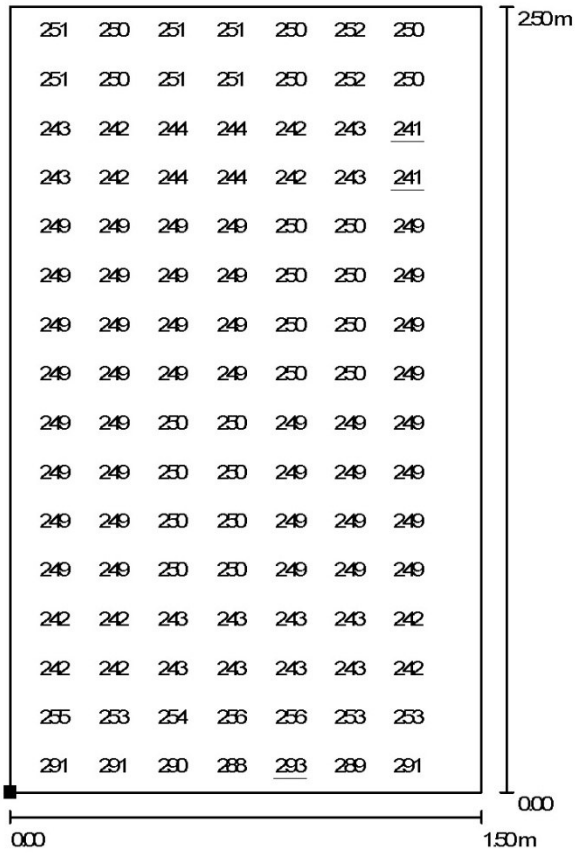

Values in Lux, Scale 1 : 20

Not all calculated values could be displayed.

Position of surface in room:
Marked point:
(14.300 m, 9.750 m, 0.000 m)

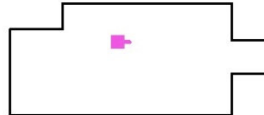

Grid: 16 x 16 Points

E_{av} [lx]	E_{min} [lx]	E_{max} [lx]	u0	E_{min} / E_{max}
251	241	293	0.96	0.82

Calculation Surface 2 / Isolines

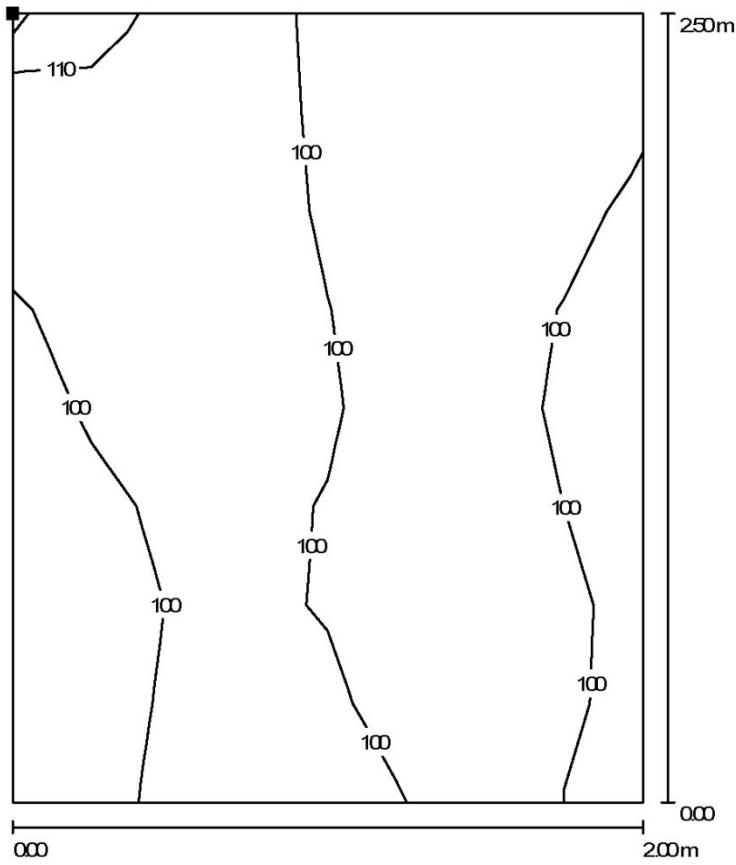

Position of surface in room:
 Marked point:
 (0.205 m, 9.200 m, 2.500 m)

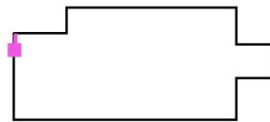

Values in Lux, Scale 1 : 20

Grid: 8 x 8 Points

E_{av} [lx]	E_{min} [lx]	E_{max} [lx]	u_0	E_{min} / E_{max}
100	88	113	0.88	0.78

Calculation Surface 2 / Greyscale

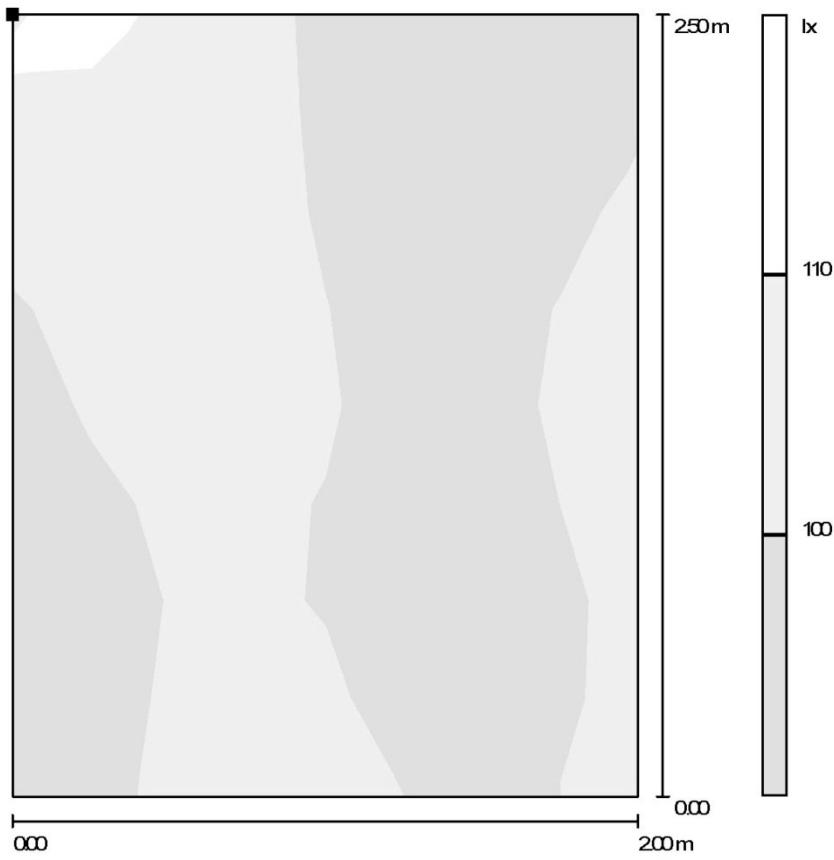

Position of surface in room:
 Marked point:
 (0.205 m, 9.200 m, 2.500 m)

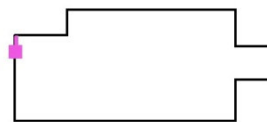

Scale 1 : 20

Grid: 8 x 8 Points

E_{av} [lx]	E_{min} [lx]	E_{max} [lx]	$u0$	E_{min} / E_{max}
100	88	113	0.88	0.78

Calculation Surface 2 / Value Chart

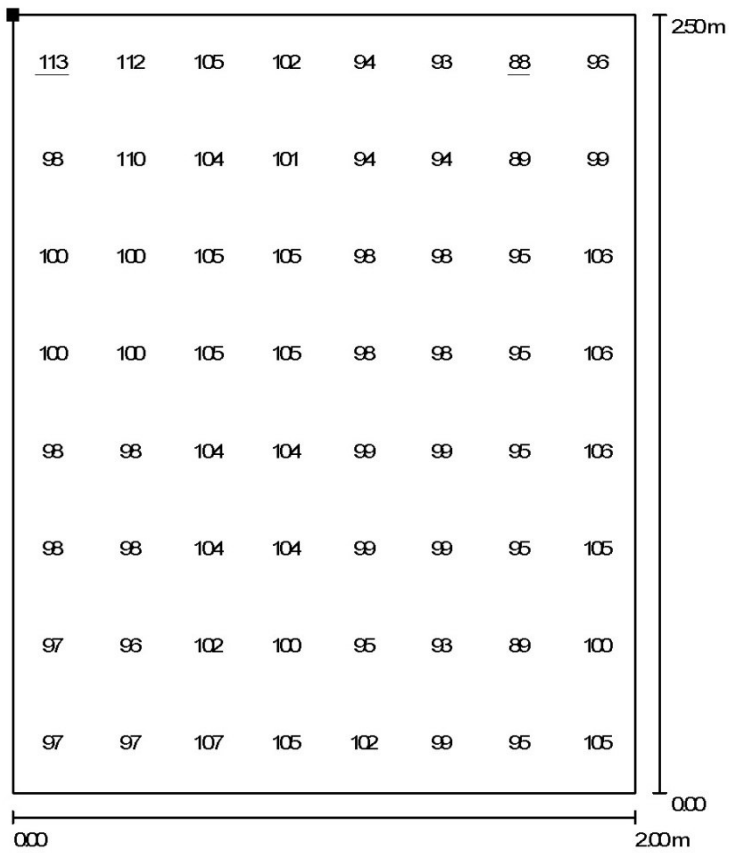

Values in Lux, Scale 1 : 20

Position of surface in room:
Marked point:
(0.205 m, 9.200 m, 2.500 m)



Grid: 8 x 8 Points

E_{av} [lx]
100

E_{min} [lx]
88

E_{max} [lx]
113

$u0$
0.88

E_{min} / E_{max}
0.78

Calculation Surface 3 / Isolines

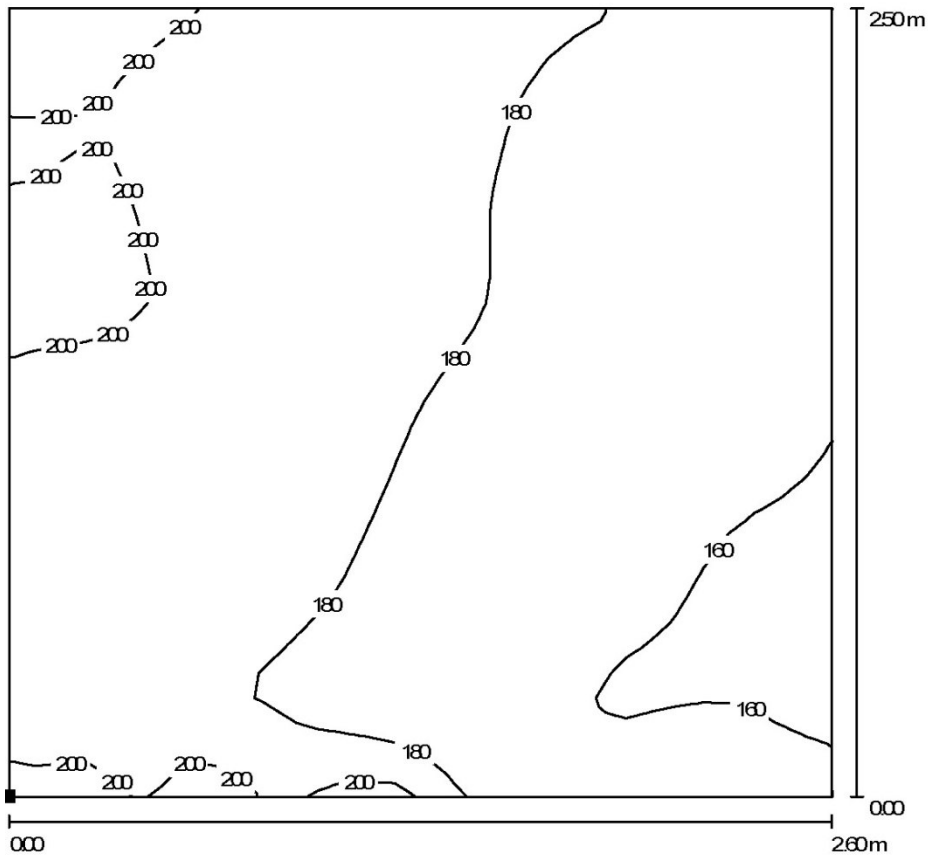

Values in Lux, Scale 1 : 20

Position of surface in room:
Marked point:
(21.558 m, 6.911 m, 0.000 m)



Grid: 32 x 32 Points

E_{av} [lx]	E_{min} [lx]	E_{max} [lx]	$u0$	E_{min} / E_{max}
180	153	234	0.85	0.65

Calculation Surface 3 / Greyscale

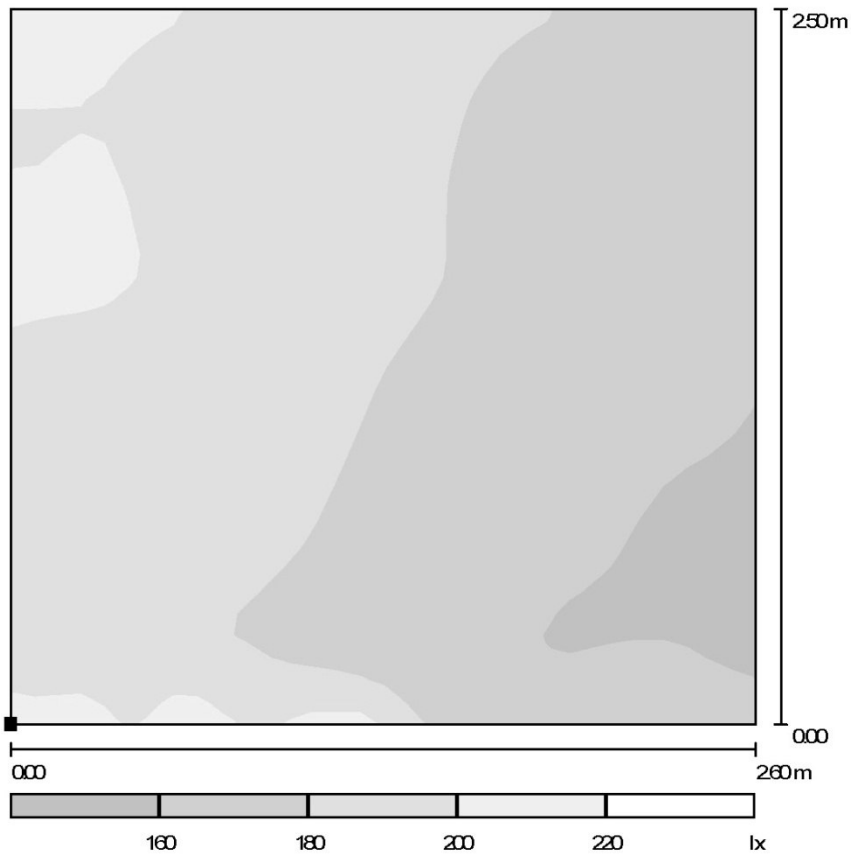

Position of surface in room:
 Marked point:
 (21.558 m, 6.911 m, 0.000 m)

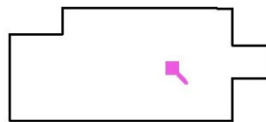

Scale 1 : 22

Grid: 32 x 32 Points

E_{av} [lx]	E_{min} [lx]	E_{max} [lx]	$u0$	E_{min} / E_{max}
180	153	234	0.85	0.65

Calculation Surface 3 / Value Chart

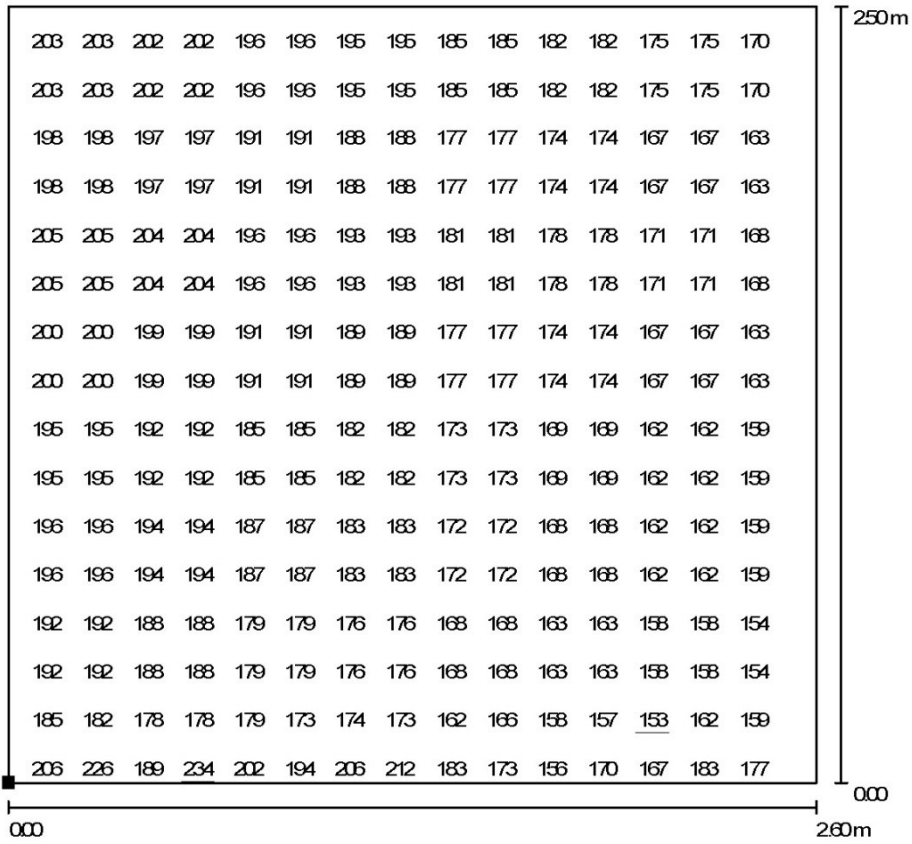

Values in Lux, Scale 1 : 20

Not all calculated values could be displayed.

Position of surface in room:
Marked point:
(21.558 m, 6.911 m, 0.000 m)

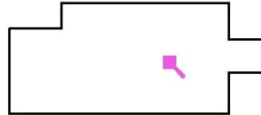

Grid: 32 x 32 Points

E_{av} [lx]
180

E_{min} [lx]
153

E_{max} [lx]
234

$u0$
0.85

E_{min} / E_{max}
0.65

Calculation Surface 4 / Isolines

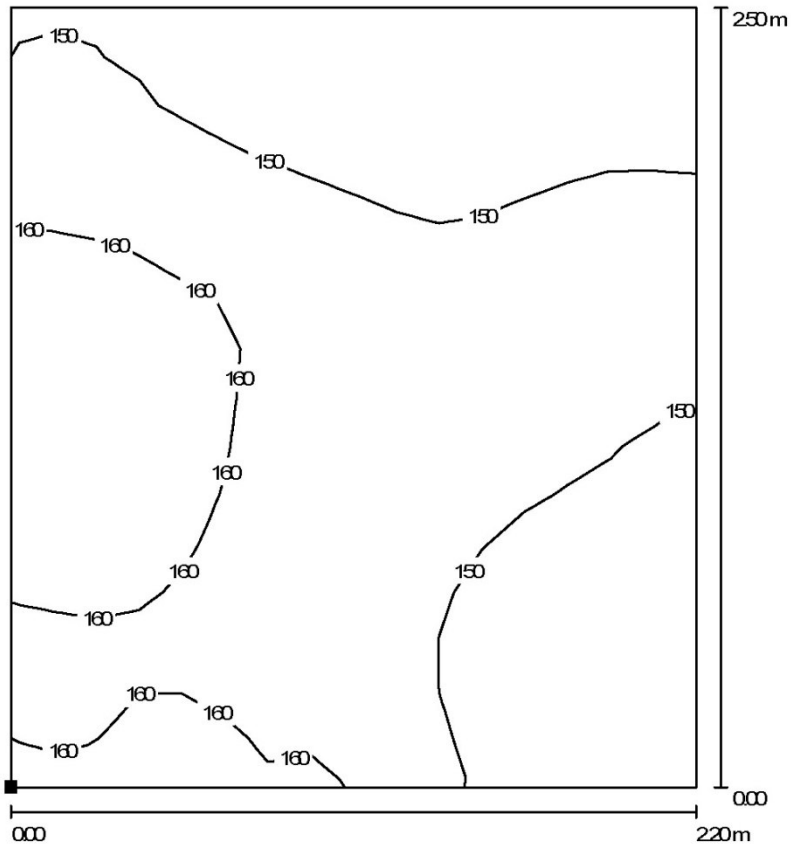

Values in Lux, Scale 1 : 20

Position of surface in room:
Marked point:
(20.730 m, 0.175 m, 0.000 m)



Grid: 16 x 16 Points

E_{av} [lx]	E_{min} [lx]	E_{max} [lx]	u_0	E_{min} / E_{max}
153	141	169	0.92	0.83

Calculation Surface 4 / Greyscale

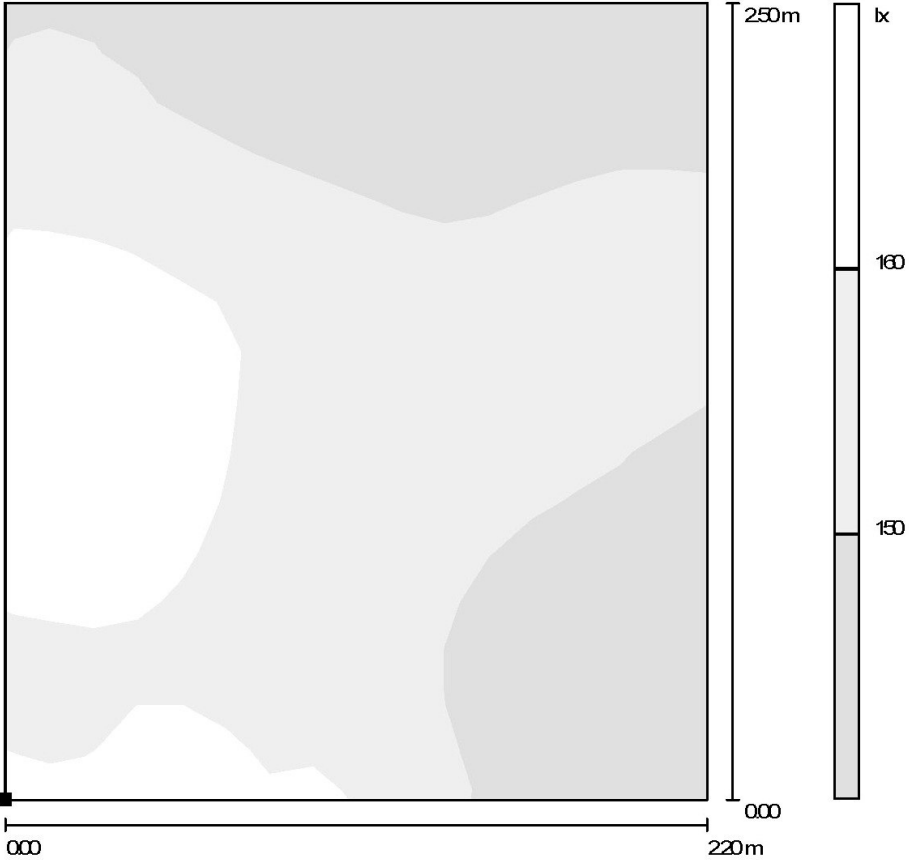

Position of surface in room:
 Marked point:
 (20.730 m, 0.175 m, 0.000 m)



Scale 1 : 20

Grid: 16 x 16 Points

E_{av} [lx]	E_{min} [lx]	E_{max} [lx]	$u0$	E_{min} / E_{max}
153	141	169	0.92	0.83

Calculation Surface 4 / Value Chart

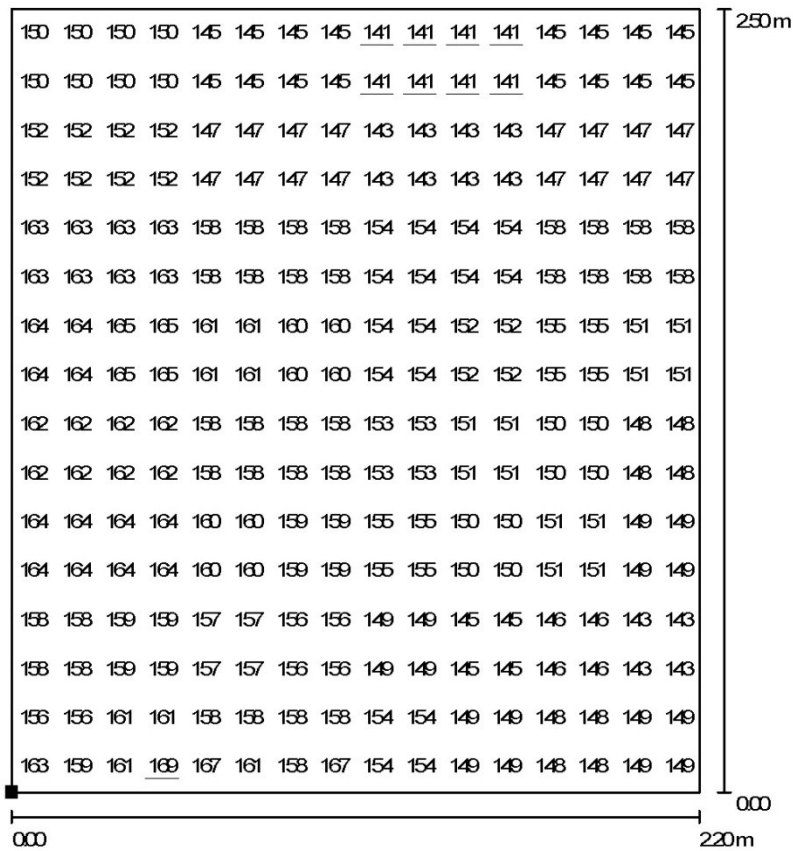

Values in Lux, Scale 1 : 20

Position of surface in room:
Marked point:
(20.730 m, 0.175 m, 0.000 m)



Grid: 16 x 16 Points

E_{av} [lx]
153

E_{min} [lx]
141

E_{max} [lx]
169

u_0
0.92

E_{min} / E_{max}
0.83

Calculation Surface 5 / Isolines

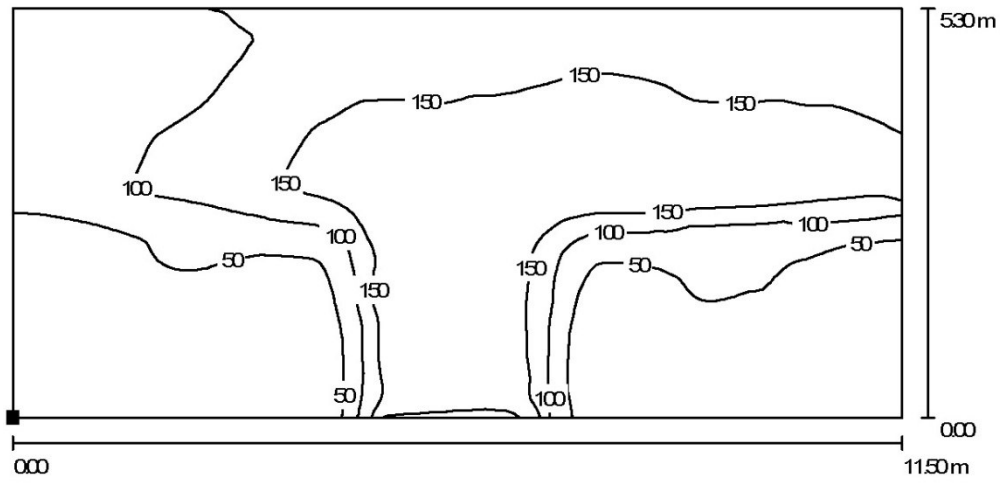

Values in Lux, Scale 1 : 83

Position of surface in room:
Marked point:
(7.001 m, 0.000 m, 0.000 m)



Grid: 128 x 64 Points

E_{av} [lx]	E_{min} [lx]	E_{max} [lx]	$u0$	E_{min} / E_{max}
99	4.29	226	0.04	0.02

Calculation Surface 5 / Greyscale

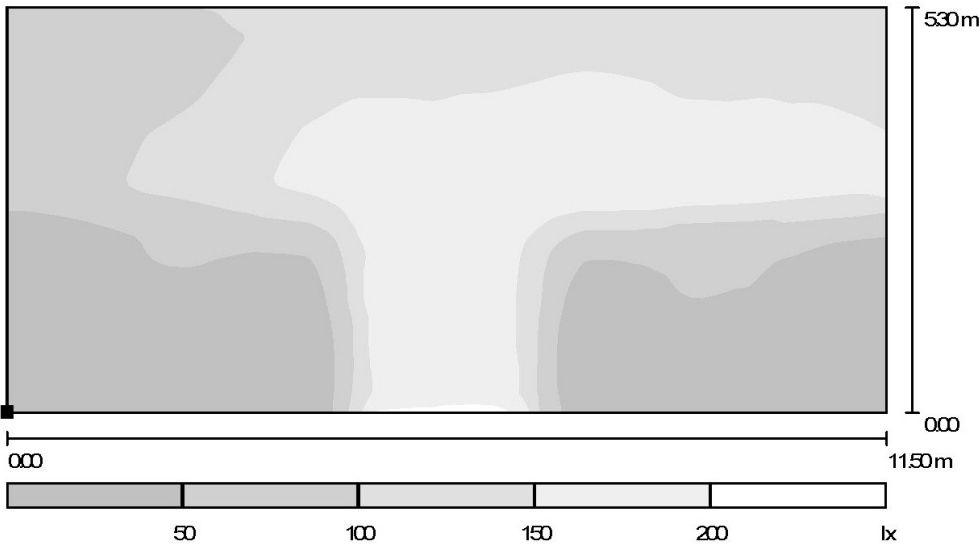

Position of surface in room:
 Marked point:
 (7.001 m, 0.000 m, 0.000 m)



Scale 1 : 83

Grid: 128 x 64 Points

E_{av} [lx]	E_{min} [lx]	E_{max} [lx]	$u0$	E_{min} / E_{max}
99	4.29	226	0.04	0.02

Calculation Surface 5 / Value Chart

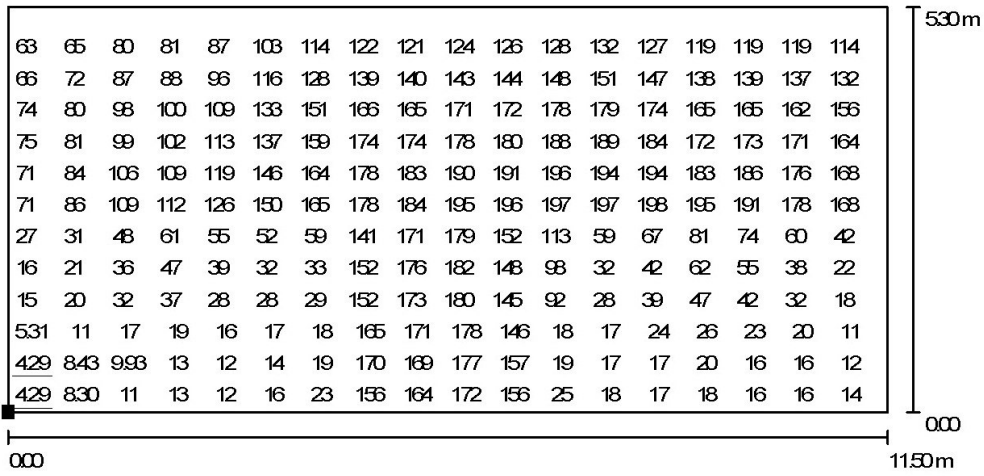

Values in Lux, Scale 1 : 83

Not all calculated values could be displayed.

Position of surface in room:
Marked point:
(7.001 m, 0.000 m, 0.000 m)

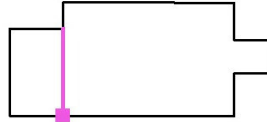

Grid: 128 x 64 Points

E_{av} [lx]
99

E_{min} [lx]
4.29

E_{max} [lx]
226

u_0
0.04

E_{min} / E_{max}
0.02

Calculation Surface 6 / Isolines

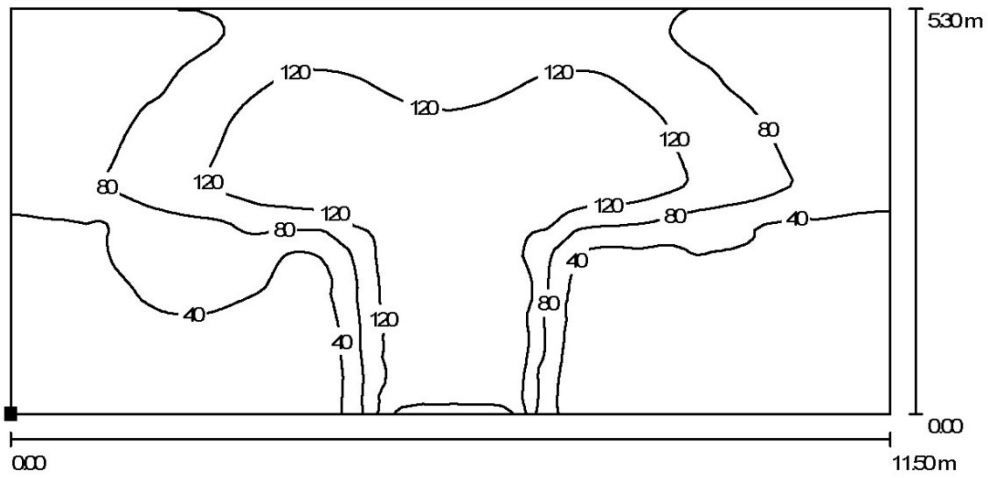

Values in Lux, Scale 1 : 83

Position of surface in room:
 Marked point:
 (6.559 m, 11.500 m, 0.000 m)

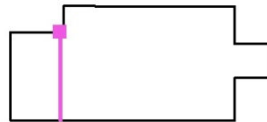

Grid: 128 x 64 Points

E_{av} [lx]	E_{min} [lx]	E_{max} [lx]	$u0$	E_{min} / E_{max}
76	3.20	192	0.04	0.02

Calculation Surface 6 / Greyscale

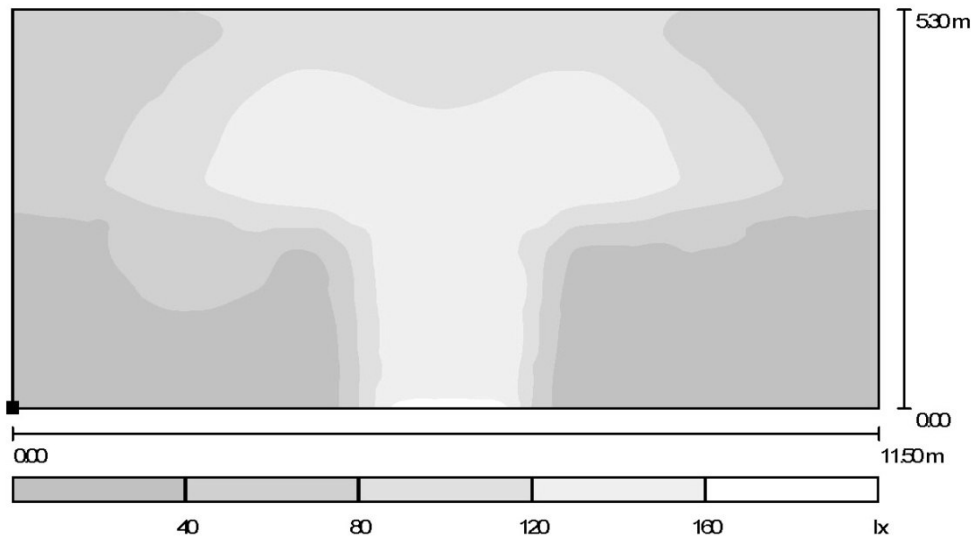

Position of surface in room:
Marked point:
(6.559 m, 11.500 m, 0.000 m)



Scale 1 : 83

Grid: 128 x 64 Points

E_{av} [lx]
76

E_{min} [lx]
3.20

E_{max} [lx]
192

$u0$
0.04

E_{min} / E_{max}
0.02

Calculation Surface 6 / Value Chart

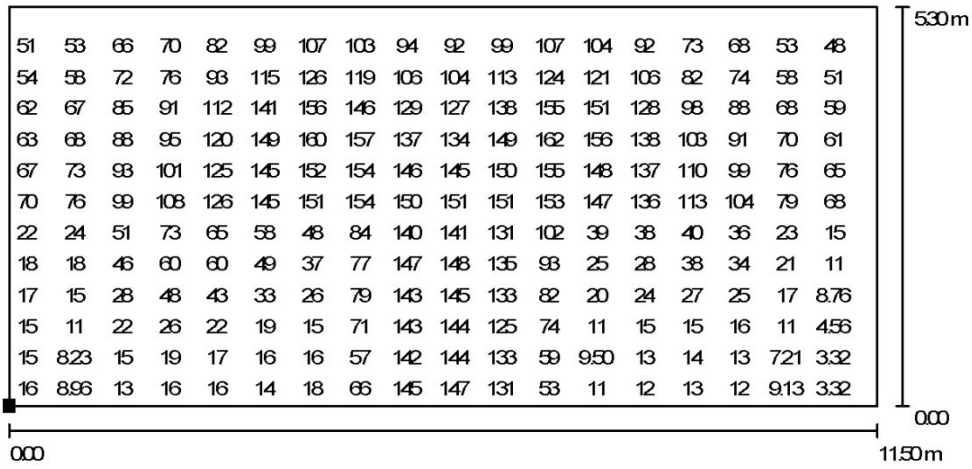

Values in Lux, Scale 1 : 83

Not all calculated values could be displayed.

Position of surface in room:

Marked point:
(6.559 m, 11.500 m, 0.000 m)

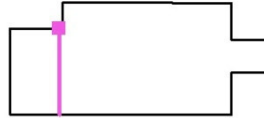

Grid: 128 x 64 Points

E_{av} [lx]
76

E_{min} [lx]
3.20

E_{max} [lx]
192

u_0
0.04

E_{min} / E_{max}
0.02

Floor / Isolines (E)

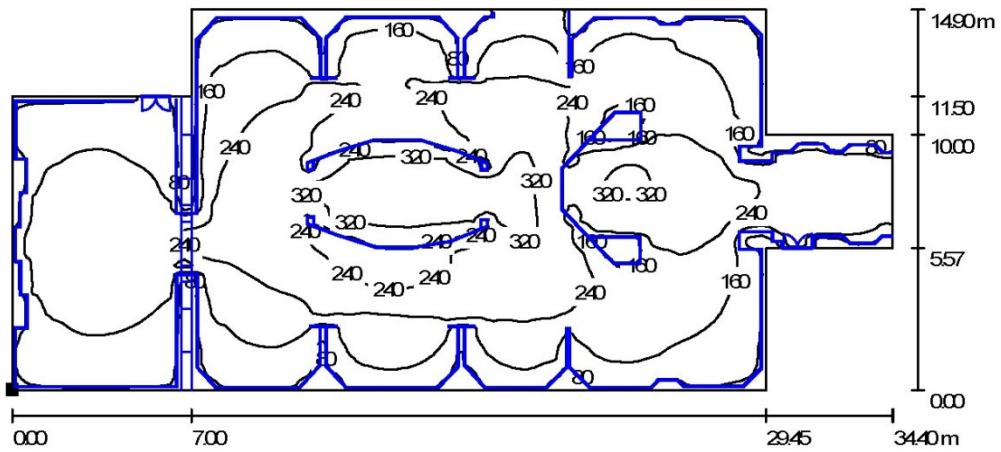

Values in Lux, Scale 1 : 246

Position of surface in room:
Marked point:
(0.000 m, 0.000 m, 0.000 m)



Grid: 128 x 128 Points

E_{av} [lx]	E_{min} [lx]	E_{max} [lx]	$u0$	E_{min} / E_{max}
195	6.10	398	0.03	0.02

Floor / Greyscale (E)

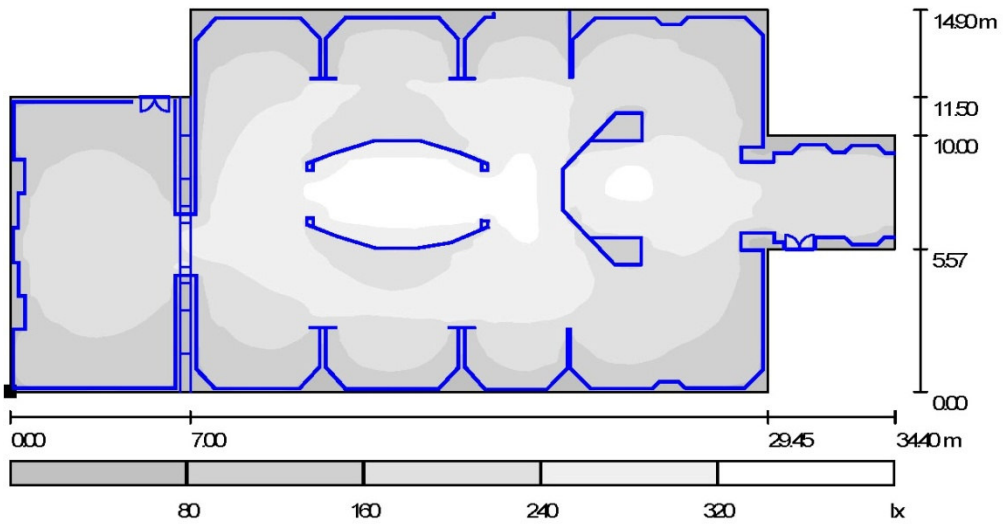

Scale 1 : 246

Position of surface in room:
Marked point:
(0.000 m, 0.000 m, 0.000 m)



Grid: 128 x 128 Points

E_{av} [lx]	E_{min} [lx]	E_{max} [lx]	u_0	E_{min} / E_{max}
195	6.10	398	0.03	0.02

Floor / Value Chart (E)

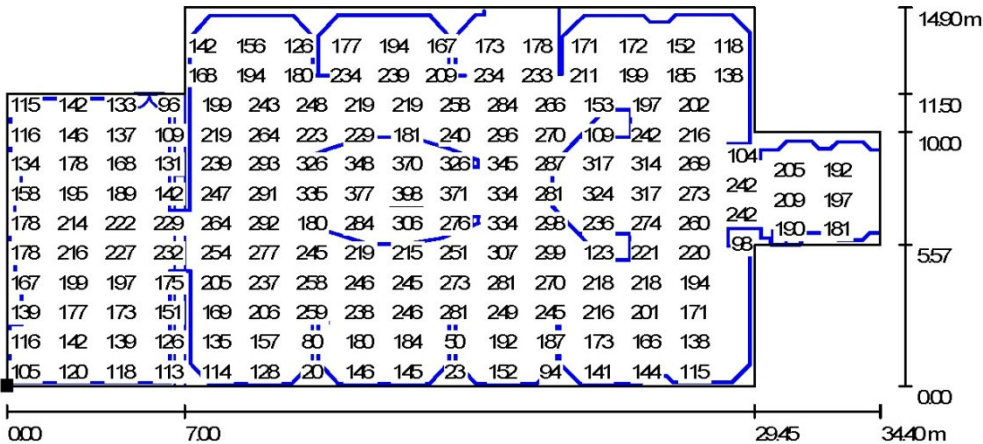

Values in Lux, Scale 1 : 246

Not all calculated values could be displayed.

Position of surface in room:
Marked point:
(0.000 m, 0.000 m, 0.000 m)



Grid: 128 x 128 Points

E_{av} [lx]	E_{min} [lx]	E_{max} [lx]	u_0	E_{min} / E_{max}
195	6.10	398	0.03	0.02

Ceiling / Greyscale (E)

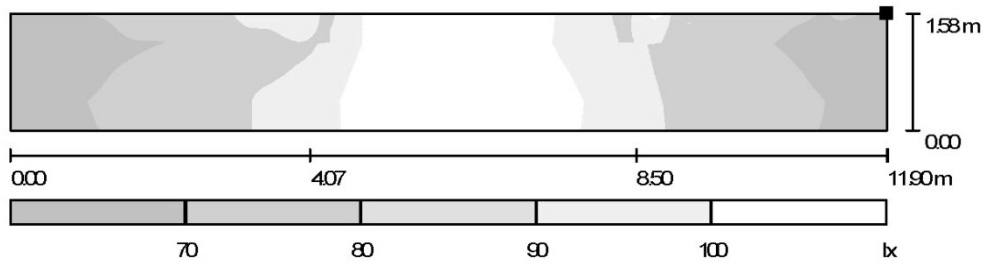

Position of surface in room:
Marked point:
(29.450 m, 13.400 m, 5.800 m)

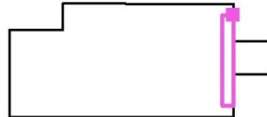

Scale 1 : 86

Grid: 128 x 128 Points

E_{av} [lx]
85

E_{min} [lx]
61

E_{max} [lx]
109

$u0$
0.71

E_{min} / E_{max}
0.56

Ceiling / Value Chart (E)

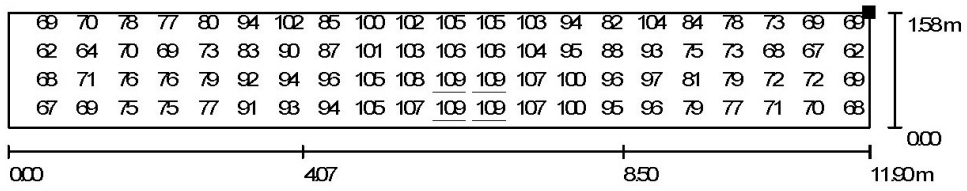

Values in Lux, Scale 1 : 86

Not all calculated values could be displayed.

Position of surface in room:

Marked point:
(29.450 m, 13.400 m, 5.800 m)



Grid: 128 x 128 Points

E_{av} [lx]	E_{min} [lx]	E_{max} [lx]	u_0	E_{min} / E_{max}
85	61	109	0.71	0.56

Ceiling / Greyscale (E)

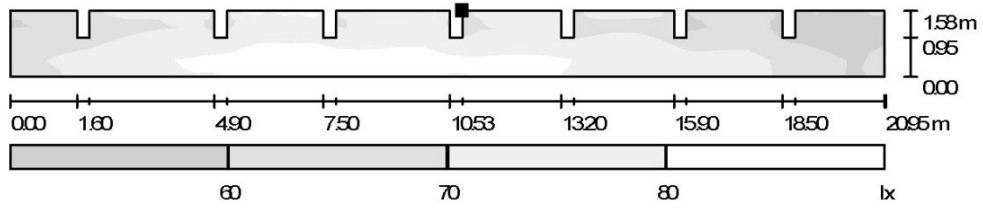

Position of surface in room:
Marked point:
(17.120 m, 14.900 m, 5.800 m)



Grid: 128 x 128 Points

E_{av} [lx]
72

E_{min} [lx]
49

E_{max} [lx]
87

$u0$
0.68

E_{min} / E_{max}
0.56

Ceiling / Value Chart (E)

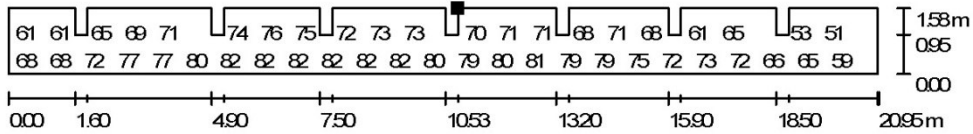

Values in Lux, Scale 1 : 150

Not all calculated values could be displayed.

Position of surface in room:
Marked point:
(17.120 m, 14.900 m, 5.800 m)



Grid: 128 x 128 Points

E_{av} [lx]	E_{min} [lx]	E_{max} [lx]	u_0	E_{min} / E_{max}
72	49	87	0.68	0.56

Ceiling / Greyscale (E)

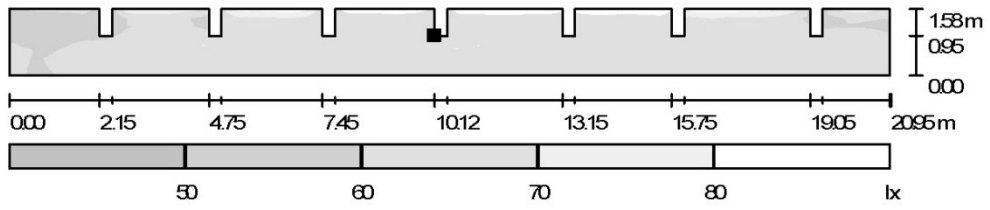

Position of surface in room:
Marked point:
(17.120 m, 0.600 m, 5.600 m)

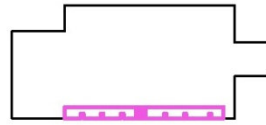

Scale 1 : 150

Grid: 128 x 128 Points

E_{av} [lx]
73

E_{min} [lx]
45

E_{max} [lx]
90

$u0$
0.61

E_{min} / E_{max}
0.50

Ceiling / Value Chart (E)

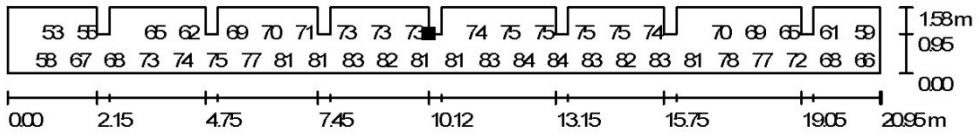

Values in Lux, Scale 1 : 150

Not all calculated values could be displayed.

Position of surface in room:
Marked point:
(17.120 m, 0.600 m, 5.600 m)



Grid: 128 x 128 Points

E_{av} [lx]	E_{min} [lx]	E_{max} [lx]	u0	E_{min} / E_{max}
73	45	90	0.61	0.50

Ceiling / Isolines (E)

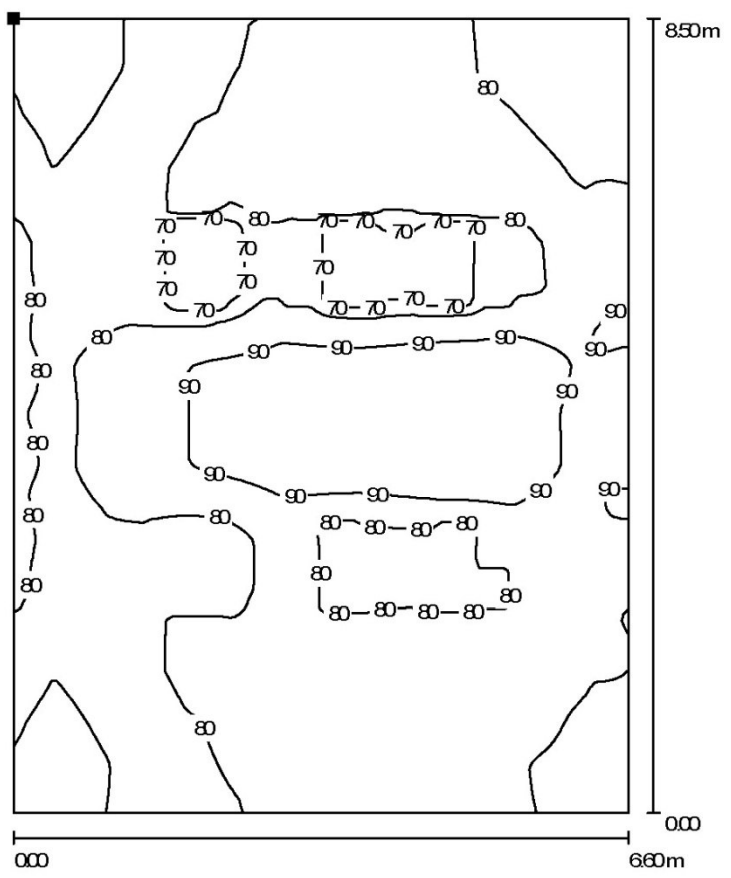

Position of surface in room:
 Marked point:
 (0.000 m, 1.500 m, 5.300 m)



Values in Lux, Scale 1 : 67

Grid: 128 x 128 Points

E_{av} [lx]	E_{min} [lx]	E_{max} [lx]	u_0	E_{min} / E_{max}
81	61	98	0.75	0.63

Ceiling / Greyscale (E)

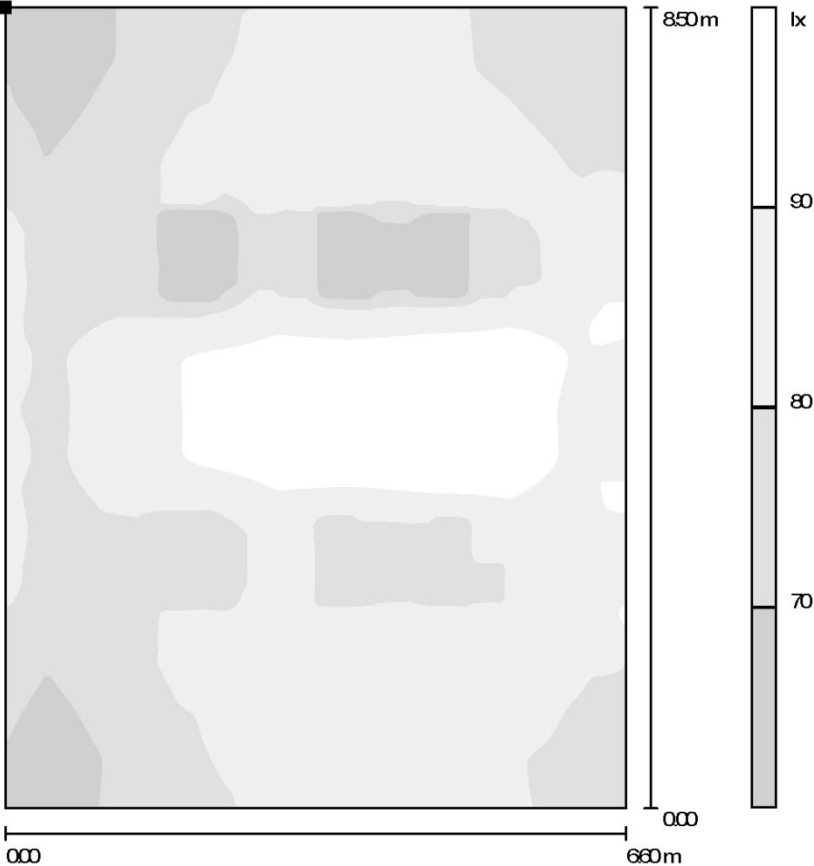

Position of surface in room:
 Marked point:
 (0.000 m, 1.500 m, 5.300 m)

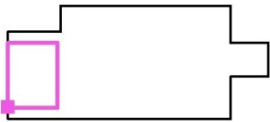

Scale 1 : 67

Grid: 128 x 128 Points

E_{av} [lx]	E_{min} [lx]	E_{max} [lx]	u_0	E_{min} / E_{max}
81	61	98	0.75	0.63

Ceiling / Value Chart (E)

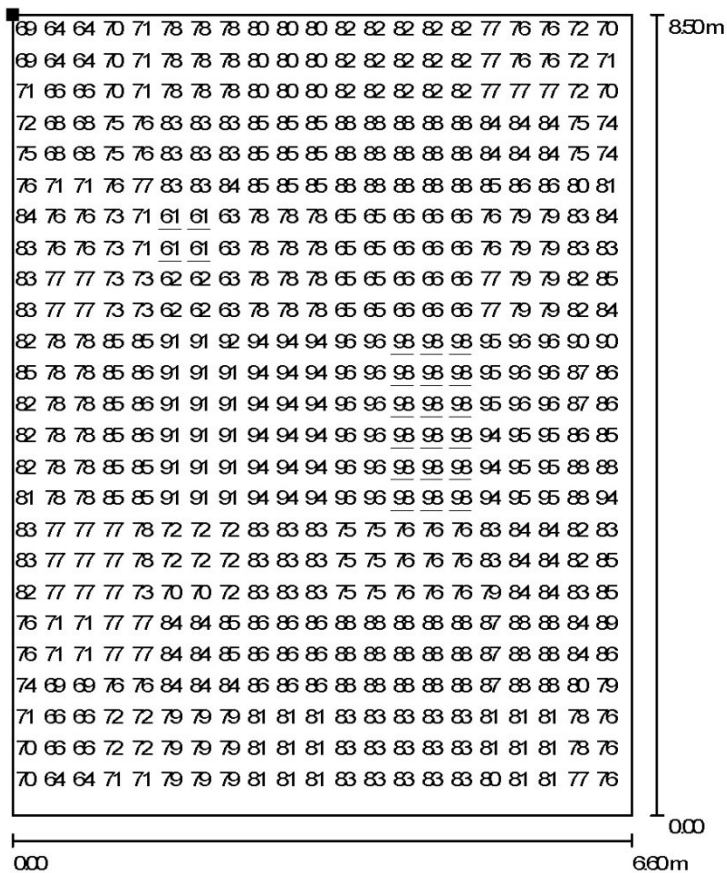

Values in Lux, Scale 1 : 67

Not all calculated values could be displayed.

Position of surface in room:
Marked point:
(0.000 m, 1.500 m, 5.300 m)



Grid: 128 x 128 Points

E_{av} [lx]	E_{min} [lx]	E_{max} [lx]	u_0	E_{min} / E_{max}
81	61	98	0.75	0.63

Ceiling / Greyscale (E)

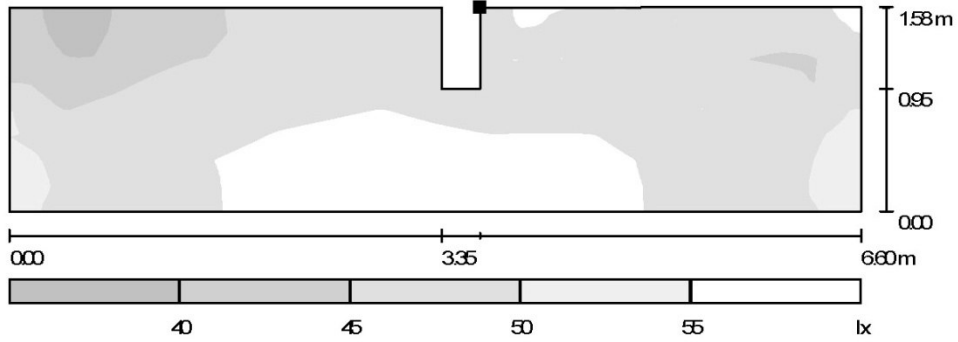

Scale 1 : 48

Position of surface in room:
Marked point:
(2.950 m, 11.500 m, 5.800 m)



Grid: 128 x 128 Points

E_{av} [lx]	E_{min} [lx]	E_{max} [lx]	u_0	E_{min} / E_{max}
51	39	59	0.76	0.65

Ceiling / Value Chart (E)

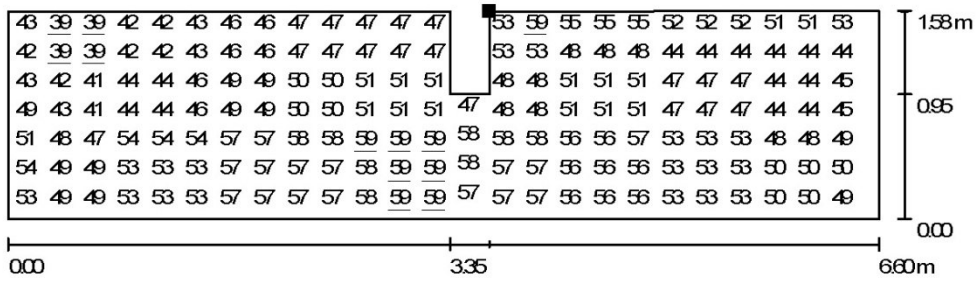

Values in Lux, Scale 1 : 48

Not all calculated values could be displayed.

Position of surface in room:

Marked point:
(2.950 m, 11.500 m, 5.800 m)



Grid: 128 x 128 Points

E_{av} [lx]
51

E_{min} [lx]
39

E_{max} [lx]
59

u_0
0.76

E_{min} / E_{max}
0.65

Ceiling / Greyscale (E)

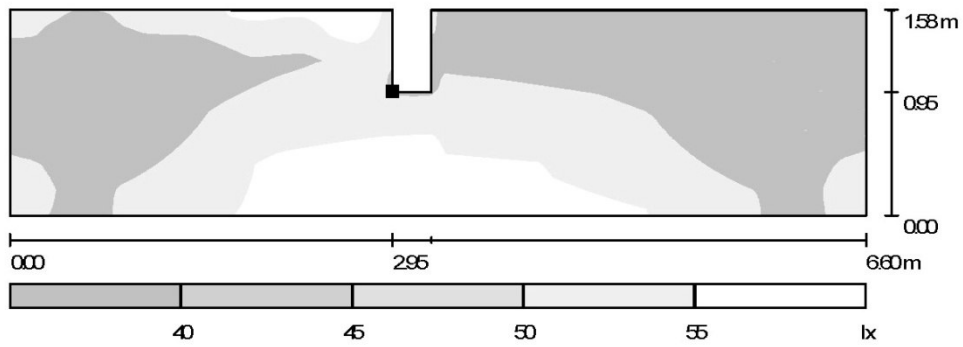

Position of surface in room:
 Marked point:
 (2.950 m, 0.600 m, 5.600 m)



Scale 1 : 48

Grid: 128 x 128 Points

E_{av} [lx]	E_{min} [lx]	E_{max} [lx]	$u0$	E_{min} / E_{max}
50	38	61	0.75	0.62

Ceiling / Value Chart (E)

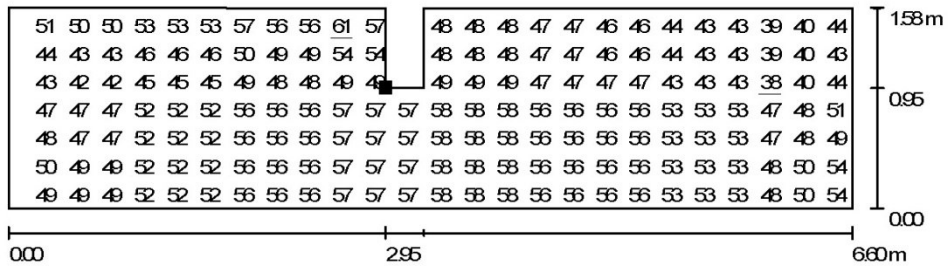

Values in Lux, Scale 1 : 48

Not all calculated values could be displayed.

Position of surface in room:

Marked point:
(2.950 m, 0.600 m, 5.600 m)



Grid: 128 x 128 Points

E_{av} [lx]
50

E_{min} [lx]
38

E_{max} [lx]
61

u0
0.75

E_{min} / E_{max}
0.62

Ceiling / Isolines (E)

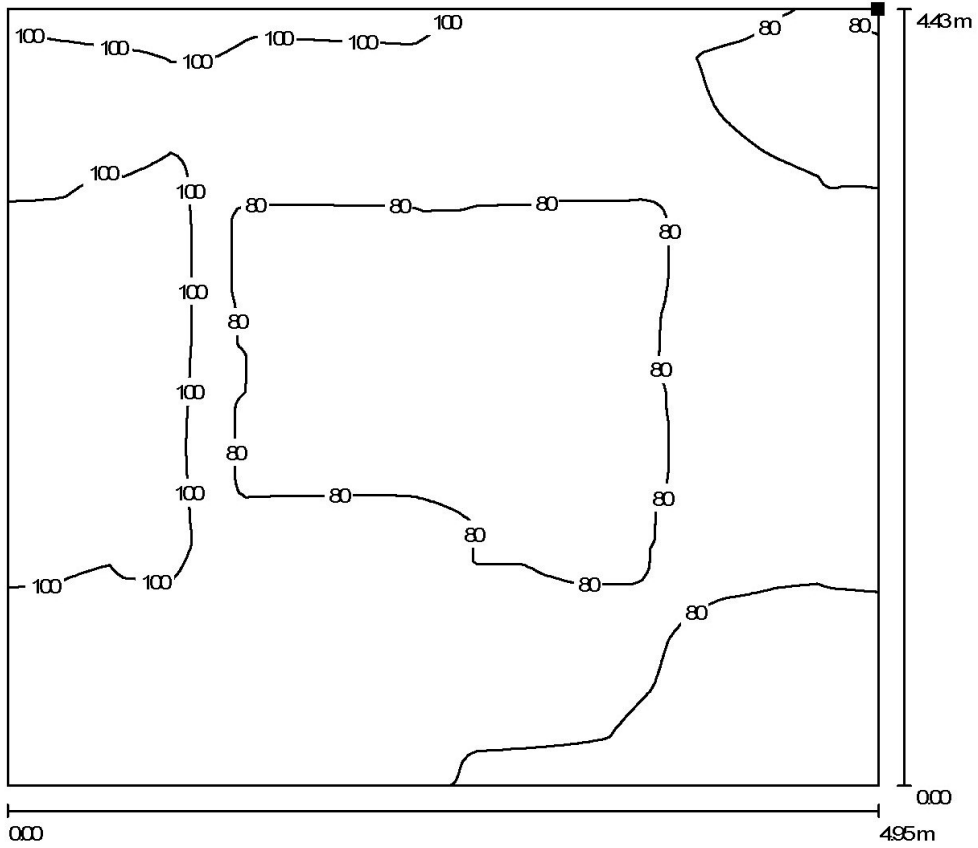

Values in Lux, Scale 1 : 36

Position of surface in room:
Marked point:
(34.400 m, 5.570 m, 5.800 m)



Grid: 128 x 128 Points

E_{av} [lx]	E_{min} [lx]	E_{max} [lx]	$u0$	E_{min} / E_{max}
87	62	112	0.71	0.55

Ceiling / Greyscale (E)

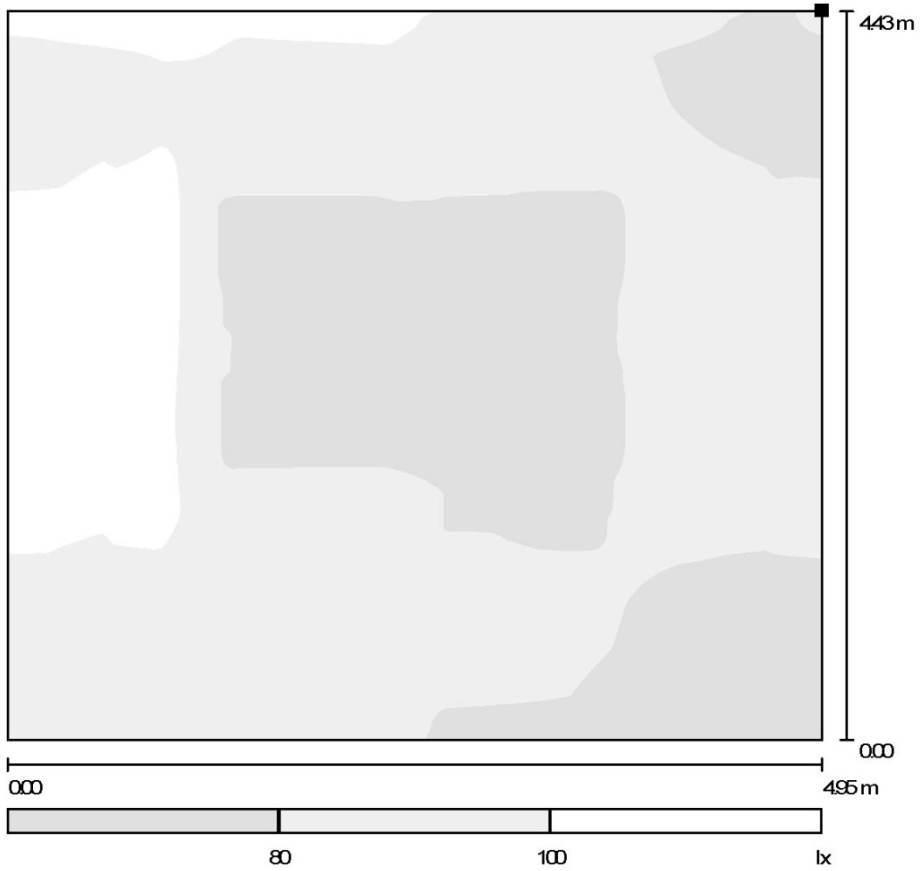

Scale 1 : 38

Position of surface in room:
Marked point:
(34.400 m, 5.570 m, 5.800 m)



Grid: 128 x 128 Points

E_{av} [lx]	E_{min} [lx]	E_{max} [lx]	u_0	E_{min} / E_{max}
87	62	112	0.71	0.55

Ceiling / Value Chart (E)

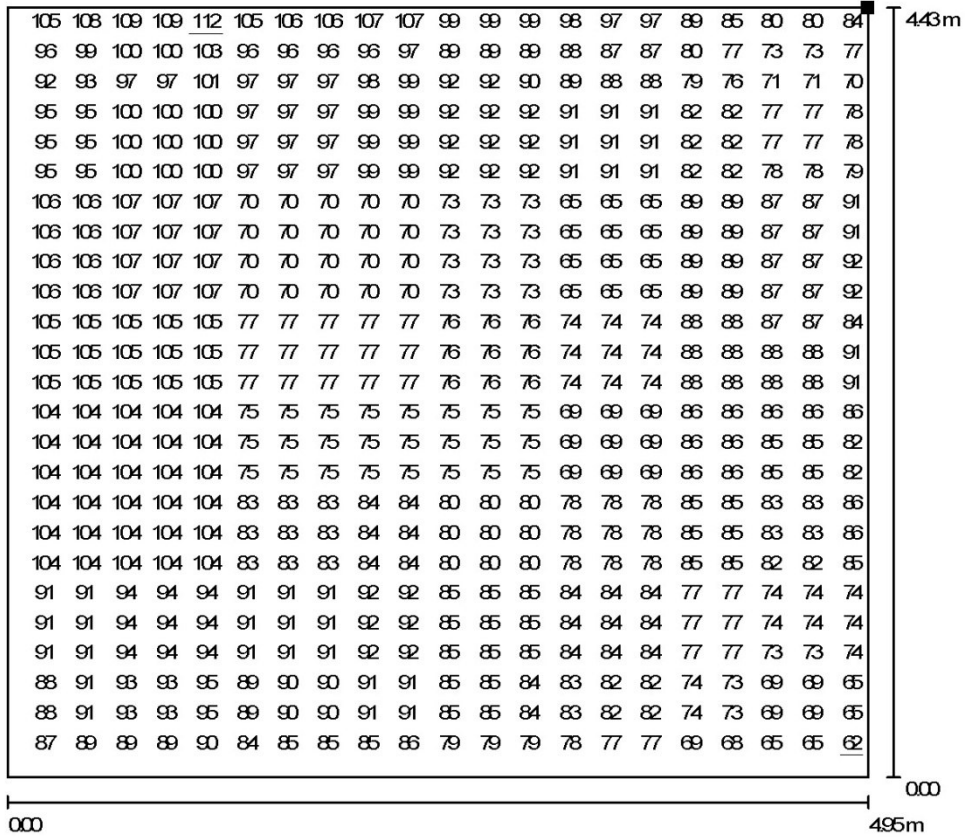

Values in Lux, Scale 1 : 36

Not all calculated values could be displayed.

Position of surface in room:
Marked point:
(34.400 m, 5.570 m, 5.800 m)



Grid: 128 x 128 Points

E_{av} [lx]
87

E_{min} [lx]
62

E_{max} [lx]
112

u_0
0.71

E_{min} / E_{max}
0.55

Ceiling / Isolines (E)

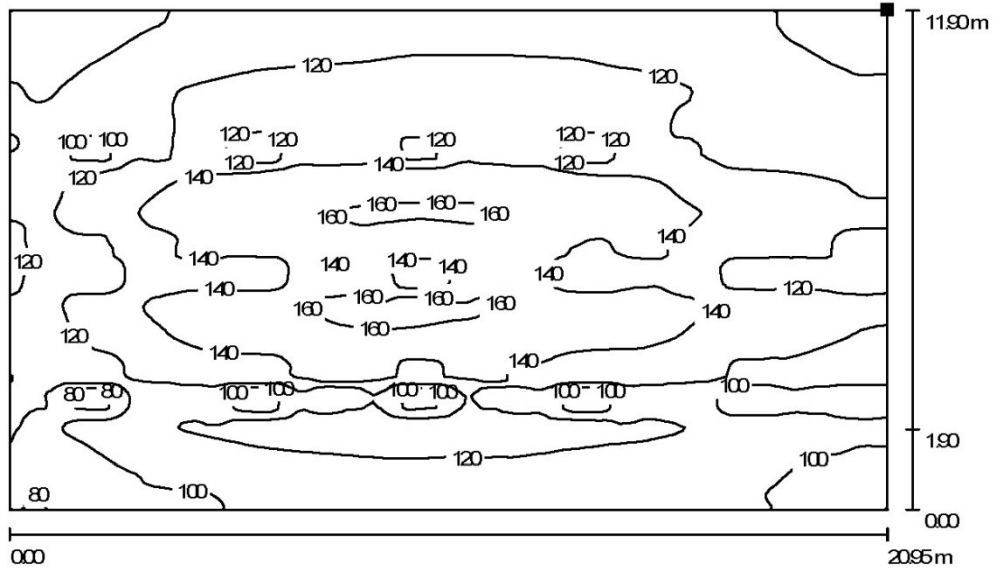

Values in Lux, Scale 1 : 150

Position of surface in room:
 Marked point:
 (27.950 m, 1.500 m, 5.300 m)

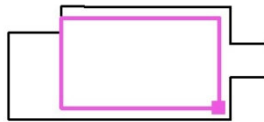

Grid: 128 x 128 Points

E_{av} [lx]	E_{min} [lx]	E_{max} [lx]	u_0	E_{min} / E_{max}
123	77	165	0.62	0.47

Ceiling / Greyscale (E)

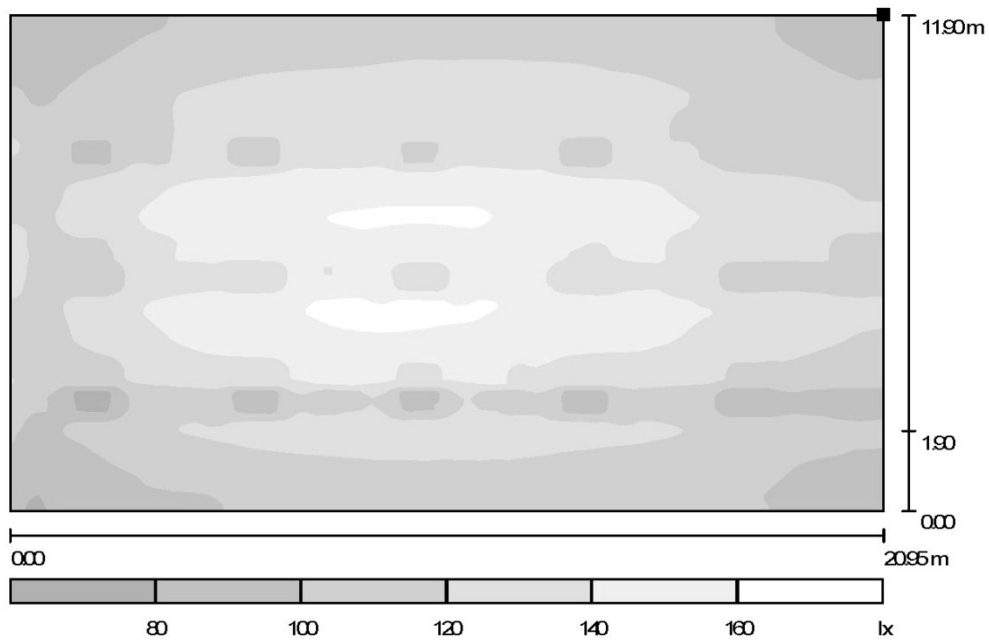

Scale 1 : 150

Position of surface in room:
Marked point:
(27.950 m, 1.500 m, 5.300 m)

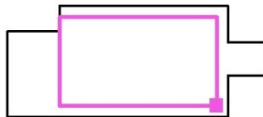

Grid: 128 x 128 Points

E_{av} [lx]
123

E_{min} [lx]
77

E_{max} [lx]
165

u_0
0.62

E_{min} / E_{max}
0.47

Ceiling / Value Chart (E)

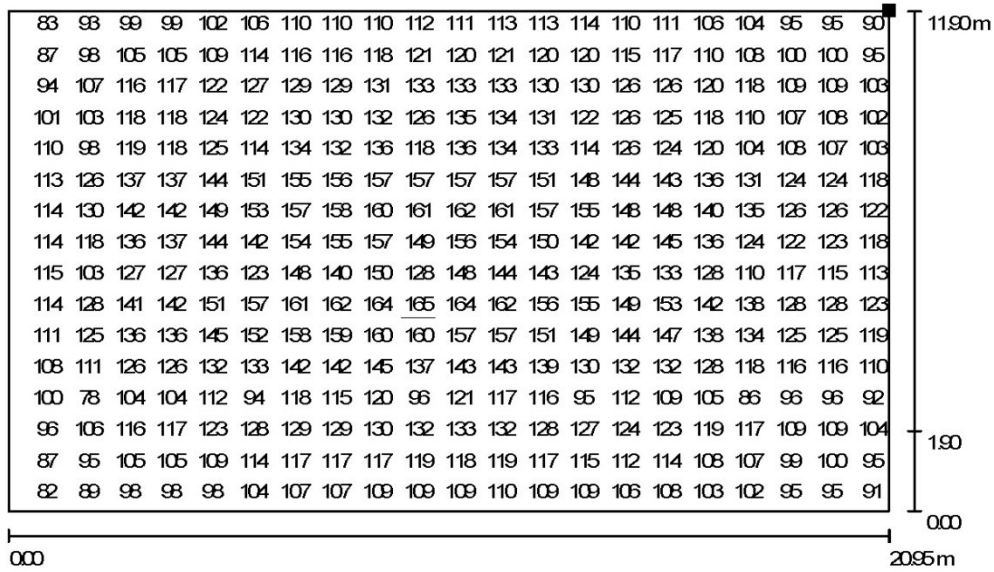

Values in Lux, Scale 1 : 150

Not all calculated values could be displayed.

Position of surface in room:
Marked point:
(27.950 m, 1.500 m, 5.300 m)



Grid: 128 x 128 Points

E_{av} [lx]	E_{min} [lx]	E_{max} [lx]	u_0	E_{min} / E_{max}
123	77	165	0.62	0.47

Wall / Greyscale (E)

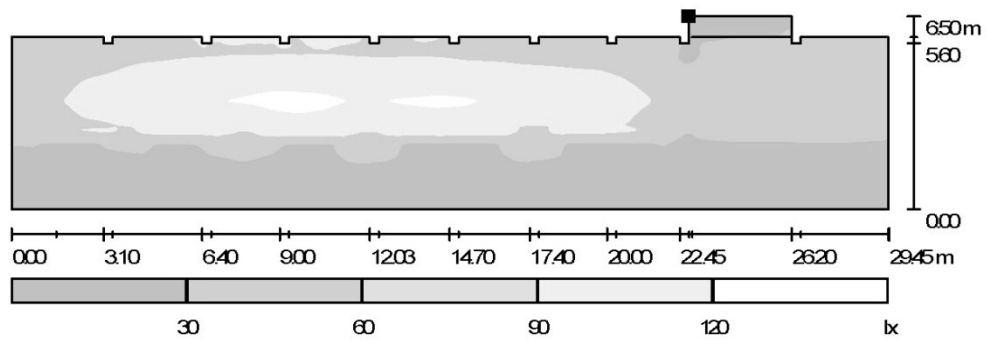

Scale 1 : 211

Position of surface in room:
Marked point:
(6.700 m, 0.000 m, 6.500 m)

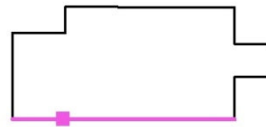

Grid: 128 x 128 Points

E_{av} [lx]
56

E_{min} [lx]
1.44

E_{max} [lx]
128

$u0$
0.03

E_{min} / E_{max}
0.01

Wall / Value Chart (E)

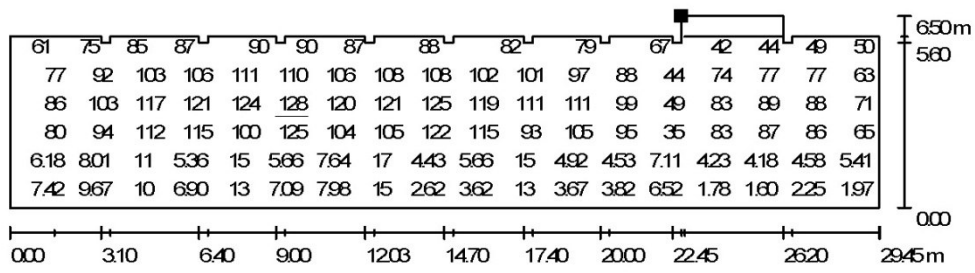

Values in Lux, Scale 1 : 211

Not all calculated values could be displayed.

Position of surface in room:

Marked point:

(6.700 m, 0.000 m, 6.500 m)

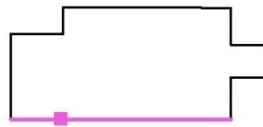

Grid: 128 x 128 Points

E_{av} [lx]
56

E_{min} [lx]
1.44

E_{max} [lx]
128

u_0
0.03

E_{min} / E_{max}
0.01

Wall / Greyscale (E)

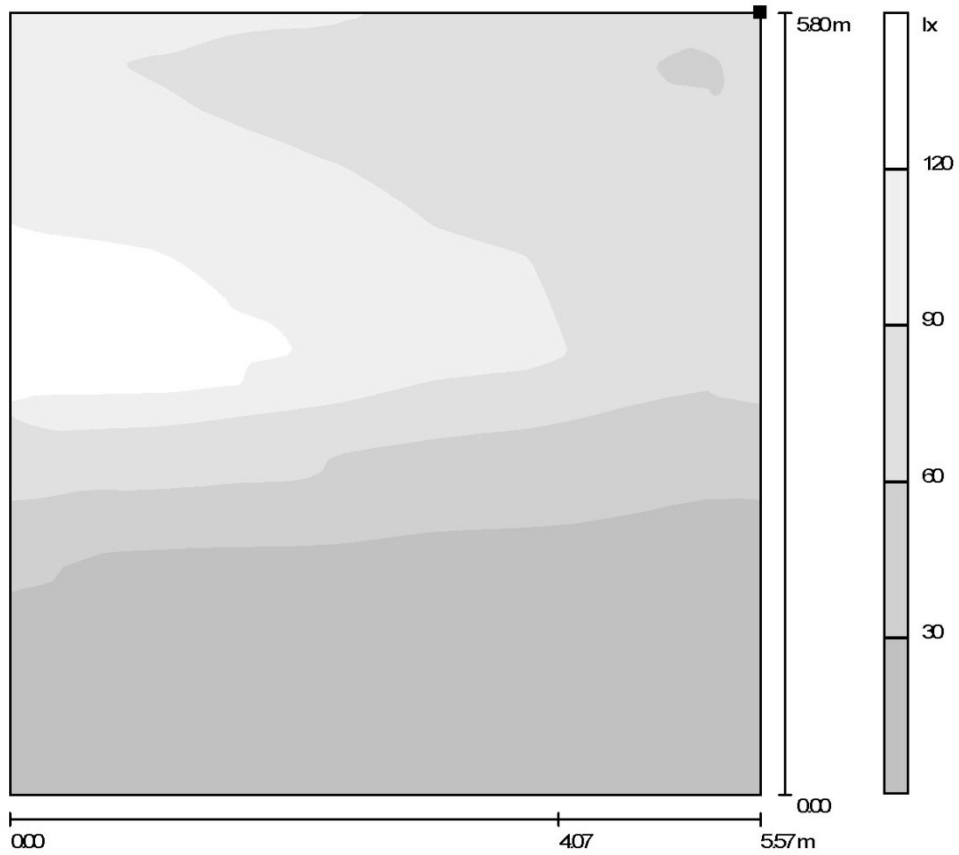

Scale 1 : 46

Position of surface in room:
Marked point:
(29.450 m, 0.000 m, 5.800 m)



Grid: 128 x 128 Points

E_{av} [lx]
59

E_{min} [lx]
5.97

E_{max} [lx]
138

u_0
0.10

E_{min} / E_{max}
0.04

Wall / Value Chart (E)

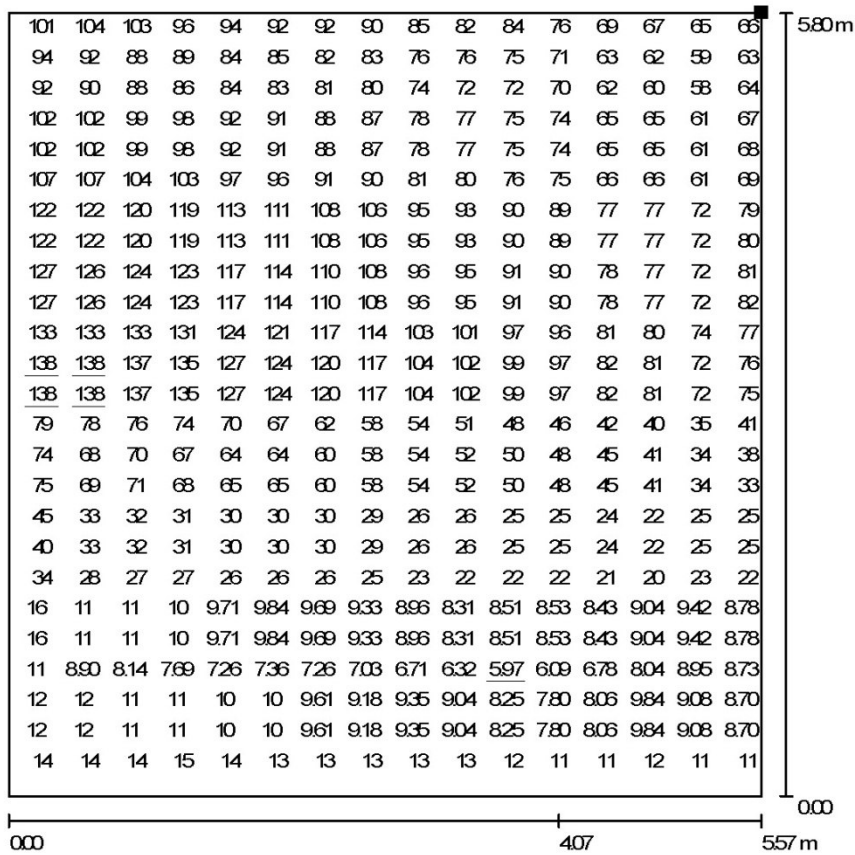

Values in Lux, Scale 1 : 46

Not all calculated values could be displayed.

Position of surface in room:
Marked point:
(29.450 m, 0.000 m, 5.800 m)



Grid: 128 x 128 Points

E_{av} [lx]
59

E_{min} [lx]
5.97

E_{max} [lx]
138

u_0
0.10

E_{min} / E_{max}
0.04

Wall / Greyscale (E)

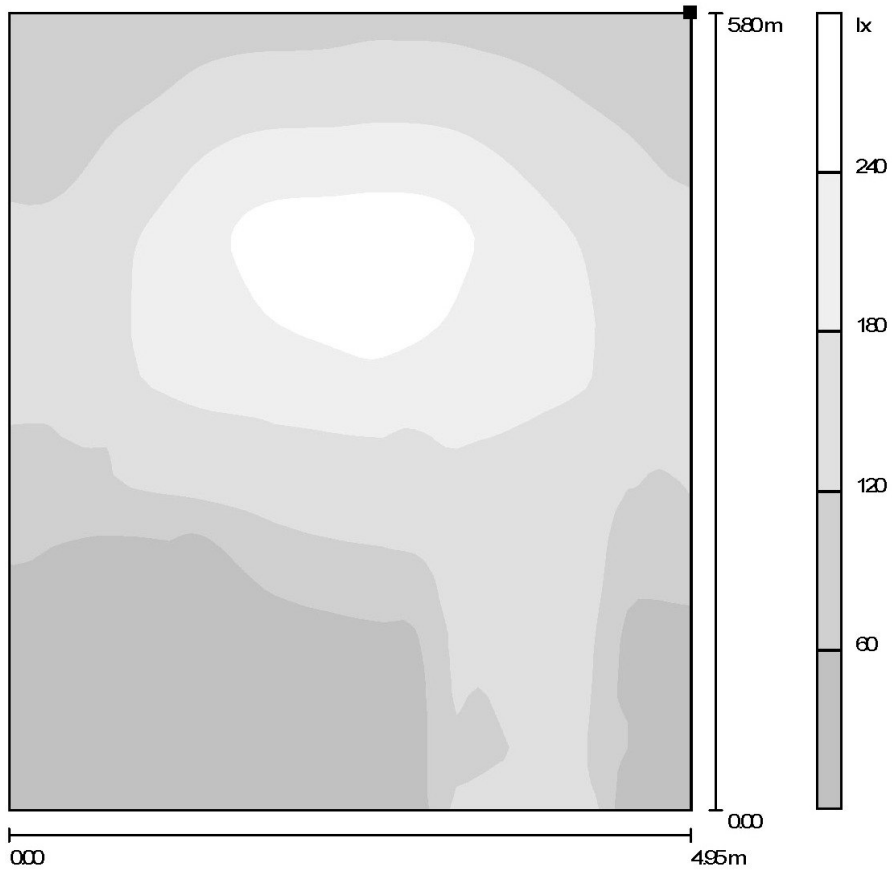

Position of surface in room:
 Marked point:
 (29.450 m, 5.570 m, 5.800 m)

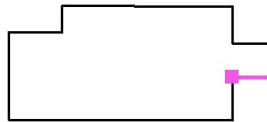

Scale 1 : 46

Grid: 64 x 64 Points

E_{av} [lx]	E_{min} [lx]	E_{max} [lx]	$u0$	E_{min} / E_{max}
128	12	275	0.09	0.04

Wall / Value Chart (E)

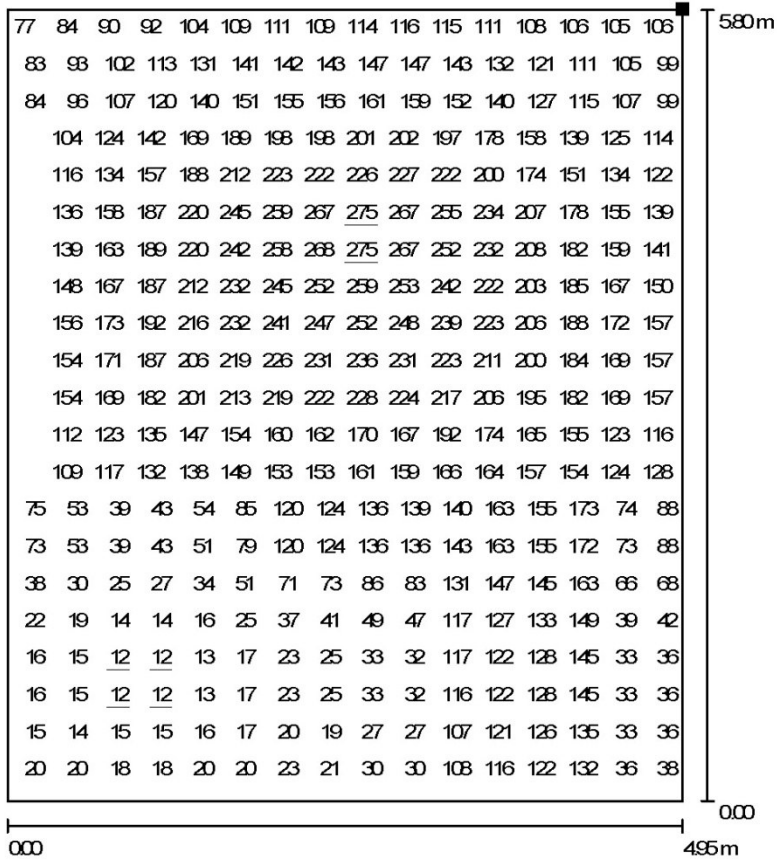

Values in Lux, Scale 1 : 46

Not all calculated values could be displayed.

Position of surface in room:
Marked point:
(29.450 m, 5.570 m, 5.800 m)

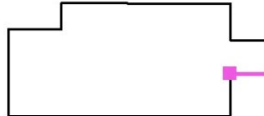

Grid: 64 x 64 Points

E_{av} [lx]
128

E_{min} [lx]
12

E_{max} [lx]
275

u_0
0.09

E_{min} / E_{max}
0.04

Wall / Greyscale (E)

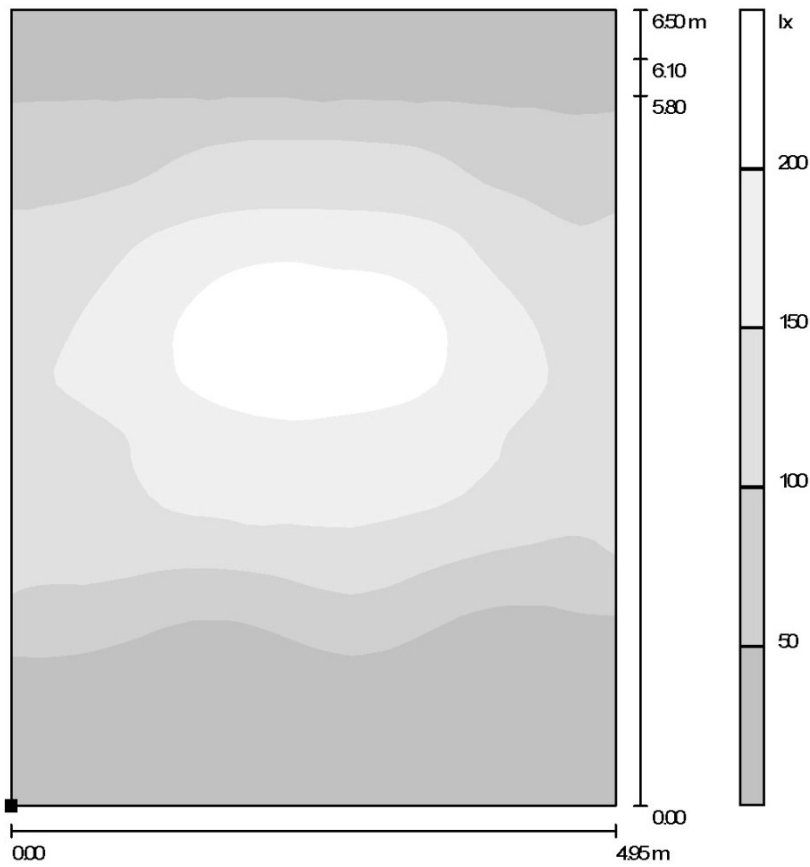

Position of surface in room:
 Marked point:
 (29.450 m, 10.000 m, 0.000 m)

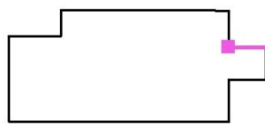

Scale 1 : 51

Grid: 64 x 64 Points

E_{av} [lx]
100

E_{min} [lx]
15

E_{max} [lx]
240

$u0$
0.15

E_{min} / E_{max}
0.06

Wall / Value Chart (E)

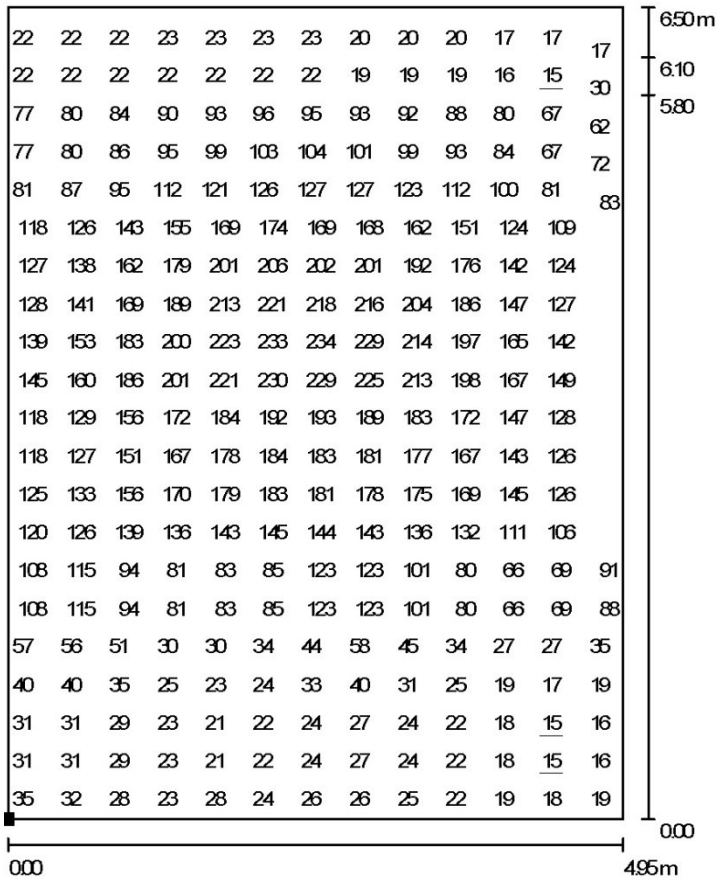

Values in Lux, Scale 1 : 51

Not all calculated values could be displayed.

Position of surface in room:
Marked point:
(29.450 m, 10.000 m, 0.000 m)



Grid: 64 x 64 Points

E_{av} [lx]
100

E_{min} [lx]
15

E_{max} [lx]
240

u_0
0.15

E_{min} / E_{max}
0.06

Wall / Greyscale (E)

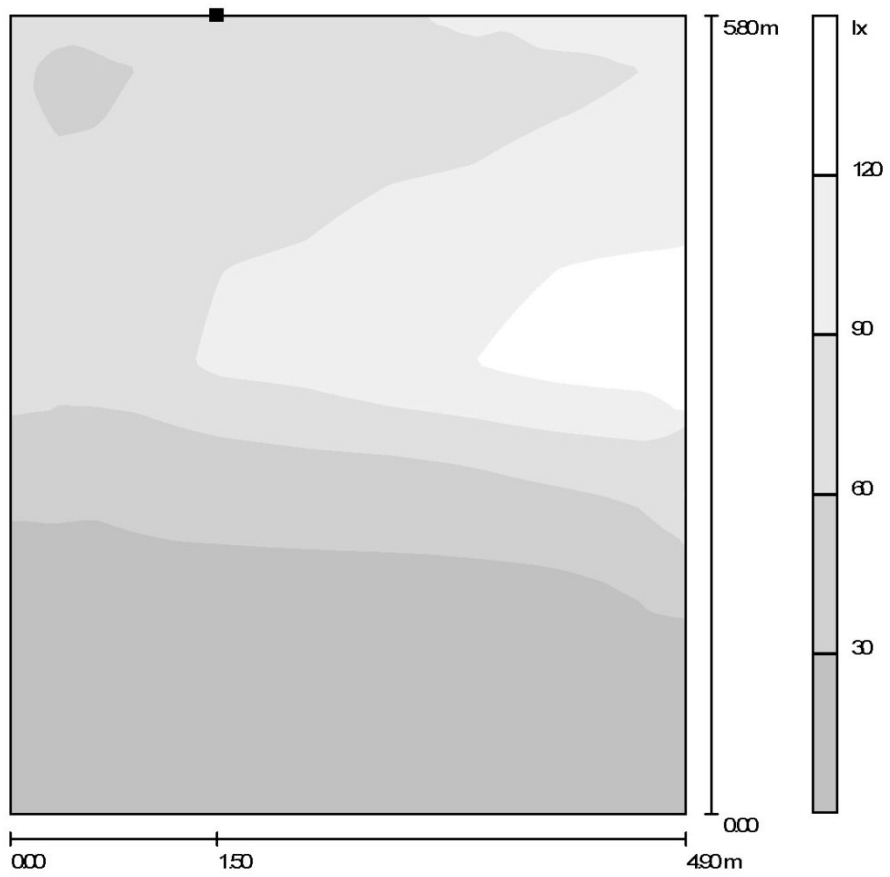

Position of surface in room:
 Marked point:
 (29.450 m, 13.400 m, 5.800 m)



Scale 1 : 46

Grid: 128 x 128 Points

E_{av} [lx]	E_{min} [lx]	E_{max} [lx]	u_0	E_{min} / E_{max}
59	6.22	137	0.11	0.05

Wall / Value Chart (E)

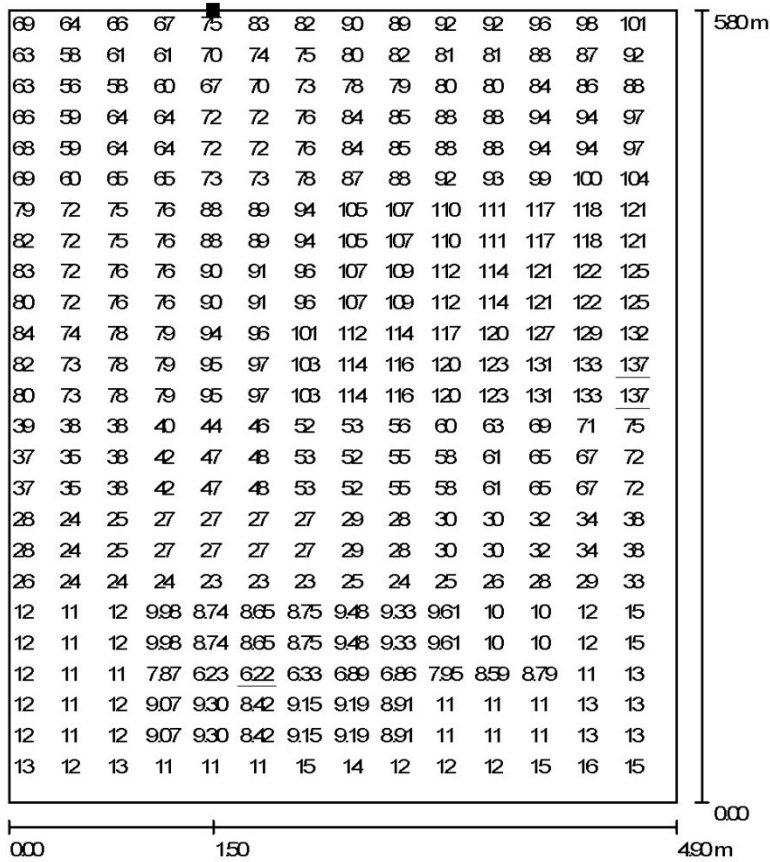

Values in Lux, Scale 1 : 46

Not all calculated values could be displayed.

Position of surface in room:
Marked point:
(29.450 m, 13.400 m, 5.800 m)



Grid: 128 x 128 Points

E_{av} [lx]
59

E_{min} [lx]
6.22

E_{max} [lx]
137

u_0
0.11

E_{min} / E_{max}
0.05

Wall / Greyscale (E)

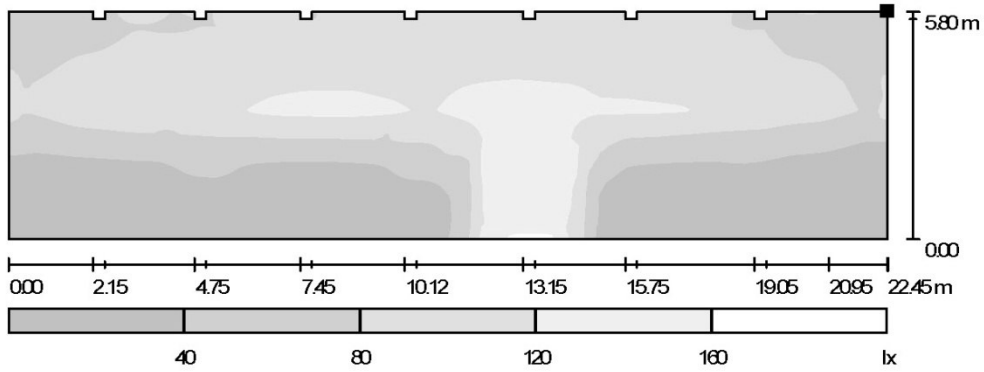

Position of surface in room:
 Marked point:
 (29.450 m, 14.900 m, 5.800 m)



Scale 1 : 161

Grid: 128 x 128 Points

E_{av} [lx]	E_{min} [lx]	E_{max} [lx]	u_0	E_{min} / E_{max}
73	7.14	174	0.10	0.04

Wall / Value Chart (E)

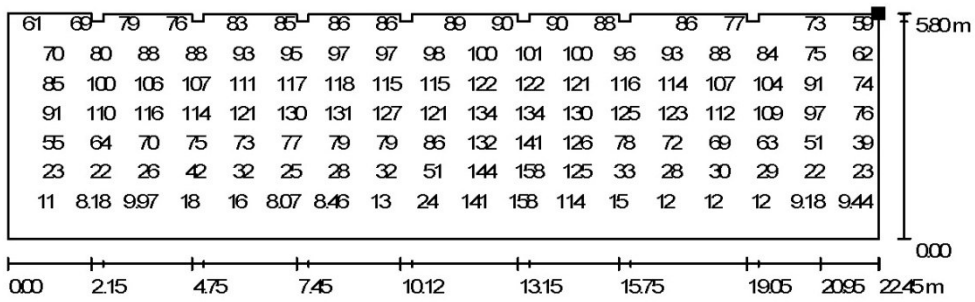

Values in Lux, Scale 1 : 161

Not all calculated values could be displayed.

Position of surface in room:
Marked point:
(29.450 m, 14.900 m, 5.800 m)



Grid: 128 x 128 Points

E_{av} [lx]
73

E_{min} [lx]
7.14

E_{max} [lx]
174

u_0
0.10

E_{min} / E_{max}
0.04

Wall / Greyscale (E)

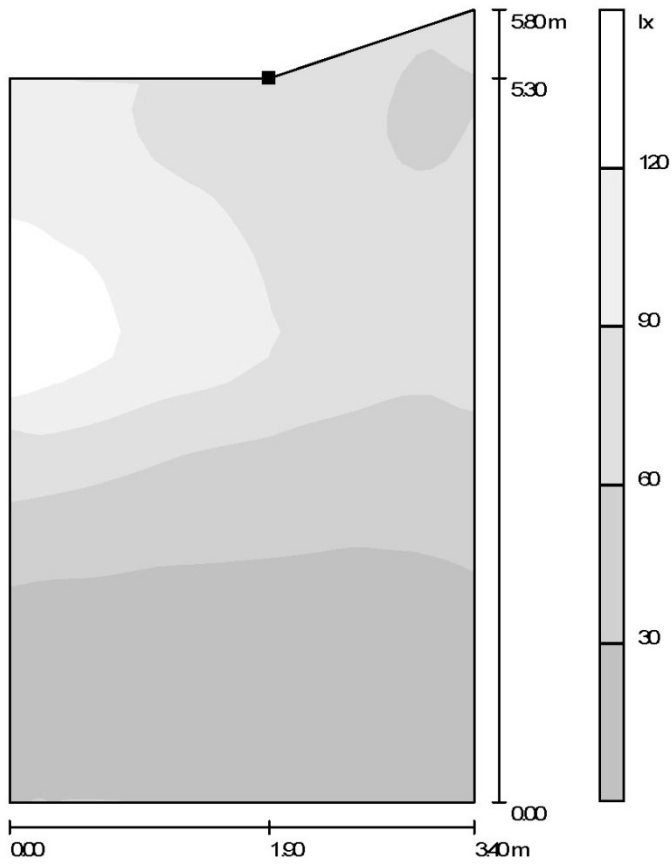

Position of surface in room:
 Marked point:
 (7.000 m, 13.400 m, 5.300 m)



Scale 1 : 46

Grid: 32 x 32 Points

E_{av} [lx]
57

E_{min} [lx]
12

E_{max} [lx]
143

$u0$
0.21

E_{min} / E_{max}
0.08

Wall / Value Chart (E)

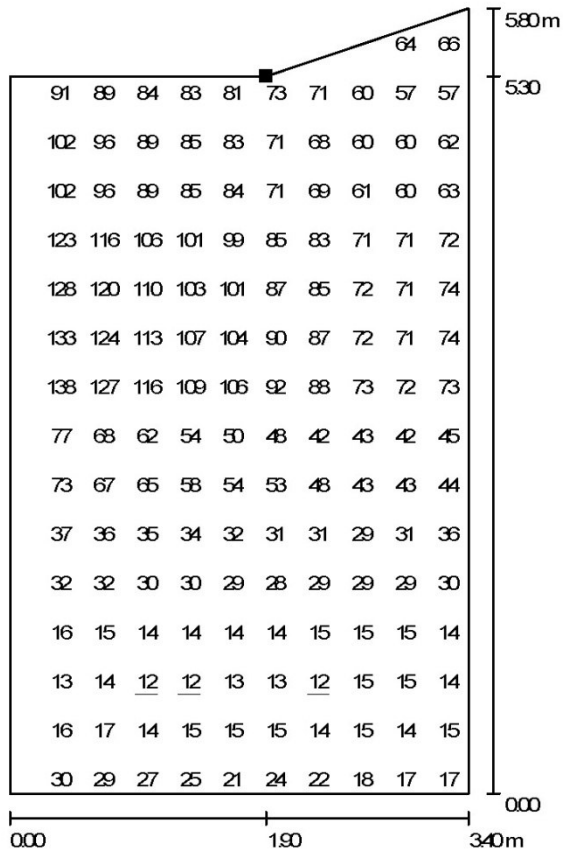

Values in Lux, Scale 1 : 46

Not all calculated values could be displayed.

Position of surface in room:
Marked point:
(7.000 m, 13.400 m, 5.300 m)



Grid: 32 x 32 Points

E_{av} [lx]
57

E_{min} [lx]
12

E_{max} [lx]
143

u_0
0.21

E_{min} / E_{max}
0.08

Wall / Greyscale (E)

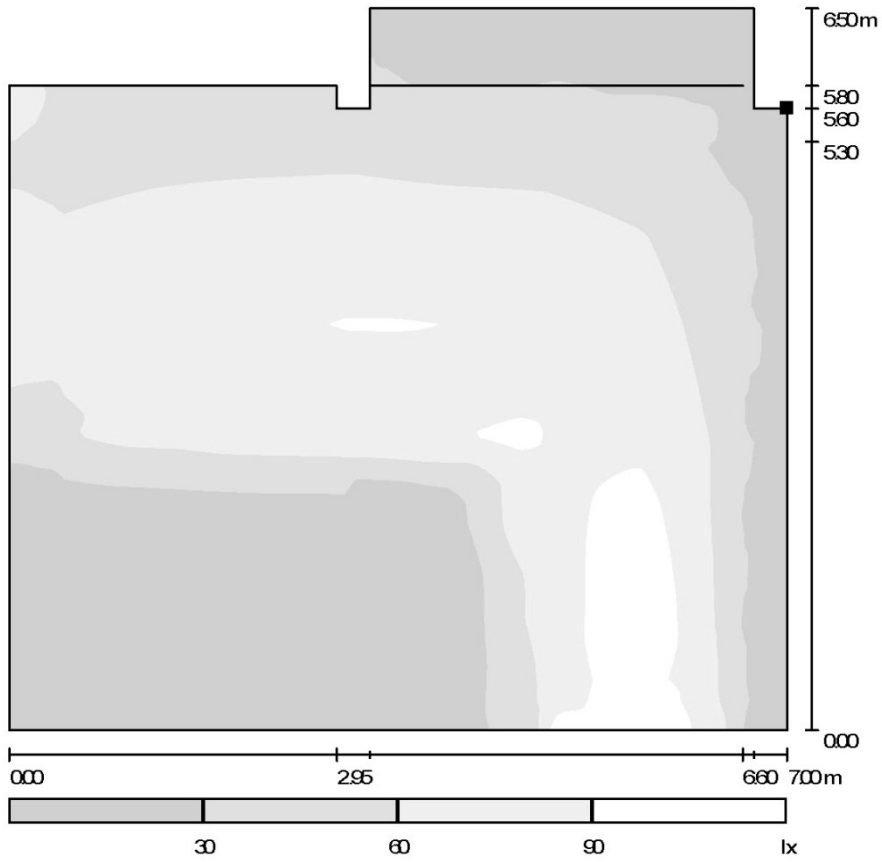

Position of surface in room:
 Marked point:
 (7.000 m, 11.500 m, 5.600 m)



Scale 1 : 56

Grid: 128 x 128 Points

E_{av} [lx]	E_{min} [lx]	E_{max} [lx]	$u0$	E_{min} / E_{max}
50	2.82	112	0.06	0.03

Wall / Value Chart (E)

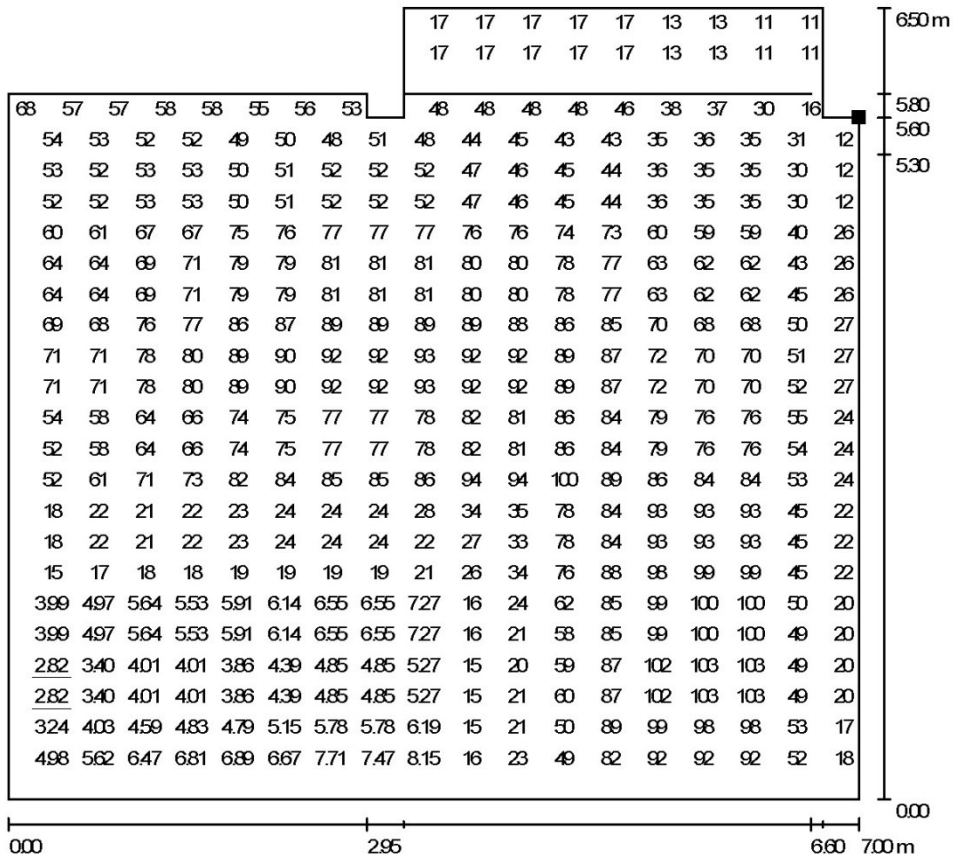

Values in Lux, Scale 1 : 51

Not all calculated values could be displayed.

Position of surface in room:
Marked point:
(7.000 m, 11.500 m, 5.600 m)

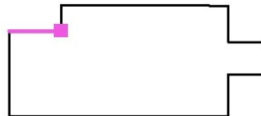

Grid: 128 x 128 Points

E_{av} [lx]	E_{min} [lx]	E_{max} [lx]	u_0	E_{min} / E_{max}
50	2.82	112	0.06	0.03

Wall / Greyscale (E)

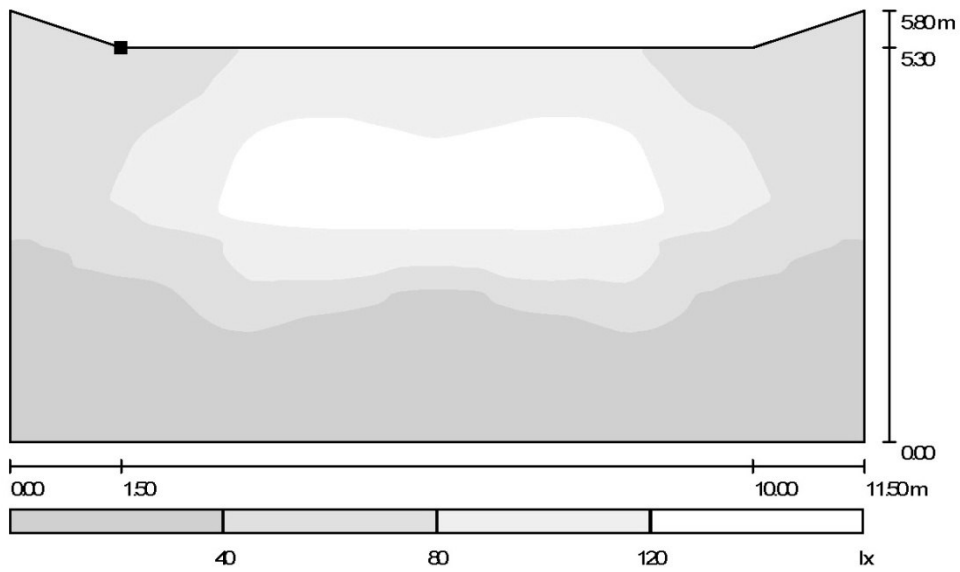

Scale 1 : 83

Position of surface in room:
Marked point:
(0.000 m, 1.500 m, 5.300 m)

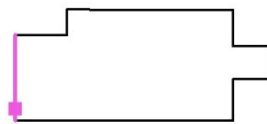

Grid: 128 x 128 Points

E_{av} [lx]	E_{min} [lx]	E_{max} [lx]	$u0$	E_{min} / E_{max}
62	2.47	155	0.04	0.02

Wall / Value Chart (E)

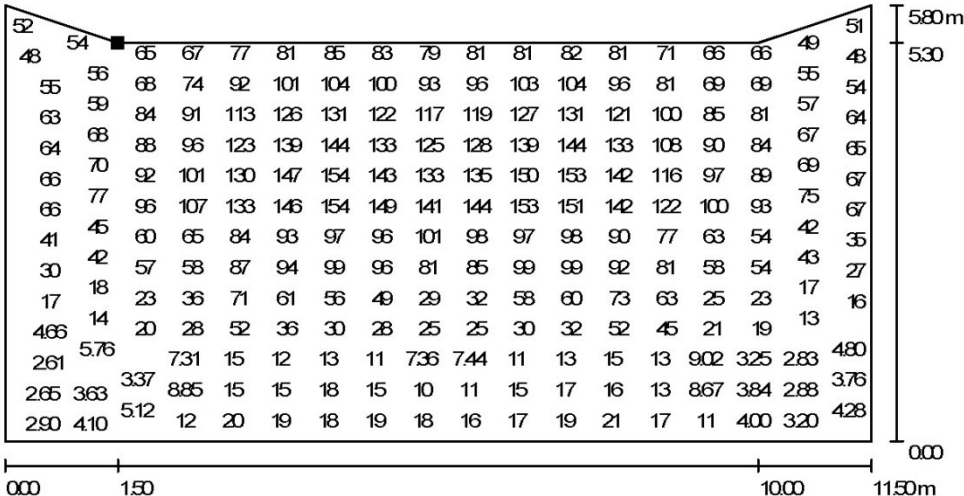

Values in Lux, Scale 1 : 83

Not all calculated values could be displayed.

Position of surface in room:
 Marked point:
 (0.000 m, 1.500 m, 5.300 m)



Grid: 128 x 128 Points

E_{av} [lx]	E_{min} [lx]	E_{max} [lx]	u0	E_{min} / E_{max}
62	2.47	155	0.04	0.02

APPENDIX B

PHOTOMETRIC RESULTS FOR HALOGEN SPOTLIGHTING SYSTEM

OSRAM GmbH 64845SP HALOPAR® 30 mit Kaltlicht-Reflektor 64845SP / Luminaire
Data Sheet



Luminous emittance 1:

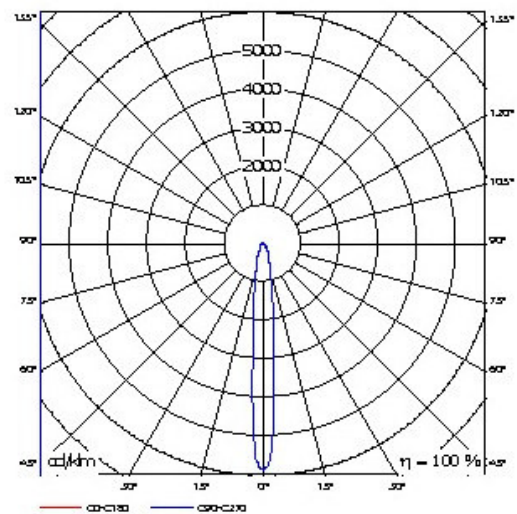

Luminaire classification according to CIE: 94
CIE flux code: 74 90 97 94 100

OSRAM HALOPAR® 20/30

- Wahlweise mit facettiertem Aluminium-Reflektor, der die entstehende Wärme nach vorne abstrahlt.
- Oder mit dekorativem Kaltlichtreflektor, der die Wärmestrahlung im Lichtbündel um bis zu 86% reduziert. Damit sind sie auch zur Beleuchtung wärmeempfindlicher Objekte bestens geeignet.

HALOPAR® ist die halogenstarke Alternative für herkömmliche Reflektorlampen. Sie ist einfach an Netzspannung ohne Trafo zu betreiben. HALOPAR® liefert weißes, brillantes Licht. Insgesamt bietet sie eine bis zu 35% höhere Lichtstärke als herkömmliche Reflektorlampen bzw. 15% Energieersparnis.

- Die HALOPAR®-Lampen sind dimmbar.
- Die Lebensdauer beträgt 2.000 Stunden.
- Der Betrieb in Leuchten ohne Schutzabdeckung ist gemäß IEC 60598-1 erlaubt.
- UV-Filter-Technik (gem. IEC 60432).
- Die Farbtemperatur beträgt ca. 2.900K. &

OSRAM GmbH 64845SP HALOPAR® 30 mit Kaltlicht-Reflektor 64845SP / Cone Diagram

Luminaire: OSRAM GmbH 64845SP HALOPAR® 30 mit Kaltlicht-Reflektor 64845SP
 Lamps: 1 x 75W 230V 10°

Distance [m]	Cone Diameter [m]	Illuminance [lx]
0.5	0.09	E(0°) 30002 E(CD) 5.0° 14983
1.0	0.18	E(0°) 7501 E(CD) 5.0° 3746
1.5	0.26	E(0°) 3334 E(CD) 5.0° 1665
2.0	0.35	E(0°) 1875 E(CD) 5.0° 936
2.5	0.44	E(0°) 1200 E(CD) 5.0° 599
3.0	0.53	E(0°) 833 E(CD) 5.0° 416
Half-value Angle	10.0°	

Room with Osram 64845SP Halopar 30 Coldlight / Summary

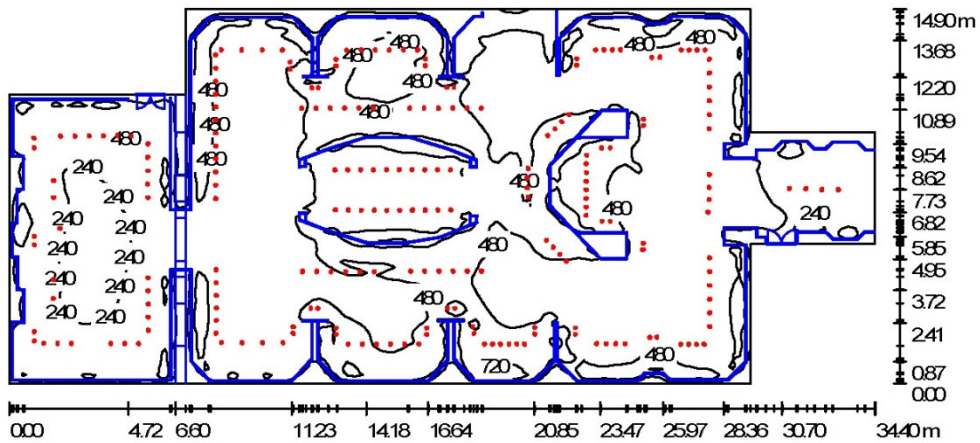

Height of Room: 6.500 m

Values in Lux, Scale 1:246

Surface	ρ [%]	E_{av} [lx]	E_{min} [lx]	E_{max} [lx]	u_0
Workplane	/	402	26	1185	0.06
Floor	68	362	20	834	0.05

Workplane:

Height: 0.760 m
Grid: 128 x 128 Points

Luminaire Parts List

No.	Pieces	Designation (Correction Factor)	Φ [lm]	P [W]
1	217	OSRAM GmbH 64845SP HALOPAR® 30 mit Kaltlicht-Reflektor 64845SP (1.000)	1279	75
total:			277543	16275

Specific connected load: $37.25 \text{ W/m}^2 = 9.26 \text{ W/m}^2/100 \text{ lx}$ (Area: 436.93 m^2)

Calculation surfaces (results overview)

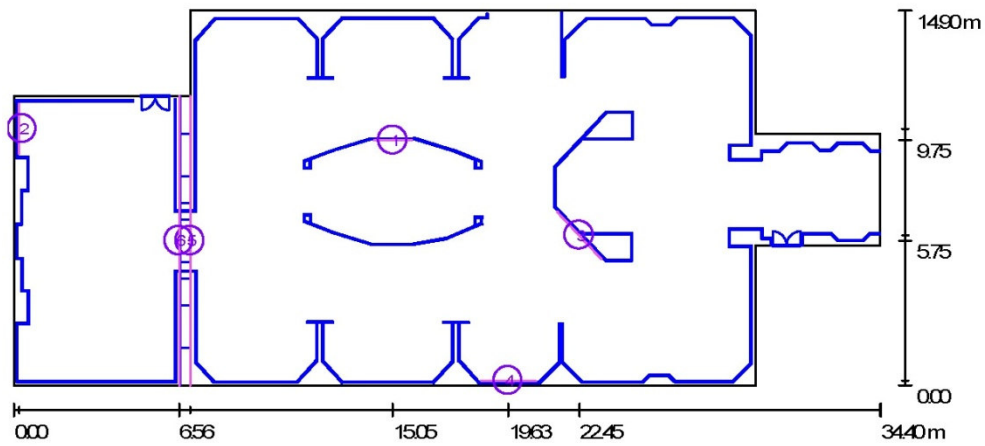

Scale 1 : 246

Calculation Surface List

No.	Designation	Type	Grid	E_{av} [lx]	E_{min} [lx]	E_{max} [lx]	u0	E_{min} / E_{max}
1	Calculation Surface 1	perpendicular	32 x 32	640	512	882	0.80	0.58
2	Calculation Surface 2	perpendicular	32 x 32	315	243	413	0.77	0.59
3	Calculation Surface 3	perpendicular	32 x 32	436	345	543	0.79	0.64
4	Calculation Surface 4	perpendicular	32 x 32	527	449	638	0.85	0.70
5	Calculation Surface 5	perpendicular	128 x 64	240	13	472	0.05	0.03
6	Calculation Surface 6	perpendicular	128 x 64	168	8.25	339	0.05	0.02

Summary of Results

Type	Quantity	Average [lx]	Min [lx]	Max [lx]	u0	E_{min} / E_{max}
perpendicular	6	242	8.25	882	0.03	0.01

Workplane / Isolines (E)

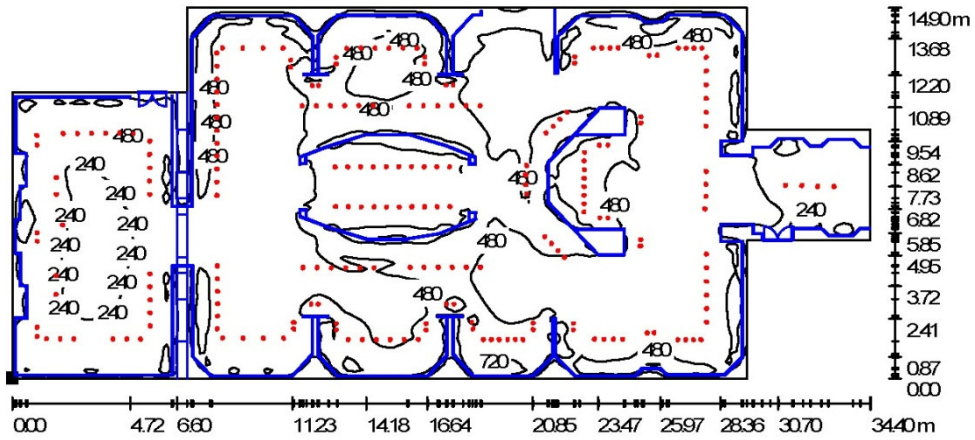

Values in Lux, Scale 1 : 246

Position of surface in room:
Marked point:
(0.000 m, 0.000 m, 0.760 m)



Grid: 128 x 128 Points

E_{av} [lx]
402

E_{min} [lx]
26

E_{max} [lx]
1185

u_0
0.06

E_{min} / E_{max}
0.02

Workplane / Greyscale (E)

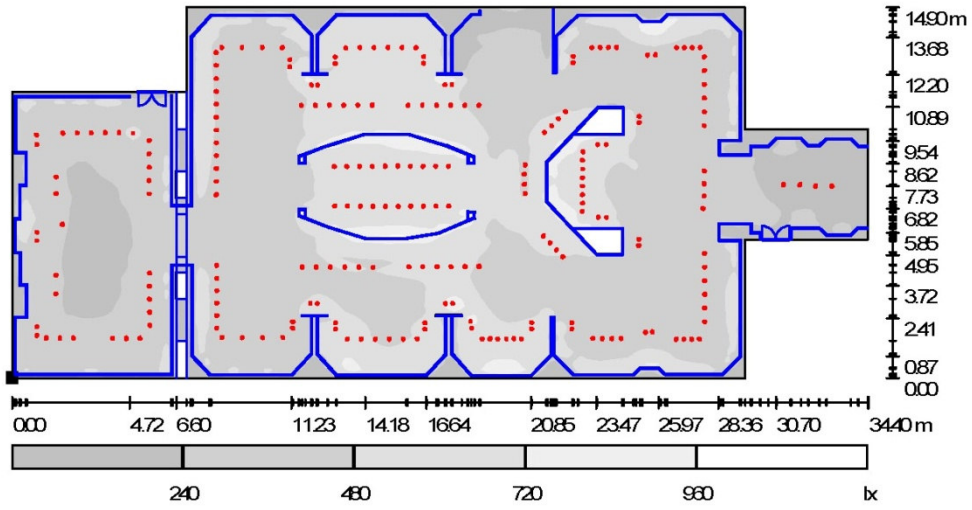

Scale 1 : 246

Position of surface in room:
Marked point:
(0.000 m, 0.000 m, 0.760 m)



Grid: 128 x 128 Points

E_{av} [lx]	E_{min} [lx]	E_{max} [lx]	$u0$	E_{min} / E_{max}
402	26	1185	0.06	0.02

Workplane / Value Chart (E)

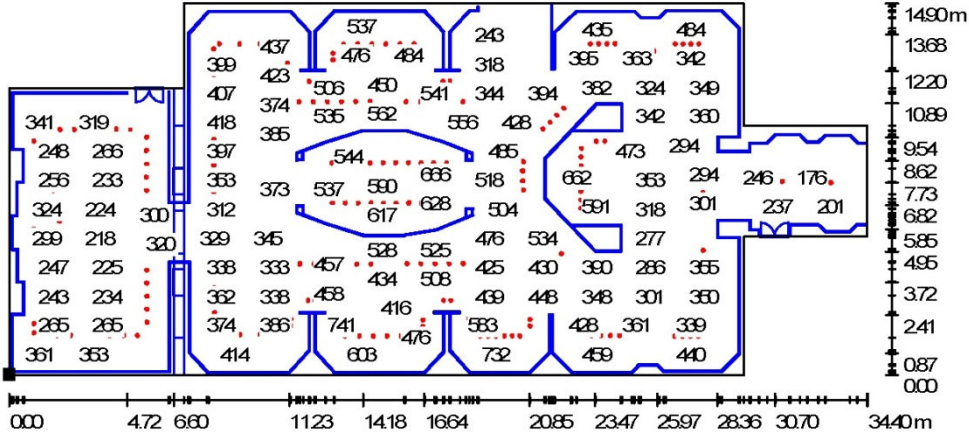

Values in Lux, Scale 1 : 246

Not all calculated values could be displayed.

Position of surface in room:
Marked point:
(0.000 m, 0.000 m, 0.760 m)



Grid: 128 x 128 Points

E_{av} [lx]	E_{min} [lx]	E_{max} [lx]	u_0	E_{min} / E_{max}
402	26	1185	0.06	0.02

Calculation Surface 1 / Greyscale

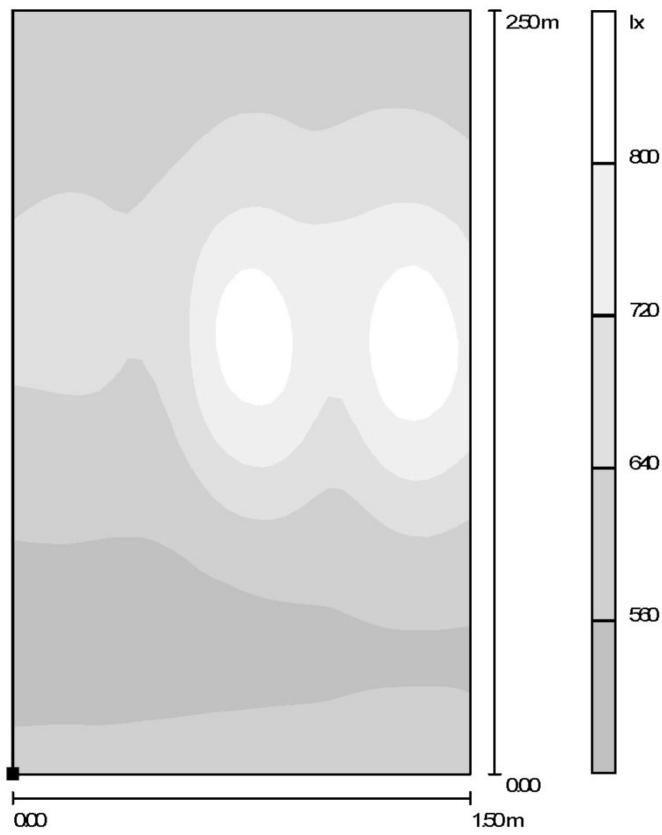

Position of surface in room:
 Marked point:
 (14.300 m, 9.750 m, 0.000 m)

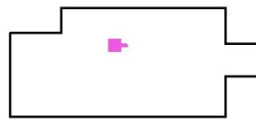

Scale 1 : 20

Grid: 32 x 32 Points

E_{av} [lx]
640

E_{min} [lx]
512

E_{max} [lx]
882

u_0
0.80

E_{min} / E_{max}
0.58

Calculation Surface 1 / Value Chart

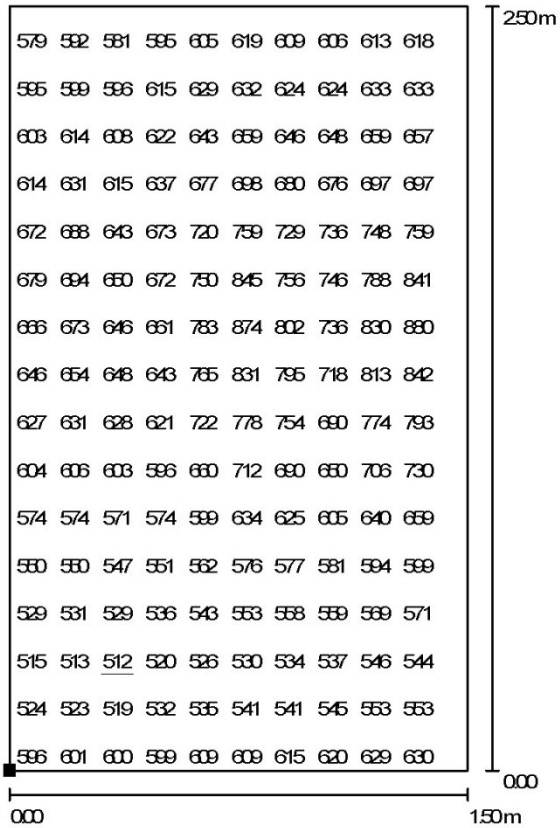

Values in Lux, Scale 1 : 20

Not all calculated values could be displayed.

Position of surface in room:
Marked point:
(14.300 m, 9.750 m, 0.000 m)

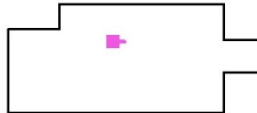

Grid: 32 x 32 Points

E_{av} [lx]
640

E_{min} [lx]
512

E_{max} [lx]
882

u_0
0.80

E_{min} / E_{max}
0.58

Calculation Surface 2 / Isolines

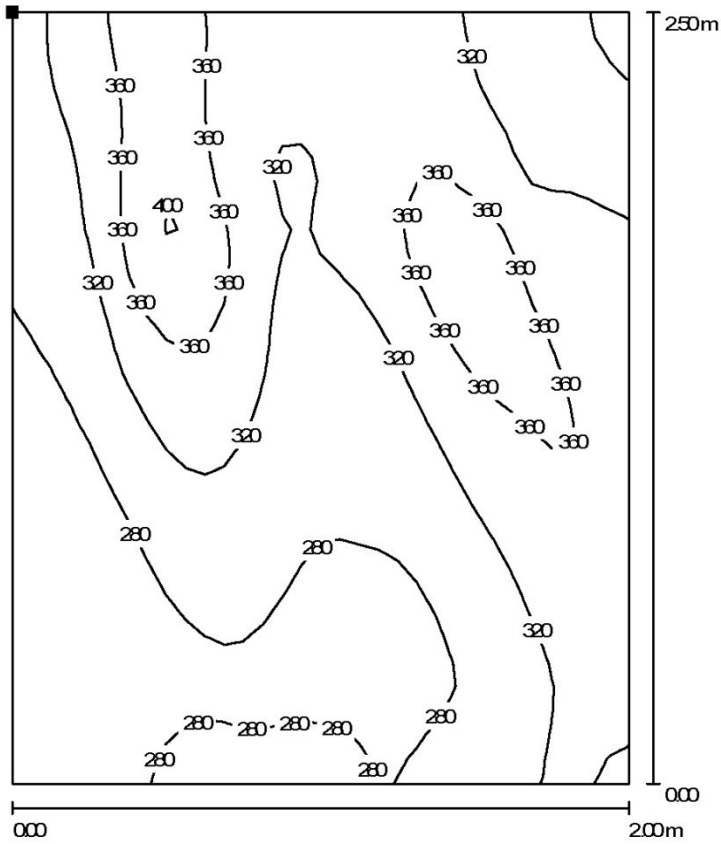

Position of surface in room:
 Marked point:
 (0.205 m, 9.200 m, 2.500 m)

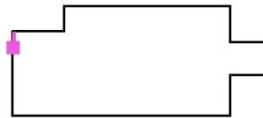

Values in Lux, Scale 1 : 20

Grid: 32 x 32 Points

E_{av} [lx]	E_{min} [lx]	E_{max} [lx]	$u0$	E_{min} / E_{max}
315	243	413	0.77	0.59

Calculation Surface 2 / Greyscale

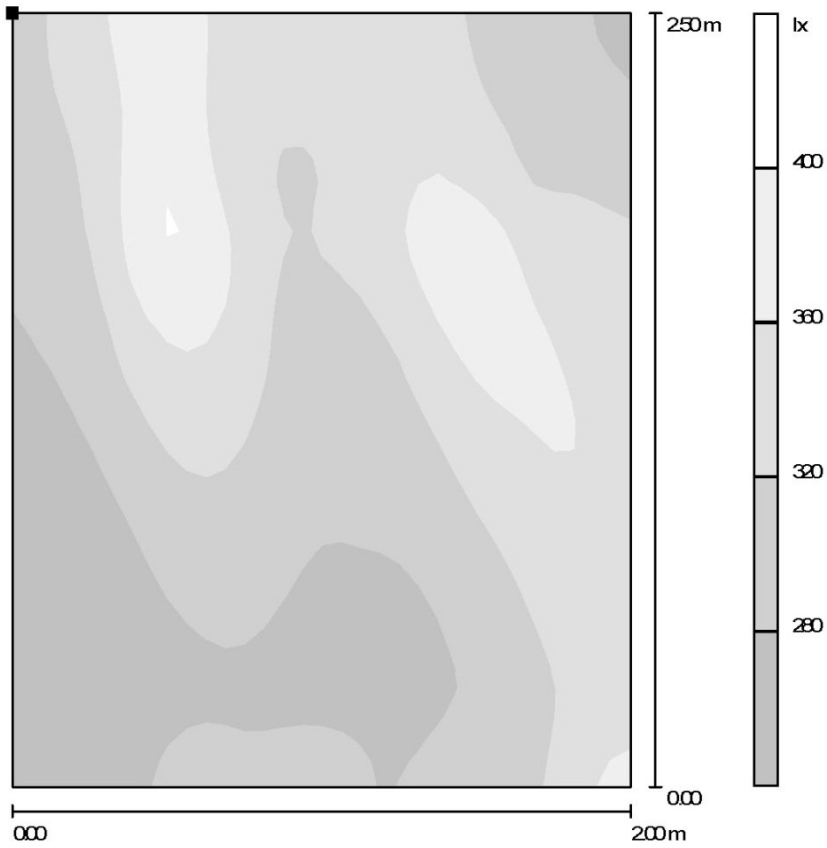

Position of surface in room:
 Marked point:
 (0.205 m, 9.200 m, 2.500 m)



Scale 1 : 20

Grid: 32 x 32 Points

E_{av} [lx]
315

E_{min} [lx]
243

E_{max} [lx]
413

u_0
0.77

E_{min} / E_{max}
0.59

Calculation Surface 2 / Value Chart

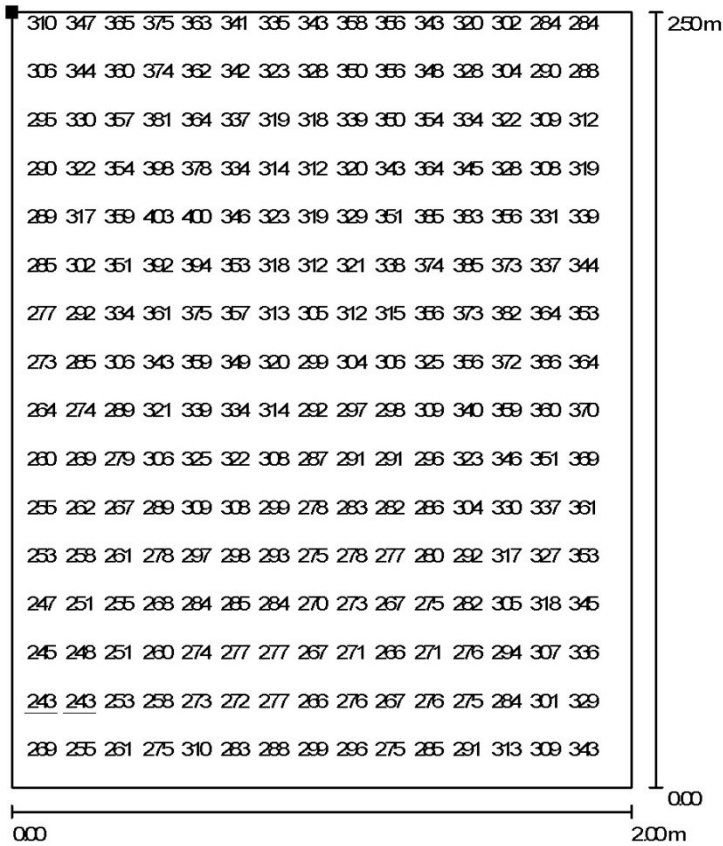

Not all calculated values could be displayed.

Values in Lux, Scale 1 : 20

Position of surface in room:
Marked point:
(0.205 m, 9.200 m, 2.500 m)



Grid: 32 x 32 Points

E_{av} [lx]
315

E_{min} [lx]
243

E_{max} [lx]
413

u_0
0.77

E_{min} / E_{max}
0.59

Calculation Surface 3 / Isolines

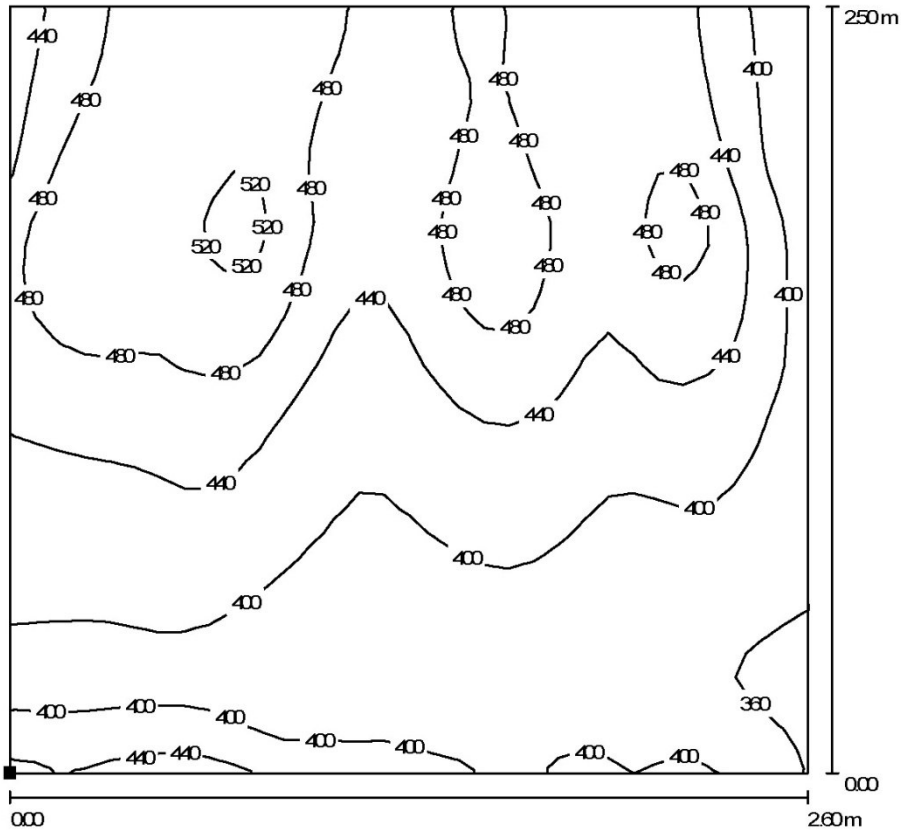

Values in Lux, Scale 1 : 20

Position of surface in room:
 Marked point:
 (21.558 m, 6.911 m, 0.000 m)

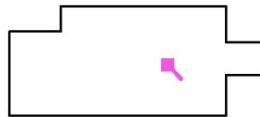

Grid: 32 x 32 Points

E_{av} [lx]	E_{min} [lx]	E_{max} [lx]	$u0$	E_{min} / E_{max}
436	345	543	0.79	0.64

Calculation Surface 3 / Greyscale

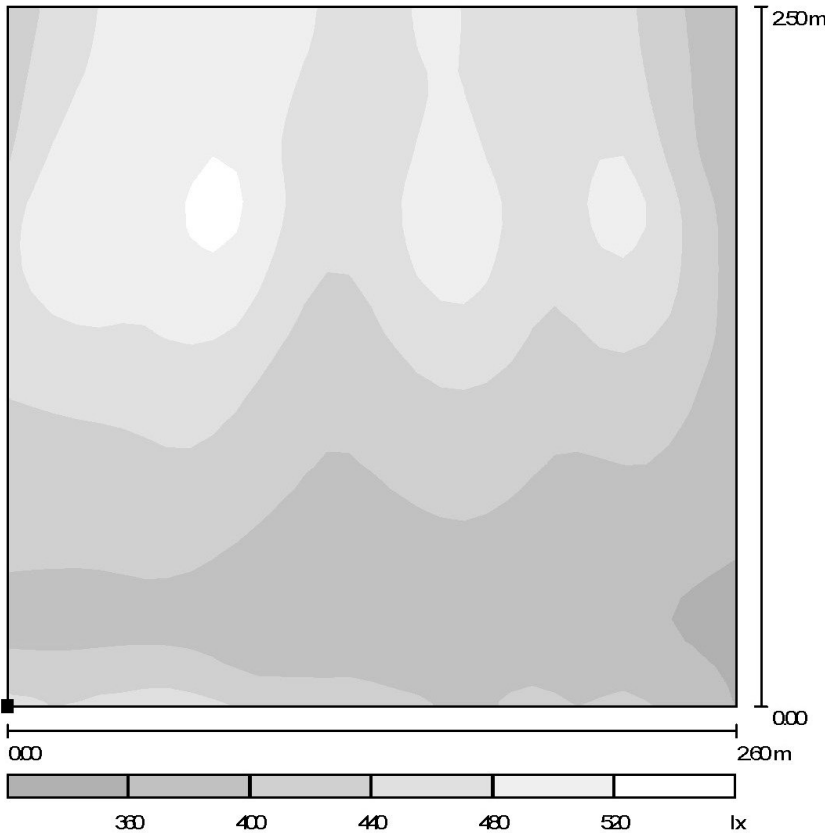

Position of surface in room:
 Marked point:
 (21.558 m, 6.911 m, 0.000 m)



Scale 1 : 22

Grid: 32 x 32 Points

E_{av} [lx]	E_{min} [lx]	E_{max} [lx]	$u0$	E_{min} / E_{max}
436	345	543	0.79	0.64

Calculation Surface 3 / Value Chart

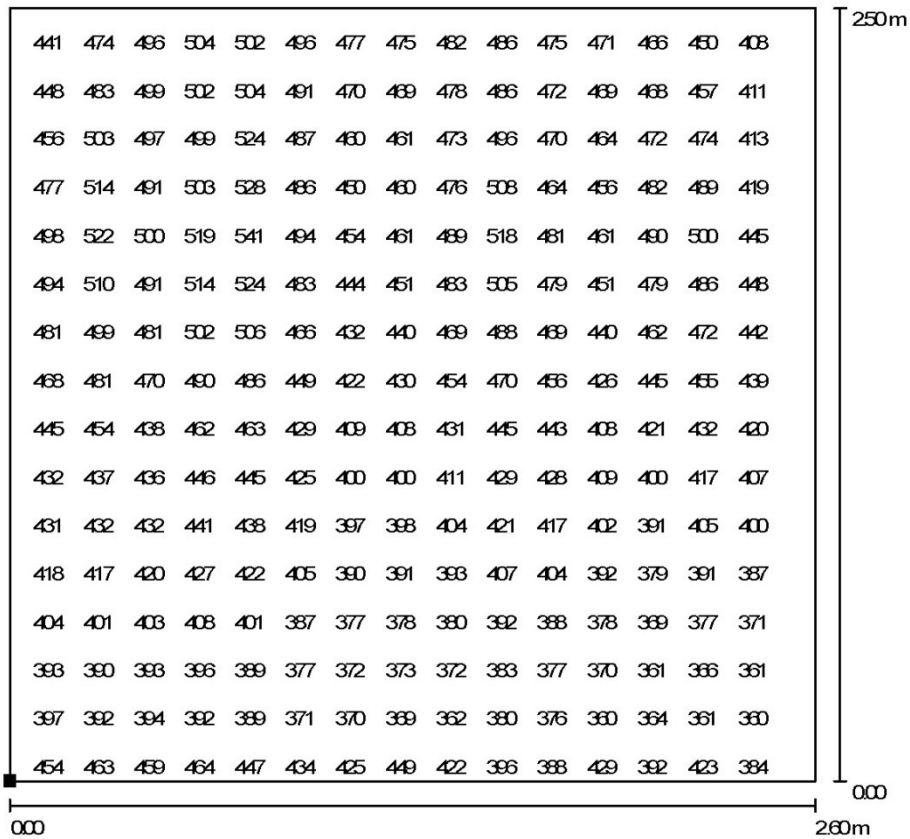

Values in Lux, Scale 1 : 20

Not all calculated values could be displayed.

Position of surface in room:
Marked point:
(21.558 m, 6.911 m, 0.000 m)



Grid: 32 x 32 Points

E_{av} [lx]	E_{min} [lx]	E_{max} [lx]	u_0	E_{min} / E_{max}
436	345	543	0.79	0.64

Room with Osram 64845SP Halopar 30 Coldlight / Calculation Surface 4 / Isolines (E, Perpendicular)

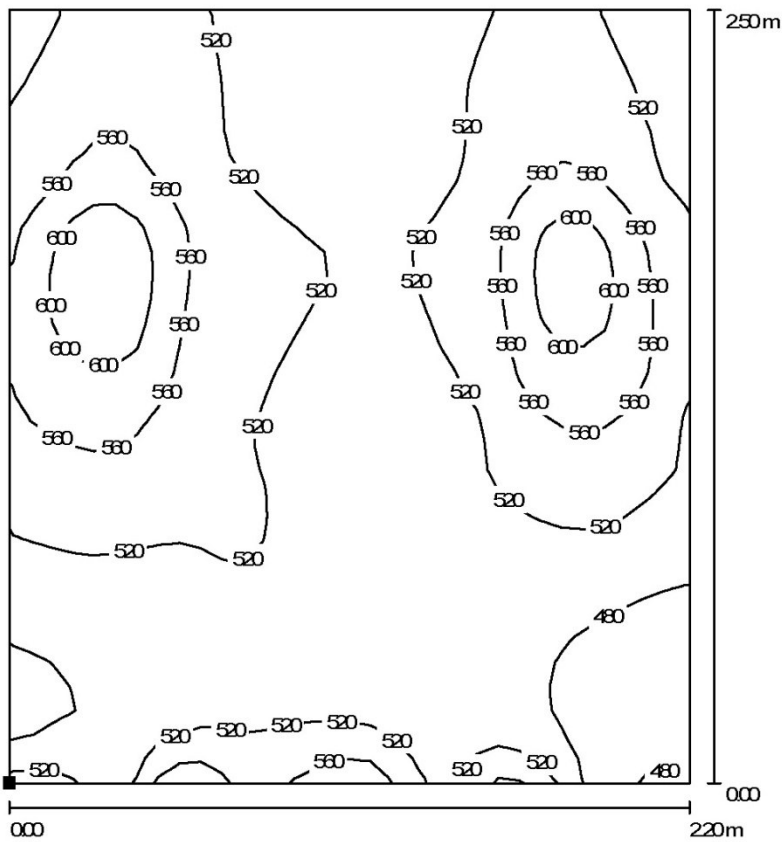

Values in Lux, Scale 1 : 20

Position of surface in room:
Marked point:
(20.730 m, 0.175 m, 0.000 m)



Grid: 32 x 32 Points

E_{av} [lx]	E_{min} [lx]	E_{max} [lx]	u_0	E_{min} / E_{max}
527	449	638	0.85	0.70

Calculation Surface 4 / Greyscale

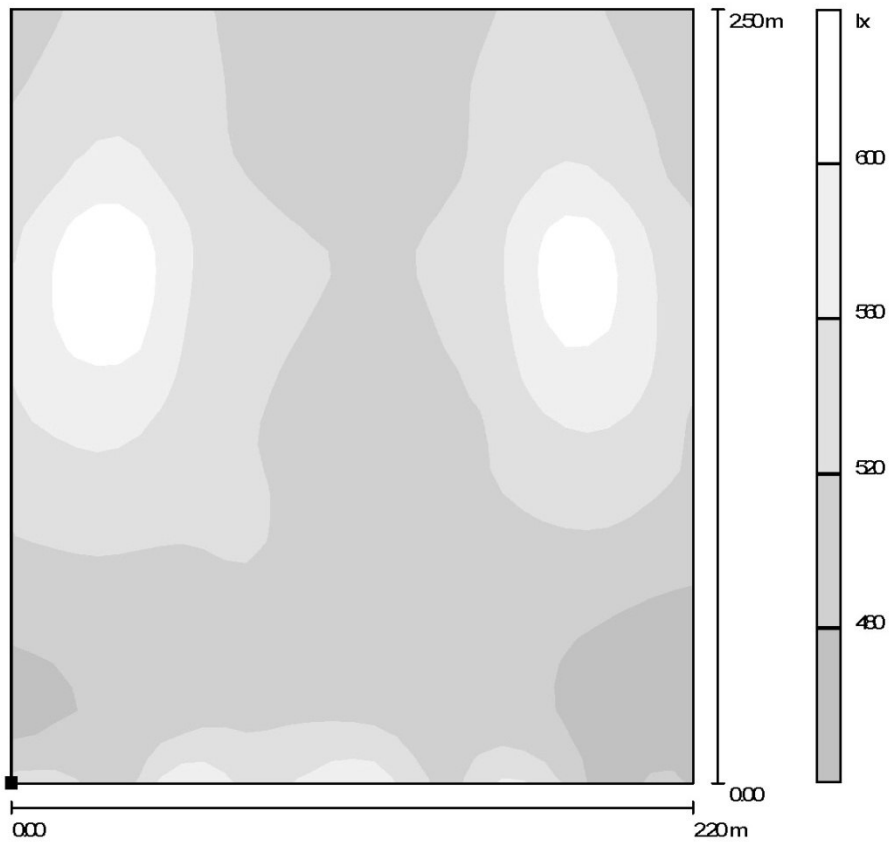

Position of surface in room:
 Marked point:
 (20.730 m, 0.175 m, 0.000 m)



Scale 1 : 20

Grid: 32 x 32 Points

E_{av} [lx]	E_{min} [lx]	E_{max} [lx]	u_0	E_{min} / E_{max}
527	449	638	0.85	0.70

Calculation Surface 4 / Value Chart

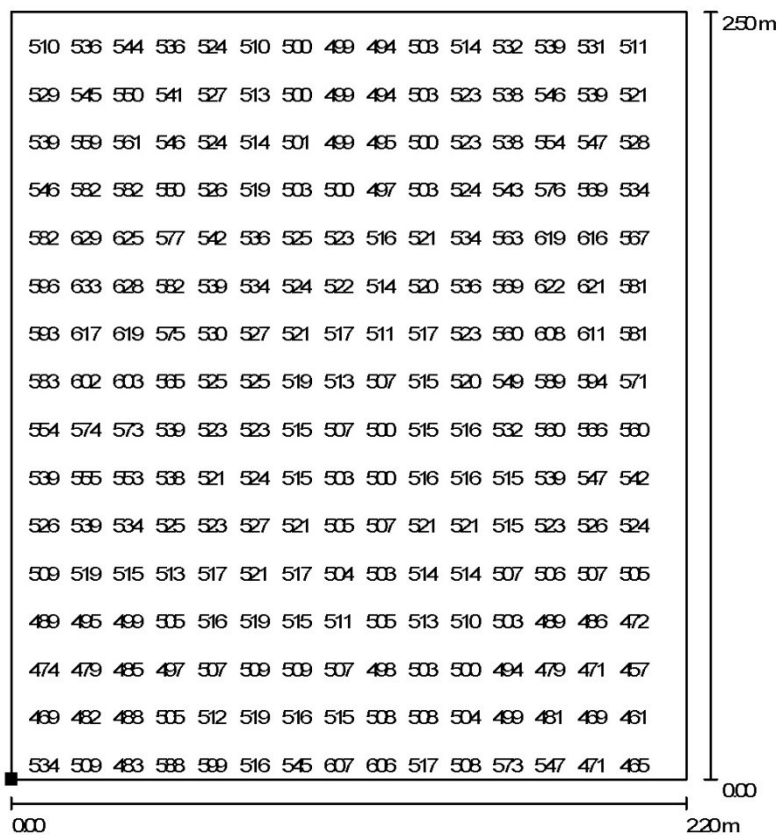

Values in Lux, Scale 1 : 20

Not all calculated values could be displayed.

Position of surface in room:
Marked point:
(20.730 m, 0.175 m, 0.000 m)

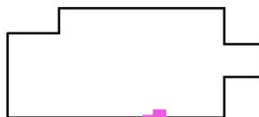

Grid: 32 x 32 Points

E_{av} [lx]
527

E_{min} [lx]
449

E_{max} [lx]
638

u_0
0.85

E_{min} / E_{max}
0.70

Calculation Surface 5 / Isolines

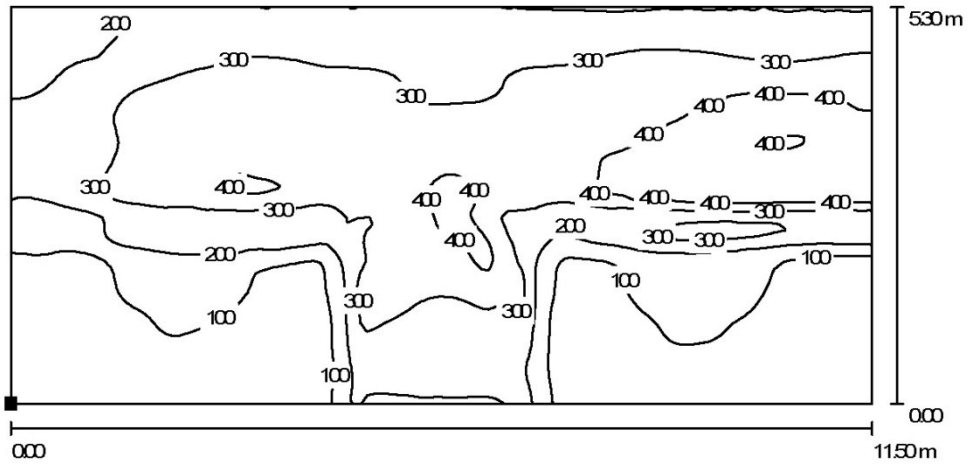

Values in Lux, Scale 1 : 83

Position of surface in room:
Marked point:
(7.001 m, 0.000 m, 0.000 m)



Grid: 128 x 64 Points

E_{av} [lx]	E_{min} [lx]	E_{max} [lx]	u_0	E_{min} / E_{max}
240	13	472	0.05	0.03

Calculation Surface 5 / Greyscale

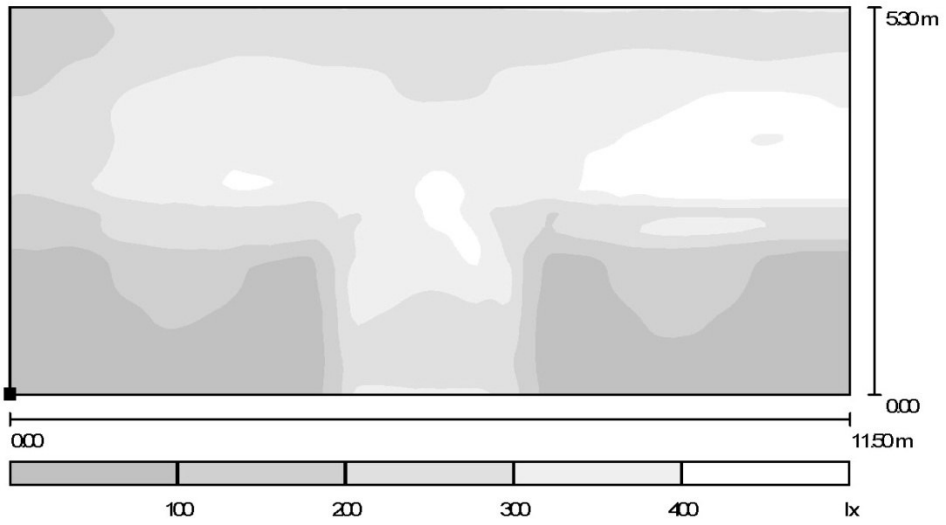

Position of surface in room:
Marked point:
(7.001 m, 0.000 m, 0.000 m)



Scale 1 : 83

Grid: 128 x 64 Points

E_{av} [lx]	E_{min} [lx]	E_{max} [lx]	$u0$	E_{min} / E_{max}
240	13	472	0.05	0.03

Calculation Surface 5 / Value Chart

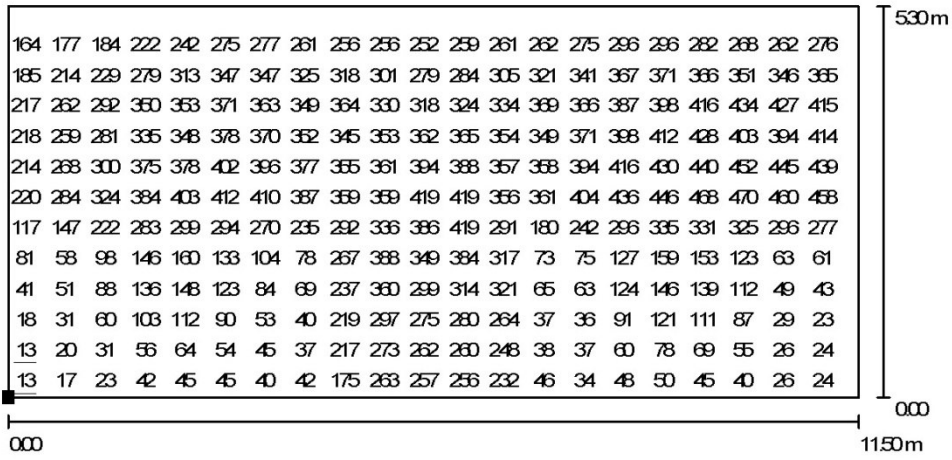

Values in Lux, Scale 1 : 83

Not all calculated values could be displayed.

Position of surface in room:
Marked point:
(7.001 m, 0.000 m, 0.000 m)



Grid: 128 x 64 Points

E_{av} [lx]
240

E_{min} [lx]
13

E_{max} [lx]
472

$u0$
0.05

E_{min} / E_{max}
0.03

Calculation Surface 6 / Isolines

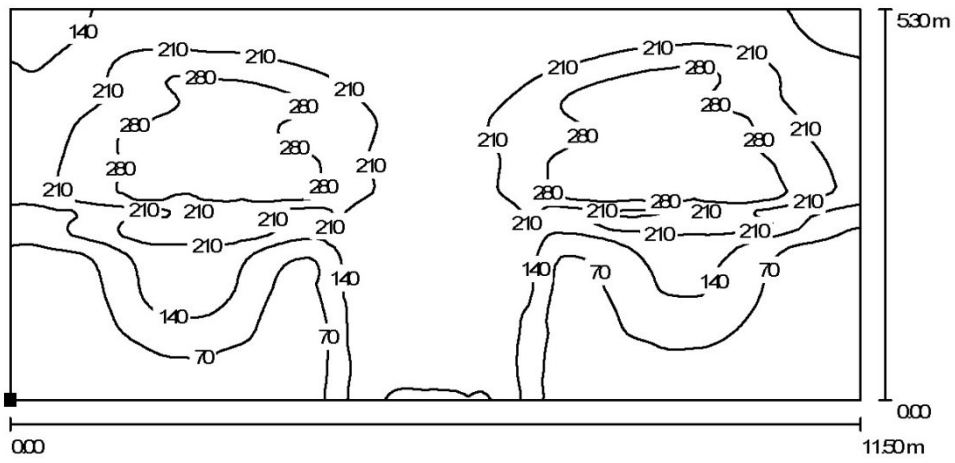

Values in Lux, Scale 1 : 83

Position of surface in room:
Marked point:
(6.559 m, 11.500 m, 0.000 m)

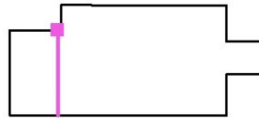

Grid: 128 x 64 Points

E_{av} [lx]
168

E_{min} [lx]
8.25

E_{max} [lx]
339

u_0
0.05

E_{min} / E_{max}
0.02

Calculation Surface 6 / Greyscale

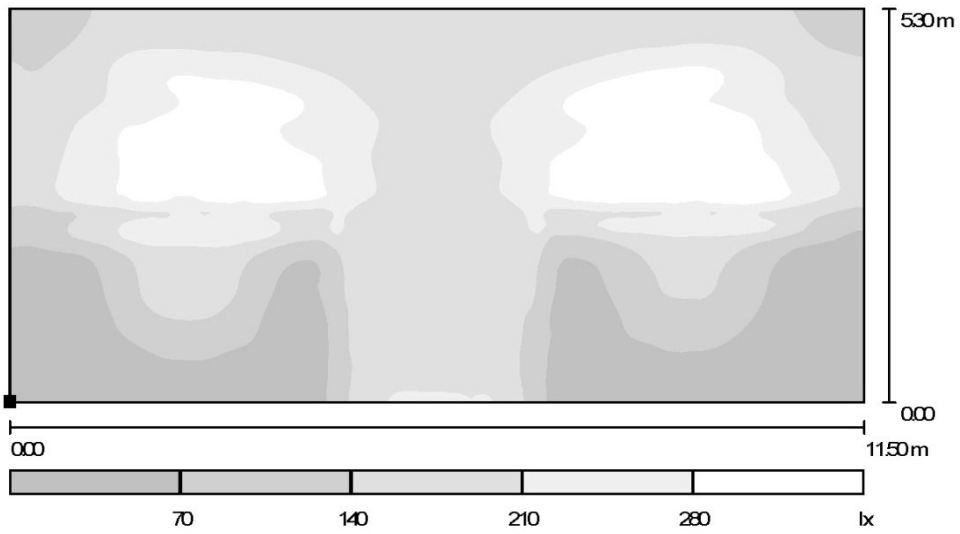

Position of surface in room:
 Marked point:
 (6.559 m, 11.500 m, 0.000 m)



Scale 1 : 83

Grid: 128 x 64 Points

E_{av} [lx]
168

E_{min} [lx]
8.25

E_{max} [lx]
339

$u0$
0.05

E_{min} / E_{max}
0.02

Calculation Surface 6 / Value Chart

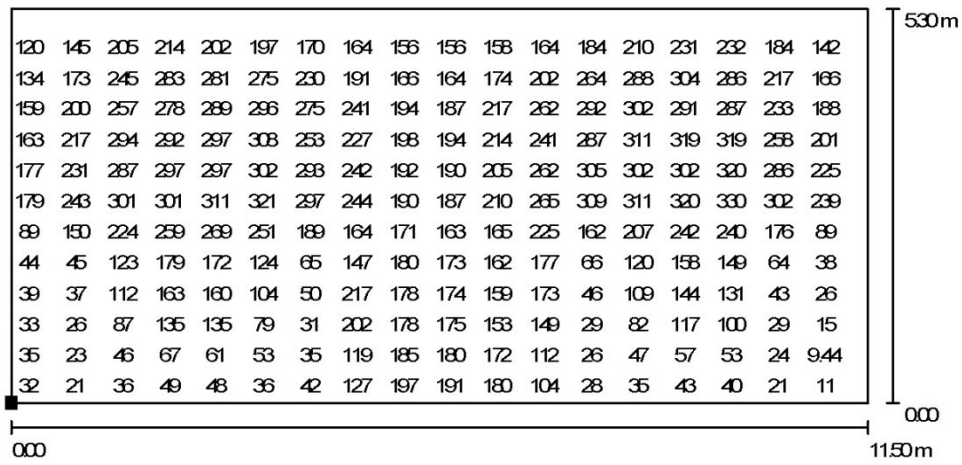

Values in Lux, Scale 1 : 83

Not all calculated values could be displayed.

Position of surface in room:
Marked point:
(6.559 m, 11.500 m, 0.000 m)

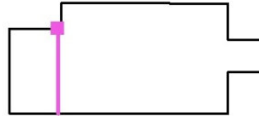

Grid: 128 x 64 Points

E_{av} [lx]
168

E_{min} [lx]
8.25

E_{max} [lx]
339

u_0
0.05

E_{min} / E_{max}
0.02

Floor / Isolines (E)

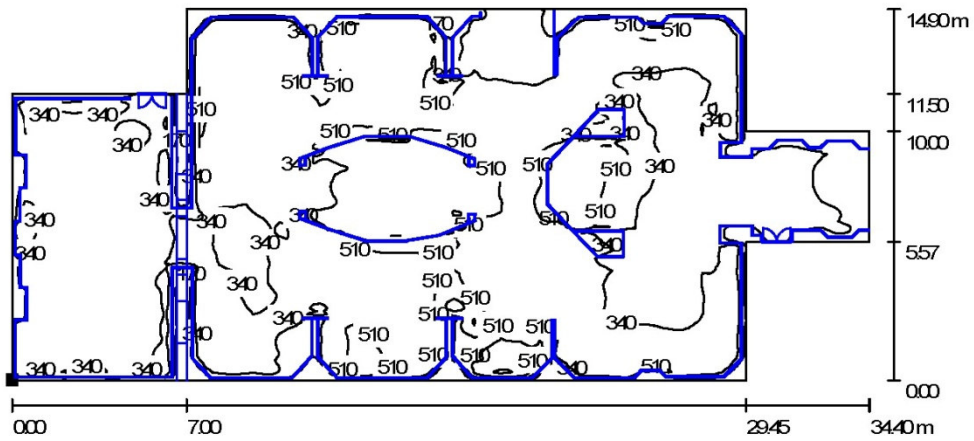

Values in Lux, Scale 1 : 246

Position of surface in room:
Marked point:
(0.000 m, 0.000 m, 0.000 m)



Grid: 128 x 128 Points

E_{av} [lx]	E_{min} [lx]	E_{max} [lx]	$u0$	E_{min} / E_{max}
362	20	834	0.05	0.02

Floor / Greyscale (E)

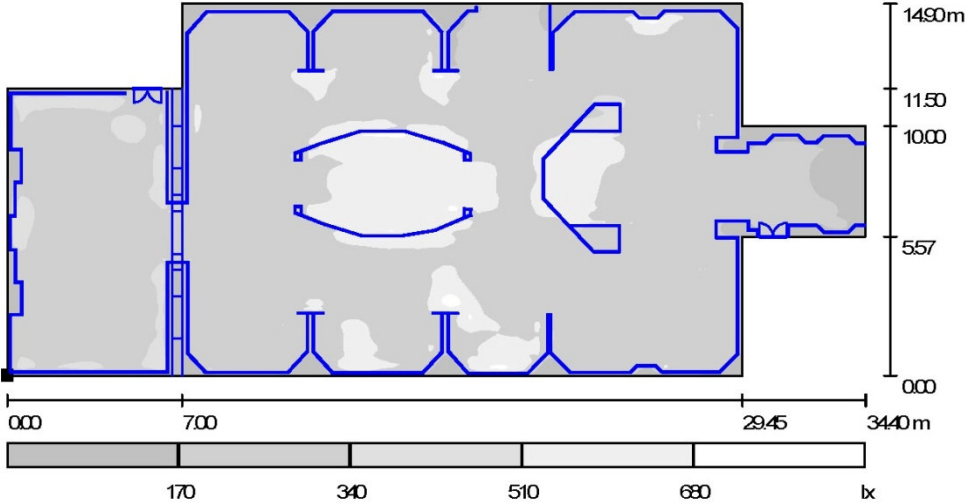

Scale 1 : 246

Position of surface in room:
Marked point:
(0.000 m, 0.000 m, 0.000 m)



Grid: 128 x 128 Points

E_{av} [lx]	E_{min} [lx]	E_{max} [lx]	u_0	E_{min} / E_{max}
362	20	834	0.05	0.02

Floor / Value Chart (E)

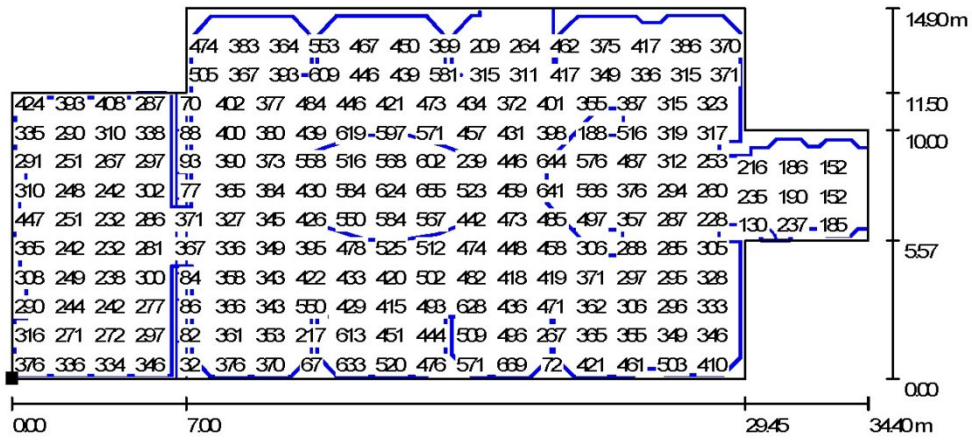

Values in Lux, Scale 1 : 246

Not all calculated values could be displayed.

Position of surface in room:
Marked point:
(0.000 m, 0.000 m, 0.000 m)



Grid: 128 x 128 Points

E_{av} [lx]	E_{min} [lx]	E_{max} [lx]	u_0	E_{min} / E_{max}
362	20	834	0.05	0.02

Ceiling / Greyscale (E)

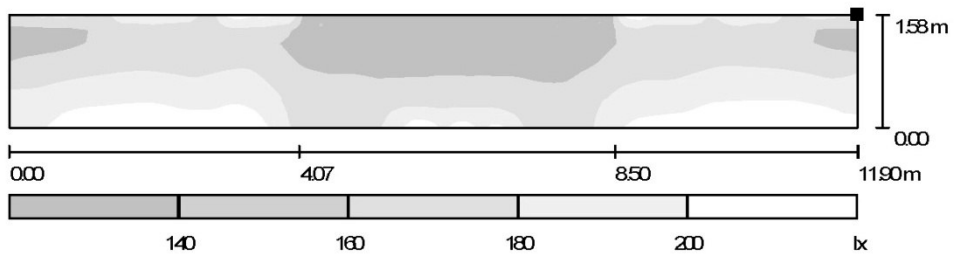

Position of surface in room:
 Marked point:
 (29.450 m, 13.400 m, 5.800 m)

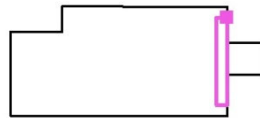

Scale 1 : 86

Grid: 128 x 128 Points

E_{av} [lx]	E_{min} [lx]	E_{max} [lx]	$u0$	E_{min} / E_{max}
173	135	219	0.78	0.62

Ceiling / Value Chart (E)

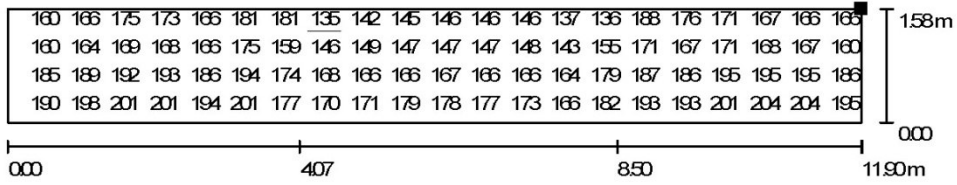

Values in Lux, Scale 1 : 86

Not all calculated values could be displayed.

Position of surface in room:
Marked point:
(29.450 m, 13.400 m, 5.800 m)

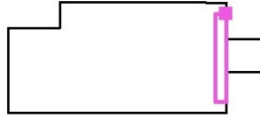

Grid: 128 x 128 Points

E_{av} [lx]	E_{min} [lx]	E_{max} [lx]	$u0$	E_{min} / E_{max}
173	135	219	0.78	0.62

Ceiling / Greyscale (E)

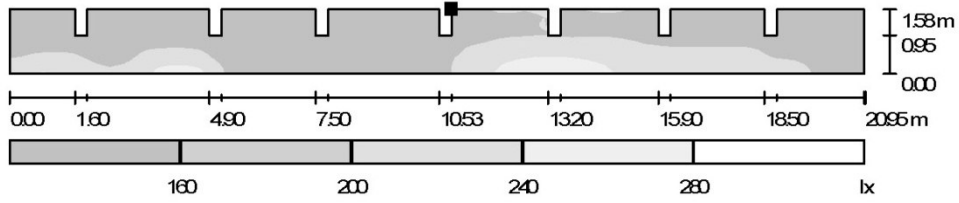

Position of surface in room:
 Marked point:
 (17.120 m, 14.900 m, 5.800 m)



Scale 1 : 150

Grid: 128 x 128 Points

E_{av} [lx]	E_{min} [lx]	E_{max} [lx]	u0	E_{min} / E_{max}
186	120	285	0.65	0.42

Ceiling / Value Chart (E)

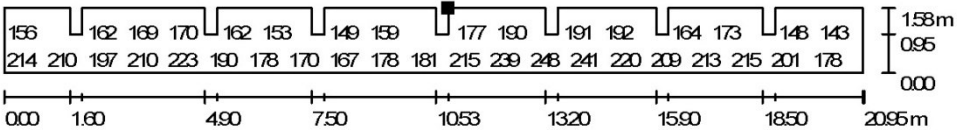

Values in Lux, Scale 1 : 150

Not all calculated values could be displayed.

Position of surface in room:
Marked point:
(17.120 m, 14.900 m, 5.800 m)



Grid: 128 x 128 Points

E_{av} [lx]	E_{min} [lx]	E_{max} [lx]	u0	E_{min} / E_{max}
186	120	285	0.65	0.42

Ceiling / Greyscale (E)

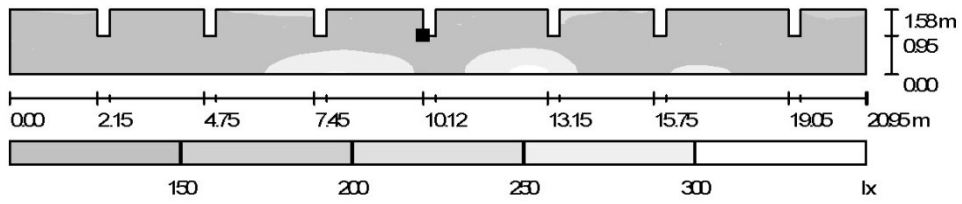

Position of surface in room:
Marked point:
(17.120 m, 0.600 m, 5.600 m)



Scale 1 : 150

Grid: 128 x 128 Points

E_{av} [lx]	E_{min} [lx]	E_{max} [lx]	u0	E_{min} / E_{max}
204	115	342	0.56	0.34

Ceiling / Value Chart (E)

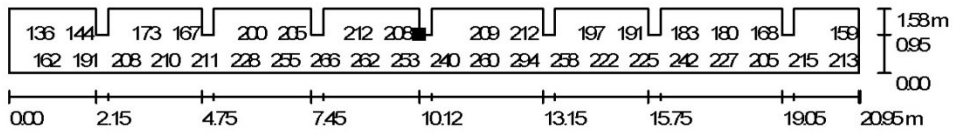

Values in Lux, Scale 1 : 150

Not all calculated values could be displayed.

Position of surface in room:
Marked point:
(17.120 m, 0.600 m, 5.600 m)



Grid: 128 x 128 Points

E_{av} [lx]	E_{min} [lx]	E_{max} [lx]	u0	E_{min} / E_{max}
204	115	342	0.56	0.34

Ceiling / Isolines (E)

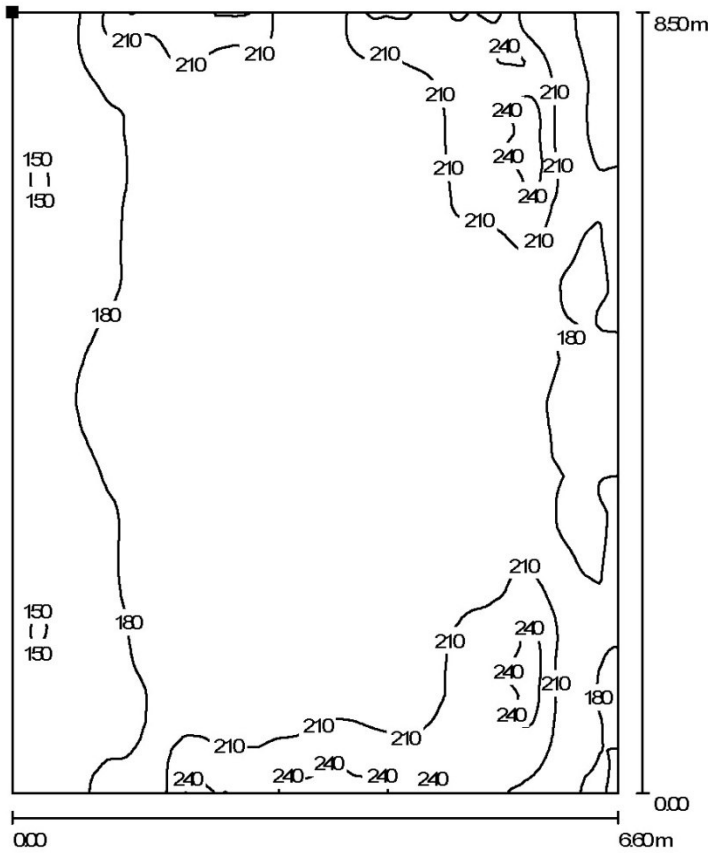

Position of surface in room:
Marked point:
(0.000 m, 1.500 m, 5.300 m)



Values in Lux, Scale 1 : 67

Grid: 128 x 128 Points

E_{av} [lx]
193

E_{min} [lx]
146

E_{max} [lx]
269

$u0$
0.75

E_{min} / E_{max}
0.54

Ceiling / Greyscale (E)

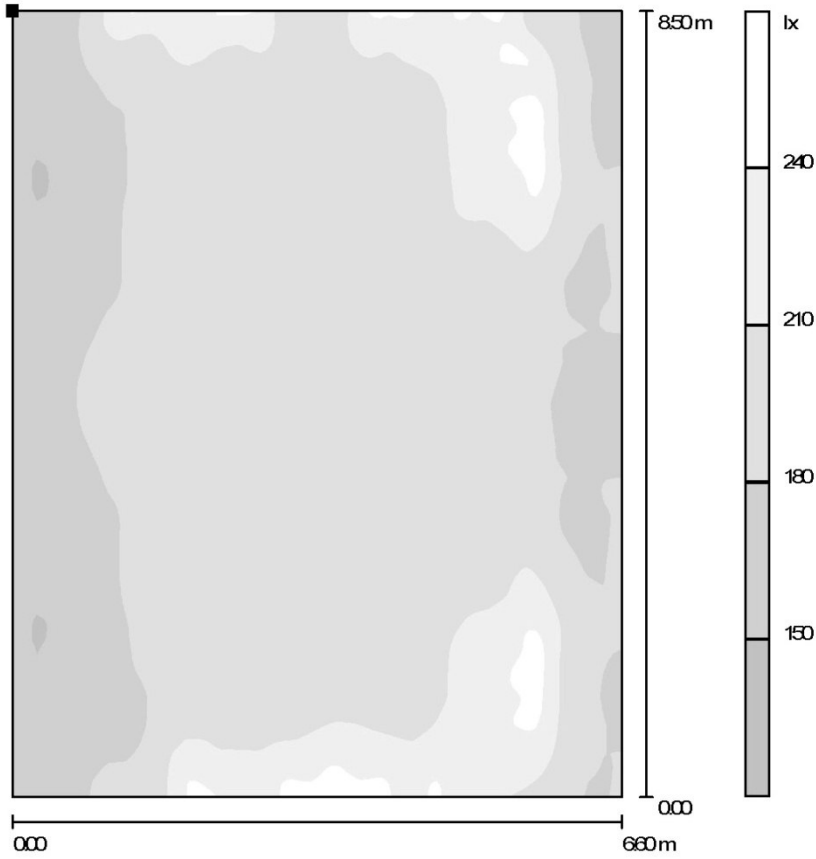

Position of surface in room:
Marked point:
(0.000 m, 1.500 m, 5.300 m)



Scale 1 : 67

Grid: 128 x 128 Points

E_{av} [lx]
193

E_{min} [lx]
146

E_{max} [lx]
269

u_0
0.75

E_{min} / E_{max}
0.54

Ceiling / Value Chart (E)

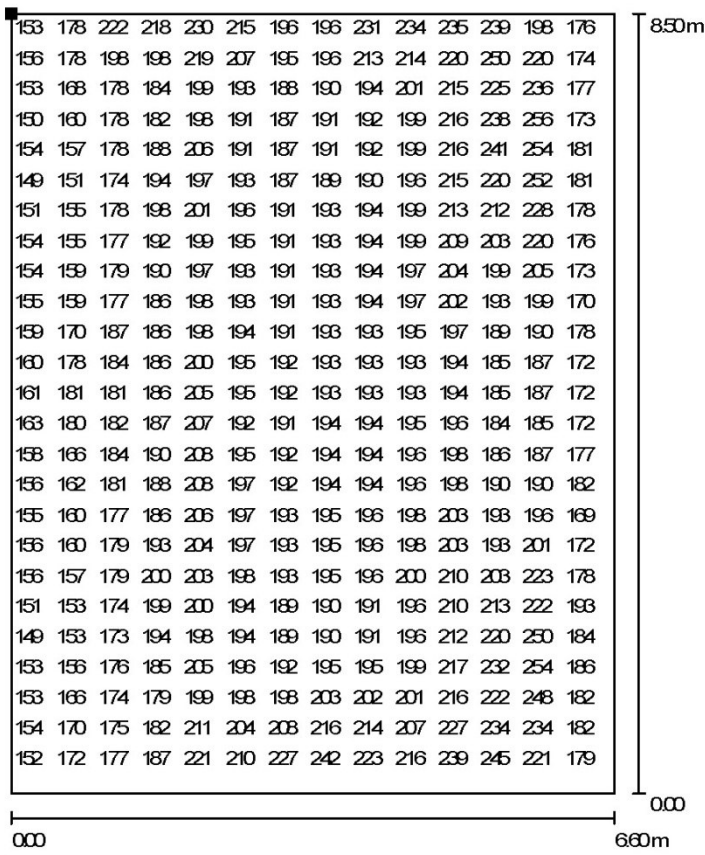

Not all calculated values could be displayed.

Values in Lux, Scale 1 : 67

Position of surface in room:
Marked point:
(0.000 m, 1.500 m, 5.300 m)



Grid: 128 x 128 Points

E_{av} [lx]
193

E_{min} [lx]
146

E_{max} [lx]
269

$u0$
0.75

E_{min} / E_{max}
0.54

Ceiling / Greyscale (E)

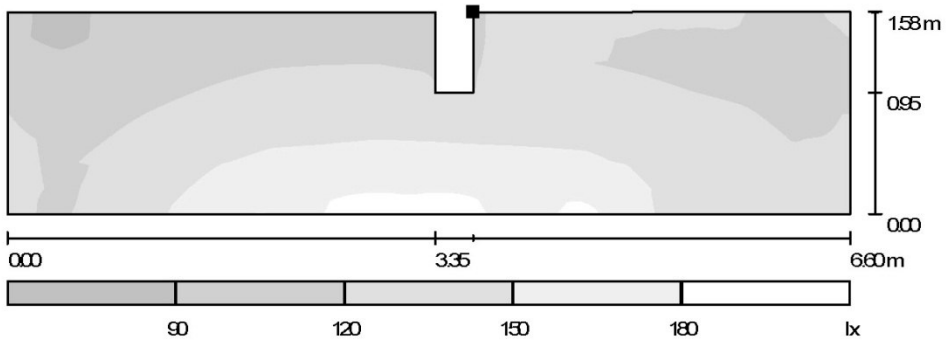

Position of surface in room:
 Marked point:
 (2.950 m, 11.500 m, 5.800 m)



Scale 1 : 48

Grid: 128 x 128 Points

E_{av} [lx]
130

E_{min} [lx]
85

E_{max} [lx]
200

u_0
0.66

E_{min} / E_{max}
0.43

Ceiling / Value Chart (E)

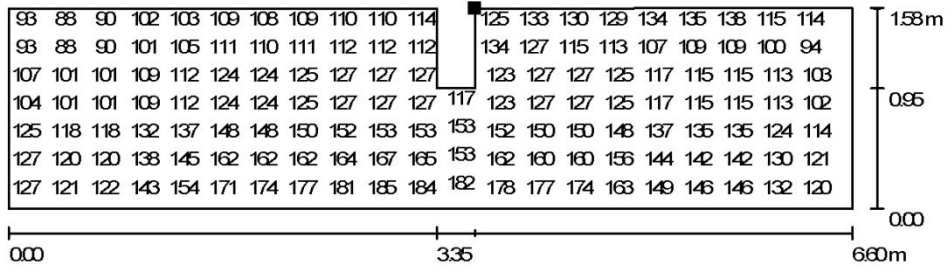

Values in Lux, Scale 1 : 48

Not all calculated values could be displayed.

Position of surface in room:
Marked point:
(2.950 m, 11.500 m, 5.800 m)



Grid: 128 x 128 Points

E_{av} [lx]
130

E_{min} [lx]
85

E_{max} [lx]
200

$u0$
0.66

E_{min} / E_{max}
0.43

Ceiling / Greyscale (E)

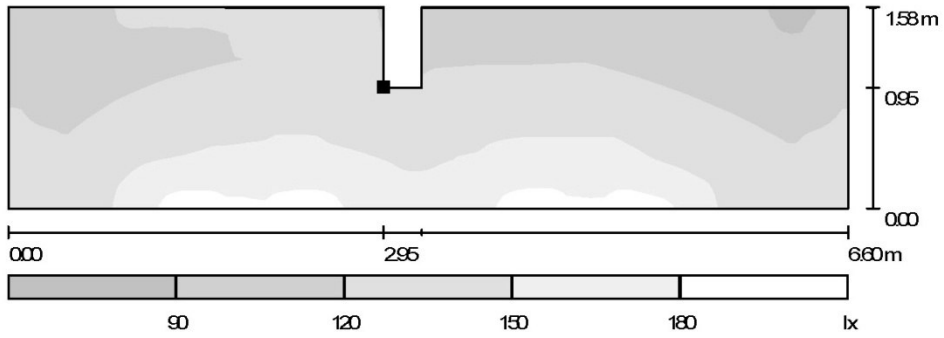

Scale 1 : 48

Position of surface in room:
Marked point:
(2.950 m, 0.600 m, 5.600 m)

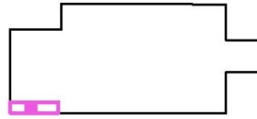

Grid: 128 x 128 Points

E_{av} [lx]
132

E_{min} [lx]
89

E_{max} [lx]
199

u_0
0.68

E_{min} / E_{max}
0.45

Ceiling / Value Chart (E)

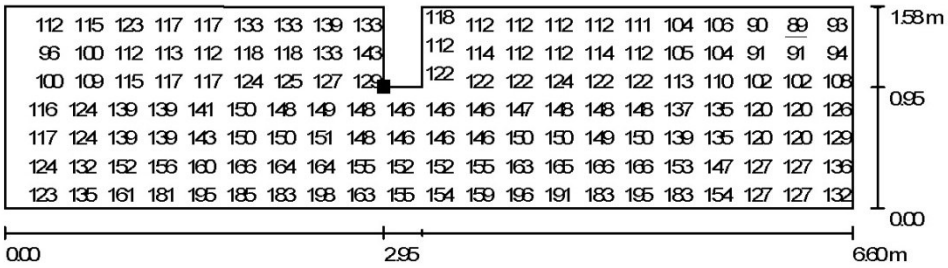

Not all calculated values could be displayed.

Values in Lux, Scale 1 : 48

Position of surface in room:
Marked point:
(2.950 m, 0.600 m, 5.600 m)



Grid: 128 x 128 Points

E_{av} [lx]	E_{min} [lx]	E_{max} [lx]	$u0$	E_{min} / E_{max}
132	89	199	0.68	0.45

Ceiling / Isolines (E)

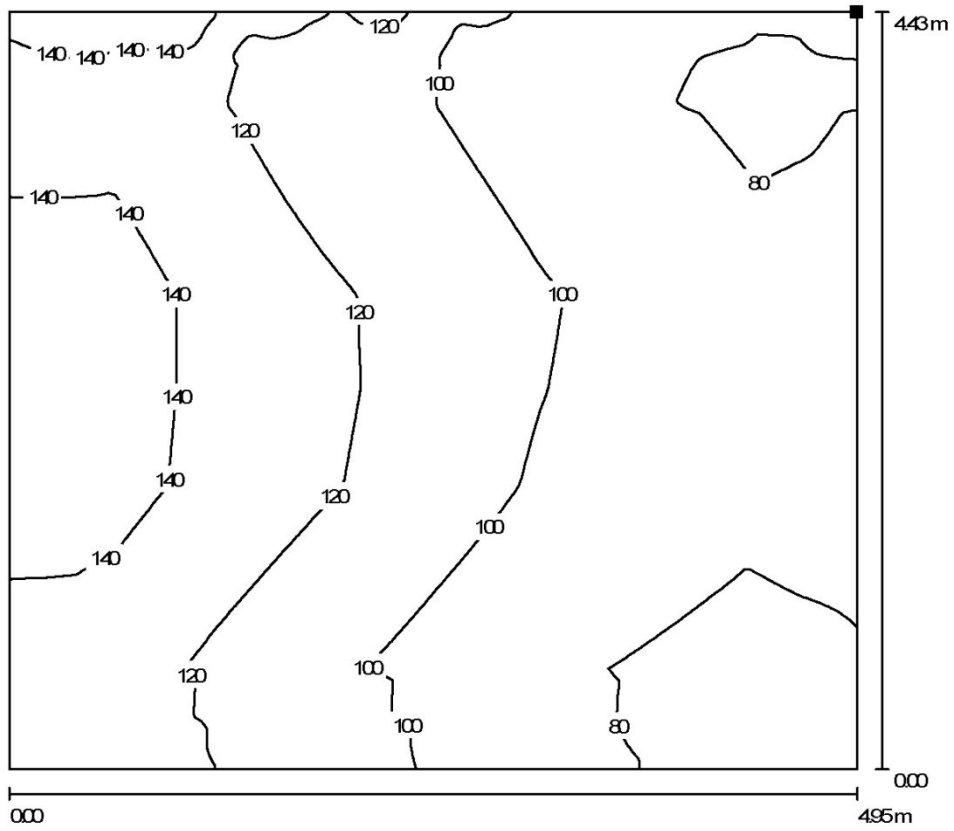

Values in Lux, Scale 1 : 36

Position of surface in room:
Marked point:
(34.400 m, 5.570 m, 5.800 m)

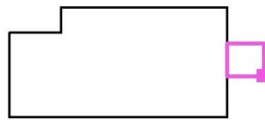

Grid: 128 x 128 Points

E_{av} [lx]	E_{min} [lx]	E_{max} [lx]	$u0$	E_{min} / E_{max}
107	70	155	0.66	0.45

Ceiling / Greyscale (E)

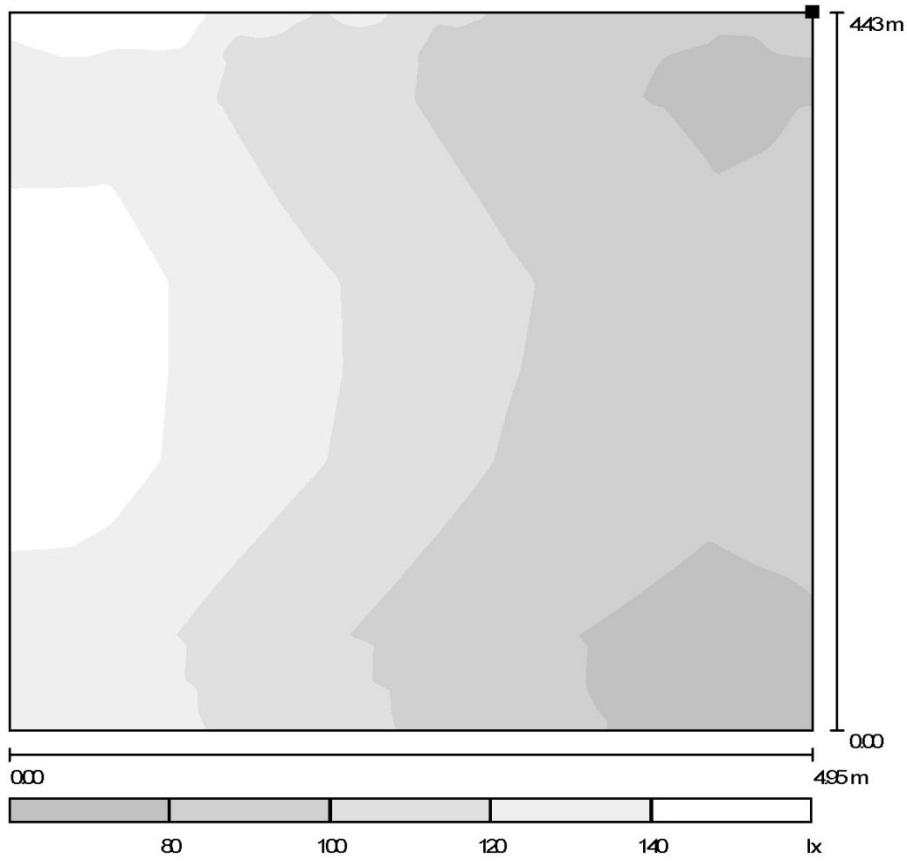

Position of surface in room:
 Marked point:
 (34.400 m, 5.570 m, 5.800 m)

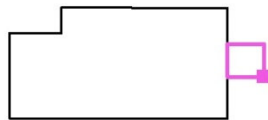

Scale 1 : 38

Grid: 128 x 128 Points

E_{av} [lx]	E_{min} [lx]	E_{max} [lx]	$u0$	E_{min} / E_{max}
107	70	155	0.66	0.45

Ceiling / Value Chart (E)

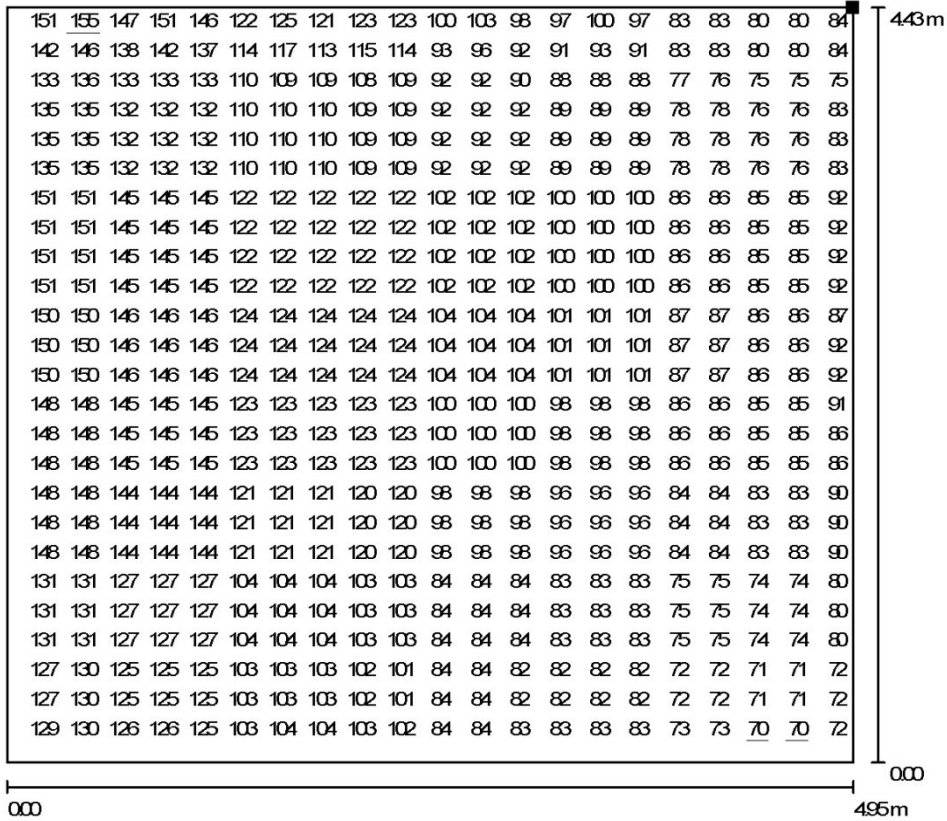

Values in Lux, Scale 1 : 36

Not all calculated values could be displayed.

Position of surface in room:
Marked point:
(34.400 m, 5.570 m, 5.800 m)

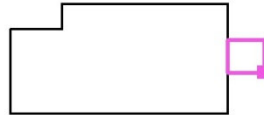

Grid: 128 x 128 Points

E_{av} [lx]	E_{min} [lx]	E_{max} [lx]	$u0$	E_{min} / E_{max}
107	70	155	0.66	0.45

Ceiling / Isolines (E)

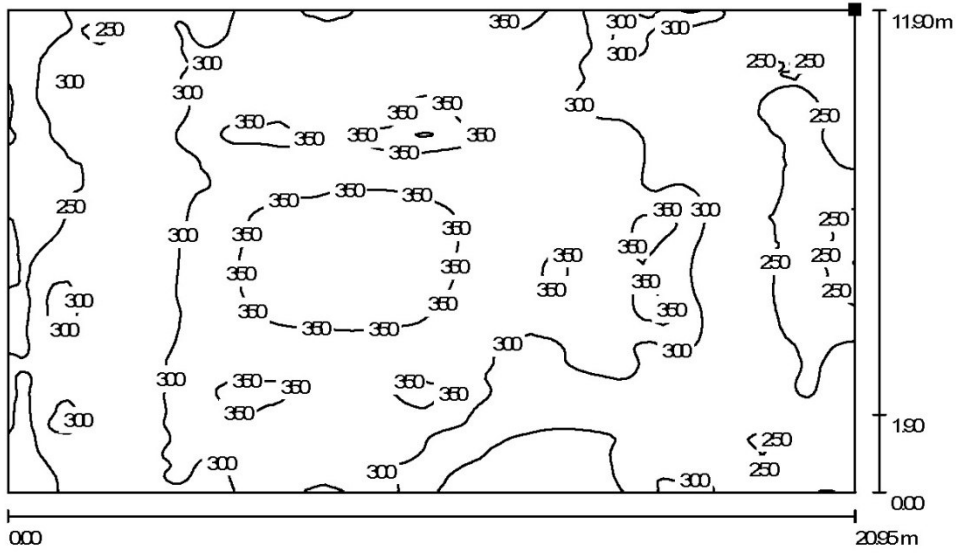

Values in Lux, Scale 1 : 150

Position of surface in room:
Marked point:
(27.950 m, 1.500 m, 5.300 m)



Grid: 128 x 128 Points

E_{av} [lx]
299

E_{min} [lx]
201

E_{max} [lx]
419

u_0
0.67

E_{min} / E_{max}
0.48

Ceiling / Greyscale (E)

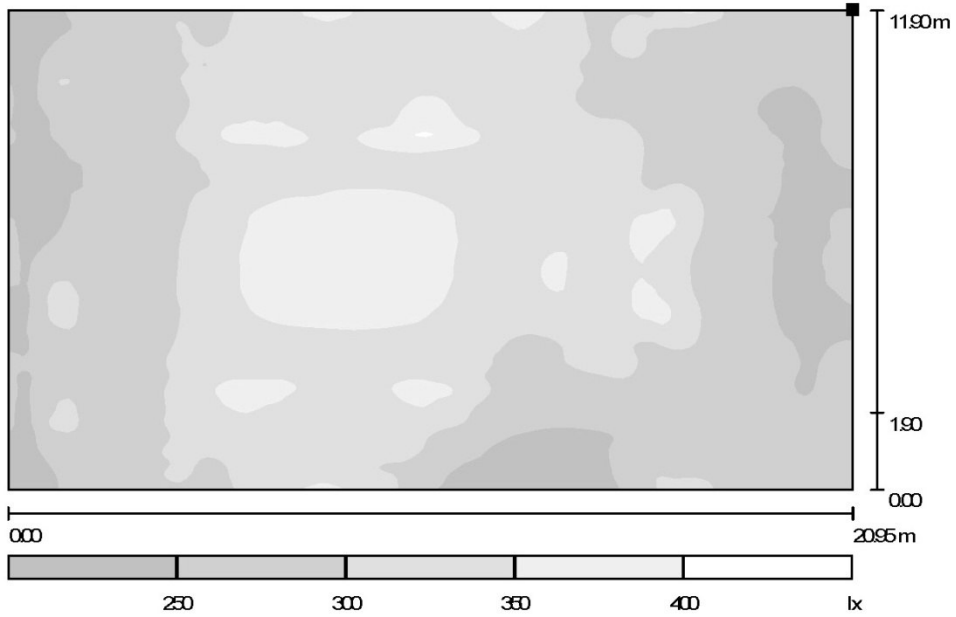

Scale 1 : 150

Position of surface in room:
Marked point:
(27.950 m, 1.500 m, 5.300 m)



Grid: 128 x 128 Points

E_{av} [lx]	E_{min} [lx]	E_{max} [lx]	u0	E_{min} / E_{max}
299	201	419	0.67	0.48

Ceiling / Value Chart (E)

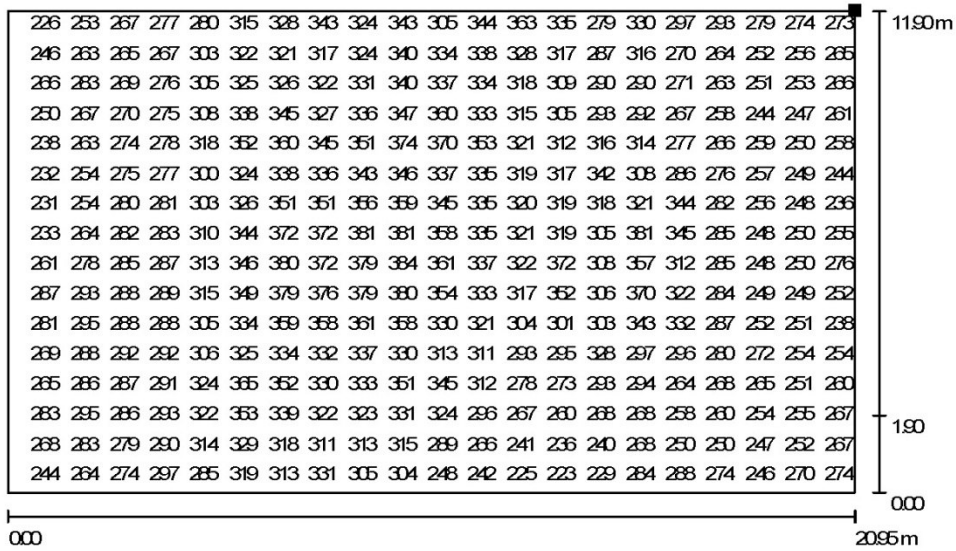

Values in Lux, Scale 1 : 150

Not all calculated values could be displayed.

Position of surface in room:
Marked point:
(27.950 m, 1.500 m, 5.300 m)

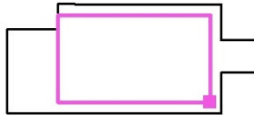

Grid: 128 x 128 Points

E_{av} [lx]
299

E_{min} [lx]
201

E_{max} [lx]
419

u_0
0.67

E_{min} / E_{max}
0.48

Wall / Greyscale (E)

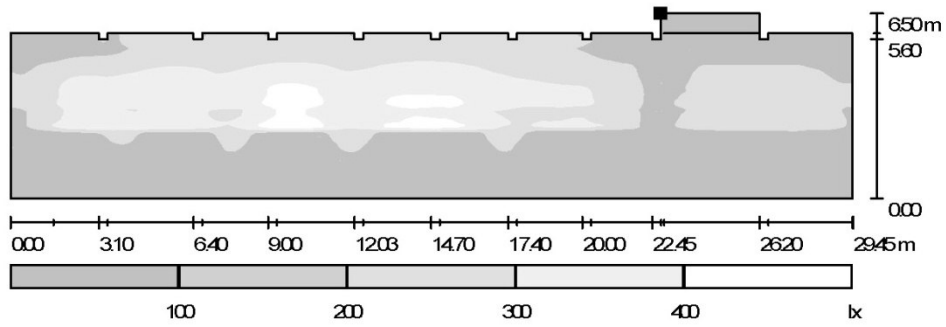

Scale 1 : 211

Position of surface in room:
Marked point:
(6.700 m, 0.000 m, 6.500 m)



Grid: 128 x 128 Points

E_{av} [lx]
175

E_{min} [lx]
3.39

E_{max} [lx]
481

$u0$
0.02

E_{min} / E_{max}
0.01

Wall / Value Chart (E)

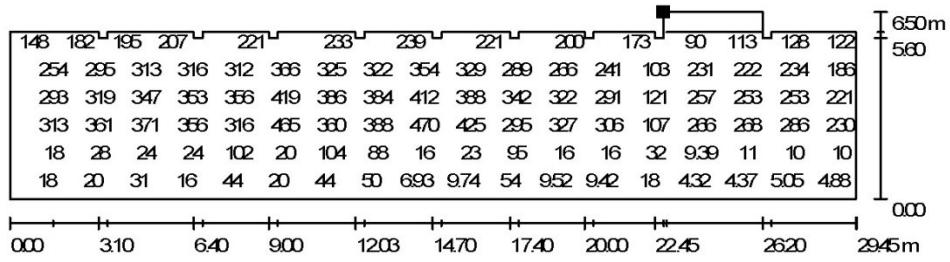

Values in Lux, Scale 1 : 211

Not all calculated values could be displayed.

Position of surface in room:
Marked point:
(6.700 m, 0.000 m, 6.500 m)

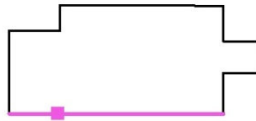

Grid: 128 x 128 Points

E_{av} [lx]	E_{min} [lx]	E_{max} [lx]	u0	E_{min} / E_{max}
175	3.39	481	0.02	0.01

Wall / Greyscale (E)

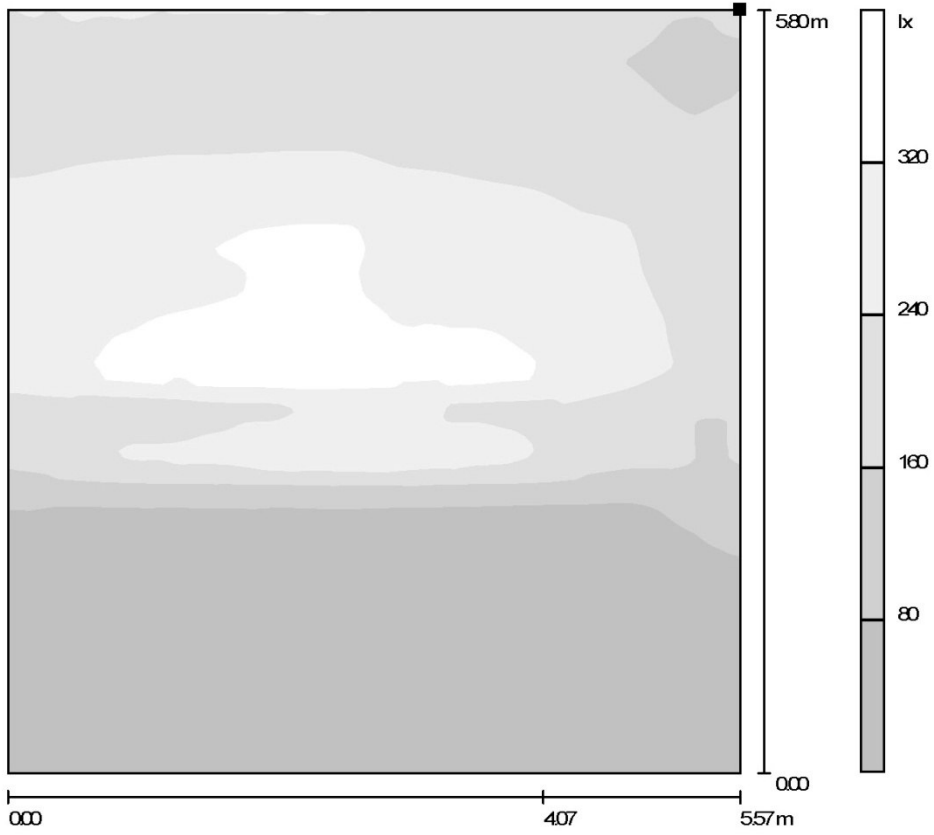

Position of surface in room:
Marked point:
(29.450 m, 0.000 m, 5.800 m)



Scale 1 : 46

Grid: 128 x 128 Points

E_{av} [lx]
168

E_{min} [lx]
17

E_{max} [lx]
371

u_0
0.10

E_{min} / E_{max}
0.05

Wall / Value Chart (E)

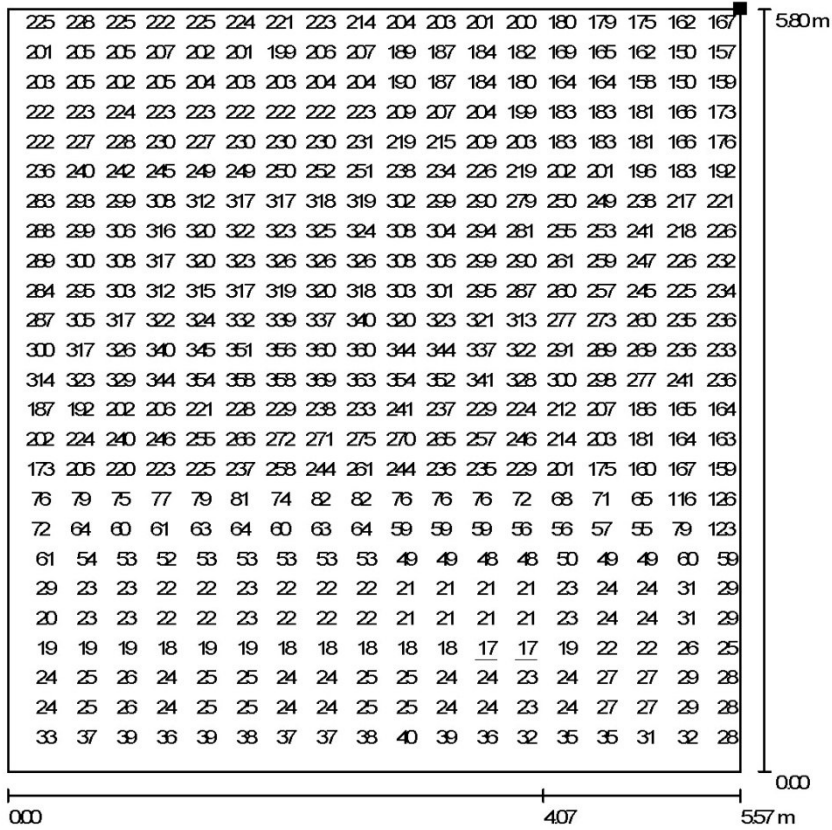

Values in Lux, Scale 1 : 46

Not all calculated values could be displayed.

Position of surface in room:
Marked point:
(29.450 m, 0.000 m, 5.800 m)

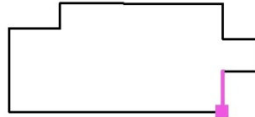

Grid: 128 x 128 Points

E_{av} [lx]
168

E_{min} [lx]
17

E_{max} [lx]
371

u0
0.10

E_{min} / E_{max}
0.05

Wall / Greyscale (E)

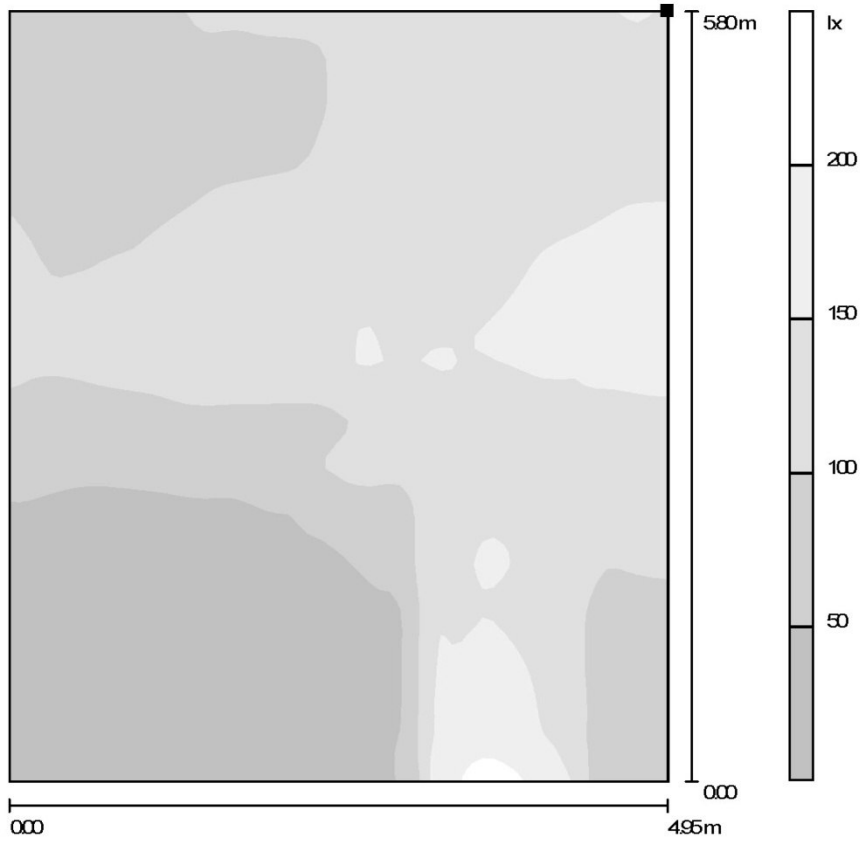

Position of surface in room:
Marked point:
(29.450 m, 5.570 m, 5.800 m)



Scale 1 : 46

Grid: 64 x 64 Points

E_{av} [lx]
98

E_{min} [lx]
12

E_{max} [lx]
221

u_0
0.12

E_{min} / E_{max}
0.05

Wall / Value Chart (E)

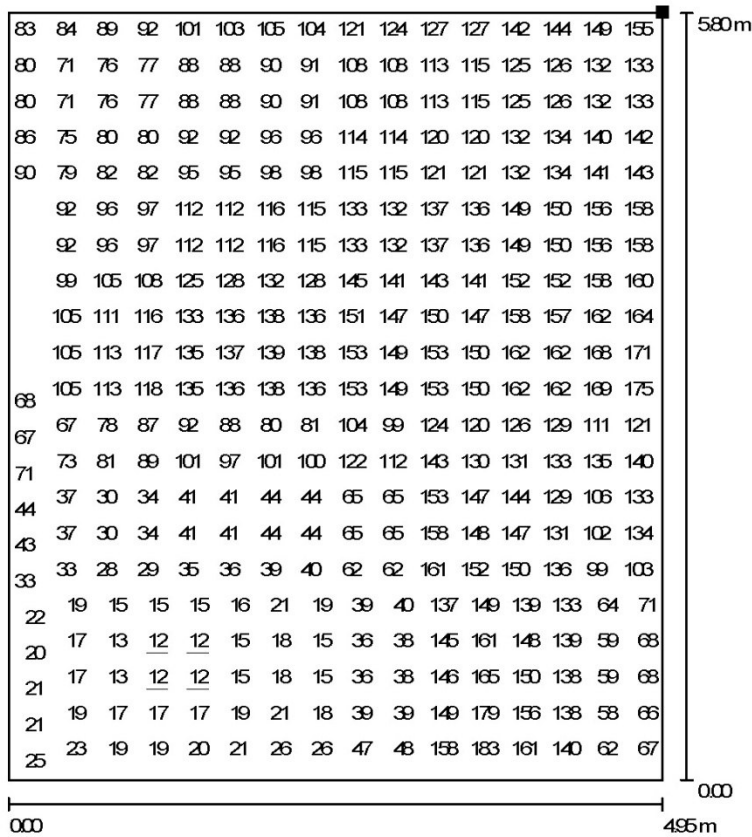

Not all calculated values could be displayed.

Values in Lux, Scale 1 : 46

Position of surface in room:
Marked point:
(29.450 m, 5.570 m, 5.800 m)

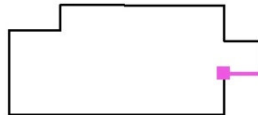

Grid: 64 x 64 Points

E_{av} [lx]
98

E_{min} [lx]
12

E_{max} [lx]
221

u_0
0.12

E_{min} / E_{max}
0.05

Wall / Greyscale (E)

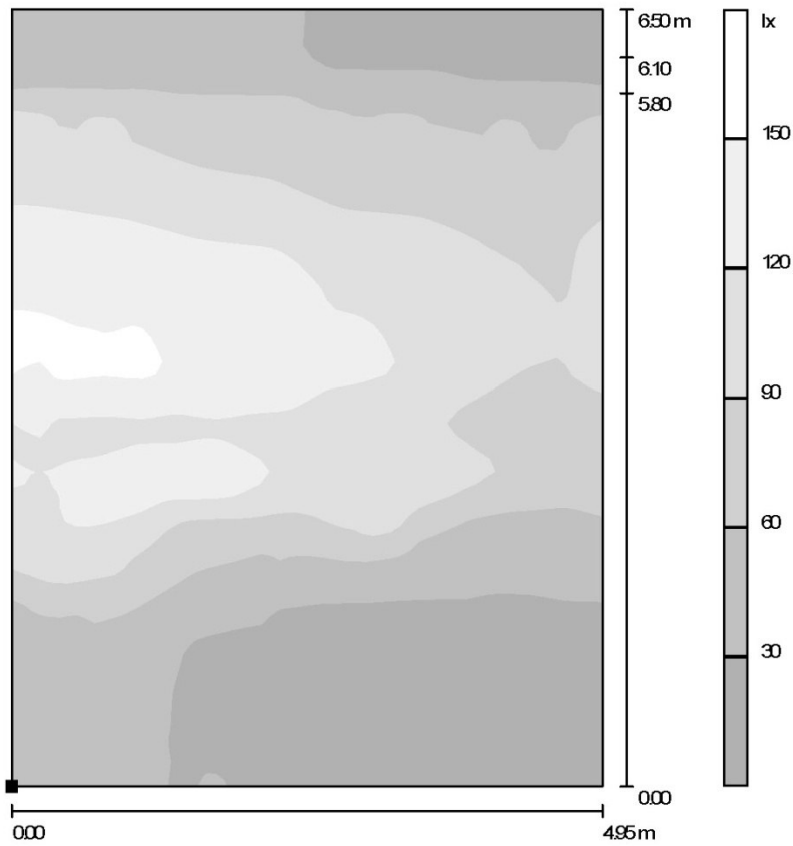

Position of surface in room:
Marked point:
(29.450 m, 10.000 m, 0.000 m)

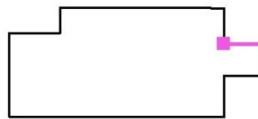

Scale 1 : 51

Grid: 64 x 64 Points

E_{av} [lx]
74

E_{min} [lx]
16

E_{max} [lx]
158

u_0
0.21

E_{min} / E_{max}
0.10

Wall / Value Chart (E)

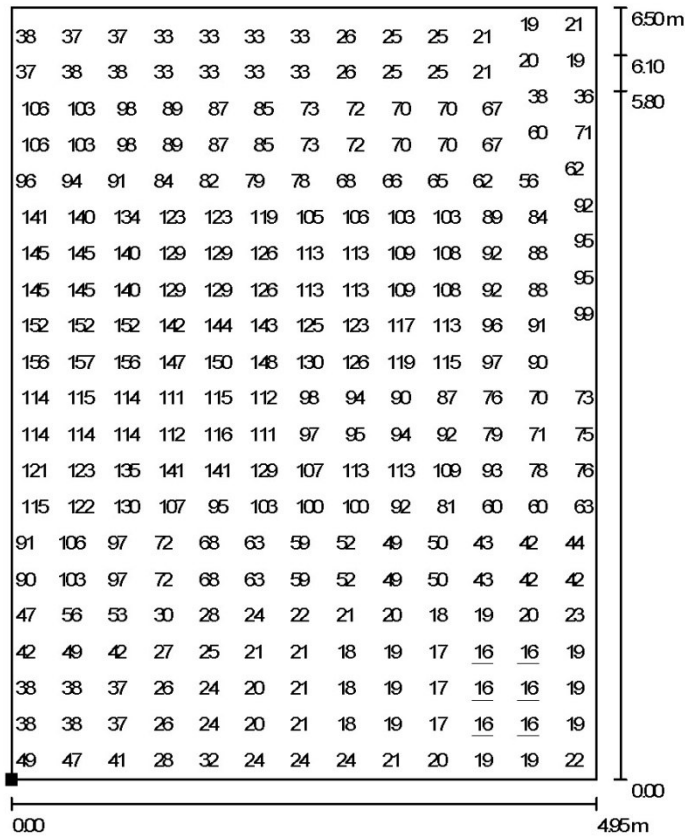

Values in Lux, Scale 1 : 51

Not all calculated values could be displayed.

Position of surface in room:
Marked point:
(29.450 m, 10.000 m, 0.000 m)

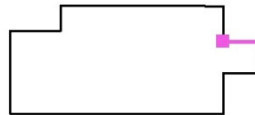

Grid: 64 x 64 Points

E_{av} [lx]
74

E_{min} [lx]
16

E_{max} [lx]
158

u_0
0.21

E_{min} / E_{max}
0.10

Wall / Greyscale (E)

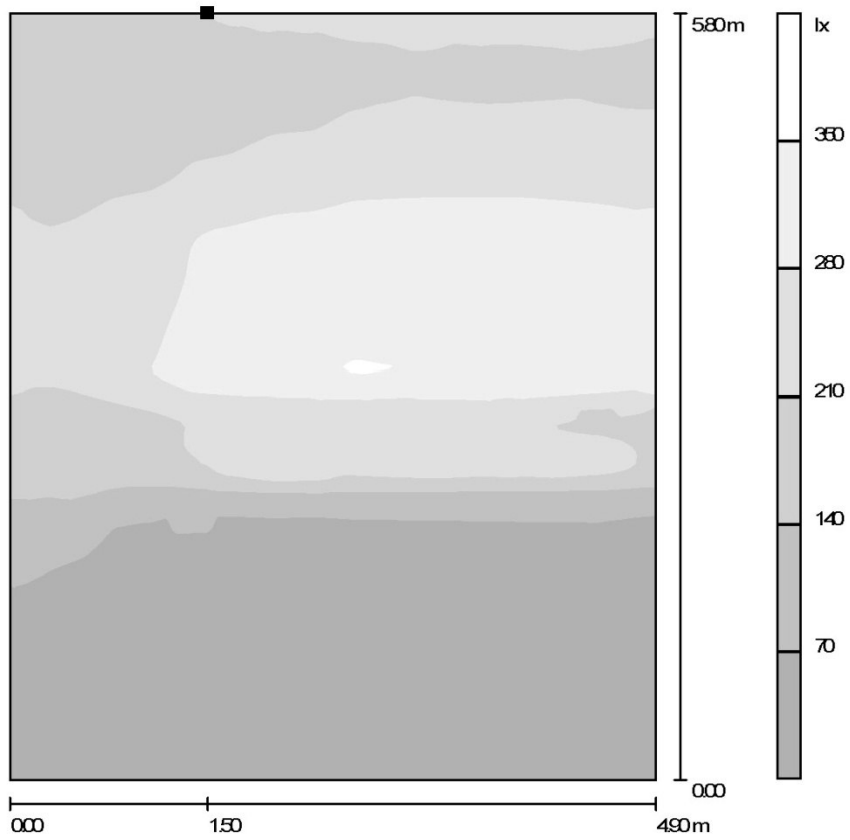

Position of surface in room:
 Marked point:
 (29.450 m, 13.400 m, 5.800 m)



Scale 1 : 46

Grid: 128 x 128 Points

E_{av} [lx]
167

E_{min} [lx]
18

E_{max} [lx]
360

$u0$
0.11

E_{min} / E_{max}
0.05

Wall / Value Chart (E)

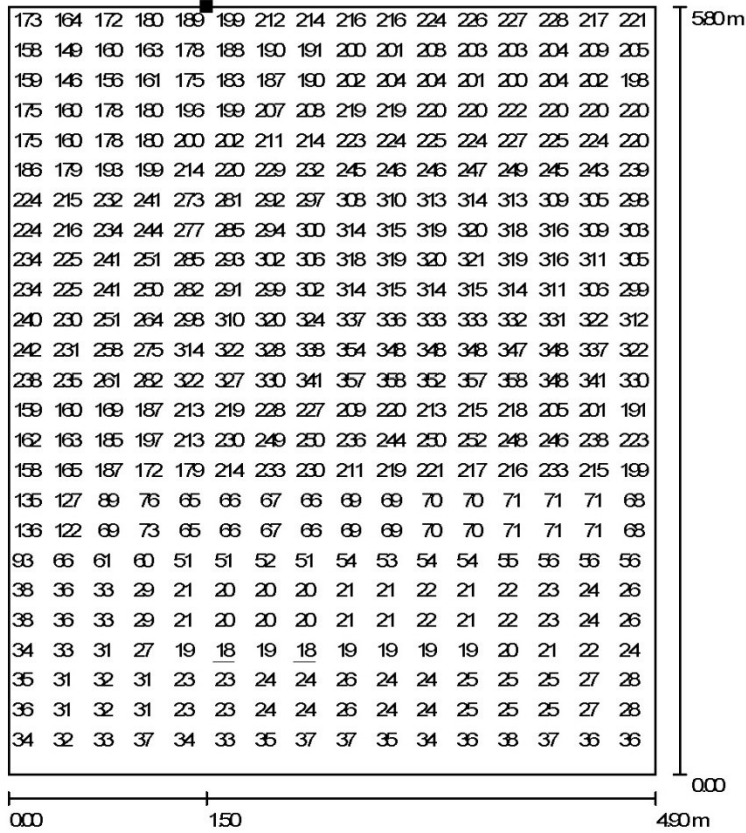

Values in Lux, Scale 1 : 46

Not all calculated values could be displayed.

Position of surface in room:
Marked point:
(29.450 m, 13.400 m, 5.800 m)

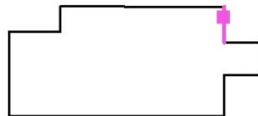

Grid: 128 x 128 Points

E_{av} [lx]
167

E_{min} [lx]
18

E_{max} [lx]
360

$u0$
0.11

E_{min} / E_{max}
0.05

Wall / Greyscale (E)

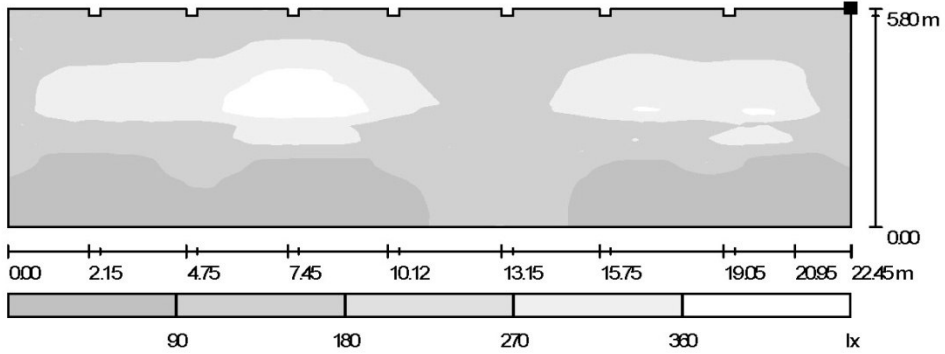

Scale 1 : 161

Position of surface in room:
Marked point:
(29.450 m, 14.900 m, 5.800 m)



Grid: 128 x 128 Points

E_{av} [lx]	E_{min} [lx]	E_{max} [lx]	u0	E_{min} / E_{max}
199	19	428	0.10	0.05

Wall / Value Chart (E)

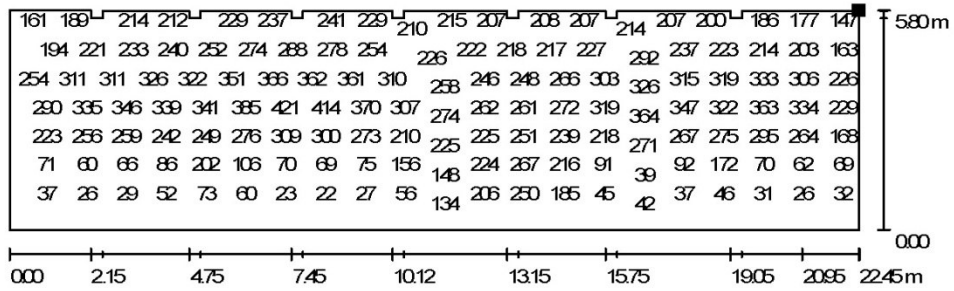

Values in Lux, Scale 1 : 161

Not all calculated values could be displayed.

Position of surface in room:
Marked point:
(29.450 m, 14.900 m, 5.800 m)



Grid: 128 x 128 Points

E_{av} [lx]	E_{min} [lx]	E_{max} [lx]	u0	E_{min} / E_{max}
199	19	428	0.10	0.05

Wall / Greyscale (E)

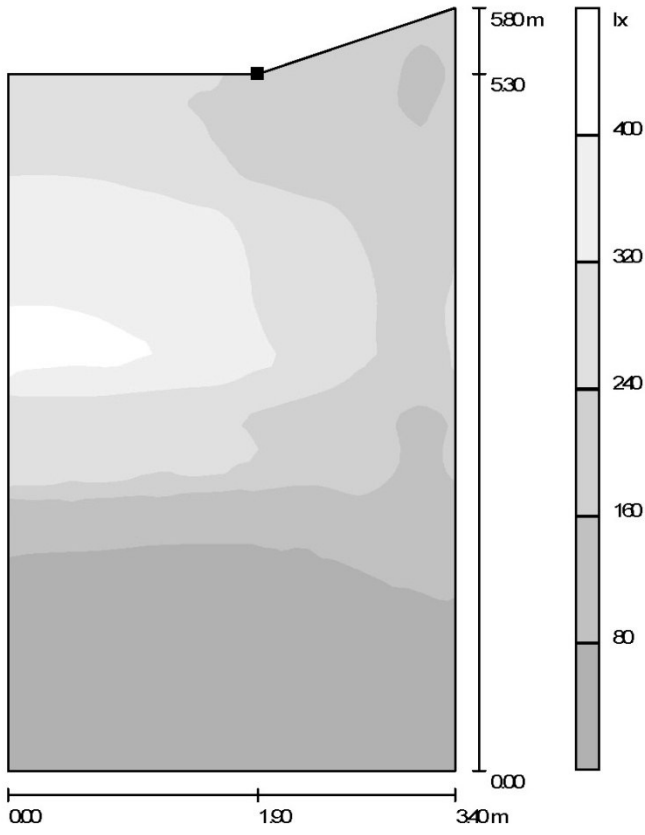

Position of surface in room:
Marked point:
(7.000 m, 13.400 m, 5.300 m)



Scale 1 : 46

Grid: 64 x 64 Points

E_{av} [lx]
187

E_{min} [lx]
31

E_{max} [lx]
421

$u0$
0.17

E_{min} / E_{max}
0.07

Wall / Value Chart (E)

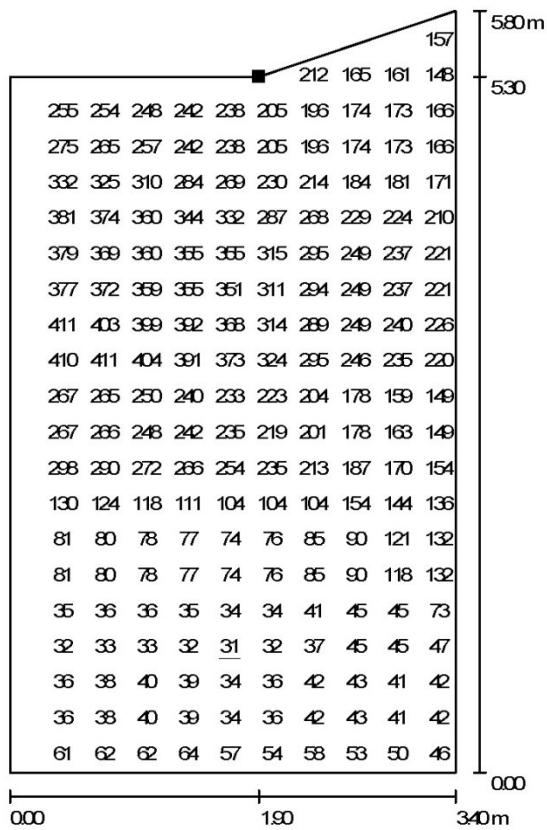

Values in Lux, Scale 1 : 46

Not all calculated values could be displayed.

Position of surface in room:
Marked point:
(7.000 m, 13.400 m, 5.300 m)

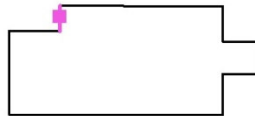

Grid: 64 x 64 Points

E_{av} [lx]
187

E_{min} [lx]
31

E_{max} [lx]
421

u0
0.17

E_{min} / E_{max}
0.07

Wall / Greyscale (E)

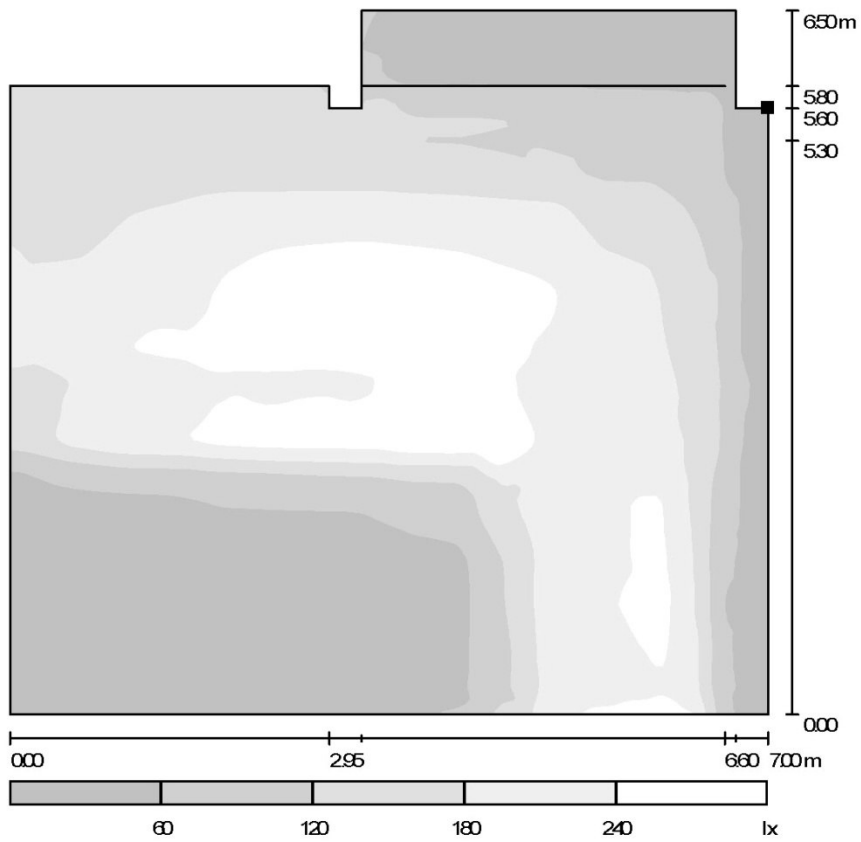

Position of surface in room:
 Marked point:
 (7.000 m, 11.500 m, 5.600 m)

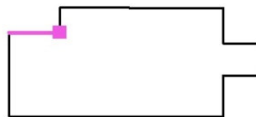

Scale 1 : 56

Grid: 128 x 128 Points

E_{av} [lx]	E_{min} [lx]	E_{max} [lx]	u0	E_{min} / E_{max}
138	7.86	291	0.06	0.03

Wall / Value Chart (E)

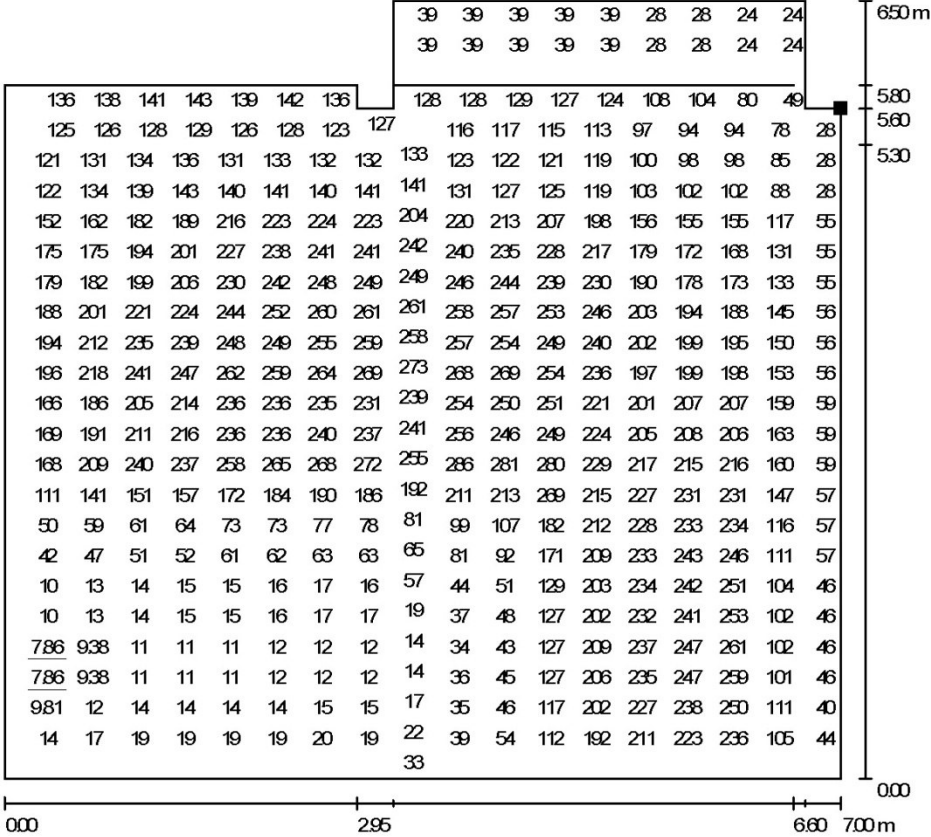

Values in Lux, Scale 1 : 51

Not all calculated values could be displayed.

Position of surface in room:
Marked point:
(7.000 m, 11.500 m, 5.600 m)



Grid: 128 x 128 Points

E_{av} [lx]	E_{min} [lx]	E_{max} [lx]	u_0	E_{min} / E_{max}
138	7.86	291	0.06	0.03

Wall / Greyscale (E)

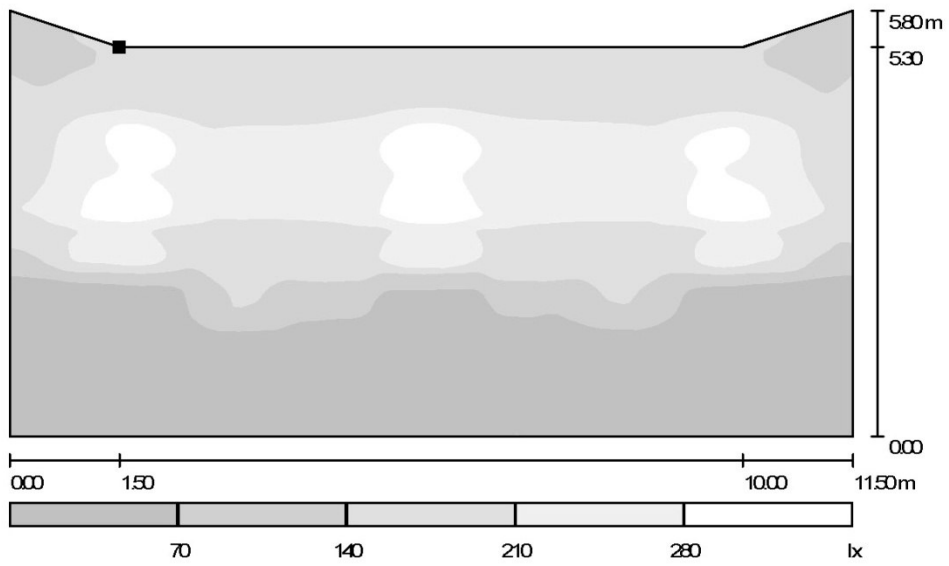

Position of surface in room:
Marked point:
(0.000 m, 1.500 m, 5.300 m)

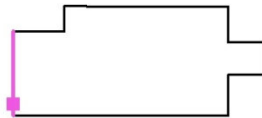

Scale 1 : 83

Grid: 128 x 128 Points

E_{av} [lx]
141

E_{min} [lx]
5.71

E_{max} [lx]
343

u_0
0.04

E_{min} / E_{max}
0.02

Wall / Value Chart (E)

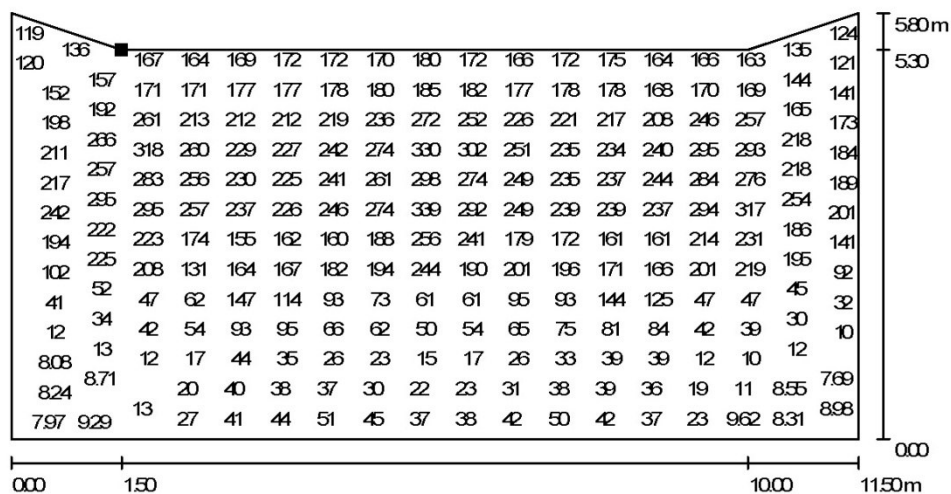

Values in Lux, Scale 1 : 83

Not all calculated values could be displayed.

Position of surface in room:
Marked point:
(0.000 m, 1.500 m, 5.300 m)



Grid: 128 x 128 Points

E_{av} [lx]
141

E_{min} [lx]
5.71

E_{max} [lx]
343

u_0
0.04

E_{min} / E_{max}
0.02

APPENDIX C

SURVEY

1. Personal Information:

1.1. Sex: female
male

1.2. Age years old

1.3. Job

1.4. Do you wear glasses or lenses yes
no

if yes: longsighted
shortsighted
astigmatic

Please do not fill below this line

1.6. The temperature in space :C

1.7. The temperature outside :C

1.8. Time :

2. Lighting and Task:

Please answer the questions below, only after you have visited all parts of the gallery.

For the questions with a scale, make a circle in the appropriate row on your answer sheet with a number close to your opinion.

extremely	slightly	neutral	slightly	extremely
1	2	3	4	5

2.1. Perception of the images in the print-outs under this lighting arrangement is

strong 1 2 3 4 5 weak

2.2. The ability to concentrate and interact with the exhibition under this lighting arrangement is

strong 1 2 3 4 5 weak

2.3. The informative texts are readable under this lighting arrangement

yes no

2.4. Have you seen any reflected images on the vertical planes of exhibition? If yes, please specify the exact location on the map.

yes no

3. Aesthetic and Environmental Judgments:

Please make a circle in the appropriate row with a number close to your opinion.

extremely	slightly	neutral	slightly	extremely
1	2	3	4	5

3.1. Perception of the form of the gallery under this lighting arrangement is

strong 1 2 3 4 5 weak

3.2. Perception of the structural elements under this lighting arrangement is

strong 1 2 3 4 5 weak

3.3. Perception of details [materials of architectural components and furnishing and their characteristics such as texture and color] of the gallery under this lighting arrangement is

strong 1 2 3 4 5 weak

3.4. The general illumination in the gallery is

too dark 1 2 3 4 5 too bright

3.5. The illumination on the ceiling is

too dark 1 2 3 4 5 too bright

3.6. The illumination on the walls are

too dark 1 2 3 4 5 too bright

3.7. The general illumination in the gallery is

uniform 1 2 3 4 5 not uniform

3.8. The gallery under this lighting arrangement appears as

inviting 1 2 3 4 5 repulsive

3.9. The gallery under this lighting arrangement appears as

cozy 1 2 3 4 5 cold

3.10. The gallery under this lighting arrangement appears as

interesting 1 2 3 4 5 dull

3.11. I like the gallery under this lighting arrangement

yes 1 2 3 4 5 no

4. Feelings:

Take about two minutes to really get into the mood of the situation created by the interior lighting; then rate your feelings in the situation with the adjective pairs below. Some of the pairs might seem unusual, but you'll probably feel more one way than the other. So, for each pair, make a circle in the appropriate row with a number close to the adjective which you believe to describe your feelings better. The more appropriate that adjective seems, the more closer the circle you fill in.

extremely	slightly	neutral	slightly	extremely
1	2	3	4	5

I feel under this lighting arrangement

Happy	1 2 3 4 5	Unhappy
Annoyed	1 2 3 4 5	Pleased
Relaxed	1 2 3 4 5	Tense
Autonomous	1 2 3 4 5	Guided
Hopeful	1 2 3 4 5	Despairing
Aroused	1 2 3 4 5	Unaroused
Dominant	1 2 3 4 5	Submissive
Sleepy	1 2 3 4 5	Wide-awake
Talkative	1 2 3 4 5	Shy
Excited	1 2 3 4 5	Calm
Controlling	1 2 3 4 5	Controlled
Satisfied	1 2 3 4 5	Unsatisfied
Stable	1 2 3 4 5	Depressed
Important	1 2 3 4 5	Unimportant

5. Perceptual Preferences:

5.1. Do you think this lighting arrangement creates any hierarchical order (lit, semi-lit, and dark) in the gallery? Do you think that there is variance in the degree that a part of the space (structural elements, ceiling, walls, etc.) or part of the exhibition is perceived better than another? Please specify.

Lit :

Semi-lit :

Dark :

5.3. Please stand on the points displayed with SP on the map and decide which direction to take without concerning the exhibit just the lighting itself. Which direction is it?

For SP1:

d1 d2 does not matter

For SP2

d1 d2 d3 does not matter

VITA

Hilmi Gökhan Kutlu, son of Münevver and Orhan, little brother of Okan, was born on 30th April 1973 in İstanbul. He attended Özel Türk High School in İzmir, and was graduated in 1991. He was admitted to Dokuz Eylül University in September 1991 and received his bachelor degree in 1996. He was accepted to the Master of Science Program in Architecture in September 1996 and received his M.Sc. Degree in June 2000.

He is currently holding a research/teaching assistant position at İzmir Institute of Technology since October 1997. He has assisted basic design studio and building technology and science courses.

His research interests are architectural lighting, basic design, and modern architecture. He is a member of Chamber of Architects since July 1996, and Docomomo-tr National Committee since November 2005.

His current e-mail address is hgokhankutlu@gmail.com.