

**ARCHITECTURAL CHARACTERISTICS  
AND CONSTRUCTION TECHNIQUES OF  
DOMES IN A GROUP OF OTTOMAN BATHS**

**A Thesis Submitted to  
the Graduate School of Engineering and Sciences of  
İzmir Institute of Technology  
in Partial Fulfillment of the Requirements for the Degree of  
DOCTOR OF PHILOSOPHY**

**in Architecture**

**by  
Kader REYHAN**

**June 2011  
İZMİR**

We approve the thesis of **Kader REYHAN**

---

**Prof. Dr. Bařak İPEKOĐLU**  
Supervisor

---

**Prof. Dr. Hasan BÖKE**  
Committee Member

---

**Assist. Prof. Dr. M. Emre ERĐÜL**  
Committee Member

---

**Assist. Prof. Dr. Fehmi DOĐAN**  
Committee Member

---

**Prof. Dr. Zeynep MERCANGÖZ**  
Committee Member

**21 June 2011**

---

**Assoc. Prof. Dr. Serdar KALE**  
Head of the Department of Architecture

---

**Prof. Dr. Durmuř Ali DEMİR**  
Dean of the Graduate School of  
Engineering and Sciences

## ACKNOWLEDGEMENTS

First, I would like to thank and to depict deeply gratitude to my supervisor, Prof. Dr. Başak İPEKOĞLU, for her support during my study with her comments, encouragement, incredible patience and understanding. This thesis could not be completed without her valuable support.

I would like to depict gratitude to the committee members; Prof. Dr. Hasan Böke, Assist. Prof. Dr. M. Emre Ergül, Assist. Prof. Dr. Fehmi Doğan, Prof. Dr. Zeynep Mercangöz, and Assoc. Prof. Dr. S. Sarp Tunçoku for their valuable comments and recommendations.

I thank Doğay Korkmaz and Gökhan Hüseyin Erkan for their support during field surveys and the Department of Architectural Restoration for supporting my study with archive documents, special thanks to Kerem Şerifaki, Elif Uğurlu Sağın, Çağlayan Deniz Kaplan, Fulya Murtezaoğlu, and of course Çiçek Aktuna.

Special thanks to my friends for their supports, Uğur Yankaya, Başak Gücyeter, Evrim Güçer, Funda Yaka Çetin, Ülkü İnceköse, Fatma İpek Ek, Feray Maden, Naki Alkaya, Yelda Mert, Nida Kamil Özbolat, Eda Uçak, Hayriye Oya Saf, Eylül Polat and Ayşe Nur Şenel. Besides, I would like to thank my brothers, Erkan Reyhan, Ender Reyhan, Enver Reyhan and my sister Nuray Reyhan Tümer for their incredible support and patience during the completion of this thesis.

Finally, my deep graditute and appreciation to my family for their help and supports during preparing this thesis and all my life. This thesis would never have been completed without their patience and support.

# ABSTRACT

## ARCHITECTURAL CHARACTERISTICS AND CONSTRUCTION TECHNIQUES OF DOMES IN A GROUP OF OTTOMAN BATHS

In Ottoman bath architecture, domes adjoined in varied numbers and sizes are structural element ensuring dynamic superstructure adjustment exterior and fascinating spatial features involving the interior lighting elements. The examination of cause-effect relationship in the original architectural and constructional characteristics of domes, the main elements of dynamic superstructure adjustment, is significant in terms of pointing out the retention features of construction details. In addition, informed knowledge for the purpose of contributing to conservation works of the baths is necessary to focus on in this dissertation.

The aim of the dissertation is to identify the original morphological characteristics, construction techniques and use of materials and to investigate the relationship between architectural and constructional characteristics that involve span, height, thickness, bond types, the number and rows of oculi, the type of transition elements and the height of transition element and the exterior supporting elements of the dome. In this context, the domes of the studied baths were examined in term of construction techniques in superstructure integrality with their supporting elements.

In this content; the original morphological characteristics, construction techniques and the use of materials on the Ottoman domes with their supporting elements, transition elements and frame of the domes from outside were examined by the use of conventional method through field survey and were studied in the framework of cause-effect relationships. In addition, statistical analysis methods were used and evaluated in order to examine the relationships between architectural and constructional characteristics of domes.

This dissertation is significant in terms of contributing to cover a lack of knowledge in construction systems of domes and transition elements of the public baths for the purpose of constitution of systematic knowledge in leading protection and conservation decisions.

# ÖZET

## OSMANLI DÖNEMİ BİR GRUP HAMAM KUBBESİNİN MİMARİ ÖZELLİKLERİ VE YAPIM TEKNİKLERİ

Osmanlı hamam mimarisinde kubbe, farklı boyut ve sayıda birbirine eklenerek dışta kitleye hareket kazandıran içte ise üzerlerinde düzenlenmiş ışık gözleriyle zengin mekân özellikleri oluşturan strüktürel bir yapı elemanıdır. Üst örtünün dinamik etkisini veren kubbelerin özgün mimari ve yapısal özelliklerinin tespit edilmesi ve bunlar üzerinde neden-sonuç ilişkisinin irdelenmesi, kubbelerin onarımları sırasında yapı detaylarının kaybedilmemesi gereken özelliklerine dikkat çekmesi açısından önemlidir. Bunun yanı sıra, kubbelerin yapım tekniği konusundaki araştırmaların yetersiz olması, yapıların onarılması ve korunması için bilgi üreten çalışmaların yapılmasını gerekli kılmaktadır.

Bu çalışmanın amacı, Osmanlı dönemi hamam kubbelerinin özgün biçimsel ve yapısal özelliklerinin tanımlanması ve bu özelliklerin kubbe bütünlüğü içerisinde ilişki ağının araştırılmasıdır. Bu temel doğrultuda çalışma konusu olarak seçilen hamamların kubbeleri, kubbeye geçiş öğeleri ve kubbe dış destek elemanları ile birlikte ele alınarak biçim-strüktür açısından incelenmiş ve bütünsellik içerisindeki ilişkiler üzerinde durulmuştur. Bu çerçevede, incelenen kubbelerde kubbe açıklığı, kubbe yüksekliği, kubbe kalınlığı, örgü türleri, kubbe üzerinde bulunan ışık gözü sırası ve sayısı, kubbeye geçiş elemanı türü ve yüksekliği ve kubbe dış destek elemanı arasındaki ilişkiler incelenmiştir. Açıklık, yükseklik, kalınlık, örgü türü ve ışık gözü sayısı ve sırası, kubbeye geçiş elemanı arasındaki ilişkiler için istatistiksel analizler yapılmış ve değerlendirilmiştir.

Çalışma kapsamında; yapılardaki kubbe, kubbeye geçiş ve kubbe dış destek elemanlarının özgün biçimsel özellikleri, yapım tekniği ve malzeme kullanımı ile ilgili bilgiler, arazide yapılar üzerinde incelemeler yapılarak tespit edilmiş, çizim ve yazılı anlatımı bir arada içeren tablolar ve grafikler hazırlanarak toplanan bilgilerin karşılaştırmalı değerlendirmesi yapılmıştır.

Bu çalışma, üst örtünün yapım tekniği ile ilgili araştırmalardaki bilgi azlığını gidermede, yapıların onarılması ve korunması için gerekli detaylı bilginin oluşturulmasında önemli bir katkısı olacaktır.

*to my beloved mother Zehra REYHAN and  
beloved father Vahit REYHAN, whose presence is given the best  
gift to me in my all life*

*and also to my beloved late brother Erdal  
REYHAN, who and especially whose smile have been living in  
my heart and in my memories forever*

*varlıkları yaşamım boyunca bana verilmiş  
en büyük hediye olan sevgili annem Zehra REYHAN ve sevgili  
babam Vahit REYHAN'a*

*ayrıca varlığı ve özellikle gülümsemesi  
kalbimde ve anılarımda daim olan sevgili kardeşim Erdal  
REYHAN'a*

# TABLE OF CONTENTS

LIST OF FIGURES.....	xi
LIST OF TABLES .....	xviii
CHAPTER 1. INTRODUCTION .....	1
1.1. Aim and Content of the Study.....	1
1.2. Methodology .....	6
1.2.1. Sources .....	8
1.2.1.1. Studies on Domes in General.....	9
1.2.1.2. Studies on Domes of the Baths that are Subject of the Thesis.....	16
1.2.1.3. Measured Surveys and Photographs .....	18
1.2.2. Terminology .....	18
CHAPTER 2. DEFINITIONS .....	20
2.1. Dome .....	20
2.1.1. Historical Background of Domes .....	20
2.1.1.1. Domes in the Roman and Byzantine Architecture.....	21
2.1.1.2. Domes in the Anatolian Seljuks and Principalities Architecture .....	22
2.1.1.3. Domes in the Ottoman Architecture.....	24
2.2. Profiles.....	24
2.2.1. Semi-circular Profiles in the Examined Domes .....	30
2.2.2. Depressed Profiles: One-centered and Two-centered.....	34
2.2.3. Two-centered Pointed Profiles in the Examined Domes .....	37
2.2.4. Segmented Profiles in the Examined Domes .....	39
2.2.4.1. Segmented Profiles in the Horizontal Direction .....	39
2.2.4.2. Segmented Profiles in the Vertical Direction .....	40
2.2.5. Segmented Semi-circular Profiles .....	41
2.2.6. Truncated-octogonal Pyramidal, on the Top Circular Depressed Profiles.....	42

2.2.7. Pyramidal Profiles.....	43
2.2.7.1. Square-pyramidal Profiles .....	43
2.2.7.2. Octagonal-pyramidal Profiles .....	44

CHAPTER 3. EXAMINATION AND EVALUATION OF ARCHITECTURAL CHARACTERISTICS AND CONSTRUCTION TECHNIQUES IN THE DOMES.....

3.1. Examination of the Dome Spans.....	49
3.1.1. Range of Domes in Spaces in accordance with Spans.....	50
3.1.2. Evaluation of the Domes according to Their Spans.....	55
3.2. Examination of Dome Heights.....	61
3.2.1. Examination of the Relationship between Dome Spans and Dome Height in Domes .....	62
3.2.2. Evaluation of the Relationship between Dome Spans and Dome Height in Domes .....	67
3.3. Examination of the Dome Thicknesses .....	71
3.3.1. Examination of the Relationship between Span and Thickness in Domes .....	72
3.3.2. Evaluation of the Relationship between Span and Thickness in Domes.....	76
3.4. Examination of the Bond Type in Domes .....	82
3.4.1. Examination of the Brick Bond Types.....	83
3.4.1.1. Horizontal Stacking of the Short Side Faces in Places Non-Parallel Rows .....	84
3.4.1.2. Horizontal and Adjacent Stacking of the Short Side Faces in Parallel Rows .....	86
3.4.1.3. Horizontal Stacking of Long Faces on the Bottom for a few Rows and Short Faces on Top in Parallel Rows .....	88
3.4.1.4. Random Horizontal Stacking of Long and Short Faces .....	90
3.4.1.5. In Vertical Sequential Stacking of Long/Short Faces on Interior, Horizontal Stacking of the Long Faces on Exterior Surface .....	92
3.4.2. Examination of the Brick / Stone and Stone Bond Types.....	94



3.4.2.1. Irregular Brick/Stone Bond Formed by Stacking of Brick and Cut Stone in Random Rows.....	94
3.4.2.2. Irregular Stone Bond Formed by Random and Irregular Stacking of Rubble and Cut Stone .....	96
3.4.3. Distribution of Bond Types in Domes .....	98
3.4.4. Examination of the Span to Height Relation in the Domes with Common Bond Type.....	102
3.4.4.1. Span to Height Relation in Horizontal Stacking of the Short Side Faces in Places Non-Parallel Rows Bond Type .....	102
3.4.4.2. Span to Height Relation in Horizontal and Adjacent Stacking of the Short Side Faces in Parallel Rows Bond Type .....	104
3.5. Examination of the Lighting Elements Arranged in Domes.....	106
3.5.1. Examination of Oculi in Domes .....	107
3.5.1.1. Oculi on Dome Surfaces.....	107
3.5.1.2. Oculi in Dome - Light Cupola or Top Skylight in the Center.....	109
3.5.1.2.1. Examination of the Light Cupolas in Domes.....	109
3.5.1.2.2. Examination of the Top Skylights in Domes.....	112
3.5.1.2.3. Examination of the Oculi in Domes with Light Cupola .....	113
3.5.2. Examination of the Lighting Lantern in Domes .....	119
3.5.2.1. Lighting Lantern in Domes.....	119
3.5.2.2. Lighting Lantern in Dome – Windows at the Springing Level.....	120
3.5.3. Examination of the Oculi according to the Dome Spans .....	120
3.5.4. Evaluation of the Dome Span and Number of Oculi Relation in Domes .....	122
3.6. Transition Elements to Examined Domes .....	125
3.6.1. The Types of the Transition Elements to the Dome .....	126
3.6.1.1. Pendentives .....	127
3.6.1.2. Squinches.....	127
3.6.1.3. Turkish Triangles .....	127

3.6.2. Examination of Transition Elements to Domes.....	128
3.6.3. Evaluation of the Relationship between Span and Height of Transition Elements.....	130
3.7. Examination of the Relationship between Span and Height of Exterior Supporting Elements in Domes.....	133
3.7.1. Evaluation of the Relationship between Span and Height of Exterior Supporting Elements in Domes.....	136
3.8. General Evaluation.....	142
CHAPTER 4. CONCLUSION.....	149
REFERENCES.....	154
APPENDIX A. CATALOGUES.....	162

## LIST OF FIGURES

<u>Figure</u>	<u>Page</u>
Figure 2.1. Different types of domes, developing forms of the domes from ancient time to the present.....	22
Figure 2.2. The Byzantine dome with a high cylindrical shell in an octagon shape.....	22
Figure 2.3. The elements forming the dome.....	25
Figure 2.4. The distribution of baths according to the profiles.....	26
Figure 2.5. The dome oblateness.....	29
Figure 2.6. The ratio of compression and tension parts of the dome to dome span.....	30
Figure 2.7. Semi-circular profiles.....	31
Figure 2.8. Tire Tahtakale Hamamı men’s section <i>sıcaklık</i> main space dome in semi-circular profile.....	31
Figure 2.9. Tire Yalınayak Hamamı men’s section <i>soyunmalık</i> domes in semi-circular profile.....	34
Figure 2.10. One-centered depressed profiles.....	34
Figure 2.11. Two-centered depressed profiles.....	35
Figure 2.12. Two-centered pointed profiles in the examined domes.....	38
Figure 2.13. Segmented profiles in the horizontal direction located in the <i>halvet</i> dome of Tire Hekim Hamamı men’s section.....	40
Figure 2.14. Segmented profiles in the vertical direction located in the <i>ılıkık</i> dome of Tire Hekim Hamamı men’s section.....	41
Figure 2.15. Segmented semi-circular profiles in the semi-dome of east side iwan unit of Tire Tahtakale Hamamı <i>sıcaklık</i> main space.....	42

Figure 2.16. Truncated-octogonal pyramidal, on the top circular depressed profiles in the dome of Urla Hersekzade Ahmet Paşa Hamamı women's section <i>sıcaklık</i> main space. ....	43
Figure 2.17. Square-pyramidal profiles in the dome of Tire Tahtakale Hamamı <i>aralık</i> space.....	44
Figure 2.18. Octogonal-pyramidal profiles in the square planned dome of northwest iwan of Tire Tahtakale Hamamı men's section.....	45
Figure 3.1. <i>Halvet</i> domes; (a) Kamanlı Hamamı, (b) Ulaş Hamamı.....	47
Figure 3.2. The domes of <i>sıcaklık</i> main space; (a) Tire Tahtakale Hamamı, (b) Düzce (Hereke) Hamamı, (c) Tire Yalınayak Hamamı, (d) Seferihisar Büyük Hamam. ....	47
Figure 3.3. <i>Ilıklık</i> main unit domes; (a) Tire Hekim Hamamı men's section, (b) Tire Tahtakale Hamamı men's section. ....	48
Figure 3.4. <i>Soyunmalık</i> dome (Tire Yalınayak Hamamı men's section).....	48
Figure 3.5. The distribution of examined domes according to the spatial components.....	49
Figure 3.6. The groups of domes in investigated baths according to spans.....	50
Figure 3.7. The range of domes according to their spans. ....	55
Figure 3.8. The number of domes in spatial components according to spans. ....	57
Figure 3.9. The distribution of examined domes with short, mid, and long spans according to spatial components.....	59
Figure 3.10. The plan of Tire Tahtakale Hamamı (taken from the archives of İYTE_The Department of Architectural Restoration, 2007) and the exterior view of superstructure. ....	61
Figure 3.11. The plan of Tire Hekim Hamamı and the exterior view of the <i>hamam</i> .....	61
Figure 3.12. The heights of examined domes according to the spans. ....	62
Figure 3.13. The relationship between span and height in all examined domes.....	68

Figure 3.14. The common relationship between span and height in the examined domes. ....	69
Figure 3.15. One row brick application in dome thickness. ....	77
Figure 3.16. Double row brick application in dome thickness. ....	77
Figure 3.17. Transition from double to one row brick along thickness.....	78
Figure 3.18. Thick plaster over one row brick in dome thickness. ....	78
Figure 3.19. The relationship between span and thickness in all examined domes .....	80
Figure 3.20. The common relationship between span and thickness in the examined domes. ....	81
Figure 3.21. Brick bond types in regular circular rows in the examined domes.....	84
Figure 3.22. In Urla Kamanlı Hamamı southwest <i>halvet</i> domes using the bond type of “ <i>horizontal stacking of the short side faces in places non-parallel rows</i> ” .....	85
Figure 3.23. Drawings of the bond type of “ <i>horizontal stacking of the short side faces in places non-parallel rows</i> ” .....	86
Figure 3.24. Drawings of the bond type of “ <i>horizontal and adjacent stacking of the short side faces in parallel rows</i> ”. ....	87
Figure 3.25. In Düzce (Hereke) Hamamı <i>soyunmalık</i> dome using the bond type of “ <i>horizontal and adjacent stacking of the short side faces in parallel rows</i> ” .....	88
Figure 3.26. Drawings of the bond type of “ <i>horizontal stacking of long faces on the bottom for a few rows and short faces on top in parallel rows</i> ” .....	89
Figure 3.27. In Tire Yalınayak Hamamı men’s section <i>sıcaklık</i> main space dome using the bond type of “ <i>horizontal stacking of long faces on the bottom for a few rows and short faces on top in parallel rows</i> ” .....	89
Figure 3.28. Drawings of the bond type of “ <i>random horizontal stacking of long and short faces</i> ” .....	91

Figure 3.29. In Tire Tahtakale Hamamı men’s section northeast <i>halvet</i> dome using the bond type of “ <i>random horizontal stacking of long and short faces</i> ”.....	91
Figure 3.30. Drawings of the bond type of “ <i>in vertical sequential stacking of long/short faces on interior, horizontal stacking of the long faces on exterior surface</i> ”.....	93
Figure 3.31. In Tire Karagazi Hamamı men’s section <i>sıcaklık</i> main space dome using the bond type of “ <i>in vertical sequential stacking of long/short faces on interior, horizontal stacking of the long faces on exterior surface</i> ”.....	93
Figure 3.32. Drawings of the irregular brick/stone bond type of “ <i>irregular brick/stone bond formed by stacking of brick and cut stone in random rows</i> ”.....	95
Figure 3.33. In the dome of Urla Hersekzade Ahmet Paşa Hamamı men’s section <i>ılıklik</i> space using the irregular brick/stone bond. ....	96
Figure 3.34. Drawings of the irregular stone bond type of “ <i>irregular stone bond formed by random and irregular stacking of rubble and cut stone</i> ”.....	97
Figure 3.35. A part of collapsed dome in Urla Hersekzade Ahmet Paşa Hamamı men’s section <i>sıcaklık</i> main space. “ <i>irregular stone bond formed by random and irregular stacking of rubble and cut stone</i> ” with horasan coating composed of large and small pieces of brick can be seen on the figure. ....	97
Figure 3.36. Distribution of brick bond types in domes.....	98
Figure 3.37. The relationship between span and height in all domes with the bond type of “ <i>horizontal stacking of the short side faces in places non-parallel rows</i> ”.....	102
Figure 3.38. The relationship between span and height in common domes with the bond type of “ <i>horizontal stacking of the short side faces in places non-parallel rows</i> ”.....	103

Figure 3.39. The relationship between span and height in all domes with the bond type of “ <i>horizontal and adjacent stacking of the short side faces in parallel rows</i> ” .....	104
Figure 3.40. The relationship between span and height in common domes with the bond type of “ <i>horizontal and adjacent stacking of the short side faces in parallel rows</i> ” .....	105
Figure 3.41. Oculus in the domes formed by placing terracotta pipes among brick bond.....	107
Figure 3.42. Oculus in the domes formed by shaping the brick bond.....	108
Figure 3.43. In the east <i>halvet</i> dome of Urla Kamanlı Hamamı, using hexagonal shaped oculi in circular three rows .....	109
Figure 3.44. The use of lighting cupola in the northeast <i>halvet</i> domes of Tire Tahtakale Hamamı.....	111
Figure 3.45. The use of lighting cupola in southwest <i>halvet</i> dome of Tire Hekim Hamamı men’s section .....	112
Figure 3.46. The use of top skylight in <i>sıcaklık</i> main space dome of Düzce Hamamı.....	113
Figure 3.47. The use of hexagonal oculi in ternary type in the <i>ılıkılık</i> main unit dome of Tire Tahtakale Hamamı.....	114
Figure 3.48. The use of hexagonal oculi in ternary and single orders alternately in the <i>sıcaklık</i> main space dome of Tire Tahtakale Hamamı .....	114
Figure 3.49. The use of hexagonal oculi in spiral geometrical order with star shaped in between randomly in the <i>sıcaklık</i> main space dome of Tire Yalınayak Hamamı men’s section.....	115
Figure 3.50. In Tahtakale Hamamı, in the interior surface of the depressed pyramidal dome of northwest iwan of <i>sıcaklık</i> main space, the use of eight-strand star ornament created with horasan plaster and placed oculus in each strand.....	116

Figure 3.51. In Tire Hekim Hamamı men’s section southwest <i>halvet</i> dome, the use of circular oculi on the curved surface of <i>halvet</i> dome and single oculus in each segment created in the dome. ....	116
Figure 3.52. In Tire Eski-Yeni Hamamı men’s section <i>sıcaklık</i> main space dome, the utilize of star shaped oculi in circular three rows and hexagonal shaped oculi in two rows on the lighting cupola at the top of dome.....	117
Figure 3.53. In Ulamış Hamamı west <i>halvet</i> dome, the use of hexagonal shaped in two circular rows on the curved surfaces and on the top an oculus in star shape. ....	118
Figure 3.54. In Tire Hekim Hamamı men’s section southeast <i>halvet</i> dome, for the purpose of space lighting penetrations the use of terracotta pipes in the brick bond.....	118
Figure 3.55. In Tire Eski-Yeni Hamamı <i>soyunmalık</i> dome, the use of lighting lantern.....	119
Figure 3.56. In Düzce Hamamı <i>soyunmalık</i> dome, the use of windows at the springing level. ....	120
Figure 3.57. The distribution and range of circular rows in the examined domes. ....	121
Figure 3.58. The relationship between span and the amount of oculi in all domes. ....	122
Figure 3.59. The relationship between span and the number of oculi in common domes.....	123
Figure 3.60. The relationship between span and the number of oculi in the first three circular rows from outside toward inside of domes.....	124
Figure 3.61. Transition elements to the dome and the relation.....	125
Figure 3.62. The relationship between span and height of transition elements in all examined domes .....	131
Figure 3.63. The relationship between span and height of transition elements in common domes.....	132



Figure 3.64. The relationship between span and height of exterior supporting elements in all examined domes.....	136
Figure 3.65. In the dome of ılıkılık/sıcaklık main space west sub-unit of Tire Hekim Hamamı women’s section, the use of horasan mortar including small and large pieces of bricks, stones, and tiles with traditional Turkish tiles covered on the exterior.....	137
Figure 3.66. The relationship between span and height of exterior supporting elements in common domes. ....	138

## LIST OF TABLES

<u>Table</u>		<u>Page</u>
Table 1.1.	The distribution number of the parameters dealt with morphological and construction techniques in short, mid and long-span domes .....	4
Table 2.1.	The distribution of profiles according to the dome spans. ....	28
Table 2.2.	The domes which have semi-circular profiles and depressed slightly than semi-circular profiles. ....	32
Table 2.3.	The distribution of transition elements according to dome spans in semi-circular profiles .....	33
Table 2.4.	The distribution of depressed profiles according to dome spans and the number of dome centers. ....	35
Table 2.5.	The use of depressed profiles in domes. ....	36
Table 2.6.	The distribution of transition elements according to dome spans in depressed profiles .....	37
Table 2.7.	The use of two-centered pointed profiles in domes. ....	38
Table 2.8.	The distribution of two-centered pointed profiles according to dome spans. ....	39
Table 3.1.	The spans of domes in spaces. ....	50
Table 3.2.	The long-span <i>soyunmalık</i> domes. ....	51
Table 3.3.	Short span domes of <i>ılıklik</i> sub-units. ....	51
Table 3.4.	The short and mid-span domes of <i>ılıklik</i> main units. ....	52
Table 3.5.	Short, mid and long-span domes of <i>sıcaklık</i> main spaces. ....	53
Table 3.6.	The short and mid-span <i>halvet</i> domes. ....	54
Table 3.7.	The distribution of domes in spaces according to their spans. ....	56
Table 3.8.	The distribution ratio of domes in spatial components according to spans. ....	57

Table 3.9.	Within the all domes, the distribution ratio of domes in spatial components according to their spans. ....	60
Table 3.10.	The distribution of heights of domes according to the spans. ....	62
Table 3.11.	The dome heights according to the spatial components. ....	63
Table 3.12.	The dome heights in long-span <i>soyunmalık</i> spaces. ....	63
Table 3.13.	The heights in the short and mid-span <i>ılıklik</i> main spaces' domes. ....	64
Table 3.14.	The heights in the short-span <i>ılıklik</i> sub-units' domes.....	64
Table 3.15.	The heights of short, mid, and long-span domes of <i>sıcaklık</i> main spaces. ....	65
Table 3.16.	The heights in the short and mid span <i>halvet</i> domes. ....	66
Table 3.17.	The thicknesses of the examined domes according to the spans.....	71
Table 3.18.	The thicknesses of domes at the springing level according to the spatial components.....	72
Table 3.19.	The thicknesses of long-span <i>soyunmalık</i> domes at the springing level.....	73
Table 3.20.	The thicknesses of short and mid-span <i>ılıklik</i> main unit domes at the springing level.....	73
Table 3.21.	The thicknesses of short-span <i>ılıklik</i> sub-unit domes at the springing level. ....	74
Table 3.22.	The thicknesses of short, mid and long-span <i>sıcaklık</i> main space domes at the springing level. ....	74
Table 3.23.	The thicknesses of short and mid-span <i>halvet</i> domes at the springing level. ....	75
Table 3.24.	Distribution of bond types in domes.....	99
Table 3.25.	Domes constructed with the bond type of “ <i>horizontal stacking of the short side faces in places non-parallel rows</i> ”. ....	100
Table 3.26.	Domes constructed with the bond type of “ <i>horizontal and adjacent stacking of the short side faces in parallel rows</i> ”. ....	101

Table 3.27. The number of oculi rows and range in dome.....	122
Table 3.28. The distribution of transition elements to the domes in spaces according to their spans.....	128
Table 3.29. The distribution of transition elements to the domes in spaces.....	129
Table 3.30. The distribution of transition elements in spatial components.....	130
Table 3.31. The use of exterior supporting elements in the spatial components.....	134
Table 3.32. The distribution of exterior supporting elements in spatial components according to the dome spans.....	135

# CHAPTER 1

## INTRODUCTION

### 1.1. Aim and Content of the Study

Ottoman baths that have undertaken an important part of daily life during the Ottoman period were built as social structures of all the settlements. Domes are the superstructure of square planned *soyunmalık*, *ıhlık*, main unit of *sıcaklık* main space and *halvets* in the Ottoman bath architecture, which makes dynamic mass order by means of being juxtaposed to each other with different numbers and sizes on the exterior while creating rich places by means of lighting elements placed on the dome in various arrangements in the interior.

The purpose of this study is to examine the domes sampled in a group of Ottoman baths located in the settlements of Western Anatolia in point of architectural characteristics and original construction techniques and to evaluate the features of domes for the purpose of producing information in order to preserve the original qualities.

In this context, domes were examined in conjunction with the transition elements of the dome, external support elements and in the integrity of the dome. The relationship network dealt with architectural features and construction techniques were investigated in detail and evaluated by means of using statistical analysis methods. Afterwards, evaluation of the collected information related to both dome construction characteristics and the relationship between morphological features and construction techniques were transferred into the content of the thesis as descriptively and graphically with a comparison study.

Field surveys were made using traditional and photogrammetric measurement techniques, and it was supported by sketches and photographic works.

Domes were hitherto the subject of investigation and research consistently. Although structural features of domes and construction technology have been studied in many studies, most investigations have been limited with examination of only single instance (Özer 1988; Güngör 1988; Karaesmen and Unay 1988; Mungan 1988;

Çamlıbel 1998; Günay 2006). These studies have mostly been made to identify the structural features of the domes on the contrary to investigate architectural features in detail. The lack of study on examination of the architectural features in detail is a remarkable case. Additionally, the examined baths in the thesis were investigated and evaluated previously in terms of architecture and art history topics (Akyıldız 1988; Çakmak 2002; Armağan 1983 and 2003). These studies mostly focused on the construction dates and plan features were introduced. In addition, the baths were investigated in terms of construction techniques and material use. In these studies general definitions were introduced and the baths were evaluated in terms of construction techniques (Reyhan 2004; Reyhan and İpekoğlu 2004, 2006). However, in all these studies the domes were not investigated in detail.

One of the goals of the thesis is to examine architectural characteristics and construction techniques in detail, which is lack of these previous studies, and to analyze and evaluate the collected information by means of statistical analysis techniques. Consequently, it may be determined the relationship network among architectural characteristics and construction techniques. In case of classification these relations are respectively; dome span-dome height both in all domes and in common domes in terms of bond types, dome span-dome thickness relation, examination of lighting orders in detail and dome span-the number of oculi relation, the distribution of transition elements in domes and dome span - the height of transition elements, the use features of exterior support element and dome span – the height of exterior supporting elements.

In addition, this dissertation will make important contributions in point of covering lack of knowledge in the studies in terms of architectural characteristics and construction techniques of dome superstructures. Moreover, this dissertation will make contribution in the constitution of knowledge in detail in terms of restoration project for the purpose of conservation of historic bath domes.

In the general sense, this case is of great importance to keep in safe the original dome construction details within the conservation works during repairs.

Examined baths were located in the small settlements of western Anatolia in Tire town center, Urla and Seferihisar town centers and in the villages nearby the town centers. Although the baths have no inscription panels, they can be dated back to the 15<sup>th</sup> and the 16<sup>th</sup> centuries according to their authentic architectural characteristics (Reyhan 2004; Reyhan and İpekoğlu 2004, 2006).

In this dissertation, the scope of study was determined as geographical borders of Tire, Urla and Seferihisar town centers and nearby village settlements to the town centers, and the domes of Ottoman baths located in these geographical borders with the construction date of the 15<sup>th</sup> and the 16<sup>th</sup> centuries. In this case, seventeen baths were selected as the subject of the thesis. These are respectively; Urla Hersekzade Ahmet Paşa Hamamı, Urla Kamanlı Hamamı, Urla Rüstem Paşa Hamamı, Urla Özbek Köyü Hamamı, Seferihisar Büyük Hamam, Seferihisar Küçük Hamam, Sığacık Kaleiçi Hamamı, Düzce (Hereke) Hamamı, Ulamış Hamamı, Tire Hekim Hamamı, Tire Tahtakale Hamamı, Tire Yeniceköy Hamamı, Tire Karagazi Hamamı, Tire Yalınayak Hamamı, Tire Şeyh Hamamı, Tire Eski-Yeni Hamam, and Tire Mehmet Ağa Hamamı.

The baths have no inscriptions stating the exact dates of construction. But according to its endowment dated 845 / 1442, it can be said that the Tahtakale Hamamı was built in the fifteenth century (Armağan 2003; Çakmak 2002). According to their architectural characteristics, Urla Hersekzade Ahmet Paşa Hamamı, Kamanlı Hamamı, and Hekim Hamamı date back to the fifteenth century, as well. In this date setting characteristics such as, the spatial organization of the square planned dome covered *ılıklik* space is enlarged with a vault covered unit on one direction, and the decoration features such as the muqarnasses formed by the brick construction material by using geometrical and plantal patterns formed by plaster in the transition zones to the dome are pointed out. Özbek Köyü Hamamı, Seferihisar Büyük Hamam, Küçük Hamam, Sığacık Kaleiçi Hamamı, Ulamış Hamamı, Düzce Hamamı, Tire Eski-Yeni Hamam can be dated back to sixteenth century in accordance with their architectural characteristics. To point out this date for these domes, architectural characteristics such as the enlargement of the square planned dome covered *ılıklik* space by two sub-units covered with vault or dome, window alignment on the *soyunmalık* walls, tile covering over the dome and vault top coat, niches on the *ılıklik* and *sıcaklık* are important instruments (Önge 1995).

In the examined baths in terms of dome architectural characteristics and construction techniques, the account distribution parameters that were investigated can be seen in Table 1.1.

In the data collected from 17 baths, there are 79 domes in total. Of 79 domes, 45 domes are with short-span, 27 are with mid-span and 7 are with long-spans. In all domes, the dome span have been determined, whereas excluding 13 collapsed domes in the 66 domes dome height, profile type and lighting elements arranged on the domes

have been determined. Of 79 domes, in the 78 domes the type and height of transition elements, in 72 dome thicknesses, in 67 bond types and finally 31 the height of exterior support element have been determined and examined in the point of their sections. Fourteen of 67 domes were not analyzed by means of statistical simple-regression with the response of being residuals and in single uses. Consequently, the 53 domes that have the common two bond types have been analyzed by means of statistical methods and evaluated in terms of dome span-dome height relation (Table 1.1).

In the content of the thesis, the examinations and evaluations that dealt with architectural constructions and construction techniques are respectively; dome span, dome height, dome thickness at the springing level, bond type and in the domes with the common bond types in point of the relationship between dome span and dome height, the number of oculi placed on the dome and the rows of oculi, the type of transition elements to the domes, and the exterior supporting element in order to respond what they are and how they were built up in the dome architecture.

Table 1.1. The distribution number of the parameters dealt with morphological and construction techniques in short, mid and long-span domes.

<b>Parameters</b>	<b>Short-span domes</b>	<b>Mid-span domes</b>	<b>Long-span domes</b>	<b>Total</b>
<b>Dome number</b>	45	27	7	79
<b>Examined dome number</b>	39	20	7	66
<b>Unexamined (collapsed)</b>	6	7	0	13
<b>Profile types</b>	39	20	7	66
<b>Dome span</b>	45	27	7	79
<b>Dome height</b>	39	20	7	66
<b>Dome thickness</b>	42	23	7	72
<b>Bond type</b>	44	17	6	67
<b>Evaluated bond type</b>	33	14	6	53
<b>Oculi number or the row number</b>	39	20	7	66
<b>The type of transition elements</b>	44	27	7	78
<b>The height of transition elements</b>	44	27	7	78
<b>The height of exterior support elements</b>	10	14	7	31



Each parameter has been examined in three steps; the first is composed of the investigations in detail within all domes, the second step is analyzing and evaluating with relation to the dome span by means of using statistical multi-regression methods, and the last step is designed as arguing the similarities and differences among dome architecture in general.

The architectural characteristics are dealt with dome span that provides the geometry of the dome, dome height, number and organization of lighting elements on the dome, the type and height of transition elements to the dome, the form and height of exterior supporting elements. Architectural characteristics are the knowledge of the formation and order features of the morphological components. However, regarding construction techniques is associated with the knowledge of bond type and bond arrangements, and also dome thickness. They are the data of bond types, the sizes and forms of constructional materials within the bonds, and application methods.

Domes have been classified within three groups according to their span. These are respectively; short span *ılıklik*, *sıcaklık* main space and *halvet* domes between 0.95-3.45 meters, mid-span *ılıklik*, *sıcaklık* main space and *halvet* domes between 3.5-5.95 meters and long span *sıcaklık* main space and *soyunmalık* domes 6 meters and longer. The dome thickness at the springing level of all domes vary between 35 and 75 centimeters while almost in all domes are stable between 35 and 40 centimeters at the top.

The bond can be classified in three main designs in masonry dome structures; the brick bonds with the regular stacking radials towards the dome center in five different diversities, irregular stone bond, and combined bond of stone and brick irregularly and in random stacking. The primary material in the dome construction is brick and secondary is stone in a few cases rarely with lime mortar as binder. Additionally, terracotta pipes (*pöhrenk*) have been used as regarding to lighting system with use within the brick bond. Moreover, all domes have been covered with horasan plaster, thin layer interior and thick layer exterior of the surfaces. In rare instances, over the horasan a 10-15 centimeters thick horasan coating including small and large pieces of bricks, stones and traditional Turkish tiles covered over the end of coating.

The lighting in the examined domes was obtained by use of lighting elements arranged on the domes in the brick bond. In general, in long-span domes at the top there is lighting lantern as single lighting elements on the dome and in rare depressed pointed windows at the springing level may be seen. In the mid and short span *ılıklik*, *sıcaklık*

main space middle unit and *halvet* domes, at the top either hexagonal top skylight and on the curved surfaces oculi or lighting cupola made of half brick bond with oculi on the curved surfaces. The oculi that are original structural element and ornament designs have been formed by means of either terracotta placed in-between bonds or arrangements of bonds themselves.

Pendentives are commonly used in all domes as the transition element to dome interior. In addition, all long-span domes and most of mid-span domes have been supported by means of exterior supporting element.

As a result of analyses and evaluations, it is pointed out that there are positive (linear) relationships between dome span and dome height, dome span and the number of oculi, and that there is a ratio between dome span and dome thickness, dome span and the height of transition elements, dome span and the height of exterior supporting elements. Consequently, the case is pointed out that in the domes there are positive (linear) relationship between architectural characteristics and construction techniques.

The examination of original construction technology of domes in Ottoman bath architecture, which constitute dynamic outside mass order, and producing knowledge in this area in details in regard to the architectural characteristics and construction techniques are important in terms of attention on the original construction features during the conservation works for the purpose of maintenance of the historical dome construction. Moreover, the goal of the thesis is also to cover lack of knowledge in this subject and to get attention on the studies for carrying original historical buildings to the future.

## **1.2. Methodology**

In the scope of the study; regarding the original morphological characteristics, construction techniques and use of material in the domes, transition and exterior supporting elements have been examined by means of field surveys and obtained data have been analyzed and evaluated using statistical simple linear regression methods.

The main criteria for selecting instances are to be able to examine the construction characteristic of the domes. In case the original features of the samples have been deceived by means of vandalism or outer interventions these samples have not been placed in the investigation. Of examined 17 baths, the 13 domes (Urla

Hersekzade Ahmet Paşa Hamamı, Urla Kamanlı Hamamı, Urla Rüstem Paşa Hamamı, Seferihisar Küçük Hamam, Sığacık Kaleiçi Hamamı, Düzce (Hereke) Hamamı, Ulaş Hamamı, Tire Hekim Hamamı, Tire Tahtakale Hamamı, Tire Yeniceköy Hamamı, Tire Karagazi Hamamı, Tire Yalınayak Hamamı, and Tire Şeyh Hamamı) have been examined in all subjects, whereas 4 domes (Urla Özbek Köyü Hamamı, Seferihisar Büyük Hamam, Tire Eski-Yeni Hamam, Tire Mehmet Ağa Hamamı) have been examined partially. Of these four domes, two domes (Tire Eski-Yeni Hamam and Tire Mehmet Ağa Hamamı) have been examined in terms of lighting system, while the other two domes (Urla Özbek Köyü Hamamı, Seferihisar Büyük Hamam) only examined in terms of morphological characteristics.

Investigations are composed of three main groups such as each parameter mentioned above; the first section is composed of the investigations in detail, the second is analyzing and evaluating with relation to the morphological characteristics and construction techniques by means of using statistical simple linear regression methods, and the last one is arguing the similarities and differences among dome architecture in general literature.

In addition, the catalogue for each bath have been prepared and obtained information and data have been evaluated in comparison study regarding architectural characteristics and construction techniques both in each dome. The samples are composed of four parts in the catalogue: construction date, spatial characteristics, construction techniques and material use, and construction situation of each dome in systematic sequences. In the part of construction techniques and material use there are transition elements and exterior supporting element in detail investigated and evaluated the relationships in-between as sub-heading.

Field surveys were performed by means of using conventional measured techniques and using electronic total-station, and they are supported by using free-hand sketch drawings and taking photographs. Moreover, both vertical and horizontal measures of the survey performed by conventional techniques were controlled by use of laser-meters. Obtained data were transmitted to digital using *AutoCAD software* programs for the each subject in varied scale and placed in-between regarding text. In case of disabled measured parts, by means of references on the photographs were completed the drawings. For the plan 1/100, for the dome sections 1/20 and for details 1/5 scaled drawings were prepared and placed within the texts. Additionally, in the text the tables were prepared in order to make the text more understandable.

The remainder of the dissertation is organized as follows. Chapter 1 consists of sources and terminology in addition aim and content of the study previous. Chapter 2 presents definitions and profiles. Examination and evaluation of the architectural characteristics and construction techniques of the domes are described in Chapter 3. Chapter 4 concludes the dissertation and gives brief summary of the dissertation. Last part of dissertation is the Appendix A which includes bath samples in detail.

### **1.2.1. Sources**

Masonry domes have been the subject of many national and international studies and research from the past to the present. In these studies and research, architectural features, construction techniques, material usage, material properties, and structural features of domes were investigated up to this time. These can be classified under three main groups:

- The first group is the studies and research on domes in general, which focused on the architectural and structural characteristics of domes (Fontana 1694; Heyman 1967 and 1977; Hager 1973 and 1975; Yorulmaz and Ahunbay 1986; Özer 1988; Güngör 1988; Karaesmen and Unay 1988; Mungan 1988 and 2009; Robison 1989; Huerta 1990; Turan 1993; D.D' Ayala 1993; Ignatakis, Stylianidis and Stavrakakis 1993; Hidaka, Aoki, and Kato 1993; Menditto and Betti 1993; Karaesmen 1993; Escrig and Valcarcel 1995; Çamlıbel 1998; Fielden 2001; Altın 2001; Cerutti Fusco and Villanni 2003; Lopez Manzanares 2003; Mozo 2003; Bilgin 2005; Günay 2006; Fahjan 2006; etc).

As a contribution to the thesis, the studies mentioned above were examined to determine the similarities and differences between the common domes and the domes of examined baths in terms of architectural characteristics and construction techniques. This dissertation confirmed the relationships of dome components between each other and about how they were formed.

- The second group is composed of studies on the specific examined Ottoman baths (Akyıldız 1988; Armağan 1983 and 2003; Çakmak 2002; Çizer 2004; Uğurlu 2005; Reyhan and İpekoğlu 2004, 2006, 2010).

In this context, the studies dealt with examining the architectural features, construction techniques, materials usage and properties of the material of the examined

baths. Such information obtained through the studies, which are related to the domes, is one of the important resources that contribute to the thesis.

- The third group includes the measured survey studies and photographs of the examined baths, some of which were used with revision (Reyhan and Çizer 2001; Çakmak 2002; Reyhan 2004; Kaplan, Murtezaoğlu and Saygı 2007; Korkmaz and Dereli 2009).

### **1.2.1.1. Studies on Domes in General**

The first group of studies made on the domes in general can be evaluated within two different disciplines about architectural and structural features of domes. The architectural features and construction techniques are discussed within the discipline of architecture, while the research studies on the structural behavior is discussed within the discipline of engineering. Architectural features of the domes are also the morphological features of the domes. Morphological characteristics dealt with the geometric features of the domes, which were determined by profile, span, height, the shape, the number and the order of oculus formed in the domes, transition element and the exterior supporting element. Structural features include; bond types of the domes, properties of construction techniques that were determined by materials usage and the thickness, and the structural behaviors of the domes under different loads.

Looking at the overall work done on the domes, it is seen that architectural features of domes were identified and evaluated through examples of singular structures. The content of the studies do not include the relationships of the components that form the dome between each other and their place and peculiarity within the general dome architecture. The evaluations have been limited merely with the definition of architectural features and structural condition of the domes. In these studies, the relationships between the members of the dome that dealt with morphological characteristics remained mostly outside the scope of research. A detailed examination of architectural and structural features of the domes is necessary to fill the gap in this area. This is one of the main objectives of the thesis. Thus, the bilateral relations of the components of a dome and the formation of these relationships were shown in detail.

### ***1. Studies on determination of architectural features:***

These studies include the geometric layout of buildings, examinations on morphological properties, construction techniques and material usage, analyses, examinations and evaluations (Fontana 1694; Heyman 1967 and 1977; Yorulmaz and Ahunbay 1986; Özer 1988, Güngör 1988; Karaesmen and Unay 1988; Mungan 1988 and 2009; Turan 1993; D.D' Ayala 1993; Escrig and Valcarcel 1995; Altın 2001; Cerutti Fusco and Villanni 2003; Lopez Manzanares 2003; Mozo 2003; Günay 2006; Fahjan 2006; etc).

These studies on architectural characteristics can be classified under two groups according to the use of the dome. These are:

- the studies on domed masonry structures,
- the studies made on structural elements such as vaults and arches, but also including information on domes.

Domed structures that are subject to investigations by the first group are the structures that have a dome as superstructure, such as mausoleums, mosques, *medrese* (religious schools). Domes show different variations according to the geometric properties such as elliptical, oval, depressed, semi-circle, pyramid, segmented.

Domes have been used as space covering structures in every geographical region from Roman times to the present architecture, and have been developed with the original traditional architectural features and construction techniques of each region. Better understanding of architectural and constructional characteristics of the domes in Ottoman baths that were built in Western Anatolia is possible with investigation of other national and international domed structures. There are studies, for instance, made by Fontana (1694) in Rome, later Hager (1973 and 1975), Huerta (1990), Lopez Manzanares (2003).

Fontana's studies were introduced by Lopez Manzanares (2003) with an article in the name of "*the XVII<sup>th</sup> century: Carlo Fontana's expertises*". Fontana introduced by Lopez Manzanares, built the dome of Fontana, Santa Margherita in the Montefiascone. Fontana's book published in 1694 (*II Tempio Vaticano e sua Origine: a diffuse description of the basilica of Saint Peter*) contained some simple geometric rules about the construction of the dome. In addition, the structural strength of the dome of Saint Peter was analyzed in this study.

Fontana conducted studies on the domes about the dome thickness at the springing level and at the top of dome, drum thickness and the relationships of overall proportions, and the geometric rules (features) of the domes.

In the investigations, the structural situation was merely explained by the relationship between span and thickness, and increasing the thickness in the springing level of dome was presented as a solution against the structural problems (the failure, collapsing or cracking). These studies were lack of several issues that were not examined such as; whether the structural condition was affected by different variables, what the variables are and in which way these variables were affected.

There are so many studies on understanding the architectural characteristics and construction techniques of the Ottoman dome architecture. The main ones of these studies are on the domes built by Sinan. The symposium held in 1988, "*Domes from Antiquity to the Present, IASS-MSU*", is one of the important works which are related to Sinan domes. In symposium proceedings, the works of Ozer (1988), Güngör (1988), Karaesmen and Unay (1988), and Mungan (1988), who are important researchers on Sinan domes, give important information on the period of examined dome architecture. In addition, Nafiz Çamlıbel (1998), in the book of "*Sinan Mimarlığında Yapı Strüktürünün Analitik İncelenmesi (Analytical Study of the Structure of Building in Sinan Architecture)*" examined domes of Mimar Sinan mosques in detail.

In the study of Cerutti Fusco and Villanni (2003), "*Pietro da Cortona's Domes between the New Experimentations and Construction Knowledge*", the domes built by Cortona were examined. In their article, the domes that were built between 1647 and 1668 were analyzed and modeled, and construction problems of the domes were identified. Thus, comprehensive information was formed on building process and the structure of the domes. At the same time, this study provided a detailed knowledge on the structure of Baroque and Rococo-style domes built in Europe. The study is important that it gives information on construction techniques of domes in Baroque and Rococo period in Europe. Thus, in the aspects of building features, it will be possible to make comparison between the Turkish baths domes built during the Ottoman period and the domes of architectural works in Europe at that time.

The study of Mozo (2003), "*Extradosed vaults in the Monastery of el Escorial: The Domes at the Church Towers*", was an examination made on the domes of the church towers. In the study, theories of dome construction techniques were developed

through the dimensions of the domes. This study can be considered as a sample review made on the domes of church towers.

The content of work of Escrig and Valcarcel (1995), "*Influence of Constructive Systems in the Structural Performance of Ancient Domes*", was formed through analyzing the building technology and structural behavior of construction technology and structural behavior of domed-structures that have different typologies. The analyses were formed by verbal descriptions in the article.

The study of Altın (2001), "*The Structural Analysis of Domes: from the Pantheon until the Reichstag*", deals with development process of different-dimensioned domes of the buildings through examining construction techniques, materials usage, and constructional characteristics. The buildings in which he studied were; two-thousand-year period (27BC-2000AD) the Pantheon, Hagia-Sophia, Florence Cathedral, Saint Peter's Cathedral, St Paul's Cathedral in London, the Reichstag. In the article, it is stated that, construction techniques and stylistic features of the structures were affected by the material properties and the capacity. Span, height, construction materials, construction date, and constructional characteristics of the domes were taken into account in the examinations.

Günay (2006) examined the dome supporting system of the buildings of Sinan in his "*Architectural Analysis of Sinan Buildings*" titled study, through taking into account the numerical data (values) of earlier studies of N. Çamlıbel, M. Yorulmaz, A. Kuran, and A. Ülgen. The strength of the supporting system was assessed with dome lowness (dome height / dome span) and the dome central angle along dome curving, in the study. Yorulmaz (1986) made numerical evaluations related to domes, in the study examining the elements of supporting system used by Mimar Sinan in his mosques. The study is stated that the majority of the mosques (the 17 among 25 mosques) had dome span ranging from 11.50 to 14.00 m, and the study also indicates the ones that had different value of dome span.

Ahunbay (1986) examined the construction techniques and material usage of the constructional elements of Sinan buildings. According to Ahunbay, bricks were located through center in radial in the curved surfaces of the domes, and bricks bond were raised up to the top into domes. Ahunbay, in addition, also stressed that the dome thickness varies according to the span of the dome (Ahunbay 1986, p.131).

Mungan (2009), in the first phase of work, made definitions of Hagia Sophia, and he evaluated periodic development assessments of dome structure. In the study, the



structural conditions of Pantheon and Hagia Sophia were compared. In the second phase, structural analyses of Hagia Sophia were defined. In the last stage, the current problems of Hagia Sophia were indicated, and an appropriate structural strengthening of the building was proposed.

In the second group of the studies; made by Batur (1974) and Yavuz (1983 and 2002), Yorulmaz and Ahunbay (1986), Kolay (1999), Bakırer (1995), and Uluengin (2001), which were related to superstructure or supporting elements of superstructure, hold an important place. Batur, in the study of "*Arch in Ottoman Mosques*", examined the relationship between construction and morphology dealing with the arches. Yavuz (1983), in the study of "*The Vault and the Arch in Anatolian Seljuk Architecture*", made investigations on construction techniques and morphological characteristics of arches and vaults. In addition, Bakırer (1995) studied on building materials in Anatolian Seljuk Architecture, and Yavuz (2002) examined building properties of this period, in detail. Yorulmaz and Ahunbay (1986), in their study examining structural system and construction techniques of Sinan Mosques, inform about support system, construction technique, and material usage. Kolay (1999) examined construction techniques and material usage of Emirates architecture in Western Anatolia dated back to 14<sup>th</sup> century. Uluengin (2001) informs about construction details related to the Ottoman architecture. These studies are important for the thesis taking into account of including sub-sections related to domes.

## ***2. Studies related to determine the structural features:***

In the studies carried out within the discipline of engineering, structural behavior of the domes were analyzed and evaluated with mathematical modeling and finite element method (Hager 1973 and 1975; Robison 1989; Huerta 1990; Ignatakis, Stylianidis and Stavrakakis 1993; Hidaka, Aoki, and Kato 1993; Menditto and Betti 1993; Karaesmen 1993; Çamlıbel 1998; Fielden 2001; Bilgin 2005; etc). Additionally, in the content of the studies; prototype of that reflects general typology of the dome was improved, and the dome was analyzed and tested on the mathematical modeling techniques.

Computer-based analysis theorems (*limit analysis theorems*) were developed by first Straub (1952), and then Huerta (1990) (Lopez Manzanares 2003). Today, computer-based analysis methods enable to determine structural behaviors of domes under own load or moving loads such as earthquake load. In this case, the necessary

data will be provided to determine the possible damages that may occur in domes under these loads, and to improve interventions and protection against these threats. All around the world, analyses are made to determine the structural behaviors in the earthquake area, within the scope of protection of historic dome structures.

Structural analyses can be examined under two headings; structural analysis of individual buildings and structural analysis of a group of buildings. In both cases, the analyses are the studies made for the case of each building within engineering discipline. For singular examples; structural modeling is carried out with analytical investigations or with the help of a finite element model. Structural analyses of a group of buildings are based on analyzing each building individually and on comparison to the results with each other.

The analytical investigations made by Çamlıbel (1998) on domes of Sinan mosques (13 Mimar Sinan mosques' domes), constitute an important example of studies of a group of buildings. In the study, analytical investigations were made for the dome of each mosque and the stabilities of the domes were mathematically calculated. Domes were evaluated with a comparative study, in addition to the analytical assessments. Çamlıbel (1998) in his book emphasized that Mimar Sinan used a method to decrease tensile stresses on the domes as he thickened springing level of the domes twice in comparison to the top of the dome. This situation explains the reason that thickness on the springing level of the domes is more than the thickness at the top of the dome, also for the domes in the examined Ottoman baths.

D'Ayala (1993) aimed to identify the mechanical behavior of the dome structure to and sub-structural connection with the parametric and structural analysis, and to determine a safe level. The study focused on construction technique and form of the Italian Renaissance and Baroque domes. The study underlined that structural behavior of the domes (transferring their loads from the dome to the sub-structures) are related to the geometric properties of the domes and the transition elements. In other words, analyses conducted on the domes that have 12 to 21 meters span showed that; span, thickness, and volume of the domes determined the structural behavior.

Bilgin (2005) conducted works about geometric dimensions of Istanbul Şehzade Mosque, one of Sinan's buildings, and made static analyses of semi-dome and half domes combinations with *SAP2000 Structural Analysis Program* based on the finite element method, in the study named "*Structural Behavior of Space Cover Systems for Domed-Buildings of Sinan*". As a result of the analyses, it was emphasized that

structural mutual interaction of the main dome, arch, semi-dome and pendentive were stated, and structural behavior of each system was stated numerically. In addition, all systems were compared with each other.

Turan (1993) emphasized masonry shell structures in his study, and indicated that diversity of the transition elements in such buildings was caused from construction technique and materials that form geometry and structure. In the article, structural behavior of the domes and transition elements under the stable and dynamic loads were analyzed. In the study, structural behavior related to the transition elements, for the shell systems such as dome. Turan classified the buildings that had shell systems, according to their dome support system (sub-structure). He made comparisons between transition elements of the dome, such as pendentive, squinch, and Turkish triangles, and claimed that Turkish triangles transmitted the loads from the dome in equal proportions (uniform) to the sub-structure that are walls and foundations (p.343).

Ignatakis, Stylianidis and Stavrakakis (1993) briefly introduced formal and structural characteristics of the Byzantine domes in the articles named "*Design of the Interventions in the Domes-The Importance of Consideration of Cracking*". At the same time, the article mentions about the structural behavior of domes under vertical loads and seismic loads, possible damages on the domes caused from these loads, and confirms about the reinforcement methods. In the article, two protection interventions for the dome of St. Panteleimon Church in Thessaloniki were discussed as an example. The examination of the structural behavior of the dome was based on numerical analysis. Concerning geometric dimensions of the dome, it was indicated that the ratio of elevation to openness was 0.43 (2.50 / 5.80). This ratio has similarities to the baths examined in the thesis (0.40 to 0.48). Thus, the ratio was used to determine the ratio of height to span for the domes of Ottoman baths.

Karaesmen (1993), in his work named "*A Study of the Sinan's Domed Structures*" conducted analyses with finite elements model to determine structural behavior of Sinan's domes under earthquake and its load. A similar study was presented in the article of Hidaka, Aoki and Kato (1993), named "*Structural stability and Profile in the dome of Santa Maria del Fiore, Florence*".

In the study of Menditto and Betti (1993), "*Analysis and Mathematical Simulation of the Dome of Urbino Cathedral*", problems for the dome of Urbino Cathedral observed with the thermal imager, and the finite element method and

mathematical simulations were used to analyze the structural behavior of the dome under loads.

Huerta (2001) while studying the balance of vaults he informed about structural system of domes in his essay, "*Mechanics of Masonry Vaults. The Equilibrium Approach*". According to Huerta, the first numerical modeling of domes (structural analysis) was for the structural behavior of Saint Peter's dome in Rome. This modeling was defined by three mathematicians, Jacquier, Le Seur and Boscovitch (1743). Huerta emphasized that Heyman (1967, 1977) was the person, who revised the technique used, and developed theoretical approaches with his work named "*Limit Analysis*". The first report on the border thickness of the domes was carried out by Kobell (1855). And Beckett (1871) was the first to examine the collapse mechanisms of the domes. Beckett stated that his study was based on the analysis of historical structures in terms of stability and security, made by Heyman. In addition, he emphasized that geometrical rules of Fontana (1694) were applied for structural analysis.

#### **1.2.1.2. Studies on Domes of the Baths that are Subject of the Thesis**

The most important sources of the second group studies and fundamental sources of the thesis are the domes themselves. Architectural characteristics and construction techniques of the baths, subject to the thesis, have been examined since 2002, and since 2007 the studies have been intensively focused on their domes. As a result of these investigations, definitions and analyses were first made through data collection formal dealt with architectural characteristics and construction techniques of the domes, and then evaluations and inferences based on comparative study and statistical analyses were made. In the first step, each dome was examined for morphological characteristics, such as span, height, lighting elements in the dome in terms of the sequences and number of oculi, type and height of transition elements, the height of exterior dome supporting element, and examined for construction techniques such as thickness and bond types. In the second step, taking into account all data collected within the first step, each relationship between dome span as stable and dome height, dome thickness, the number of oculi arranged on the domes, the height of transition elements, and the height of exterior supporting elements respectively were examined utilizing statistical analyses techniques of multiple regressions and evaluated.

The second group of studies may include the investigations on a group of baths among the examined baths. The main studies on these Ottoman baths are dealt with; architectural and historical features (Akyıldız 1988), construction techniques (Reyhan 2004; Reyhan and İpekoğlu 2004, 2006) and material properties (Çizer 2004; Ugurlu 2005) of the baths located in the centers of Urla and Seferihisar and nearby village settlements, additionally architectural and historical features of the baths located in the center of Tire (Armağan 1983 and 2003; Çakmak 2002). These studies are mostly focused on definitions of architectural features and construction techniques with comparative analyses in general. Consequently, the similarities and differences were clearly revealed.

The study of Akyıldız (1988) in Seferihisar and Urla, the study of Armağan (1983 and 2003) and Çakmak (2002) in Tire, defined and evaluated architectural and historic properties of the baths. These baths were built in the 15<sup>th</sup> and the 16<sup>th</sup> centuries according to the articles, which are based on architectural characteristics and historical properties. In these studies, architectural and historical features of the baths were assessed by reference to the works of S. Eyice (1960) and Y. Önge (1995).

In the works of Reyhan and İpekoğlu (2004, 2006) about construction technique and the material usage, Ottoman baths in Urla and Seferihisar were examined and evaluated in terms of construction technique and material usage. According to these investigations:

- the domes of the examined baths were made of local materials and construction techniques, and have modest dimensions.
- brick was commonly used as a construction material of the domes.
- for all of the domes, the lime mortar was used as binding material, and horasan mortar was used as insulating material of interior and exterior surfaces of the dome.
- in the brick bond, terracotta pipes were used for lighting purposes.

Çizer (2004), in her study under the master's thesis, examined the properties of lime mortars used in the domes of Ottoman baths in Seferihisar-Urla region. For the study of mortars the structural features of the domes were taken into account. As a result, it is stated that all lime mortars used in domes were hydraulic lime mortars. This study indicated that there was a traditional mortar construction technique for the baths in Seferihisar and Urla.

Uğurlu (2005), in his study under the master's thesis, examined the properties of horasan plasters used in some Ottoman baths in Urla and Seferihisar. The study indicated that plaster horasan used as a coating material had hydraulic properties. This study is important to show that special bricks were produced to use in plaster making, and horasan plaster was extensively used in the domes that were plastered inside and outside.

The main goal of this dissertation is to cover lack of knowledge about morphological characteristics and construction techniques of the domes in the Ottoman baths and additionally, to analyze the relationship between morphological characteristics and construction techniques which hitherto lack of previous studies of the baths.

### **1.2.1.3. Measured Surveys and Photographs**

In the third group of studies, measured surveys prepared for the documentation and identification of the baths, and photogrammetric works have importance. Measured surveys were obtained from the studies made in the content of IYTE Department of Architectural Restoration, Graduate Program, RES502 Architectural Restoration Design II course within the scope of Spring semester Academic Education Year 2001-2002, "*Seferihisar Büyük Hamam Restoration Project*" (K. Reyhan and Ö. Çizer), 2006-2007 Academic Education Year "*Tire Tahtakale Hamamı Restoration Project*" (Ç.D. Kaplan, F. Murtezaoğlu and G. Saygı), and 2008-2009 Academic Education Year, "*Urla Kamanlı Hamamı Restoration Project*" (D. Korkmaz and K. Dereli). Prepared the plan and section drawings of the baths were revised and used in the relevant sections of the thesis. Some photographs of domes taken in these studies were also included in the thesis with references. Drawings and photographs that do not have references in the thesis are the works made for the thesis.

### **1.2.2. Terminology**

Terminology for the types of domes is developed and often used in the format based on the geometric layout and morphological definitions. The terminology that is developed for the domes can be classified in two different variations: geometric and

volumetric formations. These are usually; vertical cross-section profiles that are formed by the center circle arc or arcs with number of centers and the definitions based on volumetric formations in a few samples. They are both used together in the thesis. The profiles based on the center circle arc or arcs are; semi-circular, one-centered depressed, two-centered depressed and two-centered pointed. The profiles based on the volumetric formations are; segmented, segmented semi-circular, flattened or depressed and pointed pyramidal domes.

For the profile terminology of the domes; rather than the categorizations mostly come through analogy such as pyramid, hemisphere, and flattened spheres, the categorizations based on geometric orders are preferred in the dissertation.

In the terminology used for the names of spatial components, the place names of the Ottoman Turkish baths continued to be used in Turkish. The names of spatial components are: *soyunmalık* (disrobing area), *ılıkık* (warm part), *sıcaklık* (hot bathing area) and *halvets* (private hot cells). However, the fact that place names are Turkish words in the italic font used in the thesis. Additionally, italic font is utilized for all words belonging to the other languages that are the original non-English.

## **CHAPTER 2**

### **DEFINITIONS**

#### **2.1. Dome**

Dome can be defined as the arc or arcs with turning circle around perpendicular line coming from the top of vertical cross-section of the arch (Hasol 1998). Therefore, domes are defined with circle arc or arcs in a similarity of arches, such as semi-circle, two-centered pointed, etc. Additionally, domes have run as a shell, thus they can be identified in the shell masonry systems.

Dome can also be identified as superstructure formed similarity with the shape of spherical cap, hemispherical or curved spherical top. Domes were utilized as superstructure for covering of square, polygonal or circular plans. From the polygonal to the circular base of domes, pendentives and squinches were utilized as the transition elements to the domes (Hasol 1998).

Domes usually provide a covering for a square- or polygonal- planned space or spatial components. Thus, there are the transition adjustments from the square to the circular, elliptical, or polygonal base of the dome (Curl and Sambrook 1999). This can be achieved by means of pendentives, squinches, plain triangles or Turkish triangles.

##### **2.1.1. Historical Background of Domes**

Masonry domes made of traditional construction techniques and construction materials have been effectively and widely utilized to cover the spatial components with long span and large volumes by thin shell without supporting elements in the middle in historic buildings since the Roman period (Fahjan 2006; Altın 2001; Kolay 1999).

In the Roman, Byzantine and Anatolian Seljuk architecture, domes were utilized with vaults for the superstructure, whereas from the Principalities period domes were being used as the primary superstructure element and in Ottoman period become widely prevalent (Kolay 1999). In the period of the 14<sup>th</sup> and the 15<sup>th</sup> centuries, dome were



widely used as a superstructure of mid-span spatial components or as a sequence composed of several juxtaposed domes to each other with short spans and the same dimensions. In the 16<sup>th</sup> century in Ottoman architecture, the domes were used in sophisticated geometrical orders and the construction techniques were improved, thus a great number of domes were built (Fahjan 2006).

In addition, domes were used as the superstructure for emphasizing special volumes or spatial components in Anatolian Seljuks, Principalities, and Ottoman architectures. These are mainly; as superstructure in the mosques the emphasizing of mihrab niche axis, in the tombs composed of single spatial component, in the caravansaries for the purpose of lighting of the middle axis, in the *medreses* the main-rooms and in some of enclosed *medreses* as superstructure of forecourt (Yavuz 1983; Kolay 1999). Additionally, in the baths domes are determined that they were utilized as the superstructure of all square and polygonal spatial components.

As construction materials in the dome bonds, the utilization of bricks were growing in Roman period, being used as main construction materials in Byzantine period and then in Ottoman period the almost all superstructure were built with bricks (Kolay 1999).

#### **2.1.1.1. Domes in the Roman and Byzantine Architecture**

Domes, which were constructed with bricks and lime mortar as binder, were invented in Mesopotamia and were developed later on in Roman period (Figure 2.1). Domes were built by pouring concrete onto the framework, sometimes the upper part of the domes was lightened by placing amphorae (anfora) inside by way of centering. However, in the construction of brick domes the stability was ensured without centering by building ring by ring horizontally. The most important innovation in the Byzantine period was the superimposition of a dome over a square by connecting elements (pendentives) between the dome and the base. The Byzantine dome is characterized by a high cylindrical shell in an octagon shape (Figure 2.2). Masonry consists of shallow solid bricks (4-5 cm in thickness) and crushed-tile lime mortar forming joints of the same size thickness as the bricks in the Byzantine domes (Acland 1972).

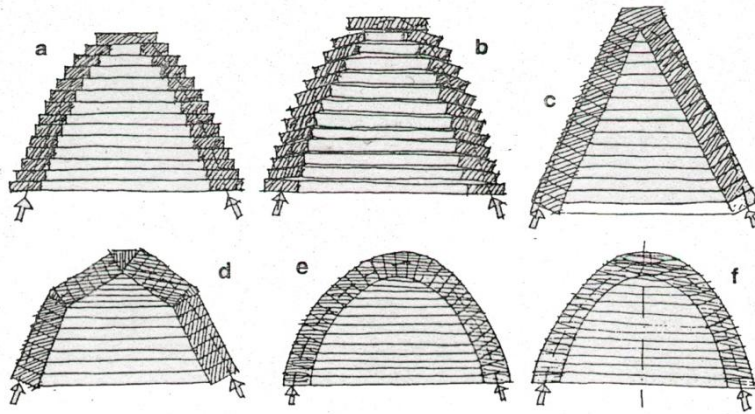

Figure 2.1. Different types of domes, developing forms of the domes from ancient time to the present (Source: Escrig 1995).

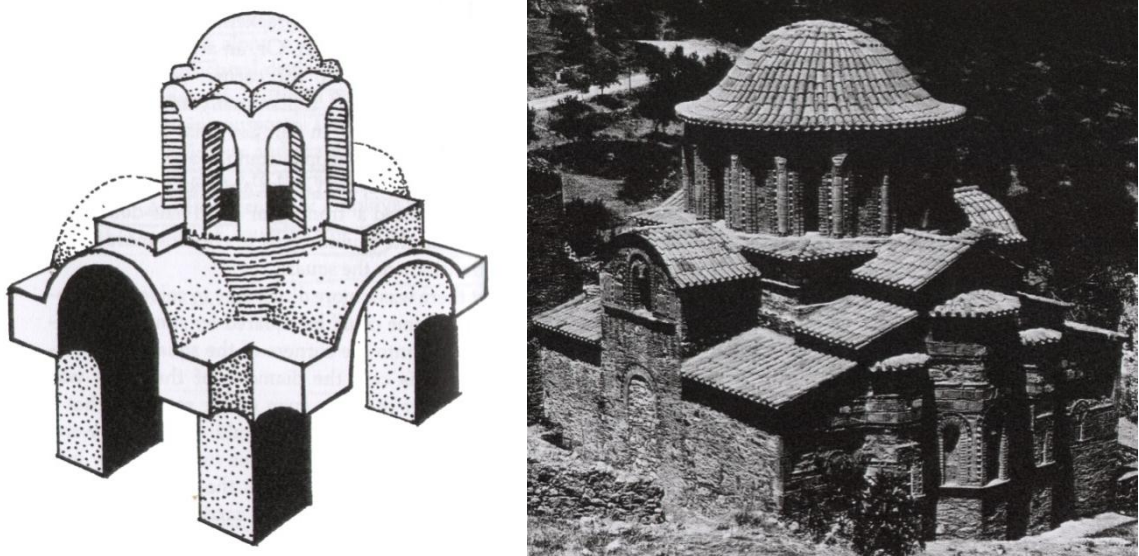

Figure 2.2. The Byzantine dome with a high cylindrical shell in an octagon shape (Source: Acland 1972).

### 2.1.1.2. Domes in the Anatolian Seljuks and Principalities Architecture

In Seljukian architecture the dome, with the similarity of Ottoman architecture, was not a common superstructure for mostly all spatial components; it was only a superstructure element emphasizing special spatial components and units.

In Anatolian Seljuk buildings, domes were usually used in semi-circle profiles and they were started from within wall or a low drum. Domes of this period have got a

plain bond system by contrast with use of glazed bricks seen in Iran Architecture or stacking of bricks in various compositions. Therefore, the dome has been used as external and pyramidal or conic forms with a high drum, and internal on double-layers construction which were seen generally in the tromp domes in Iran and Anatolia (Kolay 1999).

In the period of Principalities, domes were utilized as plain and in hemispherical geometrical forms regarding structural causation in the short-span spaces as single superstructural element and in the great mosques as a superstructure of the mihrab-front. In the baths domes were utilized as superstructure of all main spatial components (Kolay 1999).

Domes were settled in two cases; either on the flesh walls or on the drum that was located between flesh wall and dome. In case of increasing the springing level of the dome exterior from the height of lay off the flesh walls, domes were settled directly on the flesh walls. In general, there is a frame as narrow slide between dome base and transition zones, which has a beam function, and the springing level of domes were started from that level of frame named impost line.

In the constructions of Principalities period, the use of drum between flesh walls and dome base was a widespread application. In single-drum use, impost line of the dome and drum generally rose from the same level in height. In general, drums were used in octagonal form and as exterior supporting element which enforced the dome structurally. In rare cases, domes were rised from the drum. The third use type was with the double drums. In this alternative, the beginning (impost line) of the dome is at the level where two drums are combined. The drum below is the slide on which the dome side lies, and the drum above is an element enforcing and supporting the dome. The drum above repeats the polygon and plan of the drum below. Domes were generally utilized without ornaments in plain form. The ornaments generally hold on the drum in the exterior and interior side. At the springing level of domes in some cases muqarnas sequences were used as ornament interior, whereas saw threads were used in one or two rows at the end of drum exterior (Kolay 1999).

### 2.1.1.3. Domes in the Ottoman Architecture

Dome is central feature in Ottoman architecture. In early examples, the dome was like a lid on thick flesh walls; later, pier and buttress brought about new conception of architectural structure, and space was found for opening arrangements between the dome and the wall below.

The Ottoman dome, so as the dome in the architecture of the Seljuks, is superstructure of special spaces and particular units. The use proportion of dome on the superstructure was low on account of using the superstructure of vault generally. They were the natural superstructure of single units such as mosque, trompt, masjid in the Ottoman period.

Domes were mostly determined the superstructure of bath building type numerically. The domed spaces are generally *soyunmalık* (disrobing areas), *sıcaklık* (hot bathing spaces) and also *halvets* (private rooms) are widespread. The use of dome in madrasas and khan was on the entrance axis in the middle of superior barrel vault as like lighting cupola.

The profiles of domes were various, such as semi-dome profiles, two centered pointed and depressed profiles. In rare cases, it can be seen segmented and pyramidal-shaped profiles.

## 2.2. Profiles

The form that has been drawn by the arc in the vertical cross-section passing through the center of the domes is the profiles similar to arches. The basic elements determining the profiles is the union formed by the arcs which are drawn at the centers of the dome and whose number of centers is equal to these arcs. As a result of the relation between the features such as the span, height (impost line), and the radius of the arc (central line), the profiles display variations.

The elements forming the dome have been shown in Figure 2.3. At the drawing in Figure 2.3, the springing and top levels of the semi-circular-profiled dome have the same thickness. The terminology used for the elements of the dome has been marked on the drawing.

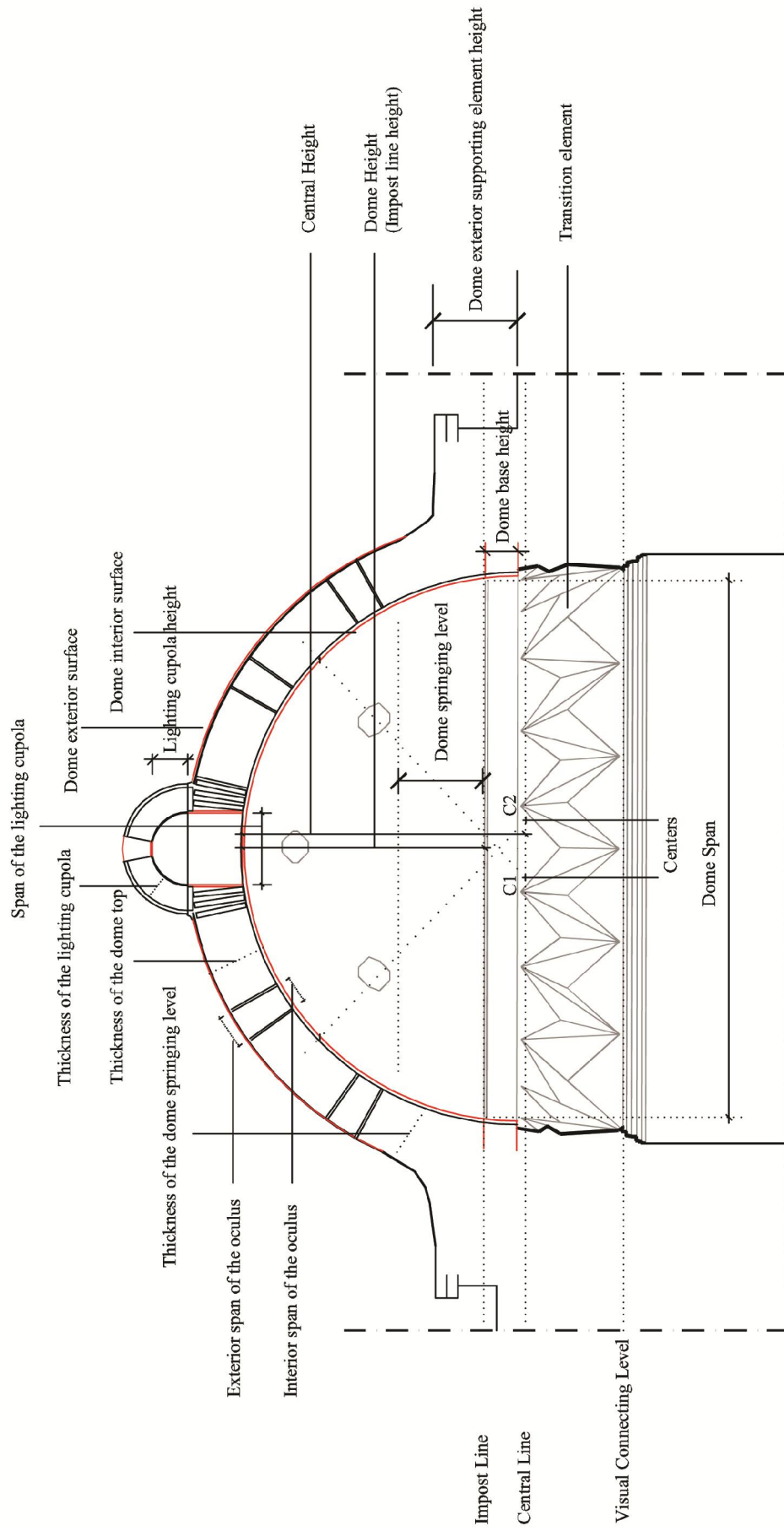

Figure 2.3. The elements forming the dome.

It has been determined that there are six different variations for the dome profiles. These are semi-circular, one-centered depressed, two-centered depressed, two-centered pointed, truncated-pyramidal and segmented profiles. Of these, the semi-circulars, one-centered depressed, two-centered depressed and two-centered pointed profiles are related to geometric descriptions while the pyramidal and segmented profiles are related to volumetric ones. The profiles shaped by the relation of the span and height have been determined in sixty-six domes out of seventy-nine. The rest unspecified thirteen domes have collapsed today due to man-made (vandalism) interference or natural factors.

In the Ottoman-period domes, the two-centered pointed profiles have been widely used rather than the one-centered profiles (depressed, semi-circular) (Yavuz 1983). However, when the domes of the baths are examined, it is seen that the semi-circular profile has been used in thirty-four of sixty-six domes (Figure 2.4).

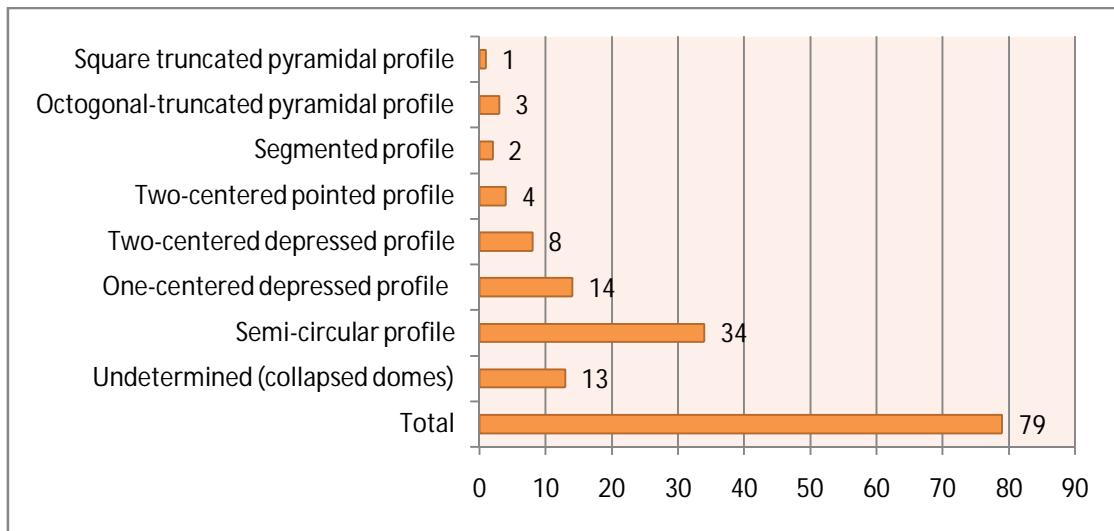

Figure 2.4. The distribution of baths according to the profiles.

When investigating the numerical distribution of the dome profiles, it has been seen that of the total determined sixty-six domes, thirty-four of them have semi-circular, twenty-two of them have depressed, four of them have two-centered pointed, four of them have truncated-pyramidal and two of them have segmented profiles. Among the twenty-two depressed profiles, fourteen of them are one-centered and eight of them are

two-centered. The truncated-pyramidal profiles have been used in the men's section, in the sub-unit of *ılıklik* (shaving space) and in the square-planed north iwan of Tire Tahtakale Hamamı and in the *sıcaklık* main space of the women's section of Urla Hersekzade Ahmet Paşa Hamamı. On the other hand, segmented profiles have been used in the semi-domes of the side unit iwans of the *sıcaklık* main space in Tire Tahtakale Hamamı men's section and in the *ılıklik* and *halvet* of the men's section in Tire Hekim Hamamı. In the truncated-pyramidal profiles, the dome of *aralık* space has a square profile whereas the rest have octagonal truncated-pyramidal profiles.

Fourty of the profiles were used in short-span domes, nineteen were used in mid-span domes and seven were used in long-span domes. The semi-circular profiles used in thirty-four of sixty-six domes show variations according to the span. They have been used as nineteen of forty in short-span domes, ten of nineteen in mid-span domes and five of seven in long-span domes. For this reason, it has been claimed that most common dome profile is the semi-circular profile in the examined domes. The next common is the depressed profile. Among the sixty-six domes, twenty-two of them have depressed profiles. They have been used as fifteen of forty in short-span domes, five of nineteen in mid-span domes and two of seven in long-span domes. The twenty-two depressed profiles is  $\frac{1}{3}$  (one to third) of the total sixty-six domes. The fourteen of fifteen short-span domes have one-centered and the last one has two-centered depressed profile. In the five mid-span domes and two long-span domes, the two-centered depressed profiles have been used. According to this statement, all of the fourteen one-centered-depressed profile domes are short-span while five of eight two-centered-depressed profile domes are mid-span, two of them are long-span and one is short-span. The less used profiles are respectively, two-centered-pointed, truncated-pyramidal and segmented domes. Two of the four two-centered-pointed profile domes are short-span and the rest are mid-span. It has been determined that of the truncated-pyramidal domes, three are short-span and one is mid-span whereas of the two segmented domes, one is short-span and the other is mid-span (Table 2.1).

Table 2.1. The distribution of profiles according to the dome spans.

Dome Profiles	Domes			
	Short-span	Mid-span	Long-span	Total
Semi-circular profile	19	10	5	34
One-centered-depressed profile	14	0	0	14
Two-centered-depressed profile	1	5	2	8
Two-centered-pointed profile	2	2	0	4
Segmented profile	1	1	0	2
Octogonal-truncated-pyramidal profile	2	1	0	3
Square truncated-pyramidal profile	1	0	0	1
Undetermined (collapsed domes)	5	8	0	13
Total	45	27	7	79

According to the number of centers, forty-eight of sixty-six domes are one-centered, twelve of them are two-centered and six of them have different volumetric properties. Of these six domes with respect to the volumetric properties, four are truncated-pyramidal domes and two are segmented domes.

The impost line, which is the starting line of the arc, determines the height of the dome, so the profile. According to the span-height ratio of the dome, the profile either rises or becomes depressed. In case the central and impost lines are the same, the height of the domes equals the radius of the dome. This means that the dome has semi-circular profile. The span-height ratio is equal to  $\frac{1}{2}$  in the semi-circular profiles, more than  $\frac{1}{2}$  in the pointed profiles and less than  $\frac{1}{2}$  in the depressed ones. In case the central line is underneath the impost line, the span-height ratio is less than  $\frac{1}{2}$ , and this determines the degree of oblateness of the dome profile.

The impost line determines the height of the dome while the central line determines the radius of the arc. Further, the relationship between the impost and central lines defines the degree of oblateness. The relationship is pointed out that as long as the level difference between the impost and central lines increases, the arcs that define the dome profile become depressed, the span between the centers and the degree of oblateness increases.

It has been determined that the span-height ratio, in other words the degree of oblateness, has a value between 0.40 and 0.48 in the examined domes (see in the section 3.2.2). The span-height ratio in Mimar Sinan's mosque domes, which were built in the



same period and have a span between 12 and 14.5 meters, is between 0.30 and 0.38,5 (Çamlıbel 1998).

As it is seen in Figure 2.5, there is a linear correlation between the height and the degree of oblateness. However, it can be claimed that the formula of the dome oblateness designated by Cowan (1977) initially, is not enough to define the oblateness. According to dome definition of profile oblateness, when height increases, the degree of oblateness decreases and when the height decreases, the degree of oblateness increases. The dome segment from the center of the dome circle to the dome with a central angle of  $103^\circ$  is in compression while the rest is in tension (Cowan 1977; Mark 1993; Çamlıbel 1998; Günay 2006; Mungan 2009).

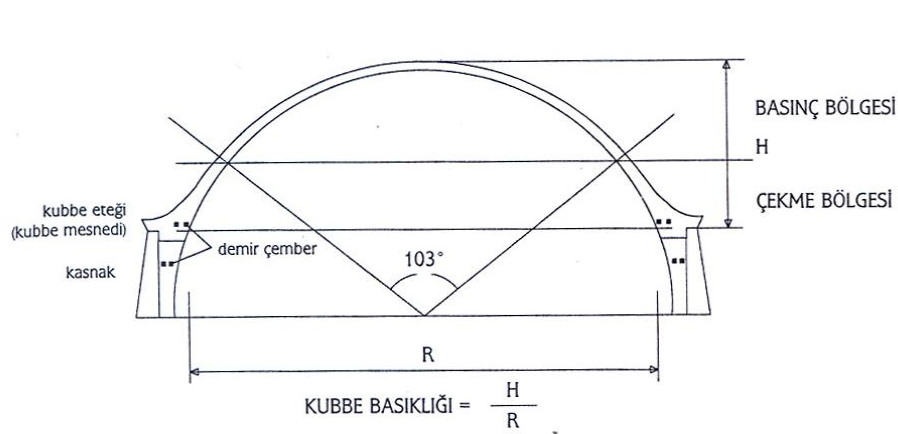

Figure 2.5. The dome oblateness  
(Source: Günay 2006).

It has been stated that the dome segment in the tension zone is either thicker than the dome segment in the compression zone due to the potential cracks and deformations against tensional forces or it has been reinforced with external support elements to increase the sectional thickness in this zone. This statement can be seen in Fontana's book (1694) in which he has proposed that the springing level of the dome need to be reinforced with external support elements. It can be said that his proposal has been applied in those times of Ottoman dome architecture and it has constituted a part of traditional architecture.

Çamlıbel (1998) stated that two conditions are demanded to provide resistance in the masonry structures. The first of them is the necessity that, by the effects of the loads,

the maximum compressive stresses on the load-bearing elements cannot exceed the admissible stress of the material; and the second one is that the tensile stresses in the load-bearing elements cannot reach the level that causes cracks. It is stated that achieving these conditions is also related with the geometry of the load-bearing element. The ratio of dome oblateness varies between 0.30-0.38,8 in the domes examined by Çamlıbel.

In all studied bath domes, the ratio between the projection distance on the horizontal plane and the span of the dome segment, which is in between the central angle of  $103^\circ$  and being exposed to compression, is 4:5 (four to fifth). Furthermore, for the dome segment exposed to tensional forces in the tension zone, this ratio is approximately 1:5 (one to fifth), in other word, it is 20% - 21% of the span (Figure 2.6).

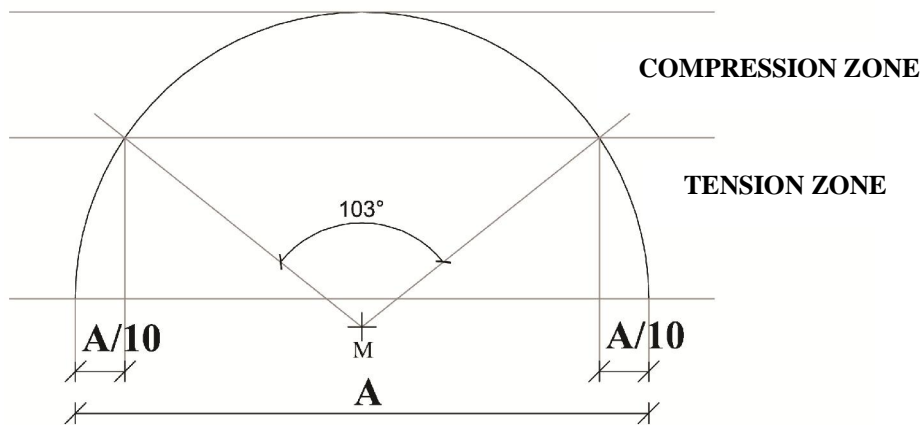

Figure 2.6. The ratio of compression and tension parts of the dome to dome span.

### 2.2.1. Semi-circular Profiles in the Examined Domes

In semi-circular profiles, the impost and central lines are the same and the height is equal to half of the span. The central and impost height and the radius of the profile arc have the same dimensions with half of the span (Figure 2.7). The semi-circular profiles, the profiles depressed slightly than semi-circular profiles may be evaluated within the same category for the reason of approximate dimensions of the domes (Figure 2.8).

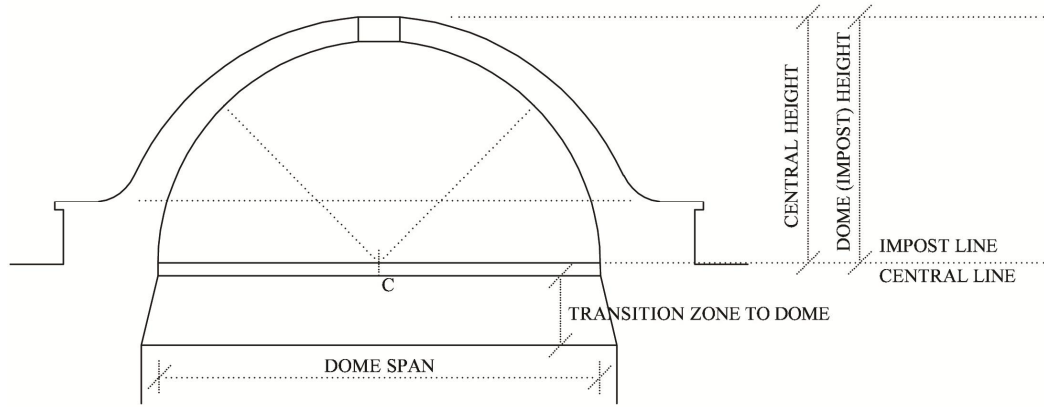

Figure 2.7. Semi-circular profiles.



Figure 2.8. Tire Tahtakale Hamamı men's section *sıcaklık* main space dome in semi-circular profile.

In the examined domes due to the difference between the central and impost lines being approximately 5%, less than 10%, of the span of the dome it can be pointed out that the reason for putting the profiles depressed slightly than semi-circular into the semi-circular profiles. Moreover, it can be emphasized that they should be considered as depressed profiles in case the difference is equal or more than 15% approximately. In rather depressed profiles, the difference between the central and impost lines is determined between 1.5 and 47.5 centimeters. The range of domes in baths with respect to the semi-circular, depressed slightly than semi-circular profiles can be seen in Table 2.2.

Table 2.2. The domes which have semi-circular profiles and depressed slightly than semi-circular profiles.

<b>Baths</b>	<b>Space</b>	<b>Height(m)</b>	<b>Span(m)</b>	<b>Transition element</b>
Seferihisar Büyük H.	<i>ılıklik</i> sub-unit	0.60	1.35	Squinch
Seferihisar Büyük H.	<i>ılıklik</i> main unit	0.80	1.75	Pendentive
Seferihisar Küçük H.	halvet	0.90	1.90	Pendentive
Tire Yeniceköy H.	<i>ılıklik</i> sub-unit	0.94	2.20	Turkish triangles
Sığacık Kaleiçi H.	<i>sıcaklık</i> main space	0.95	2.20	Pendentive
Urla Hersekzade Ahmet Paşa H.(W)	<i>ılıklik</i> main unit	0.75	2.25	Pendentive
Urla Özbek Köyü H.	<i>sıcaklık</i> main space	1.00	2.40	Pendentive
Ulamış H.	<i>sıcaklık</i> main space	1.26	2.71	Pendentive
Ulamış H.	halvet	1.30	2.87	Pendentive
Seferihisar Küçük H.	<i>sıcaklık</i> main space	1.50	2.90	Plain triangle
Düzce (Hereke) H.	halvet	1.40	2.90	Two segmented plain triangle
Tire Mehmet Ağa H.(W) [1]	<i>sıcaklık</i> main space	1.25	2.90	Pendentive
Tire Mehmet Ağa H.(W)	halvet	1.22	2.90	Pendentive
Seferihisar Büyük H.	halvet	1.20	2.95	Pendentive
Urla Hersekzade Ahmet Paşa H.(M)	<i>ılıklik</i> main unit	1.60	3.00	Pendentive
Urla Hersekzade Ahmet Paşa H.(M)	halvet	1.50	3.00	Pendentive
Tire Mehmet Ağa H.(W) [2]	<i>sıcaklık</i> main space	1.28	3.00	Pendentive
Tire Hekim H.(M)	<i>sıcaklık</i> main space	1.51	3.05	Two segmented plain triangle
Tire Tahtakale H.	<i>sıcaklık</i> main space	1.49	3.40	Turkish triangles
<b>Düzce (Hereke) H.</b>	<b><i>sıcaklık</i> main space</b>	<b>1.76</b>	<b>3.50</b>	<b>Pendentive</b>
<b>Tire Yeniceköy H.</b>	<b>halvet</b>	<b>1.57</b>	<b>3.50</b>	<b>Turkish triangles</b>
<b>Urla Hersekzade Ahmet Paşa H.(W)</b>	<b>halvet</b>	<b>1.65</b>	<b>3.52</b>	<b>Pendentive</b>
<b>Urla Hersekzade Ahmet Paşa H.(W)</b>	<b>halvet</b>	<b>1.64</b>	<b>3.56</b>	<b>Pendentive</b>
<b>Tire Tahtakale H.</b>	<b>halvet</b>	<b>1.51</b>	<b>3.60</b>	<b>Turkish triangles</b>
<b>Tire Tahtakale H.</b>	<b>halvet</b>	<b>1.51</b>	<b>3.60</b>	<b>Turkish triangles</b>
<b>Tire Mehmet Ağa H.(M)</b>	<b>halvet</b>	<b>1.91</b>	<b>3.70</b>	<b>Squinch</b>
<b>Seferihisar Küçük H.</b>	<b>halvet</b>	<b>1.80</b>	<b>3.79</b>	<b>Pendentive</b>
<b>Tire Mehmet Ağa H.(M)</b>	<b><i>sıcaklık</i> main space</b>	<b>1.64</b>	<b>3.85</b>	<b>Pendentive</b>
<b>Tire Tahtakale H.</b>	<b><i>ılıklik</i> main unit</b>	<b>1.77</b>	<b>4.08</b>	<b>Turkish triangles</b>
<b>Düzce (Hereke) H.</b>	<b><i>soyunmalık</i></b>	<b>3.15</b>	<b>7.25</b>	<b>Plain triangled squinch</b>

(cont. on next page)

Table 2.2. (cont.)

<i>Seferihisar Büyük H.</i>	<i>soyunmalık</i>	<i>3.20</i>	<i>7.40</i>	<i>Segmented squinch</i>
<i>Tire Yalınayak H.(W)</i>	<i>soyunmalık</i>	<i>3.20</i>	<i>7.80</i>	<i>Squinch</i>
<i>Tire Yalınayak H.(M)</i>	<i>soyunmalık</i>	<i>3.57</i>	<i>8.20</i>	<i>Pendentive</i>
<i>Tire Eski-Yeni H.(M)</i>	<i>soyunmalık</i>	<i>5.10</i>	<i>10.25</i>	<i>Pendentive</i>

Short-span domes

**Mid-span domes***Long-span domes*

It has been determined that thirty-four of total sixty-six domes have semi-circular profiles (Figure 2.9). Of these, nineteen of them are short-span, ten of them are mid-span and five of them are long-span domes. Among the semi-circular short-span domes, in thirteen of them pendentives have been used as the transition element to the dome, three of them used one and two segmented plain triangles, two of them used Turkish triangles and the last used squinch. Of the ten mid-span domes, the transition element to the dome is pendentive in five, Turkish triangles in four and squinch in one while of the five long-span domes, it is squinch in three and pendentive in two. Accordingly, the pendentive has been used as the transition element to the dome in twenty of thirty-four domes whose profile is semi-circular. Additionally, the use of Turkish triangles and squinches approximately is the same while plain triangles are less (Table 2.3).

Table 2.3. The distribution of transition elements according to dome spans in semi-circular profiles.

<b>Semi-circular profiles</b>					
	<b>Pendentive</b>	<b>Turkish triangles</b>	<b>Squinch</b>	<b>Plain triangle</b>	<b>Total</b>
<b>Short-span</b>	13	2	1	3	19
<b>Mid-span</b>	5	4	1	0	10
<b>Long-span</b>	2	0	3	0	5
<b>Total</b>	20	6	5	3	34



Figure 2.9. Tire Yalınayak Hamamı men's section *soyunmalık* domes in semi-circular profile.

### 2.2.2. Depressed Profiles: One-centered and Two-centered

In depressed profiles, the height of the central line is below the impost line. The radius of the arc is more than half of the dome span. Oblateness is determined approximately between 5% and 10% percentage of the span in the semi-circular profiles. On the contrary, this ratio is determined approximately 15% and more in depressed profiles. The one-centered (Figure 2.10) and two-centered (Figure 2.11) depressed profiles can be evaluated in the same group.

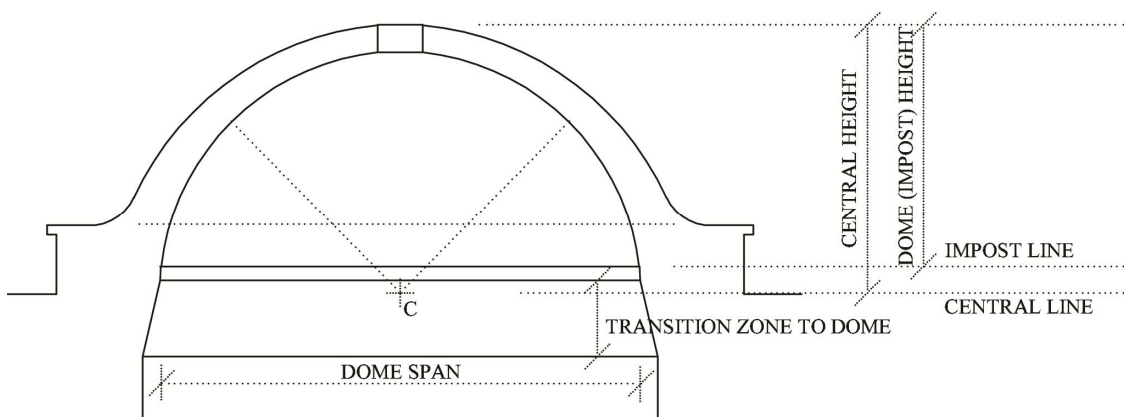

Figure 2.10. One-centered depressed profiles.

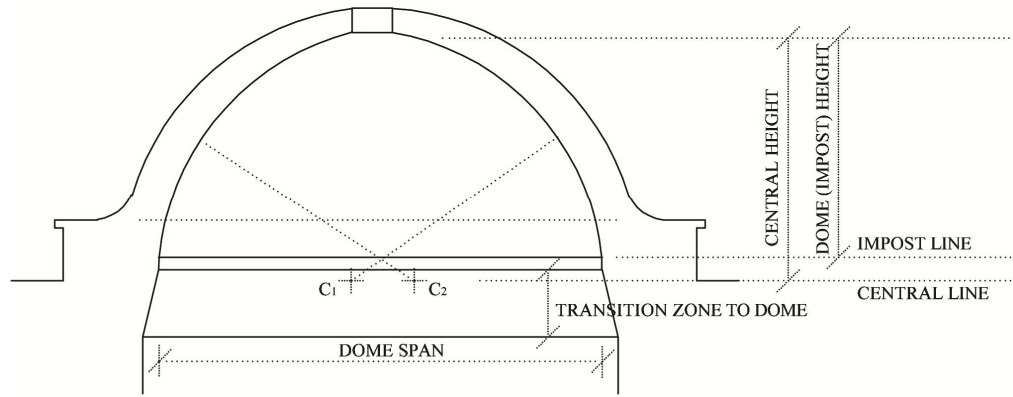

Figure 2.11. Two-centered depressed profiles.

It has been determined that the one-centered depressed profiles have been used in fourteen short-span domes whose opening is up to three meters while the two-centered depressed profiles have been used in total six domes, respectively one short-span dome whose opening is more than three meters, five mid-span and two long-span domes (Table 2.4). However, the distance between the centers is less than 15% of the span in two-centered depressed profiles.

Table 2.4. The distribution of depressed profiles according to dome spans and the number of dome centers.

<b>Depressed profiles</b>			
	<b>One-centered</b>	<b>Two-centered</b>	<b>Total</b>
<b>Short-span</b>	14	1	<b>15</b>
<b>Mid-span</b>	0	5	<b>5</b>
<b>Long-span</b>	0	2	<b>2</b>
<b>Total</b>	<b>14</b>	<b>8</b>	<b>22</b>

The transition to the dome is provided with pendentive in the short-span depressed profiles whereas it shows different variations in mid and long-span domes. The domes with depressed profiles can be seen in Table 2.5.

Table 2.5. The use of depressed profiles in domes.

<b>Baths</b>	<b>Space</b>	<b>Height(m)</b>	<b>Span(m)</b>	<b>Transition element</b>
Sığacık Kaleiçi H.	<i>Halvet</i>	0.65	2.16	Pendentive
Sığacık Kaleiçi H.	<i>Halvet</i>	0.70	2.23	Pendentive
Urla Hersekzade Ahmet Paşa H.(W)	<i>İlklık</i> sub unit	1.01	2.25	Pendentive
Urla Özbek Köyü H.	<i>Halvet</i>	0.87	2.25	Pendentive
Urla Özbek Köyü H.	<i>Halvet</i>	0.87	2.28	Pendentive
Tire Yalınayak H.(M)	<i>Halvet</i>	0.58	2.50	Saw-toothed Pendentive
Tire Yalınayak H.(M)	<i>Halvet</i>	0.98	2.50	Saw-toothed squinch
Tire Yalınayak H.(W)	<i>Halvet</i>	0.76	2.55	Squinch & Saw-toothed Pendentive
Tire Hekim H.(W)	<i>İlklık</i> sub unit	0.91	2.75	Plain triangle
Tire Hekim H.(W)	<i>İlklık</i> main unit	1.10	2.76	Pendentive
Ulaş H.	<i>Halvet</i>	1.10	2.78	Pendentive
Seferihisar Büyük H.	<i>Sıcaklık</i> main space	1.10	2.95	Pendentive
Seferihisar Büyük H.	<i>Halvet</i>	1.15	2.95	Pendentive
Tire Şeyh H.	<i>Sıcaklık</i> main space	1.18	3.00	Pendentive
<b>Urla Kamanlı H.</b>	<i>Halvet</i>	<b>1.17</b>	<b>3.03</b>	<b>Squinch</b>
<b>Tire Yeniceköy H.</b>	<i>Halvet</i>	<b>1.35</b>	<b>3.50</b>	<b>Pendentive</b>
<b>Urla Kamanlı H.</b>	<i>Sıcaklık</i> ana mekan	<b>1.10</b>	<b>3.56</b>	<b>Pendentive with Muqarnasses</b>
<b>Tire Hekim H.(W)</b>	<i>Sıcaklık</i> main space	<b>1.44</b>	<b>3.70</b>	<b>Two segmented plain triangle</b>
<b>Tire Yeniceköy H.</b>	<i>Sıcaklık</i> main space	<b>1.46</b>	<b>3.70</b>	<b>Plain triangle</b>
<b>Tire Yalınayak H.(M)</b>	<i>Halvet</i>	<b>1.46</b>	<b>4.35</b>	<b>Plain triangle &amp; squinch</b>
<b>Tire Yalınayak H.(M)</b>	<i>Sıcaklık</i> main space	<b>2.56</b>	<b>7.80</b>	<b>Saw-toothed Pendentive</b>
<b>Tire Tahtakale H.</b>	<i>Soyunmalık</i>	<b>4.93</b>	<b>12.65</b>	<b>Turkish triangles</b>

Short-span domes / one-centered depressed profiles

**Short, mid and long-span domes / two-centered depressed profiles**

The transition element to the dome of the depressed profile domes with respect to the span is seen in Table 2.6. Eleven of the fifteen short-span domes used pendentive, two used squinch, one used plain triangle and the other used pendentive and squinch



combined together. Two of the five mid-span domes used pendentive, two used plain triangle and one used squinch and plain triangle combined together while one of the two long-span domes used pendentive and the other used Turkish triangles. Accordingly, fourteen of the total twenty-two domes used pendentive, three of used squinch, one of used Turkish triangles and the last used pendentive and plain triangle combined together for the transition element to the dome.

Table 2.6. The distribution of transition elements according to dome spans in depressed profiles

<b>Depressed profiles</b>					
	<b>Pendentive</b>	<b>Turkish triangles</b>	<b>Squinch</b>	<b>Plain triangle</b>	<b>Total</b>
<b>Short-span</b>	<b>11.5</b>	0	<b>2.5</b>	<b>1</b>	<b>15</b>
<b>Mid-span</b>	<b>2</b>	0	<b>0.5</b>	<b>2.5</b>	<b>5</b>
<b>Long-span</b>	<b>1</b>	<b>1</b>	0	0	<b>2</b>
<b>Total</b>	<b>14.5</b>	<b>1</b>	<b>3</b>	<b>3.5</b>	<b>22</b>

### **2.2.3. Two-centered Pointed Profiles in the Examined Domes**

In two-centered pointed profiles, the height of the central line is above the impost line and dome height is more than half of the dome span. Differences between central height and dome height (impost height) define the value of being pointed. Profile is pointed geometrical shape that is defined by circle two arcs that identify the central line. The main elements defined the geometrical form are; the centers of arcs, distance between two centers, distance between central line and impost line, and the ratio of dome height to dome span. In general, the centers are on the central lines at the same level to each other (Figure 2.12).

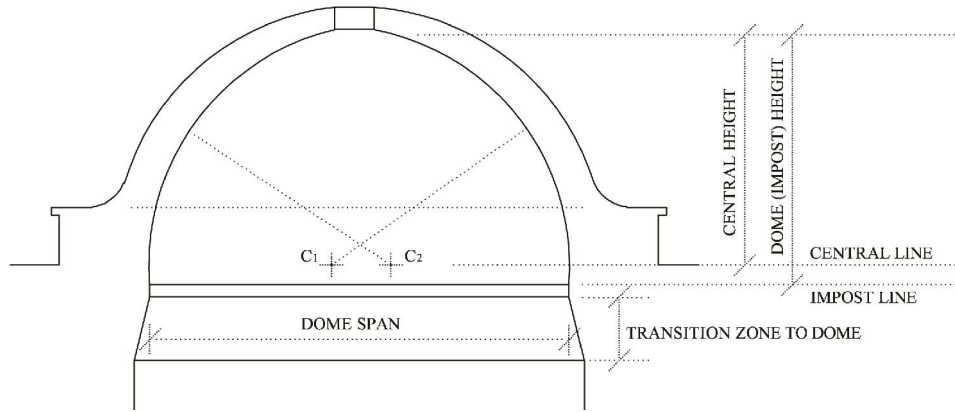

Figure 2.12. Two-centered pointed profiles in the examined domes.

It has been determined that the two-centered pointed profiles have been only used in four domes; two of short-span domes and two of mid-span domes. Two of which are *halvet* domes of Urla Kamanlı Hamamı, one is Tire Mehmet Ağa Hamamı men's section *halvet* dome, and the other is Urla Rüstem Paşa Hamamı *sıcaklık* main space dome (Table 2.7).

Table 2.7. The use of two-centered pointed profiles in domes.

Baths	Space	Height(m)	Span(m)	Transition element
Urla Kamanlı H.	<i>Halvet</i>	1.50	2.17	Pendentive
Urla Kamanlı H.	<i>Halvet</i>	2.01	2.87	Turkish triangles
<b>Tire Mehmet Ağa H.(M)</b>	<i>Halvet</i>	<b>2.81</b>	<b>3.70</b>	<b>Squinch</b>
<b>Urla Rüstem Paşa H.</b>	<b><i>Sıcaklık</i> main space</b>	<b>3.51</b>	<b>5.30</b>	<b>Pendentive</b>

Short-span domes

Mid-span domes

In these domes with two-centered pointed profiles, the difference between dome height and the radius of central arcs are changing between 47 and 96 centimeters. These differences are determined with the range of 20% and 21.6% for the two short-span domes, whereas with the range of 16% and 26% for the mid-span two domes. The mid-span *halvet* dome of Tire Mehmet Ağa Hamamı men's section has the highest

difference while the mid-span *sıcaklık* main space of Urla Rüstem Paşa Hamamı is the lowest one. In the *halvet* and *sıcaklık* main space domes whose profiles are two-centered pointed the transition elements are for two pendentives, one is squinch and the other is Turkish triangles. For each dome due to the transition element has different variety from each other, the relationship between the types of transition elements to the dome and profiles could not be determined (Table 2.8).

Table 2.8. The distribution of two-centered pointed profiles according to dome spans.

<b>Two-centered Pointed Profiles</b>					
	<b>Pendentive</b>	<b>Turkish triangles</b>	<b>Squinch</b>	<b>Plain triangle</b>	<b>Total</b>
<b>Short-span</b>	<b>1</b>	<b>1</b>	<b>0</b>	<b>0</b>	<b>2</b>
<b>Mid-span</b>	<b>1</b>	<b>0</b>	<b>1</b>	<b>0</b>	<b>2</b>
<b>Long-span</b>	<b>0</b>	<b>0</b>	<b>0</b>	<b>0</b>	<b>0</b>
<b>Total</b>	<b>2</b>	<b>1</b>	<b>1</b>	<b>0</b>	<b>4</b>

## **2.2.4. Segmented Profiles in the Examined Domes**

Segmented profiles are dealt with as volumetric formations. They can be classified in two types; horizontal segmented profiles and vertical segmented profiles according to the segmenting either at the horizontal plane or at the vertical plane. Therefore, each type has improved different volumetric characteristics. In the segmented domes, there were formed ribbed surfaces being the result of segmenting surface in horizontal and vertical directions, and lighting elements such as oculi were placed within the formed slices.

### **2.2.4.1. Segmented Profiles in the Horizontal Direction**

In the horizontal plane slices were created by means of brick bond of the dome in the form of a horizontal arrangement of the ribs. By stacking in slice thickness of the dome half bricks while in dome thickness whole bricks created segmented dome and within the slice can be seen a marked thinning. Consequently, the loads from the top to

the sub-structures transfer through the ribs in between the slices. The segmented profiles in the horizontal direction can be seen in the superstructure of southwest *halvet* of Tire Hekim Hamamı men's section as the unique instance (Figure 2.13). In this case, in the horizontal plane sixteen slices were placed in the elliptical geometric form and in the circular belt at the springing level interior. There was arranged an oculus made of terracotta pipe in the bond within each slice of the dome.

The curvature of the dome was continued upper side of the slices till the top in plain surfaces and there were placed three circular rows oculi made of terracotta pipes in the bond in the upper part of the dome. The brick bond and profiles ended with lighting cupola on the top.



Figure 2.13. Segmented profiles in the horizontal direction located in the *halvet* dome of Tire Hekim Hamamı men's section.

#### **2.2.4.2. Segmented Profiles in the Vertical Direction**

In the vertical direction slices were created by means of brick bond of the dome in the form of a vertical arrangement of the ribs from the springing level to dome top in the vertical segmented profiles. The bond was arranged by means of stacking the whole and half bricks together in order to create vertical curved slices. In which the ribs placed the thickness were formed by use of double-brick rows, in the slice either one whole brick or half bricks stacking from the springing level to the top and placed oculi made of terracotta pipes in the bond. The dome composed of fourteen slices. Unlike the other

profiles, lighting elements were placed aligned along the vertical slices and to form a circular sequence in horizontal plane used in two circular rows. The segmented profiles in the vertical direction can be seen in the superstructure of *ılıklik* space of Tire Hekim Hamamı men's section as the unique instance (Figure 2.14). The lighting was ensured by means of the arrangements of lighting cupola on the top and oculi in two circular rows; with fourteen oculus placed for each row, as used two oculus within the slices for each one, made of terracotta material in the brick bond. The slices, starting at the springing level of the dome going up to the top and ending with lighting cupola, shows continuity.



Figure 2.14. Segmented profiles in the vertical direction located in the *ılıklik* dome of Tire Hekim Hamamı men's section.

### 2.2.5. Segmented Semi-circular Profiles

In the vertical direction slices of segmented semi-circular profiles were created by means of brick bond of the semi-dome in the form of a vertical arrangement of the ribs from the springing level till the top (Figure 2.15). These profiles can be only seen in the superstructure of iwan side unit of Tire Tahtakale Hamamı men's section *sıcaklık* main space. Within the triangle slices on the side looking through each other and span of semi-dome, there were located in the horizontal plane two oculus on the bottom four oculus on the upper side of curved surface.



Figure 2.15. Segmented semi-circular profiles in the semi-dome of east side iwan unit of Tire Tahtakale Hamamı *sıcaklık* main space.

### **2.2.6. Truncated-octogonal Pyramidal, on the Top Circular Depressed Profiles**

The profiles were formed by means of rising the octogonal pyramidal surfaces on the octogonal base up to a border in certain height in which pyramidal form truncated and then turning into circular depressed form at the top. The truncated-pyramidal on the top circular depressed profiles can be seen in the superstructure of *sıcaklık* main space of Urla Hersekzade Ahmet Paşa Hamamı women's section as the unique instance. In which the pyramidal form turning into the circular depressed, there is a border made of brick in the horizontal plane. In the bond of circular depressed form, bricks were stacked radially towards the arc center of circular form instead of center of whole dome.



Figure 2.16. Truncated-octagonal pyramidal, on the top circular depressed profiles in the dome of Urla Hersekzade Ahmet Paşa Hamamı women's section *sıcaklık* main space.

## 2.2.7. Pyramidal Profiles

Pyramidal profiles can be seen as two varieties: square-pyramidal profiles interior and octagonal-pyramidal profiles interior.

### 2.2.7.1. Square-pyramidal Profiles

Square-pyramidal profiles were formed as depressed pyramidal form interior and located on the flesh walls without using transition elements. For this reason it can be also called vault-dome (Yavuz 2002). The square-pyramidal profiles can be only seen in the superstructure of Tire Tahtakale Hamamı men's section *aralık* space (Figure 2.17). In this instance, in two of four surfaces rising toward the top in the horizontal plane two oculi were placed aligned with the horizontal line as a pair in the brick bond and surfaces were plastered with horasan. In the bond, the bricks were stacked for each surface separately in radial through the center of square frame of the pyramid in the horizontal rows up to the top. The square brick frames were narrowed along the top and ended with a top skylight in 36x36 centimeters sizes. At the corners in which the

surfaces combined with each other, the bricks were placed in the order of back to back. The exterior surface of the dome were coated with the horasan mortar including large and small pieces of bricks, stones and tiles and coated with traditional Turkish tiles at the end.

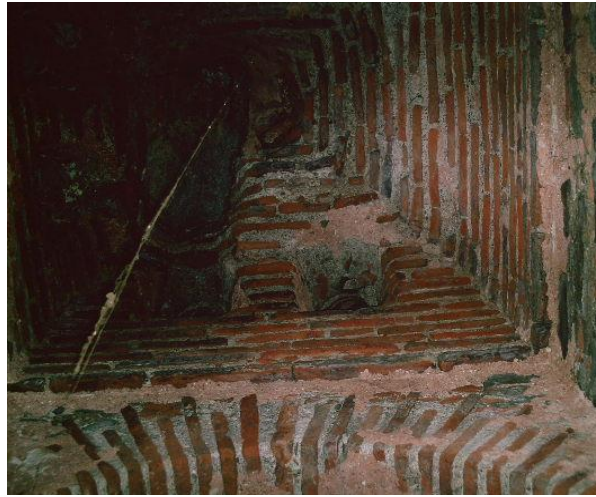

Figure 2.17. Square-pyramidal profiles in the dome of Tire Tahtakale Hamamı aralık space.

### 2.2.7.2. Octagonal-pyramidal Profiles

The domes with octagonal-pyramidal profiles were located on the octagonal frame formed by means of transition elements made of bricks and were increased in pyramidal formation from the springing level to the top. The brick bond rising to the top were ended with its final form of lighting cupolas made of half brick stacking radially through the center of hemispherical cupola. The octagonal-pyramidal profiles can be seen in the superstructures of Tire Tahtakale Hamamı men's section *ılıklik* sub-unit and square planned northwest iwan (Figure 2.18). The profile in the *ılıklik* sub-unit dome is in pointed formation whereas in the northwest iwan dome is in depressed formation.

Octagonal profiled domes were formed by means of four vaults that were made of brick and were intersected perpendicularly to each other. In between voids among them were infilled with large and small brick pieces and mortar as binding material. In the horizontal plane on each surface, in a one-circular row there was placed one oculus. At the top of dome, there are top skylight in the *ılıklik* sub-unit dome and lighting



cupola in the square planned iwan's dome. Interior surfaces were coated with thin horasan plaster, whereas exterior surfaces were coated with thick horasan mortar including small and large pieces of bricks and stones. Additionally, on the interior surfaces of iwan dome sunflower shaped ornament that is octagonal branched was arranged.



Figure 2.18. Octogonal-pyramidal profiles in the square planned dome of northwest iwan of Tire Tahtakale Hamamı men's section.

The most recognized pattern in this application is the star arrangement having geometrical or plant-inspired ornament at the center, and constituted by linear lines or profiles in the architecture of Anatolian Seljuks (Kolay 1999, p.97-98). The ornament production seen on the dome of square planned iwan in Tire Tahtakale Hamamı men's section can be pointed out that a similar application is come across in the depressed octogonal pyramidal dome of the iwan. This application may be evaluated as the only example which is also similar to the ornament applications on the vaults of Anatolian Seljuks architecture.

## CHAPTER 3

### EXAMINATION AND EVALUATION OF ARCHITECTURAL CHARACTERISTICS AND CONSTRUCTION TECHNIQUES IN THE DOMES

The morphological characteristics of the domes are defined by the terms in relation to geometrical characteristics such as span, height, profile, and additionally the construction techniques are defined by constructional characteristics such as material, bond type and thickness. Within this scope, on the first stage of the examination, the domes are defined and analyzed according to these morphological and structural characteristics: dome span, dome height, dome thickness, bond types, oculus alignment and number on the dome, type and height of the transition element to the dome and exterior supporting component. On the subsequent stage of the examination the relations between;

- Dome span-dome height
- Dome span-dome thickness
- Bond type-dome span-dome height
- Dome span-oculi alignment
- Dome span-number of oculi
- Dome span-height of the transition element to the dome
- Dome span-dome exterior supporting element height

are examined. Relations between the span, height, thickness, bond type, and number of oculus, oculus alignment and the transition element to the dome are evaluated through statistical analysis.

Thirty-six of the total seventy-nine domes examined in seventeen baths are *halvet* domes (Figure 3.1). Twenty of these are main *sıcaklık* space domes (Figure 3.2), nine are for the *ılıklik* main unit (Figure 3.3), seven are for the *ılıklik* sub-unit, six are for *soyunmalık* (Figure 3.4) and one dome is for *aralık* space. All domes except *soyunmalık* domes have the openings of oculi.

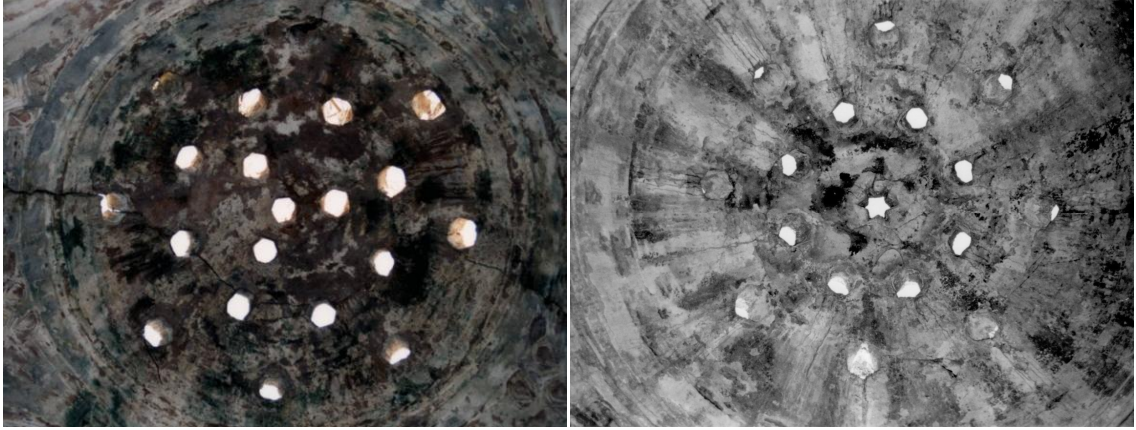

a

b

Figure 3.1. *Halvet* domes; (a) Kamanlı Hamamı, (b) Ulamış Hamamı.



a



b



c



d

Figure 3.2. The domes of *sıcaklık* main space; (a) Tire Tahtakale Hamamı, (b) Düzce (Hereke) Hamamı, (c) Tire Yalınayak Hamamı, (d) Seferihisar Büyük Hamamı.



a



b

Figure 3.3. *Ilıklık* main unit domes; (a) Tire Hekim Hamamı men's section, (b) Tire Tahtakale Hamamı men's section.



Figure 3.4. *Soyunmalık* dome (Tire Yalınayak Hamamı men's section).

Forty-six percent (46%) of the domes are in *halvet space*, 25% are in *sıcaklık* main space, 11% are in *ılıklık* main unit, 9% are in *ılıklık* sub-unit, 1% are in *aralık space* and 8% are *soyunmalık* space domes (Figure 3.5).

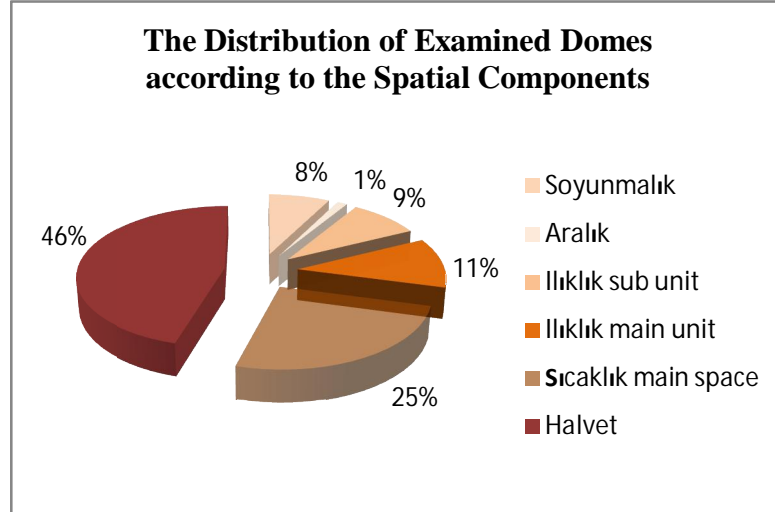

Figure 3.5. The distribution of examined domes according to the spatial components.

### 3.1. Examination of the Dome Spans

Domes which reside on walls or transition elements have spans related to the dimensions of the square or polygonal space that is covered. The dome spans, are grouped as follows (Figure 3.6) according to their spatial references with a determined equal interval of 2.5 meters, starting from the smallest span;

- Short-span domes between 0.95 and 3.45 meters, for *ılıkık*, *sıcaklık* main space and *halvet* domes
- Mid-span domes between 3.50 and 6.00 meters, for *ılıkık*, *sıcaklık* main space and *halvet* domes
- Long-span domes with 6.05 meters and above spans, for *sıcaklık* main space and *soyunmalık* domes.

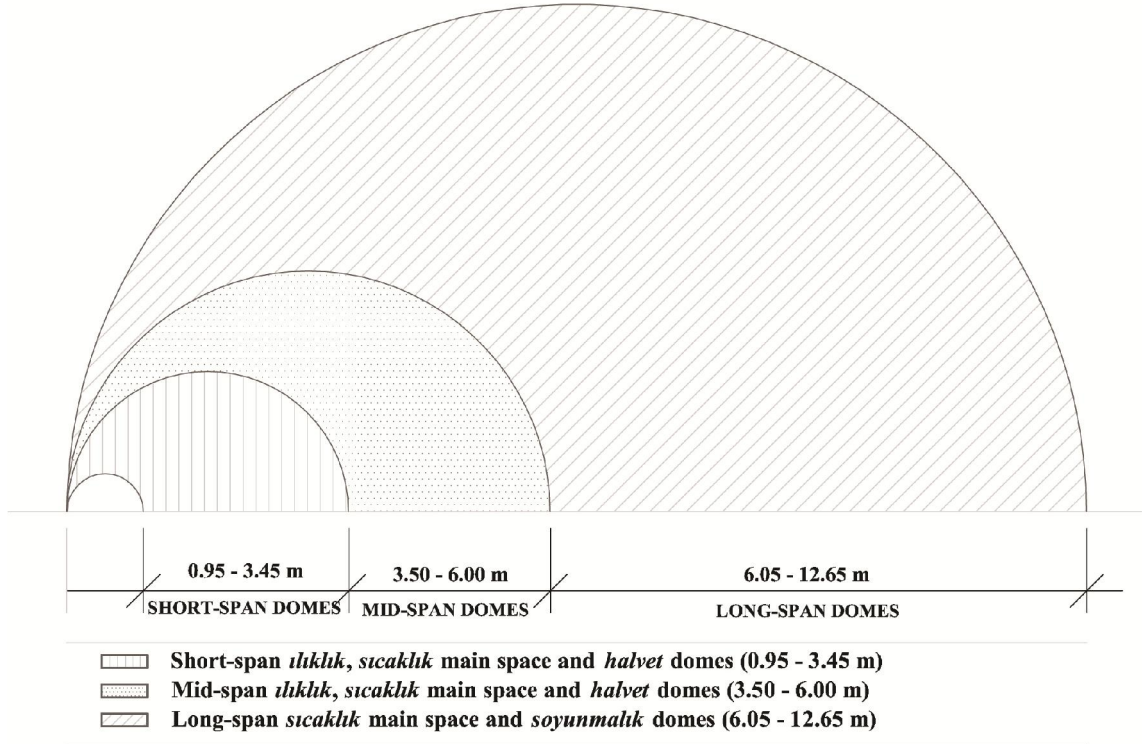

Figure 3.6. The groups of domes in investigated baths according to spans.

### 3.1.1. Range of Domes in Spaces in accordance with Spans

*Soyunmalik* domes have spans between 7.25-12.65 m, *ılıklik* domes between 0.95-5.50 m, *sıcaklık* main space domes between 2.20-7.80 m and *halvet* domes between 1.90-4.55 m (Table 3.1). *ılıklik* domes are *ılıklik* sub-unit and *ılıklik* main unit domes, which have spans of 0.95 to 2.75 and 1.75 to 5.50 meters respectively.

Table 3.1. The spans of domes in spaces.

Space	Span (m)	
	min	max
<i>Soyunmalik</i>	7.25	12.65
<i>ılıklik</i> main unit	1.75	5.50
<i>ılıklik</i> sub-unit	0.95	2.75
<i>Sıcaklık</i> main space	2.20	7.80
<i>Halvet</i>	1.90	4.55

In general, *ılıklik* and *halvet* domes are in short-span domes group, *sıcaklık* main space domes are in mid-span domes group and *soyunmalık* domes are in long-span domes group. Within all domes Tire Mehmet Ağa Hamamı *ılıklik* sub-unit dome has the shortest span (0.95 m) while Tire Tahtakale Hamamı men's section *soyunmalık* dome has the longest span (12.65 m).

All *soyunmalık* domes are long-span domes. Within these domes Düzce (Hereke) Hamamı with 7.25 m span is a sample of shortest span, Tire Tahtakale Hamamı with 12.65 m span is a sample of longest span (Table 3.2).

Table 3.2. The long-span *soyunmalık* domes.

Baths	Space	Span (m)	Height (m)
Düzce (Hereke) H.	Soyunmalık	7.25	3.15
Seferihisar Büyük H.	Soyunmalık	7.40	3.20
Tire Yalınayak H.(W)	Soyunmalık	7.80	3.20
Tire Yalınayak H.(M)	Soyunmalık	8.20	3.57
Tire Eski-Yeni H.(M)	Soyunmalık	10.25	5.10
Tire Tahtakale H. (M)	Soyunmalık	12.65	4.93

All *ılıklik* sub-unit domes are short-span domes. Within the *ılıklik* sub-unit domes, Tire Mehmet Ağa Hamamı women's section with 0.95 m span has the shortest span, Tire Hekim Hamamı women's section *ılıklik* sub-unit dome with 2.75 m span has the longest span (Table 3.3).

Table 3.3. Short span domes of *ılıklik* sub-units.

Baths	Space	Span (m)	Height (m)
Tire Mehmet Ağa H.(W)	<i>Ilıklık</i> sub-unit	0.95	not determined
Tire Mehmet Ağa H.(M)	<i>Ilıklık</i> sub-unit	1.15	not determined
Seferihisar Büyük H.	<i>Ilıklık</i> sub-unit	1.35	0.60
Tire Yeniceköy H.	<i>Ilıklık</i> sub-unit	2.20	0.94
Urla Hersekzade Ahmet Paşa H.(W)	<i>Ilıklık</i> sub-unit	2.25	1.01
Tire Tahtakale H.(M)	<i>Ilıklık</i> sub-unit	2.35	0.81
Tire Hekim H.(W)	<i>Ilıklık</i> sub-unit	2.75	0.91

*Ilıklık* main unit domes are short and mid-span domes. Among the *ilıklık* main unit domes, mid-span ones are Tire Karagazi Hamamı men's and women's section have spans of 5.50 meters and 4.50 meters respectively and Tahtakale Hamamı men's section has a span of 4.08 meters; while short span ones are Urla Çifte (Hersekzade Ahmet Paşa) Hamamı women's section and men's section with spans of 2.25 and 3.00 meters respectively, Urla Kamanlı Hamamı with a span of 2.95 meters, Seferihisar Büyük Hamam with a span of 1.75 meters, Tire Hekim Hamamı men's section and women's section with 3.40 and 2.76 meters respectively. Generally, *ilıklık* main unit domes have short-spans between 1.75-3.40 m. However, the *ilıklık* main unit domes are mid-span in Tire Tahtakale Hamamı men's section with span of 4.08 meters and in Tire Karagazi Hamamı women's and men's sections, with spans of 4.50 and 5.50 meters respectively (Table 3.4).

Table 3.4. The short and mid-span domes of *ilıklık* main units.

<b>Baths</b>	<b>Space</b>	<b>Span (m)</b>	<b>Height(m)</b>
Seferihisar Büyük H.	<i>Ilıklık</i> main unit	1.75	0.80
Urla Hersekzade Ahmet Paşa H.(W)	<i>Ilıklık</i> main unit	2.25	0.75
Tire Hekim H.(W)	<i>Ilıklık</i> main unit	2.76	1.10
Urla Kamanlı H.	<i>Ilıklık</i> main unit	2.95	collapsed
Urla Hersekzade Ahmet Paşa H.(M)	<i>Ilıklık</i> main unit	3.00	1.60
Tire Hekim H.(E)	<i>Ilıklık</i> main unit	3.40	1.49
<b>Tire Tahtakale H. (M)</b>	<b><i>Ilıklık</i> main unit</b>	<b>4.08</b>	<b>1.77</b>
<b>Tire Karagazi H.(W)</b>	<b><i>Ilıklık</i> main unit</b>	<b>4.50</b>	<b>collapsed</b>
<b>Tire Karagazi H.(M)</b>	<b><i>Ilıklık</i> main unit</b>	<b>5.50</b>	<b>collapsed</b>

Short-span domes  
Mid-span domes

*Sıcaklık* main space domes are; short, medium and long-span domes (Table 3.5). Among the *sıcaklık* main space domes, Sığacık Kaleiçi Hamamı is a sample of shortest span with 2.20 meters; Tire Yalınayak Hamamı is a sample of longest span with 7.80 meters. Among the 18 examined *sıcaklık* main space domes; 9 of them are short-span domes between 2.20 and 3.50 meters, 8 of them are mid-span between 3.50 and 5.30 meters. Tire Yalınayak Hamamı is the only example of long-span with 7.80 meters.



Table 3.5. Short, mid and long-span domes of *sıcaklık* main spaces.

<b>Baths</b>	<b>Space</b>	<b>Span (m)</b>	<b>Height (m)</b>
Sığacık Kaleiçi H.	<i>Sıcaklık</i> main space	2.20	0.95
Urla Özbek Köyü H.	<i>Sıcaklık</i> main space	2.40	1.00
Ulaş H.	<i>Sıcaklık</i> main space	2.71	1.26
Seferihisar Küçük H.	<i>Sıcaklık</i> main space	2.90	1.50
Mehmet Ağa H.(W)	<i>Sıcaklık</i> main space	2.90	1.25
Seferihisar Büyük H.	<i>Sıcaklık</i> main space	2.95	1.10
Tire Şeyh H.	<i>Sıcaklık</i> main space	3.00	1.18
Mehmet Ağa H.(W)	<i>Sıcaklık</i> main space	3.00	1.28
Tire Hekim H.(M)	<i>Sıcaklık</i> main space	3.05	1.51
Tire Tahtakale H.(M)	<i>Sıcaklık</i> main space	3.40	1.49
<b>Düzce (Hereke) H.</b>	<b><i>Sıcaklık</i> main space</b>	<b>3.50</b>	<b>1.76</b>
<b>Urla Hersekzade Ahmet Paşa H.(M)</b>	<b><i>Sıcaklık</i> main space</b>	<b>3.55</b>	<b>collapsed</b>
<b>Urla Kamanlı H.</b>	<b><i>Sıcaklık</i> main space</b>	<b>3.56</b>	<b>1.10</b>
<b>Urla Hersekzade Ahmet Paşa H.(W)</b>	<b><i>Sıcaklık</i> main space</b>	<b>3.70</b>	<b>1.90</b>
<b>Tire Hekim H.(W)</b>	<b><i>Sıcaklık</i> main space</b>	<b>3.70</b>	<b>1.44</b>
<b>Tire Yeniceköy H.</b>	<b><i>Sıcaklık</i> main space</b>	<b>3.70</b>	<b>1.46</b>
<b>Tire Mehmet Ağa H.(M)</b>	<b><i>Sıcaklık</i> main space</b>	<b>3.85</b>	<b>1.64</b>
<b>Tire Karagazi H.(M)</b>	<b><i>Sıcaklık</i> main space</b>	<b>4.70</b>	<b>collapsed</b>
<b>Urla Rüstem Paşa H.</b>	<b><i>Sıcaklık</i> main space</b>	<b>5.30</b>	<b>3.51</b>
<b>Tire Yalınayak H.(M)</b>	<b><i>Sıcaklık</i> main space</b>	<b>7.80</b>	<b>2.56</b>

Short-span domes

Mid-span domes

Long-span domes

*Halvet* domes are short and mid-span domes (Table 3.6). Among the *halvet* domes Seferihisar Küçük Hamam has the shortest-span with 1.90 meters, and Tire Karagazi Hamamı men's section has the longest span with 4.55 meters. Among the thirty-six *halvet* domes that were examined twenty-two samples are short-span between 1.90 and 3.45 meters and fourteen samples are mid-span between 3.50 and 4.55 meters.

Table 3.6. The short and mid-span *halvet* domes.

<b>Baths</b>	<b>Space</b>	<b>Span (m)</b>	<b>Height (m)</b>
Seferihisar Küçük H.	<i>Halvet</i>	1.90	0.90
Düzce (Hereke) H.	<i>Halvet</i>	2.05	collapsed
Sığacık Kaleiçi H.	<i>Halvet</i>	2.16	0.65
Urla Kamanlı H.	<i>Halvet</i>	2.17	1.50
Sığacık Kaleiçi H.	<i>Halvet</i>	2.23	0.70
Urla Özbek Köyü H.	<i>Halvet</i>	2.25	0.87
Urla Özbek Köyü H.	<i>Halvet</i>	2.28	0.87
Tire Yalınayak H.(M)	<i>Halvet</i>	2.50	0.58
Tire Yalınayak H.(M)	<i>Halvet</i>	2.50	0.98
Tire Yalınayak H.(M)	<i>Halvet</i>	2.55	0.76
Ula miş H.	<i>Halvet</i>	2.78	1.10
Urla Kamanlı H.	<i>Halvet</i>	2.87	2.01
Ula miş H.	<i>Halvet</i>	2.87	1.30
Tire Mehmet Ağa H.(W)	<i>Halvet</i>	2.90	1.22
Düzce (Hereke) H.	<i>Halvet</i>	2.90	1.40
Seferihisar Büyük H.	<i>Halvet</i>	2.95	1.20
Seferihisar Büyük H.	<i>Halvet</i>	2.95	1.15
Düzce (Hereke) H.	<i>Halvet</i>	2.95	collapsed
Urla Hersekzade Ahmet Paşa H.(M)	<i>Halvet</i>	3.00	1.50
Tire Şeyh H.	<i>Halvet</i>	3.00	collapsed
Tire Mehmet Ağa H.(W)	<i>Halvet</i>	3.00	1.12
Urla Kamanlı H.	<i>Halvet</i>	3.03	1.17
<b>Tire Yeniceköy H.</b>	<i>Halvet</i>	<b>3.50</b>	<b>1.57</b>
<b>Urla Hersekzade Ahmet Paşa H.(M)</b>	<i>Halvet</i>	<b>3.50</b>	<b>collapsed</b>
<b>Tire Yeniceköy H.</b>	<i>Halvet</i>	<b>3.50</b>	<b>1.35</b>
<b>Urla Hersekzade Ahmet Paşa H.(W)</b>	<i>Halvet</i>	<b>3.52</b>	<b>1.65</b>
<b>Urla Hersekzade Ahmet Paşa H.(W)</b>	<i>Halvet</i>	<b>3.56</b>	<b>1.64</b>
<b>Tire Tahtakale H.(M)</b>	<i>Halvet</i>	<b>3.60</b>	<b>1.51</b>
<b>Tire Tahtakale H.(M)</b>	<i>Halvet</i>	<b>3.60</b>	<b>1.51</b>
<b>Urla Hersekzade Ahmet Paşa H.(M)</b>	<i>Halvet</i>	<b>3.60</b>	<b>collapsed</b>
<b>Tire Hekim H.(M)</b>	<i>Halvet</i>	<b>3.70</b>	<b>1.44</b>
<b>Tire Mehmet Ağa H.(M)</b>	<i>Halvet</i>	<b>3.70</b>	<b>2.81</b>

(cont. on next page)

Table 3.6. (cont.)

<b>Tire Mehmet Ağa H.(M)</b>	<i>Halvet</i>	<b>3.70</b>	<b>1.91</b>
<b>Seferihisar Küçük H.</b>	<i>Halvet</i>	<b>3.79</b>	<b>1.80</b>
<b>Tire Yalınayak H.(M)</b>	<i>Halvet</i>	<b>4.35</b>	<b>1.46</b>
<b>Tire Karagazi H.(M)</b>	<i>Halvet</i>	<b>4.55</b>	<b>collapsed</b>

Short-span domes  
Mid-span domes

### 3.1.2. Evaluation of the Domes according to their Spans

Among the seventy-nine examined domes; forty-five are short-span, twenty-seven are mid-span and seven are long-span domes. As a result, short-span domes, mid-span domes, and long-span domes represent 57%, 34% and 9% of the examined domes, respectively (Figure 3.7).

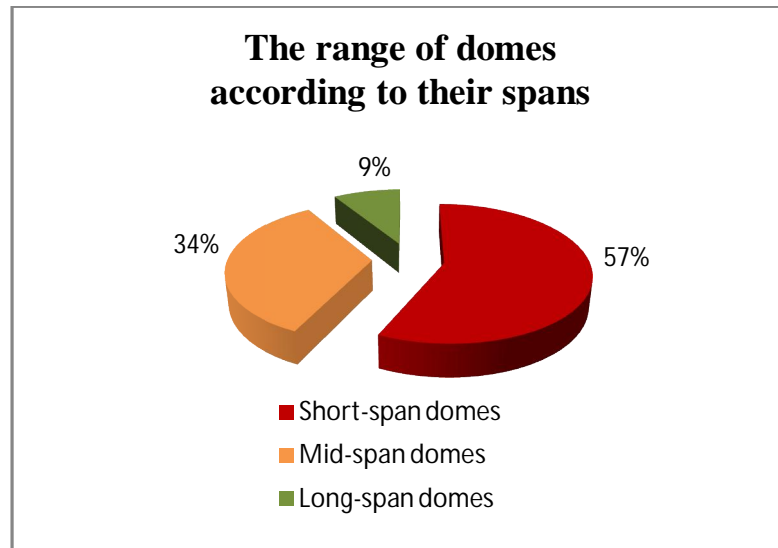

Figure 3.7. The range of domes according to their spans.

The distribution of domes according to their spans in spatial components is presented in Table 3.7. Forty-five short-span domes are distributed as twenty-two *halvet* domes, nine *sıcaklık* main space domes, six *ılıklik* main unit domes, seven *ılıklik* sub-unit domes, and one *aralık* dome. Among the twenty-seven mid-span domes 14 are

*halvet*, 10 are *sıcaklık* main space and 3 are *ılıkılık* main unit domes. The total 7 long span domes are composed of one *sıcaklık* main space dome and 6 *soyunmalık* domes.

Table 3.7. The distribution of domes in spaces according to their spans.

<b>Domes</b>	<i>Soyunmalık</i>	<i>Aralık</i>	<i>ılıkılık</i> sub-unit	<i>ılıkılık</i> main unit	<i>Sıcaklık</i> main space	<i>Halvet</i>	<b>Total</b>	<b>Range (%)</b>
Short-span domes	0	1	7	6	9	22	45	57%
Mid-span domes	0	0	0	3	10	14	27	34%
Long-span domes	6	0	0	0	1	0	7	9%
Total	6	1	7	9	20	36	79	100%

The amounts of short-span, mid-span and long-span domes in each spatial component of baths are given in Figure 3.8. Consequently, among the *halvet* domes twenty-two are short-span and fourteen are mid-span, among the *sıcaklık* main space domes nine are short-span, ten are mid-span domes and one is long-span dome. *ılıkılık* main unit domes have a distribution of six short-span and three mid-span domes. Finally, seven of *ılıkılık* sub-unit domes short-span and six of the *soyunmalık* domes are long-span domes.

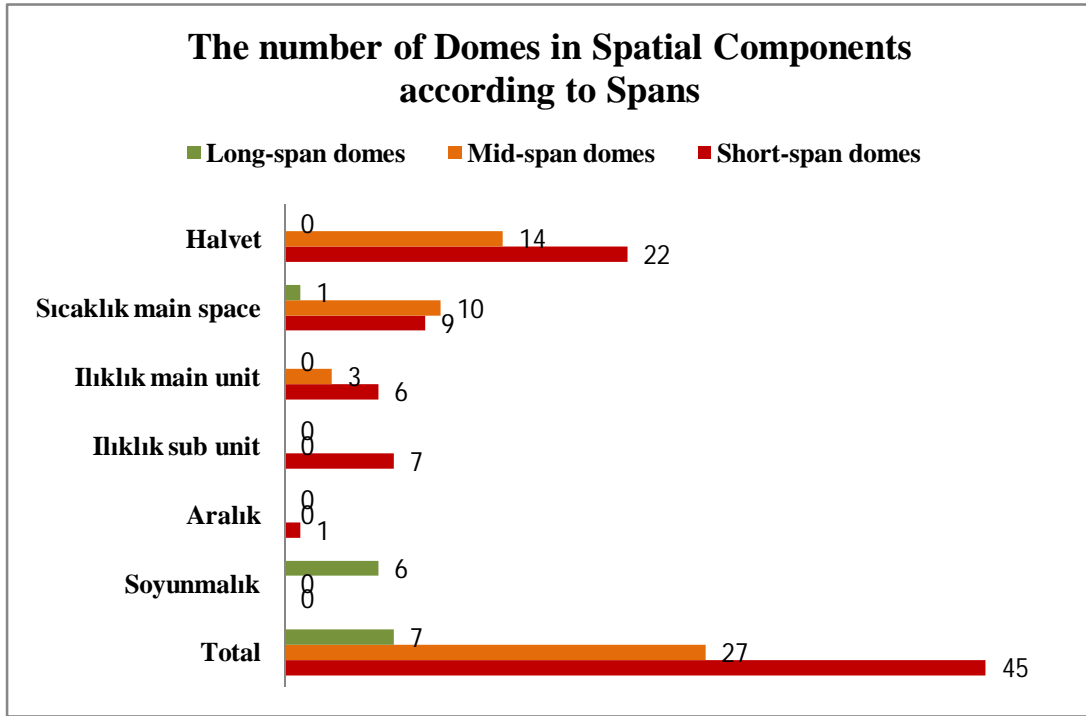

Figure 3.8. The number of domes in spatial components according to spans.

The distribution of domes according to their spans in spatial components of baths point out that, short-span and mid-span *halvet* domes that are the highest in number, additionally they occupy 49% among the short-span domes and 52% among the mid-span domes. The short, mid, and long-span *sıcaklık* main space domes are 20% of the short-span, 37% of the mid-span and 14% of the long-span domes. *Ilıklık* space domes which consist of *ilıklık* main and sub units occupy a total of 29% of small-span domes, with 13% of *ilıklık* main unit and 16% of *ilıklık* sub unit. Additionally, among mid-span domes, they occupy 11% as only *ilıklık* sub unit. The ratio of long-span *soyunmalık* domes among the long-span domes is 86% (Table 3.8).

Table 3.8. The distribution ratio of domes in spatial components according to spans.

Baths	<i>Soyunmalık</i>	<i>Aralık</i>	<i>Ilıklık</i> sub unit	<i>Ilıklık</i> main unit	<i>Sıcaklık</i> main space	<i>Halvet</i>	Total
Short span domes	0%	2%	16%	13%	20%	49%	100%
Mid-span domes	0%	0%	0%	11%	37%	52%	100%
Long span domes	86%	0%	0%	0%	14%	0%	100%

Long span domes do not contain any *ılıklik* and *halvet* domes. Additionally, there are no *soyunmalik* domes among the mid and short-span domes. As the domes are examined according to their distribution in spatial components, (Figure 3.9a), it is found that, of long-span *sıcaklık* main space and *soyunmalik* domes *sıcaklık* main space domes occupy 14% and *soyunmalik* domes occupy 86% of the whole long-span domes while *sıcaklık* main space domes occupy 25% and *soyunmalik* domes occupy 8% of the total domes (Figure 3.9b). Among the mid-span *ılıklik* main unit, *sıcaklık* main space, and *halvet* domes, *ılıklik* main unit domes, *sıcaklık* main space domes and *halvet* domes occupy respectively 11%, 25% and 46% of the total number of domes that are examined while the percentage of these types in the mid-span category are 11%, 37% and 52% respectively, (Figure 3.9c). Among the short-span *ılıklik* sub-unit, *ılıklik* main unit, *sıcaklık* main space and *halvet* domes, *ılıklik* sub-unit, *ılıklik* main unit, *sıcaklık* main space, and *halvet* domes occupy 9%, 11%, 25% and 46% of the total number of domes while the percentage of these domes in short-span category are 16%, 13%, 20% and 49% respectively. (Figure 3.9d).

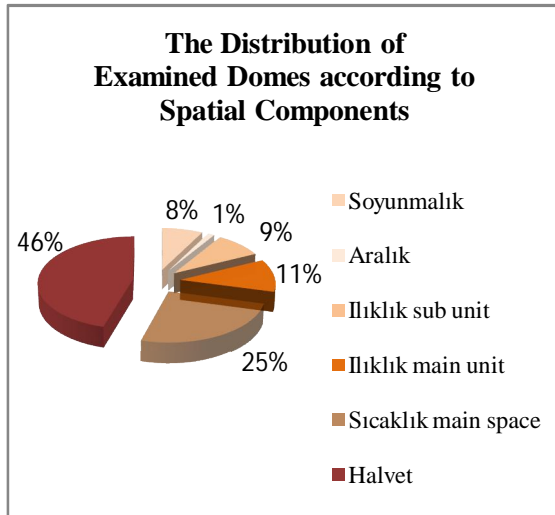

a. The Distribution of Examined Domes according to Spatial Components

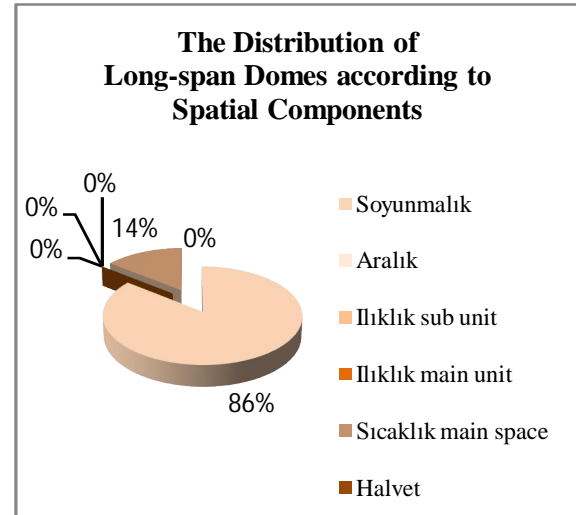

b. The Distribution of Long-span Domes according to Spatial Components

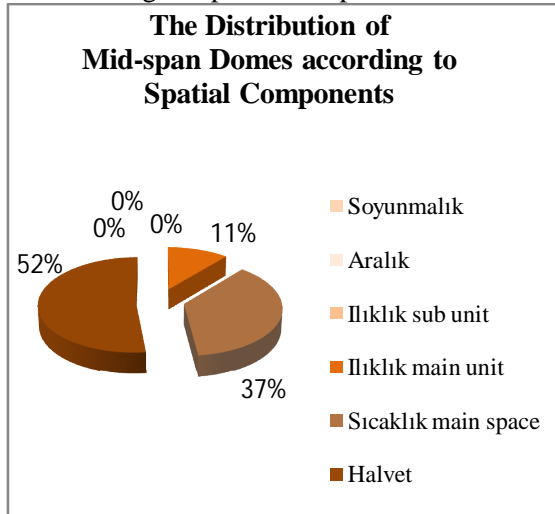

c. The Distribution of Mid-span Domes according to Spatial Components

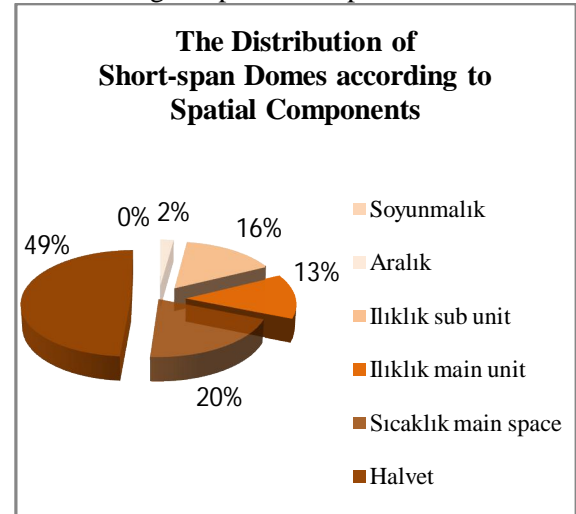

d. The Distribution of Short-span Domes according to Spatial Components

Figure 3.9. The distribution of examined domes with short, mid, and long spans according to spatial components.

The short-span domes which cover 57% of the total number of examined domes constitutes the superstructure in all spatial components except of the *soyunmalık* space, the mid-span domes which cover 34%, constitutes the superstructure in *ıllıklık* main unit, *sıcaklık* main space and *halvets*, the long-span domes which cover 9%, constitutes the superstructure in *sıcaklık* main space and *soyunmalık* spaces. The short-span and mid-span *halvet* domes which cover 46% of the total number of domes cover 28% of the short-span domes and 18% of the mid-span domes. *Sıcaklık* main space domes that cover 25% of the total number of domes constitute 11% of the short-span domes, 13%

of the mid-span domes, 1% of the long-span domes. *Ilıklık* main unit domes represent 11% of the total number of domes while covering 7% of the short-span domes and 4% of the mid-span domes. On the other hand, *ilıklık* sub unit domes that constitute 9% of the total number of domes are all short-span and they represent 9% of the short-span domes. *Soyunmalık* domes, which are all long-span occupy 8% of the total number of domes that were examined (Table 3.9).

Table 3.9. Within the all domes, the distribution ratio of domes in spatial components according to their spans.

Domes	<i>Soyunmalık</i>	<i>Aralık</i>	<i>Ilıklık</i> sub-unit	<i>Ilıklık</i> main unit	<i>Sıcaklık</i> main space	<i>Halvet</i>	Total
Short span domes	0%	<b>1.14%</b>	<b>9.12%</b>	<b>7.41%</b>	<b>11.4%</b>	<b>27.93%</b>	57%
Mid span domes	0%	0%	0%	<b>3.74%</b>	<b>12.58%</b>	<b>17.68%</b>	34%
Long span domes	<b>7.74%</b>	0%	0%	0%	<b>1.26%</b>	0%	9%
Total	7.74%	1.14%	9.12%	11.15%	25.24%	45.61%	100%

Among the *soyunmalık* domes, octagonal planned Tire Tahtakale Hamamı (Figure 3.10) domes (12.65m) and among the *sıcaklık* main space domes, octagonal planned Tire Yalınayak Hamamı domes (7.80m) have the longest-spans. This situation can be explained through the octagonal plan type.

In the mid-span *ilıklık* domes of Tire Hekim Hamamı men's section (Figure 3.11) and Tire Karagazi Hamamı mens's section, which are samples with a plan scheme of "equal cells", the span is identical with the dimensions of *sıcaklık* main space and *halvet* domes.



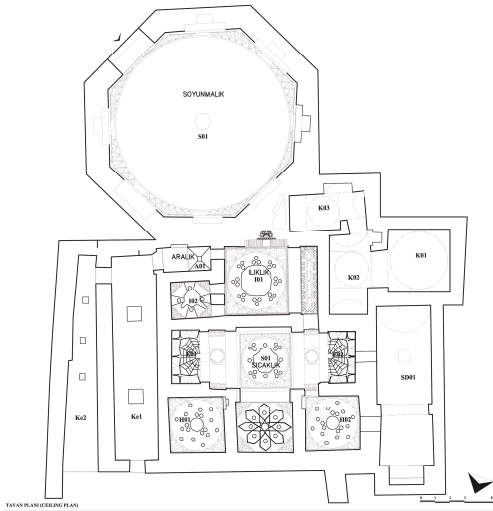

Figure 3.10. The plan of Tire Tahtakale Hamamı (taken from the achieve of İYTE\_ The Department of Architectural Restoration, 2007) and the exterior view of superstructure.

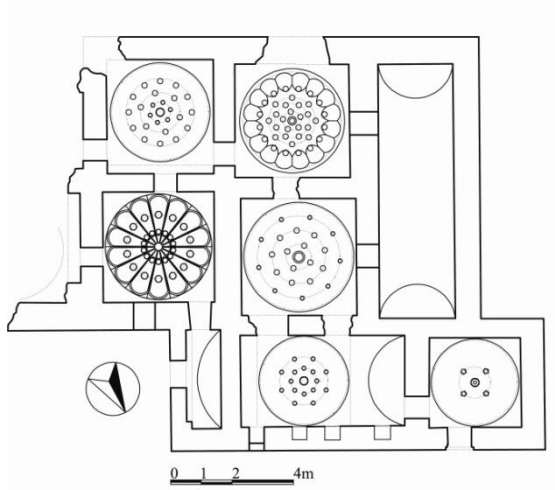

Figure 3.11. The plan of Tire Hekim Hamamı and the exterior view of the hamam.

### 3.2. Examination of Dome Heights

Dome heights were examined as associating with the dome spans. The height was determined between 0.58 and 2.01 meters for short-span, 1.10 and 2.81 meters for mid-span and 3.15 and 5.10 meters for long-span domes (Figure 3.12), (Table 3.10). Tire Yalınayak Hamamı *halvet* dome with 0.58 meters has the smallest height and Tire

Eski-Yeni Hamam *soyunmalık* dome with 5.10 meters has the largest height among the examined domes.

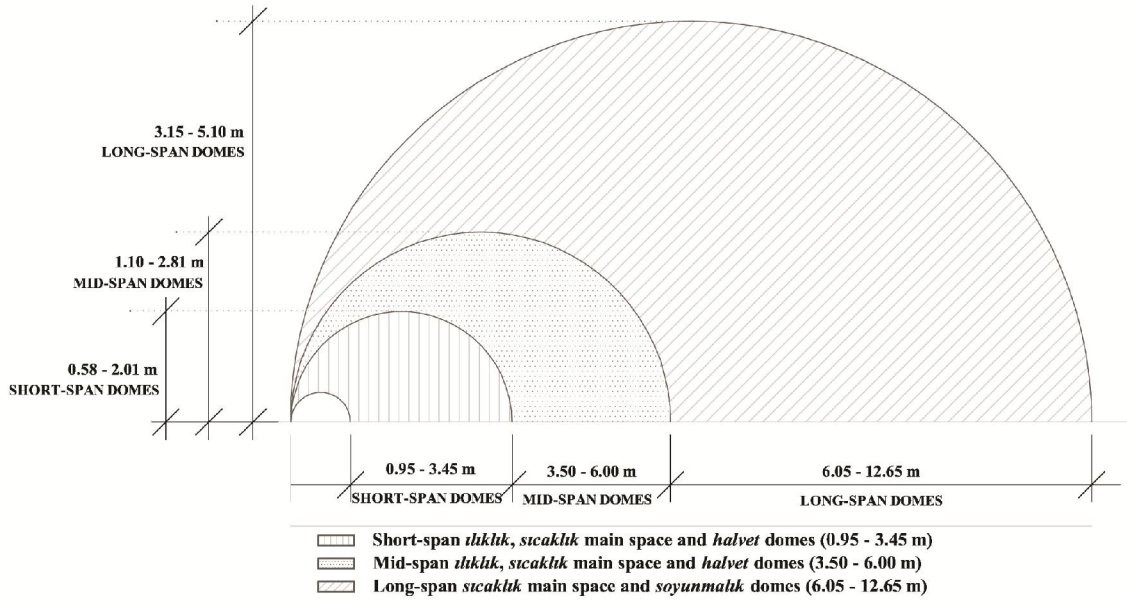

Figure 3.12. The heights of examined domes according to the spans.

Table 3.10. The distribution of heights of domes according to the spans.

Baths	Span (m)	Height (m)
Short-span domes	0.95 - 3.45	0.58 - 2.01
Mid-span domes	3.50 - 6.00	1.10 - 2.81
Long-span domes	6.05 - 12.65	3.15 - 5.10

### 3.2.1. Examination of the Relationship between Dome Spans and Dome Height in Domes

The dome height differentiates between; 3.15 and 5.10 meters for long-span *soyunmalık* domes; 0.75 and 1.77 meters for short and mid-span *ilıklık* main unit domes; 0.60 and 1.01 meters for all short-span *ilıklık* sub unit domes; 0.95 and 3.51 meters for short, mid and long-span *sıcaklık* main space domes; and 0.58 and 2.81 meters for short and mid span *halvet* domes (Table 3.11). However a single sample for the mid-span

*ılıklik* main unit domes, Tire Tahtakale Hamamı men's section *ılıklik* main unit dome height is 1.77 meters, and a single sample for long-span *sıcaklık* main space domes, Tire Yalınayak Hamamı men's section *sıcaklık* main space dome height is 2.56 meters.

Table 3.11. The dome heights according to the spatial components.

Space	Height (m)	
	min	max
Soyunmalık	3.15	5.10
<i>Ilıklık</i> main unit	0.75	1.77
<i>Ilıklık</i> sub-unit	0.60	1.01
<i>Sıcaklık</i> main space	0.95	3.51
<i>Halvet</i>	0.58	2.81

Düzce (Hereke) Hamamı's *soyunmalık* dome with a height of 3.15 meters is the the sample of the lowest height while Tire Eski-Yeni Hamam's *soyunmalık* dome with a height of 5.10 meters is the sample of the largest height among all the long-span *soyunmalık* dome examples (Table 3.12).

Table 3.12. The dome heights in long-span *soyunmalık* spaces.

Baths	Space	Span (m)	Height (m)
Düzce (Hereke) H.	<i>Soyunmalık</i>	7.25	3.15
Seferihisar Büyük H.	<i>Soyunmalık</i>	7.40	3.20
Tire Yalınayak H.(W)	<i>Soyunmalık</i>	7.80	3.20
Tire Yalınayak H.(M)	<i>Soyunmalık</i>	8.20	3.57
Tire Tahtakale H. (M)	<i>Soyunmalık</i>	12.65	4.93
Tire Eski-Yeni H.(M)	<i>Soyunmalık</i>	10.25	5.10

Among the short and mid-span *ılıklik* main unit domes, Urla Hersekzade Ahmet Paşa Hamamı women's section is the lowest sample with 0.75 m, Tire Tahtakale Hamamı men's section is the highest sample with 1.77 m (Table 3.13). Yet, Tire

Tahtakale Hamamı men's section *ılıklik* main unit dome which is the highest with 1.77 m is the unique mid-span sample.

Table 3.13. The heights in the short and mid-span *ılıklik* main spaces' domes.

Baths	Space	Span (m)	Height (m)
Urla Hersekzade Ahmet Paşa H.(W)	<i>ılıklik</i> main unit	2.25	0.75
Seferihisar Büyük H.	<i>ılıklik</i> main unit	1.75	0.80
Tire Hekim H.(W)	<i>ılıklik</i> main unit	2.76	1.10
Tire Hekim H.(M)	<i>ılıklik</i> main unit	3.40	1.49
Urla Hersekzade Ahmet Paşa H.(M)	<i>ılıklik</i> main unit	3.00	1.60
<b>Tire Tahtakale H. (M)</b>	<b><i>ılıklik</i> main unit</b>	<b>4.08</b>	<b>1.77</b>

The heights in the short-span domes

**The heights in the mid-span domes**

Among the *ılıklik* sub-unit domes all of which are short-span, Seferihisar Büyük Hamam is the lowest with 0.60 m, Urla Hersekzade Ahmet Paşa Hamamı women's section is the highest with 1.01 m (Table 3.14).

Table 3.14. The heights in the short-span *ılıklik* sub-units' domes.

Baths	Space	Span (m)	Height (m)
Seferihisar Büyük H.	<i>ılıklik</i> sub-unit	1.35	0.60
Tire Tahtakale H.	<i>ılıklik</i> sub-unit	2.35	0.81
Tire Hekim H.(W)	<i>ılıklik</i> sub-unit	2.75	0.91
Tire Yeniceköy H.	<i>ılıklik</i> sub-unit	2.20	0.94
Urla Hersekzade Ahmet Paşa H.(W)	<i>ılıklik</i> sub-unit	2.25	1.01

Among the eighteen short, mid and long-span *sıcaklık* main space domes, the short-span Urla Özbek Köyü Hamamı, Seferihisar Büyük and Küçük Hamams, Sığacık Kaleiçi Hamamı, Ulamış Hamamı, Tire Şeyh Hamamı and Tire Mehmet Ağa Hamamı women's section dome heights, Tire Hekim Hamamı men's section and Tire Tahtakale Hamamı men's section *sıcaklık* main space dome heights vary between 0.95 and 1.51

meters. Similarly the mid-span Urla Kamanlı Hamamı, Tire Hekim Hamamı women's section, Tire Yeniceköy Hamamı *sıcaklık* main space dome heights are between 0.95 and 1.51 meters. The heights of the mid-span Tire Mehmet Ağa Hamamı men's section, Düzce (Hereke) Hamamı and Urla Hersekzade Ahmet Paşa Hamamı women's section are between 1.64 and 1.90 meters. However mid-span Urla Rüstem Paşa Hamamı *sıcaklık* main space dome height is 3.51 meters and this height is within the long-span dome height values. In Tire Yalınayak Hamamı men's section, which is the unique example of long-span *sıcaklık* main space domes, the dome height was determined as 2.56 meters (Table 3.15). This height is within the mid-span dome height values.

Table 3.15. The heights of short, mid, and long-span domes of *sıcaklık* main spaces.

<b>Baths</b>	<b>Space</b>	<b>Span (m)</b>	<b>Height (m)</b>
Sığacık Kaleiçi H.	<i>Sıcaklık</i> main space	2.20	0.95
Urla Özbek Köyü H.	<i>Sıcaklık</i> main space	2.40	1.00
Seferihisar Büyük H.	<i>Sıcaklık</i> main space	2.95	1.10
<b>Urla Kamanlı H.</b>	<b><i>Sıcaklık</i> main space</b>	<b>3.56</b>	<b>1.10</b>
Tire Şeyh H.	<i>Sıcaklık</i> main space	3.00	1.18
Tire Mehmet Ağa H.(W)1	<i>Sıcaklık</i> main space	2.90	1.25
Ulamış H.	<i>Sıcaklık</i> main space	2.71	1.26
Tire Mehmet Ağa H.(W)2	<i>Sıcaklık</i> main space	3.00	1.28
<b>Tire Hekim H.(W)</b>	<b><i>Sıcaklık</i> main space</b>	<b>3.70</b>	<b>1.44</b>
<b>Tire Yeniceköy H.</b>	<b><i>Sıcaklık</i> main space</b>	<b>3.70</b>	<b>1.46</b>
Tire Tahtakale H. (M)	<i>Sıcaklık</i> main space	3.40	1.49
Seferihisar Küçük H.	<i>Sıcaklık</i> main space	2.90	1.50
Tire Hekim H.(M)	<i>Sıcaklık</i> main space	3.05	1.51
<b>Tire Mehmet Ağa H.(M)</b>	<b><i>Sıcaklık</i> main space</b>	<b>3.85</b>	<b>1.64</b>
<b>Düzce (Hereke) H.</b>	<b><i>Sıcaklık</i> main space</b>	<b>3.50</b>	<b>1.76</b>
<b>Urla Hersekzade Ahmet Paşa H.(W)</b>	<b><i>Sıcaklık</i> main space</b>	<b>3.70</b>	<b>1.90</b>
<b>Tire Yalınayak H.(M)</b>	<b><i>Sıcaklık</i> main space</b>	<b>7.80</b>	<b>2.56</b>
<b>Urla Rüstem Paşa H.</b>	<b><i>Sıcaklık</i> main space</b>	<b>5.30</b>	<b>3.51</b>

The heights in short-span domes  
**The heights in mid-span domes**  
*The heights in long-span domes*

Among the short and mid-span *halvet* domes, Tire Yalınayak Hamamı men's section dome is the lowest with 0.58 meters in height, Tire Mehmet Ağa Hamamı men's section dome is the highest with 2.81 meters in height. The heights of twenty short-span *halvet* domes vary between 0.58 and 2.01 meters. The heights of ten domes in eleven mid-span *halvet* domes are between 1.35 and 2.81 meters whereas Tire Mehmet Ağa Hamamı men's section *halvet* dome is 2.81 meters in height. Tire Yeniceköy Hamamı *halvet* dome with 1.35 meters, Tire Hekim Hamamı men's section *halvet* dome with 1.44 meters, and Tire Yalınayak Hamamı men's section *halvet* dome with 1.46 meters in height are the lowest mid-span *halvet* domes (Table 3.16). Except the mid-span Tire Mehmet Ağa Hamamı men's section *halvet* dome, all short and mid-span *halvet* domes have a height between 0.58 and 2.01 meters.

Table 3.16. The heights in the short and mid span *halvet* domes.

<b>Baths</b>	<b>Space</b>	<b>Span (m)</b>	<b>Height (m)</b>
Tire Yalınayak H.(E)	<i>Halvet</i>	2.50	0.58
Sığacık Kaleiçi H.	<i>Halvet</i>	2.16	0.65
Sığacık Kaleiçi H.	<i>Halvet</i>	2.23	0.70
Tire Yalınayak H.(E)	<i>Halvet</i>	2.55	0.76
Urla Özbek Köyü H.	<i>Halvet</i>	2.25	0.87
Urla Özbek Köyü H.	<i>Halvet</i>	2.28	0.87
Seferihisar Küçük H.	<i>Halvet</i>	1.90	0.90
Tire Yalınayak H.(M)	<i>Halvet</i>	2.50	0.98
Ulamış H.	<i>Halvet</i>	2.78	1.10
Mehmet Ağa H.(W)	<i>Halvet</i>	3.00	1.12
Seferihisar Büyük H.	<i>Halvet</i>	2.95	1.15
Urla Kamanlı H.	<i>Halvet</i>	3.03	1.17
Seferihisar Büyük H.	<i>Halvet</i>	2.95	1.20
Mehmet Ağa H.(W)	<i>Halvet</i>	2.90	1.22
Ulamış H.	<i>Halvet</i>	2.87	1.30
<b>Tire Yeniceköy H.</b>	<b><i>Halvet</i></b>	<b>3.50</b>	<b>1.35</b>
Düzce (Hereke) H.	<i>Halvet</i>	2.90	1.40
<b>Tire Hekim H.(M)</b>	<b><i>Halvet</i></b>	<b>3.70</b>	<b>1.44</b>

(cont. on next page)

Table 3.16. (cont.)

<b>Tire Yalınayak H.(M)</b>	<i>Halvet</i>	<b>4.35</b>	<b>1.46</b>
Urla Kamanlı H.	<i>Halvet</i>	2.17	1.50
Urla Hersekzade Ahmet Paşa H.(M)	<i>Halvet</i>	3.00	1.50
<b>Tire Tahtakale H. (M)</b>	<i>Halvet</i>	<b>3.60</b>	<b>1.51</b>
<b>Tire Tahtakale H. (M)</b>	<i>Halvet</i>	<b>3.60</b>	<b>1.51</b>
<b>Tire Yeniceköy H.</b>	<i>Halvet</i>	<b>3.50</b>	<b>1.57</b>
<b>Urla Hersekzade Ahmet Paşa H.(W)</b>	<i>Halvet</i>	<b>3.56</b>	<b>1.64</b>
<b>Urla Hersekzade Ahmet Paşa H.(W)</b>	<i>Halvet</i>	<b>3.52</b>	<b>1.65</b>
<b>Seferihisar Küçük H.</b>	<i>Halvet</i>	<b>3.79</b>	<b>1.80</b>
<b>Tire Mehmet Ağa H.(M)</b>	<i>Halvet</i>	<b>3.70</b>	<b>1.91</b>
Urla Kamanlı H.	<i>Halvet</i>	2.87	2.01
<b>Tire Mehmet Ağa H.(M)</b>	<i>Halvet</i>	<b>3.70</b>	<b>2.81</b>

The heights in short-span domes  
**The heights in mid-span domes**

### 3.2.2. Evaluation of the Relationship between Dome Spans and Dome Height in Domes

Within the study, spans and heights of the total 79 domes have been examined. In this examination of the relationship between the span and height of these domes, it is determined that the height increases linearly as the span increases. The linear relation between the span and the height can be seen in the chart given in Figure 3.13. Accordingly; the proportion of height to span is 42 centimeters of height for approximately 1 meters of span, thus the height is 4.2 m in 10 m span. Within this framework it can be asserted that the ratio of the height to the span is 0.42.

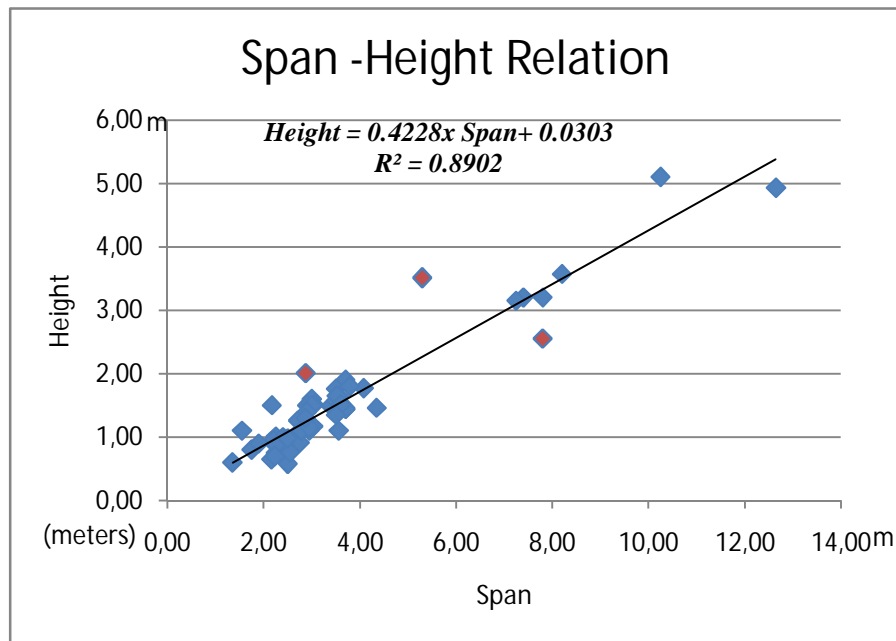

Figure 3.13. The relationship between span and height in all examined domes.

While short and mid-span domes, in which the relationship between span and height is linear, have the first group (see in 3.4.1.1) bond type (horizontal stacking of the short side faces in places non-parallel rows), long-span domes commonly have the second group (see in 3.4.1.2) bond type (horizontal and adjacent stacking of the short side faces in parallel rows).

In consequence of exclusion of three domes which are residuals in the linear span-height relation; the common span-height relation is presented in the chart in Figure 3.14.



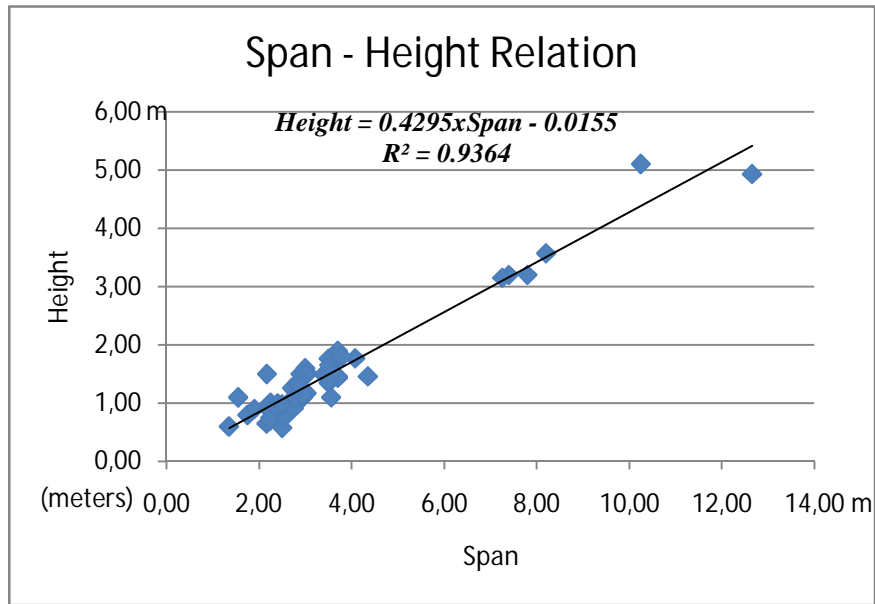

Figure 3.14. The common relationship between span and height in the examined domes.

Although domes that have linear span to height relation commonly have first group (*horizontal stacking of the short side faces in places non-parallel rows*) and second group (*horizontal and adjacent stacking of the short side faces in parallel rows*) bond types, the bond types in the residual three domes which deviate from linear proportion are different from each other. Tire Yalınayak Hamamı is an example for the third group bond type (*horizontal stacking of long faces on the bottom for a few rows and short faces on top in parallel rows*), Rüstem Paşa Hamamı is an example for the second group bond type (*horizontal and adjacent stacking of the short side faces in parallel rows*) and Urla Kamanlı Hamamı is an example for the first group bond type (*horizontal stacking of the short side faces in places non-parallel rows*). Therefore, as the bond types of each dome that deviate from linear proportion of span and height relation is different, it is possible to say that the bond type does not have a determinative effect on the span and height relation.

About the geometrical proportions of a Byzantian dome of St. Panteleimon Church in Thessaloniki, it is stated that the ratio of its height to its span is 0.43 (2.50 / 5.80 m) (Ignatakis C, Stylianidis K, Stavrakakis E 1993, pp.255-265). This ratio is similar to the values determined in the examined bath-domes, and has a value between the determined ratios of 0.40-0.48.

In the dome structures which have a linear proportion of span to the height an axial compression occurs in all directions on the dome surface from the top point of the dome to the bracings up to an approximate latitude of  $52^\circ$  (Cowan 1977; Mark 1993; Çamlıbel 1998; Mungan 2009) and tensile stress occurs on the surfaces below this level. Within the examined domes, it is noticed that in order to compensate the tensile stresses either polygonal elements that wrap the dome were used as external support or the bonding of the dome is continued within the wall and supported by the transition elements. In cases where the bond is not maintained within the wall it is observed that most of the domes have collapsed.

Eventually, within the examined domes, two methods were observed for compensating the aforementioned tensile stresses. In the first method, a dome exterior supporting component in polygonal form wrapping the dome was used. In the other method the dome bond is maintained to the latitude of  $52^\circ$  angle and supported by the transition components to the dome.

As a result of the examinations, it is revealed that there is a close relation between span, height, and bond type. Within this relation, as the rate of height to the span is different in the second group bond type according to the first group bond type, it is revealed that the bond type plays a determinative role.

In Çamlıbel's work (1998), it is emphasized that the structure has to be compatible with the characteristics of the material. Çamlıbel has important determinations on structures. According to Çamlıbel, the elements of the traditional building structure have to be designed as the elements having only compressive stresses. In order to create compressive stresses in the sections of the domes constituting the cover system, the part scanned by the  $(103^\circ)$ -central-angle has to be occupied as the covering element. If this angle increases, tensile stresses appear in the sections of the domes. In case that these stresses exceed the tensile resistance, the dome is subjected to cracks in the direction of meridian. In this situation, the springing level of the dome needs to be drummed to resist the tension. These tensile stresses reach the maximum level in the semi-spherical domes with  $(180^\circ)$ -central-angle. The dome of the Pantheon in Rome cracked at its springing level, and thus, was supported by means of an iron strap. Semi-domes cannot be recognized in Sinan's designs. This kind of design does not allow making openings in the springing level of the dome.

The fact that the central-angles exceed the  $(103^\circ)$  in some domes providing Sinan's domes (Cowan 1977; Çamlıbel 1998; Günay 2006; Mungan 2009) their

geometry causes tensile stresses in the springing level. The tensile stresses were fairly diminished in Sinan's domes because the springing level thickness was designed almost twice in size rather than the top section thickness.

This examination clarifies the situation of the large domes that, considering the same logic in the examined domes, the dome thickness in the springing level is almost twice in size in comparison to the thickness of the top. While the span-height (oblateness) ratios in bath-domes vary between 0.40 and 0.48, these values vary between 0.30 and 0.38 in Sinan's mosque-domes. This situation is important because it demonstrates that the mosque-domes with large spans were constructed in a more depressed style in comparison to the cases of bath-domes which have spans smaller than the mosques' ones. Besides, while in Sinan's mosque-domes the central-angles have the values between 110°-140°, in the bath-domes the central-angles almost vary between the same values for the total dome curve parts.

### 3.3. Examination of the Dome Thicknesses

Dome thicknesses were examined in relation to the dome spans similar to the dome heights. In short-span (0.95 to 3.45 meters) domes, the thickness is; 0.35 to 0.64 meters at springing level, 0.35 to 0.40 meters upwards and at dome peak; in mid-span (3.50 to 6.00 meters) domes the thickness is; 0.45 to 0.65 meters at springing level, 0.37 to 0.60 meters upwards, and 0.35 to 0.40 meters at dome peak; in long-span (6.05 and more) domes the thickness is; 0.60 to 0.76 meters at springing level, 0.50 to 0.60 meters upwards, and 0.35 to 0.40 meters at peak (Table 3.17). The dome thicknesses differentiate in springing level according to the dome spans and are mostly between 0.35 and 0.40 meters at dome peak. Therefore, the examinations and evaluations regarding the thickness are carried out in deference to the thickness at springing level.

Table 3.17. The thicknesses of the examined domes according to the spans.

<b>Baths</b>	<b>Span (m)</b>	<b>Thickness (m)</b>
Short-span domes	0.95 - 3.45	0.35 - 0.64
Mid-span domes	3.50 - 6.00	0.45 - 0.65
Long-span domes	6.05 - 12.65	0.60 - 0.76

### 3.3.1. Examination of the Relationship between Span and Thickness in Domes

In all examined long-span *soyunmalık* domes, the thickness is between 0.60 and 0.76 meters at springing level; in long, mid and short-span *sıcaklık* main space domes between 0.45 and 0.75 meters; in mid and short-span *ılıkılık* main unit domes between 0.35 and 0.62 meters. Additionally, in *ılıkılık* sub-unit domes, which are all short-span, dome thickness is between 0.35 and 0.64 meters and in mid and short-span *halvet* domes the thickness varies between 0.37 and 0.72 meters at springing level (Table 3.18). However, thickness of short-span Tire Hekim Hamamı men's section *halvet* dome is 0.73 meters. Tire Yalınayak Hamamı men's section *sıcaklık* main space dome, which is the only sample of the long-span, is 0.75 m in thickness. Considering the thickness measures given in Table 3.18; the thicknesses of the *ılıkılık*, *sıcaklık* main space and *halvet* domes are close to each other while *soyunmalık* dome thicknesses are higher.

Table 3.18. The thicknesses of domes at the springing level according to the spatial components.

Space	Thickness (m)	
	Min	Max
<i>Soyunmalık</i>	0.60	0.76
<i>Ilıklık</i> main unit	0.35	0.62
<i>Ilıklık</i> sub-unit	0.35	0.64
<i>Sıcaklık</i> main space	0.45	0.75
<i>Halvet</i>	0.37	0.72

Within the examined six long-span *soyunmalık* domes, Düzce (Hereke) Hamamı with 0.60 m in thickness is the thinnest sample; Tire Tahtakale Hamamı with 0.76 m in thickness is the thickest sample. Except the *soyunmalık* domes, the only example of long-span *sıcaklık* main space dome of Tire Yalınayak Hamamı men's section, has a thickness of 0.75 meters (Table 3.19).

Table 3.19. The thicknesses of long-span *soyunmalık* domes at the springing level.

Baths	Space	Span (m)	Thickness (m)
Düzce (Hereke) H.	Soyunmalık	7.25	0.60
Seferihisar Büyük H.	Soyunmalık	7.40	0.65
Tire Yalınayak H.(W)	Soyunmalık	7.80	0.70
Tire Yalınayak H.(M)	Soyunmalık	8.20	0.75
Tire Eski-Yeni H.(M)	Soyunmalık	10.25	0.75
Tire Tahtakale H.	Soyunmalık	12.65	0.76

Within the seven short-span domes of the examined ten *ıııklık* main unit domes, the thickness of the Urla Kamanlı Hamamı is the least with 0.35 meters, the thickness of the Tire Hekim Hamamı is the most with 0.58 meters. Thicknesses of the other three mid-span *ıııklık* main unit domes are; Tire Tahtakale Hamamı has 0.63 meters, Tire Karagazi Hamamı men's section has 0.53 meters and women's section has 0.63 meters thickness (Table 3.20).

Table 3.20. The thicknesses of short and mid-span *ıııklık* main unit domes at the springing level.

Baths	Space	Span (m)	Thickness (m)
Tire Hekim H.(M) in slice	<i>ıııklık</i> main unit	3.40	0.32
Urla Kamanlı H.	<i>ıııklık</i> main unit	2.95	0.40
Seferihisar Büyük H.	<i>ıııklık</i> main unit	1.75	0.45
Urla Hersekzade Ahmet Paşa H.(W)	<i>ıııklık</i> main unit	2.25	0.45
Tire Hekim H.(M)	<i>ıııklık</i> main unit	3.40	0.52
<b>Tire Karagazi H.(M)</b>	<b><i>ıııklık</i> main unit</b>	<b>5.50</b>	<b>0.53</b>
Tire Hekim H.(W)	<i>ıııklık</i> main unit	2.76	0.57
Urla Hersekzade Ahmet Paşa H.(M)	<i>ıııklık</i> main unit	3.00	0.57
<b>Tire Tahtakale H.</b>	<b><i>ıııklık</i> main unit</b>	<b>4.08</b>	<b>0.63</b>
<b>Tire Karagazi H.(W)</b>	<b><i>ıııklık</i> main unit</b>	<b>4.50</b>	<b>0.63</b>

The thicknesses of short-span domes

**The thicknesses of mid-span domes**

Among the seven short-span *ıııklık* sub-unit domes, the thickness of the Tire Yeniceköy Hamamı is the least with 0.35 meters, the thickness of the Tire Tahtakale Hamamı is the most with 0.64 meters (Table 3.21).

Table 3.21. The thicknesses of short-span *ılıklik* sub-unit domes at the springing level.

Baths	Space	Span (m)	Thickness (m)
Mehmet Ağa H.(W)	<i>ılıklik</i> sub unit	0.95	0.35
Mehmet Ağa H.(M)	<i>ılıklik</i> sub unit	1.15	0.35
Tire Yeniceköy H.	<i>ılıklik</i> sub unit	2.20	0.40
Seferihisar Büyük H.	<i>ılıklik</i> sub unit	1.35	0.45
Urla Hersekzade Ahmet Paşa H.(W)	<i>ılıklik</i> sub unit	2.25	0.45
Tire Tahtakale H.(M)	<i>ılıklik</i> sub unit	2.35	0.62
Tire Hekim H.(W)	<i>ılıklik</i> sub unit	2.75	0.64

Among seven mid-span domes of the total seventeen *sıcaklık* main space domes, the thickness of the Urla Kamanlı Hamamı is the least with 0.40 meters, the thickness of the Urla Hersekzade Ahmet Paşa Hamamı women's section is the largest with 0.60 meters. In nine short-span *sıcaklık* main space domes, Sığacık Kaleiçi Hamamı, Tire Şeyh Hamamı and Düzce (Hereke) Hamamı have least thicknesses with 0.38 meters, Tire Tahtakale Hamamı men's have the highest thickness with a value of 0.63 meters. Tire Yalınayak Hamamı men's section *sıcaklık* main space dome which is the only long-span example has a thickness of 0.75 meters (Table 3.22).

Table 3.22. The thicknesses of short, mid and long-span *sıcaklık* main space domes at the springing level.

Baths	Space	Span (m)	Thickness (m)
Sığacık Kaleiçi H.	<i>Sıcaklık</i> main space	2.20	0.37
Tire Şeyh H.	<i>Sıcaklık</i> main space	3.00	0.37
<b>Düzce (Hereke) H.</b>	<b><i>Sıcaklık</i> main space</b>	<b>3.50</b>	<b>0.37</b>
Ulaşmış H.	<i>Sıcaklık</i> main space	2.71	0.40
Seferihisar Küçük H.	<i>Sıcaklık</i> main space	2.90	0.40
<b>Urla Kamanlı H.</b>	<b><i>Sıcaklık</i> main space</b>	<b>3.56</b>	<b>0.40</b>
Seferihisar Büyük H.	<i>Sıcaklık</i> main space	2.95	0.42
<b>Tire Yeniceköy H.</b>	<b><i>Sıcaklık</i> main space</b>	<b>3.70</b>	<b>0.42</b>
<b>Urla Rüstem Paşa H.</b>	<b><i>Sıcaklık</i> main space</b>	<b>5.30</b>	<b>0.42</b>
Urla Özbek Köyü H.	<i>Sıcaklık</i> main space	2.40	0.45
Tire Hekim H.(M)	<i>Sıcaklık</i> main space	3.05	0.52
<b>Tire Hekim H.(W)</b>	<b><i>Sıcaklık</i> main space</b>	<b>3.70</b>	<b>0.52</b>
<b>Tire Karagazi H.(M)</b>	<b><i>Sıcaklık</i> main space</b>	<b>4.70</b>	<b>0.52</b>
<b>Urla Hersekzade Ahmet Paşa H.(M)</b>	<b><i>Sıcaklık</i> main space</b>	<b>3.55</b>	<b>0.57</b>

(cont. on next page)

Table 3.22. (cont.)

<b>Urla Hersekzade Ahmet Paşa H.(W)</b>	<i>Sıcaklık main space</i>	<b>3.70</b>	<b>0.60</b>
Tire Tahtakale H.	<i>Sıcaklık main space</i>	3.40	0.62
<b><i>Tire Yalınayak H.(M)</i></b>	<i>Sıcaklık main space</i>	<b>7.80</b>	<b>0.75</b>

Short-span domes

**Mid-span domes***Long-span domes*

Among the twenty-two short span samples of all examined *halvet* domes (thirty-two in total), Sığacık Kaleiçi Hamamı, Düzce (Hereke) Hamamı and Tire Şeyh Hamamı have the least thickness with a value of 0.38 meters while Tire Yalınayak Hamamı men's section *halvet* domes have the largest thickness of 0.58 meters. Within the ten mid-span *halvet* domes, Seferihisar Küçük Hamam has the least thickness with a value of 0.40 meters and Tire Hekim Hamamı men's section has the largest thickness of 0.73 meters (Table 3.23).

Table 3.23. The thicknesses of short and mid-span *halvet* domes at the springing level.

<b>Baths</b>	<b>Space</b>	<b>Span (m)</b>	<b>Thickness (m)</b>
Düzce (Hereke) H.	Halvet	2.05	0.37
Sığacık Kaleiçi H.	Halvet	2.16	0.37
Sığacık Kaleiçi H.	Halvet	2.23	0.37
Düzce (Hereke) H.	Halvet	2.90	0.37
Düzce (Hereke) H.	Halvet	2.95	0.37
Tire Şeyh H.	Halvet	3.00	0.37
Urla Kamanlı H.	Halvet	2.17	0.40
Ulamış H.	Halvet	2.78	0.40
Urla Kamanlı H.	Halvet	2.87	0.40
Ulamış H.	Halvet	2.87	0.40
Urla Kamanlı H.	Halvet	3.03	0.40
<b>Seferihisar Küçük H.</b>	<b>Halvet</b>	<b>3.79</b>	<b>0.40</b>
<b>Tire Yeniceköy H.</b>	<b>Halvet</b>	<b>3.50</b>	<b>0.42</b>
<b>Tire Yeniceköy H.</b>	<b>Halvet</b>	<b>3.50</b>	<b>0.42</b>
Seferihisar Küçük H.	Halvet	1.90	0.45
Urla Özbek Köyü H.	Halvet	2.28	0.45
Urla Özbek Köyü H.	Halvet	2.25	0.47
Seferihisar Büyük H.	Halvet	2.95	0.47

(cont. on next page)

Table 3.23. (cont.)

Seferihisar Büyük H.	Halvet	2.95	0.47
Urla Hersekzade Ahmet Paşa H.(M)	Halvet	3.00	0.47
<b>Urla Hersekzade Ahmet Paşa H.(M)</b>	<b>Halvet</b>	<b>3.50</b>	<b>0.52</b>
<b>Urla Hersekzade Ahmet Paşa H.(M)</b>	<b>Halvet</b>	<b>3.60</b>	<b>0.52</b>
<b>Tire Karagazi H.(M)</b>	<b>Halvet</b>	<b>4.55</b>	<b>0.52</b>
Tire Yalınayak H.(M)	Halvet	2.50	0.57
Tire Yalınayak H.(M)	Halvet	2.50	0.57
Tire Yalınayak H.(M)	Halvet	2.55	0.57
<b>Tire Yalınayak H.(M)</b>	<b>Halvet</b>	<b>4.35</b>	<b>0.57</b>
<b>Urla Hersekzade Ahmet Paşa H.(W)</b>	<b>Halvet</b>	<b>3.52</b>	<b>0.60</b>
<b>Urla Hersekzade Ahmet Paşa H.(W)</b>	<b>Halvet</b>	<b>3.56</b>	<b>0.60</b>
<b>Tire Tahtakale H.(M)</b>	<b>Halvet</b>	<b>3.60</b>	<b>0.62</b>
<b>Tire Tahtakale H. (M)</b>	<b>Halvet</b>	<b>3.60</b>	<b>0.62</b>
<b>Tire Hekim H.(M)</b>	<b>Halvet</b>	<b>3.70</b>	<b>0.73</b>

The thicknesses of short-span domes at springing level  
**The thicknesses of mid-span domes at springing level**

Among the seventy-two examined domes, the springing level thicknesses are between 0.60 and 0.76 meters in long-span domes, and between 0.35 and 0.65 meters in forty-nine short-span and sixteen mid-span domes. The long-span domes are approximately 0.25 meters thicker than the short and mid-span domes.

### **3.3.2. Evaluation of the Relationship between Span and Thickness in Domes**

Dome thickness is related to the bond types that alter according to the dome span. The factors that lead the differentiation of the thicknesses applied are one row brick (Figure 3.15), double row brick (Figure 3.16), transition from double to one row along thickness (Figure 3.17), and thick plaster (the first layer 8-12 cm the upper layer 2-3 cm) over one row brick (Figure 3.18) in the dome section.



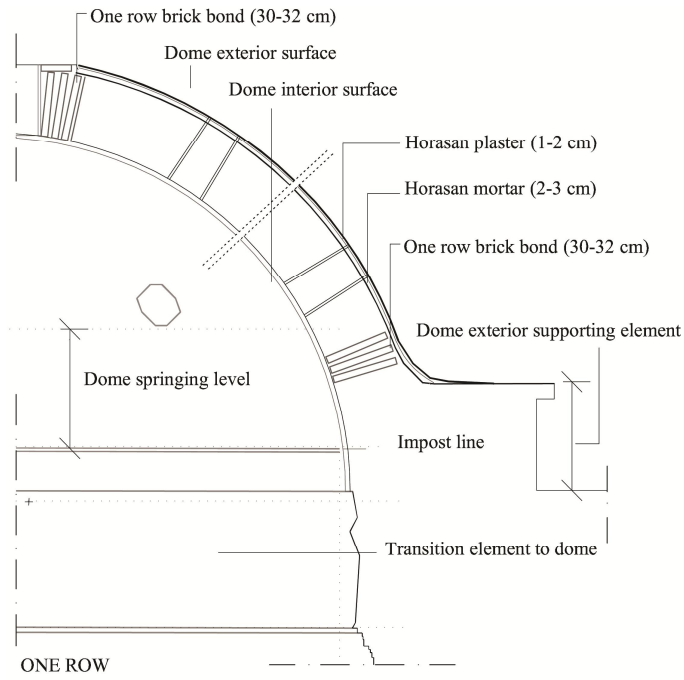

Figure 3.15. One row brick application in dome thickness.

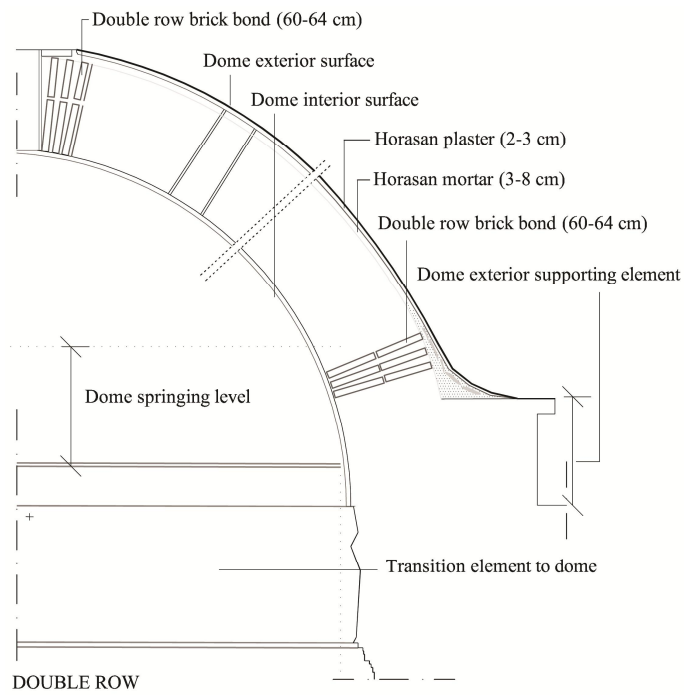

Figure 3.16. Double row brick application in dome thickness.

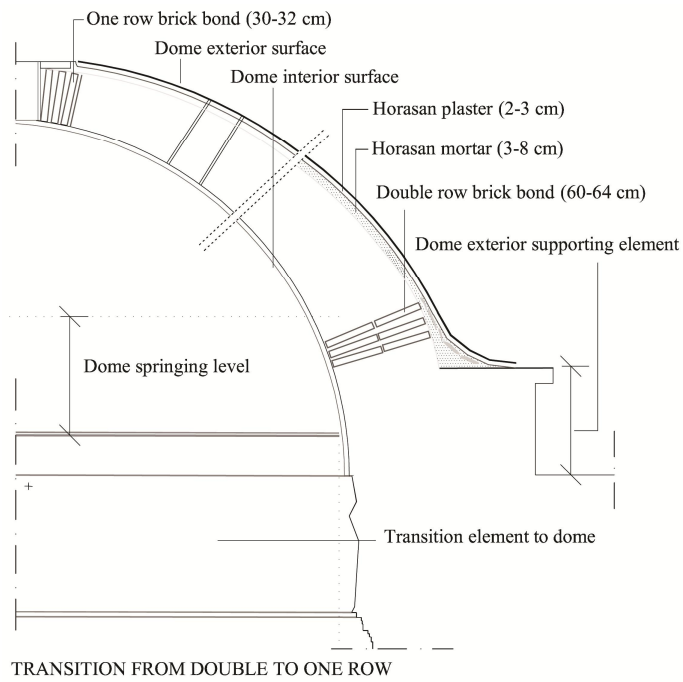

Figure 3.17. Transition from double to one row brick along thickness.

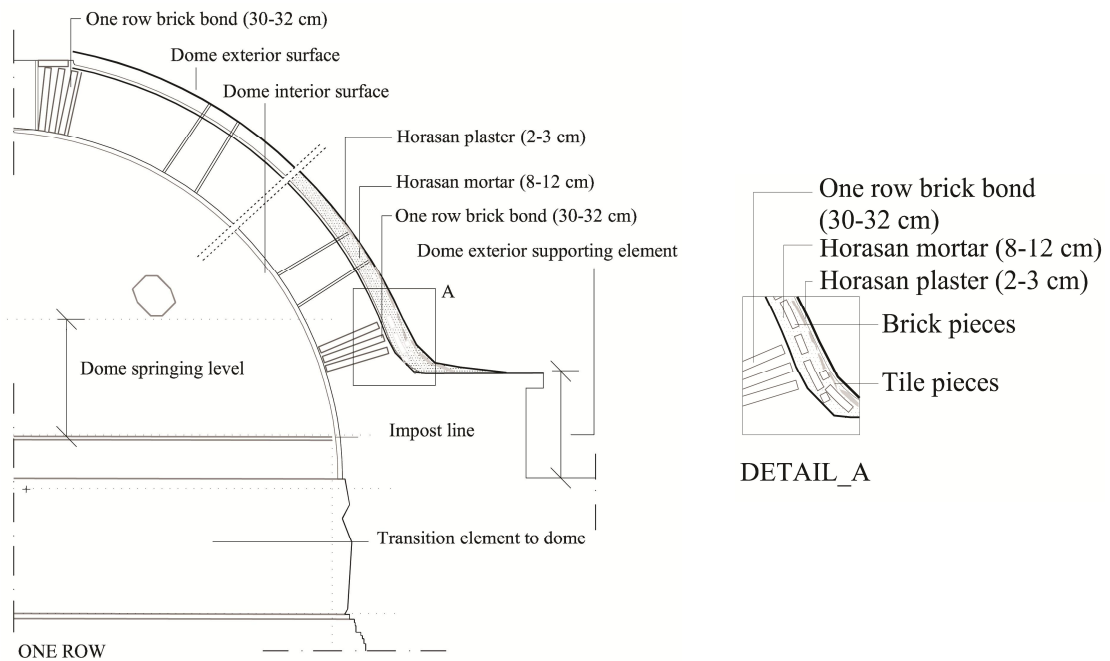

Figure 3.18. Thick plaster over one row brick in dome thickness.

Dome thickness are; minimum 35 to 40 centimeters, maximum 65 to 75 centimeters at the springing level according to the formation of the bond by being one or double brick; at the dome peak between 35 and 40 centimeters. Hence, the thickness

at the springing level is minimum 35 to 40 centimeters; 45 to 50 centimeters generally in the one row brick bond types whereas in use of double brick it is 65 to 75 centimeters at the springing level, 50 to 60 centimeters upwards, 35 to 40 centimeters at the dome peak.

All short-span domes and majority of mid-span domes have one row brick bond; of mid-span domes Tire Karagazi Hamamı men's and women's sections, Tire Hekim Hamamı, Urla Hersekzade Ahmet Paşa Hamamı men's and women's sections, and Tire Yalınayak Hamamı domes have double row brick bond; and long-span domes have double row at the springing level and one row at the dome peak crossing over the brick bond. Therefore, thickness in short-span domes is generally 35 to 64 centimeters at the springing levels, 35 to 40 centimeters at the peak point; in mid-span domes the values are between 45 and 65 centimeters at the springing level and 35 to 40 centimeters at the dome peak; finally in long-span domes thicknesses are 60 to 76 centimeters at the springing level and 35 to 40 centimeters at the peak. In most of the domes, it is observed that the thickness is between 35 and 40 centimeters, without being dependent on the bond type. It is possible to assert that on dome peaks the thickness originates from one row brick bond. However, it is found out that the two *halvet* domes of the Urla Hersekzade Ahmet Paşa Hamamı women's section are formed of double row brick from the springing level up to the dome peak and the thickness is 60 centimeters.

Therefore, as the dome thicknesses vary between 35 and 75 centimeters according to the dome span at the springing level and the mounting of the dome either directly on the wall or on a drum, they have a consistent thickness at the dome peak, between 35 and 40 centimeters. Consequently, in examining the relationship between the span and thickness, dome thickness at the springing level has been taken as a reference.

The graph in Figure 3.19 shows that there is a linear relation between the span and thickness of the examined domes. As the span increases, the thickness increases linearly. Thus, in the short and mid-span domes with a span up to 6 m, two different thickness ranges are measured as 35 to 45 and 46 to 72 centimeters. Thirty-six of these domes have thicknesses between 35 and 45 centimeters, thirty of them have a thickness between 46 and 72 centimeters. In case of being dome thicknesses between 35 and 45 centimeters, there are two different applications; either one row brick bond or one row brick bond with over a 10 to 15 centimeters thick horasan plaster layer composed of large and small brick, stone and tile pieces. In cases where dome thickness vary

between 46 and 72 centimeters, there is either thick horasan plaster coating (10 to 15 centimeters) on one row brick section or double row brick bond. In all long-span *soyunmalık* domes and long-span Tire Yalınayak Hamamı *sıcaklık* main space, the thickness is between 60 and 76 centimeters at the springing level. As a result, it is determined that double row brick bond was used in all of the seven long-span domes in the examined baths.

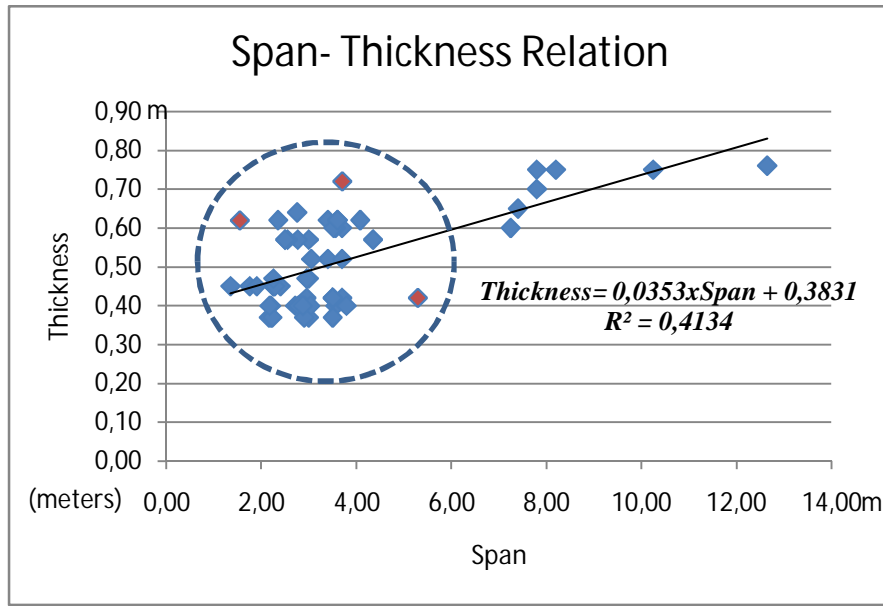

Figure 3.19. The relationship between span and thickness in all examined domes.

The domes, which deviate from this linear span and thickness relation, are Tire Tahtakale Hamamı *aralık* space dome (span: 1.55 m; thickness: 0.62 m), Tire Hekim Hamamı men's section *halvet* dome (span: 3.70 m; thickness: 0.72 m), and Urla Rüstem Paşa Hamamı *sıcaklık* main space dome (span: 5.30 m; thickness: 0.42 m). Although the spans are less in Tire Tahtakale Hamamı and Hekim Hamamı, thickness is larger; in addition, in Urla Rüstem Paşa Hamamı the span is large but the dome thickness is less in comparison to other examples. In Tire Tahtakale and Tire Hekim Hamamı domes, the reason may be the result of the application of 2 to 3 centimeters horasan plaster over the one row brick bond and an additional horasan coating on top, with a 10 to 15 cm thick, composed of brick, stone and roof tile crumbs and pieces. In Urla Rüstem Paşa Hamamı the thickness is less in comparison to the span. In this example although the span is

large, the thickness was created by one row brick bond and coated with 3-5 cm thick horasan plaster externally.

The result of the statistical analysis for the common span and thickness relation is presented in Figure 3.20, by excluding the three residual dome examples, which do not correspond to the linear relationship of span and thickness, from the model. Hence domes with short and mid-span, which are from 1.00 to 4.50 meters, have the thickness that varies between 35 to 65 centimeters. In the dome constructions that have these thicknesses, one row, double row or one row with thick plaster coating (10-15 cm) was applied. In the domes whose span is above seven meters, at the springing level there is double row brick and the thickness are between 60 and 75 centimeters.

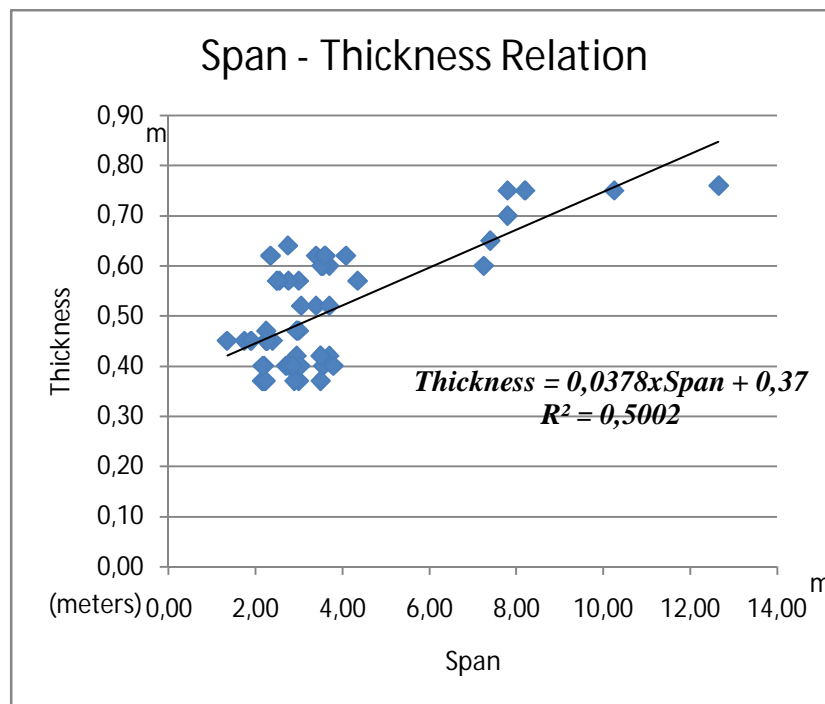

Figure 3.20. The common relationship between span and thickness in the examined domes.

The domes were bonded over a thick drum in a style that while more than one brick in the bond of the springing level in thickness were used, the bond was tapered towards the top and becomes one brick in thickness. This feature dealt with construction techniques of domes applied as from Romans in all dome constructions of Byzantine, Anatolian Seljuks and Principalities (Kolay 1999) was also continued in the examined domes of the Ottoman baths.

The double-layered cover that has a dome form interior and conical form exterior, and that fits on the high drum was a broadly applied cover-type in the Middle-ages of Persia and Anatolia. In the Byzantine period, in some buildings in various regions, it is recognized that the dome is covered with a low conical cover. However, this cover is one-layer on the contrary of the examples in Persia, South Caucaus and Anatolia (Kolay 1999, p.89), but, in the examined domes was not applied. it can be just seen that the coating over dome construction is 10-15 centimeters in thickness for the purpose of installation of spatial components as the second layer of domes exterior.

In Fontana's works (1694) on domes, there are important determinations and suggestions. These are the subjects concerning the relationship between spans and heights of domes and suggestions for the structural problems at the springing level. The proportional condition that should be provided in the relationship between span and thickness is 1:12. It should be 1:12 in springing level, and 1:18 in the top. In order to decrease the number of the existent structural problems in domes, Fontana also suggested in his works important precautions like reducing the weight of the lantern in the middle of the dome, adding exterior support-elements to thicken the springing level, or fortifying the main dome by a secondary dome ( Lopez Manzanares 2003).

In the examined domes, it was found that the relationship between span and thickness is close to the determined proportion.

### **3.4. Examination of the Bond Type in Domes**

The bond types used in the examined bath domes are; brick bond, brick / stone bond and stone bond. The bond type could be determined in fifty-nine of the seventy-nine examined domes. The domes which cannot be examined in terms of bond type have coating of horasan plaster both externally and internally. Majority of the domes were constructed using brick and lime plaster as adhesive. In Urla Hersekzade Ahmet Paşa Hamamı men's section, *ılıklik* and northwest *halvet* domes were constructed with brick/stone bond while *sıcaklık* main space, southwest, southeast *halvet* domes were constructed with stone bond, all these examples are all exceptional. All examined domes were coated with horasan plaster externally and internally.

### 3.4.1. Examination of the Brick Bond Types

In the brick bonds, both entire bricks and half bricks were used. Entire bricks have approximately 39-40 x 27-28 x 4-4.5 cm and 30-32 x 21-24 x 3-4.5 cm dimensions while half bricks have 21-24 x 14-16 x 3-4.5 cm dimensions. Both horizontal and vertical joints are 1.5 to 2.5 centimeters in width in interior surfaces, 3.0 to 5.0 centimeters in width in exterior surfaces.

The brick bonds expose five different layouts as regular circular rows (Figure 3.21). These are;

- a. Horizontal stacking of the short side faces in places non-parallel rows (39 domes), (Figure 3.21a),
- b. Horizontal and adjacent stacking of the short side faces in parallel rows (14 domes), (Figure 3.21b),
- c. Horizontal stacking of long faces on the bottom for a few rows and short faces on top in parallel rows (3 domes), (Figure 3.21c),
- d. Random horizontal stacking of long and short faces (3 domes), (Figure 3.21d),
- e. In vertical sequential stacking of long/short faces on interior, horizontal stacking of the long faces on exterior surface (3 domes), (Figure 3.21e).

The bond type, horizontal stacking of the short side faces in places non-parallel rows, is observed as the most common application in thirty-nine domes and another bond type, horizontal and adjacent stacking of the short side faces in parallel rows, is observed as secondary in fourteen domes. Apart from these two common types, the other types are determined only in three domes each.

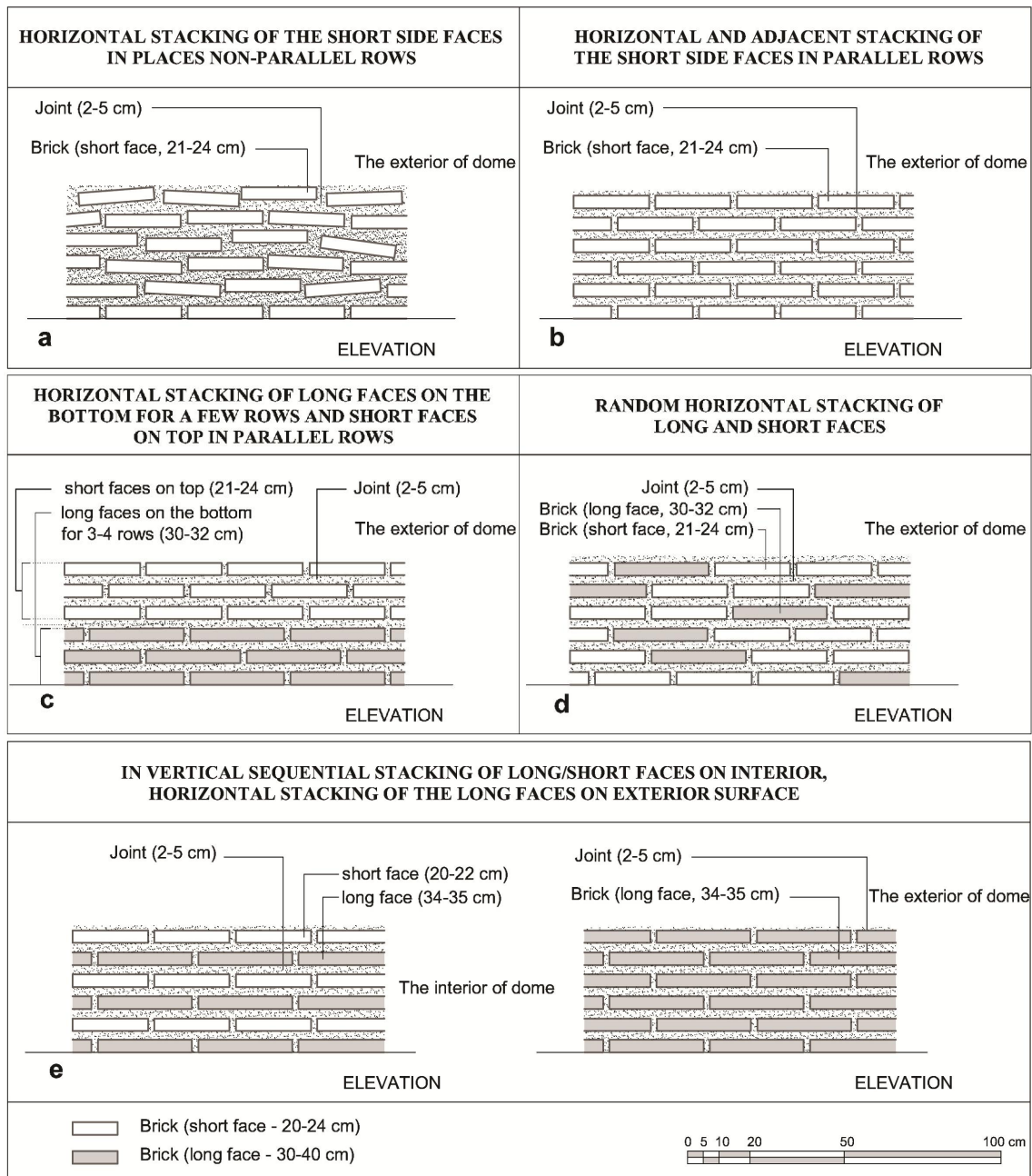

Figure 3.21. Brick bond types in regular circular rows in the examined domes.

### 3.4.1.1. Horizontal Stacking of the Short Side Faces in Places Non-Parallel Rows

This bond type was constructed with the principle of non-parallel placement of the bricks in places with their short sides facing both inside and outside, with radial axes towards the center (Figure 3.22). In this bond type, joints have different thicknesses and stacking is non-parallel in some parts. Uniform circular rows were created due to



application of different joint thicknesses that vary between 1.5 and 5.0 centimeters. Both complete and half bricks with different dimensions were used in this bond type. On the interior surface, the dome was coated with 1.0 to 1.5 centimeters thick single layer horasan plaster mixed with brick dust while on the exterior surface two layers of horasan plaster was applied, with a total thickness varying between 3.0 and 5.0 centimeters, which are a layer mixed with brick pieces with a thickness of 2.0 to 4.0 centimeters and another layer mixed with brick dust with 1.0 to 1.5 centimeters in thickness. The dome thickness is around two brick thick at the springing, approximately 65 to 75 centimeters, upwards from this level, the dimensions are around one and a half brick thick, approximately 50 to 60 centimeters, and at the dome peak the thickness is the dimensions of a single brick, around 35 to 40 centimeters (Figure 3.23).



Figure 3.22. In Urla Kamanlı Hamamı southwest *halvet* domes using the bond type of “horizontal stacking of the short side faces in places non-parallel rows”.

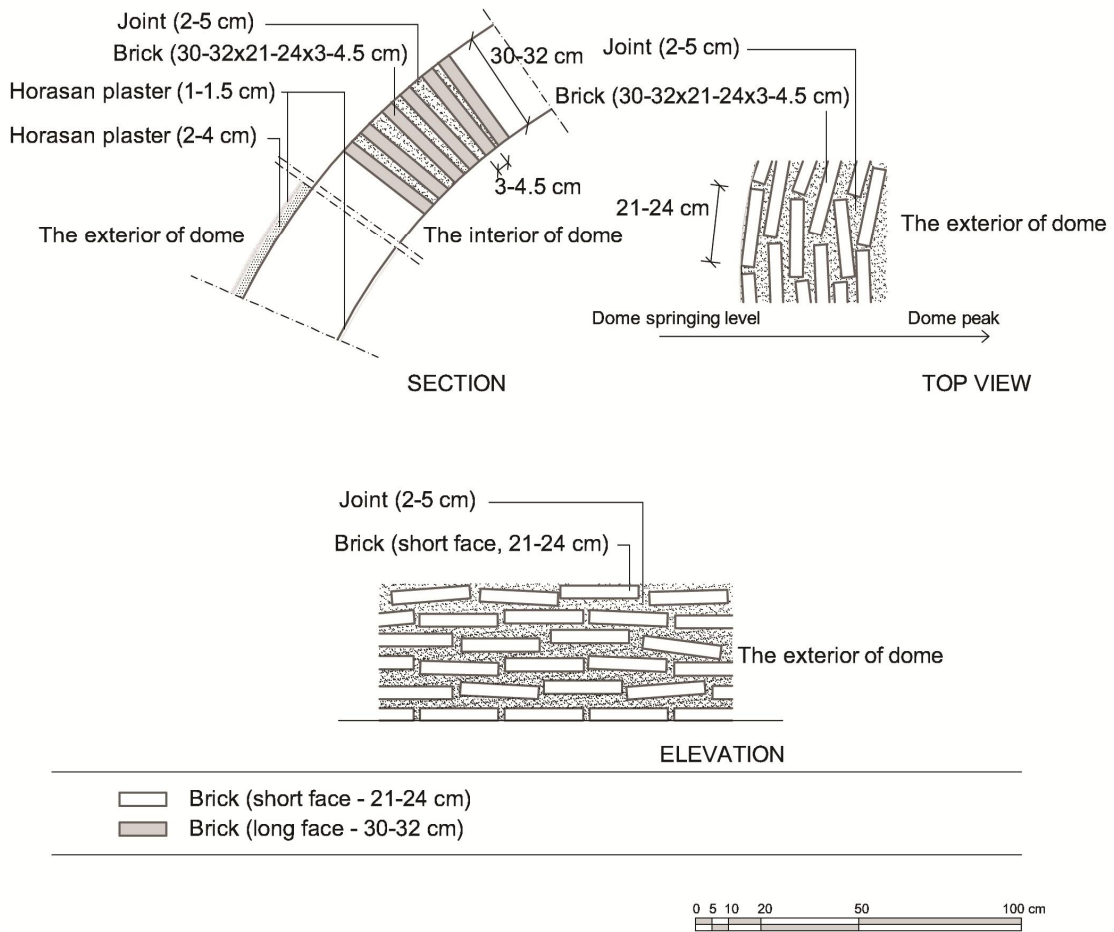

Figure 3.23. Drawings of the bond type of “horizontal stacking of the short side faces in places non-parallel rows”.

### 3.4.1.2. Horizontal and Adjacent Stacking of the Short Side Faces in Parallel Rows

This type of bond was constructed with the principle of radial and adjacent stacking of bricks, with their short sides facing both exterior and interior of the dome (Figure 3.24). Due to shift of half brick dimension for each radial placed brick rows on top of each other, joints that continue along the curvature of the domes could be applied alternately. On the interior surface of the dome, among both horizontal and vertical courses thin joints were applied whereas on the exterior surface wide joints for horizontal courses but thin joints for vertical courses were arranged. For long-span *soyunmalık* domes (spans longer than 6 meters), in which this type of bond can be observed, double brick rows were applied at the springing level and one brick row at the upper levels. The dome thickness is around 60 to 70 centimeters, double row brick

dimension, at the springing level and 30 to 35 centimeters at the dome peak level. In short-span *ıkklık*, *sıcaklık* main space and *halvet* domes (0.95 to 3.45 meters) the dome thickness was formed by one row brick. The interior surfaces were coated with single layer of 1.0 to 1.5 centimeters thick horasan plaster mixed with brick dust, the exterior surface were coated with two layers of 5.0 to 7.5 centimeters thick horasan plaster composed of a layer of 4.0 to 6.0 centimeters mixed with small and large brick pieces and another layer of 1.0 to 1.5 centimeters mixed with brick dust (Figure 3.25).

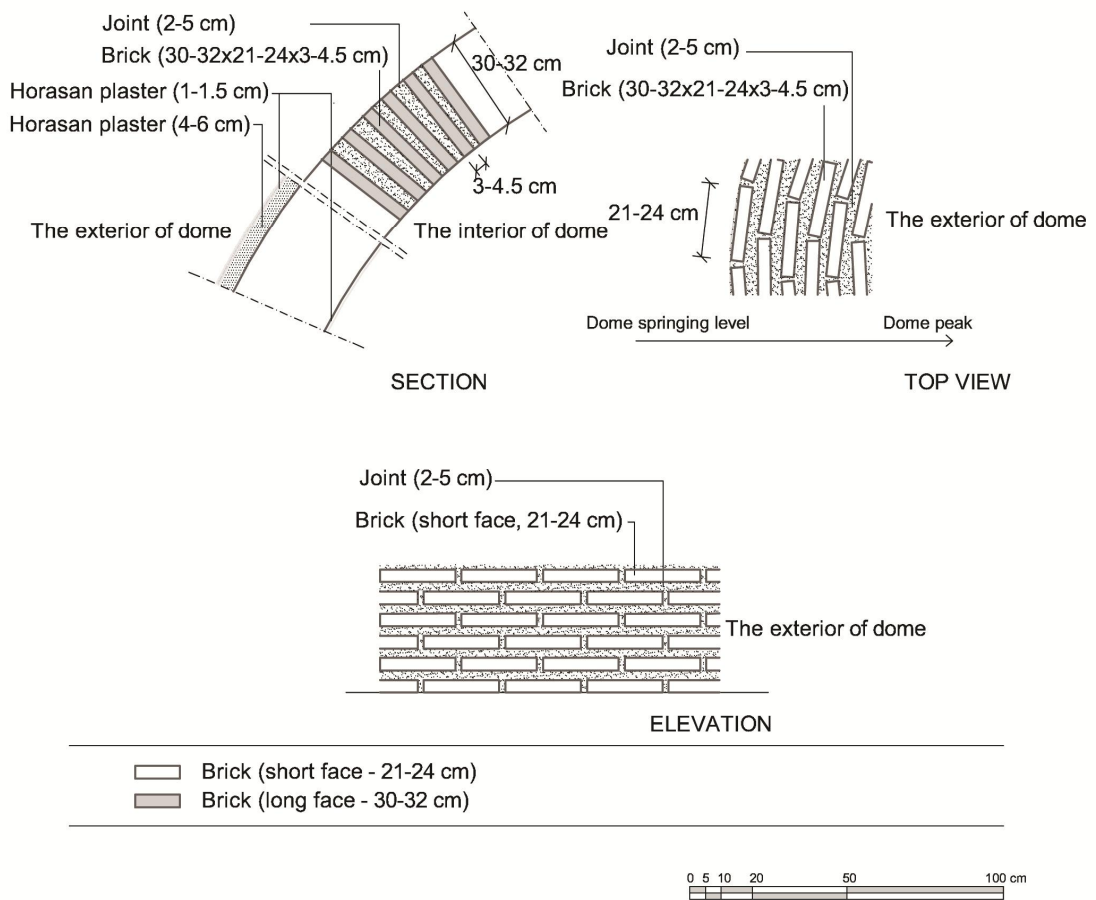

Figure 3.24. Drawings of the bond type of “horizontal and adjacent stacking of the short side faces in parallel rows”.



Figure 3.25. In Düzce (Hereke) Hamamı *soyunmalık* dome using the bond type of “horizontal and adjacent stacking of the short side faces in parallel rows”.

### 3.4.1.3. Horizontal Stacking of Long Faces on the Bottom for a few Rows and Short Faces on Top in Parallel Rows

The third type of bonds are constructed with the principles that long faces of bricks were stacked adjacently in three to four rows at the springing and above this level adjacent placement of short faces of the bricks and shifting of each row in half-brick dimension with radial axes towards the center (Figure 3.26). In this bond type; the long faces of double bricks were placed horizontally for three to four rows at the springing level, over these rows, one row bricks were used horizontally with their short faces along the dome surface. The dome was coated; inside with a single layer horasan plaster formed of 1.0 to 1.5 centimeters in thickness of brick dust mixture and outside with two layers of 3.0 to 5.0 centimeters in thickness of horasan plaster which was composed of 2.0 to 4.0 centimeters in thickness of layer mixed with brick pieces and 1.0 to 1.5 centimeters in thickness thin layer with brick dust mixture. The dome thickness is around 48 to 60 centimeters with double row brick dimensioned by short faces of the bricks at the springing whereas 35 to 40 centimeters in thickness at the dome peak level, due to use of one row brick and plaster together. The bond type can be observed in long-span *sıcaklık* main space dome (Figure 3.27).

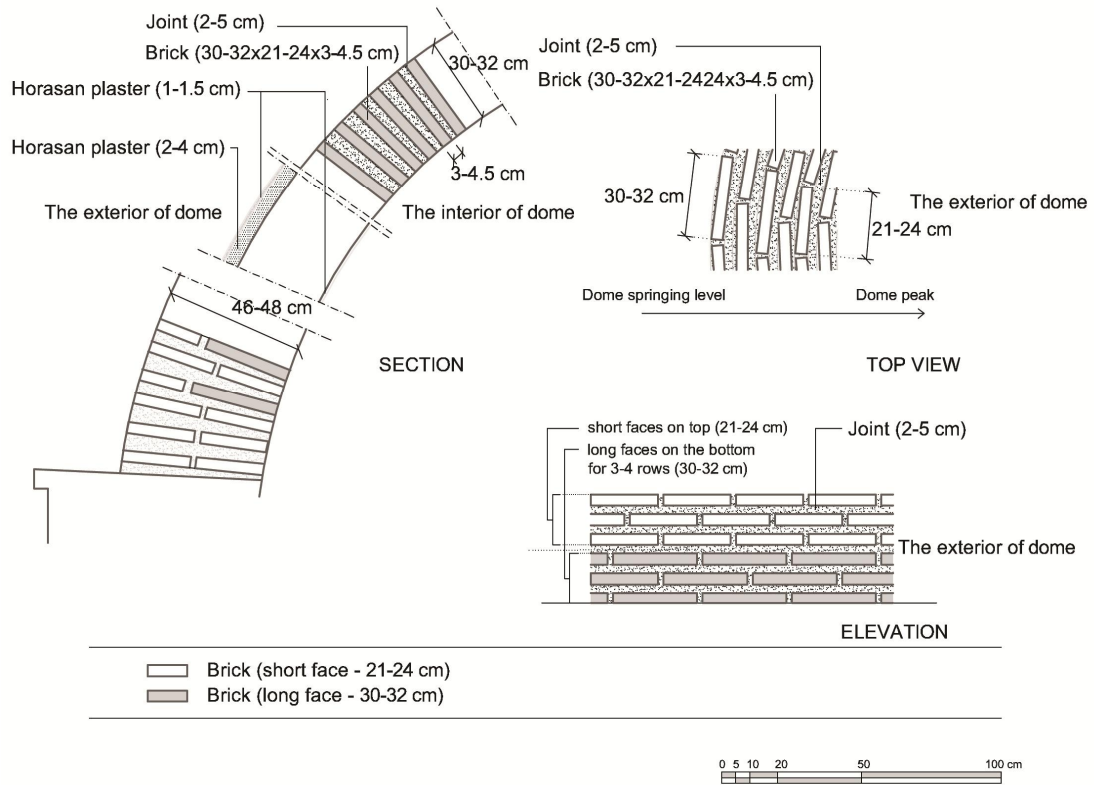

Figure 3.26. Drawings of the bond type of “horizontal stacking of long faces on the bottom for a few rows and short faces on top in parallel rows”.



Figure 3.27. In Tire Yalınayak Hamamı men's section sıcaklık main space dome using the bond type of “horizontal stacking of long faces on the bottom for a few rows and short faces on top in parallel rows”.

#### **3.4.1.4. Random Horizontal Stacking of Long and Short Faces**

In this type, the bond was constructed with random and radial stacking of long and short faces of the bricks adjacently aligned towards the dome center on horizontal plane (Figure 3.28). The piled bricks do not form regular horizontal rows, hence the mortar created the joints between the bricks, which have different thicknesses varying between 1.5 and 5.0 centimeters provide the integrity of the bond. Joint thicknesses are irregular due to the random stacking of bricks and around 1.5 to 2.5 centimeters in some parts, while in other parts wider almost close to brick thickness, approximately 3.5 to 5.0 centimeters. Besides the random stack of bricks, the brick rows were constructed by shifting each row with a half-brick dimension, and thus alternating joints were obtained. In addition, full and half bricks were used together in some parts of the bond (Figure 3.29). Common with previous examples, the dome surfaces were coated; inside with a single layer of horasan plaster formed of 1.0 to 1.5 centimeters in thickness with brick dust mixture and outside with two layers of 3.0 to 5.0 centimeters in thickness of horasan plaster composed of 2.0 to 4.0 centimeters in thickness of layer mixed with large and small brick pieces and 1.0 to 1.5 centimeters in thickness of layer with brick dust mixture. While the dome thickness at springing level is approximately 48 to 60 centimeters, with the use of short faces of two bricks or long face of one and a half brick with 3 to 5 centimeters thick horasan plaster, above springing level the thickness is around 35 to 40 centimeters due to use of long face of a one brick or short face of a one brick and half brick with 3 to 5 centimeters.

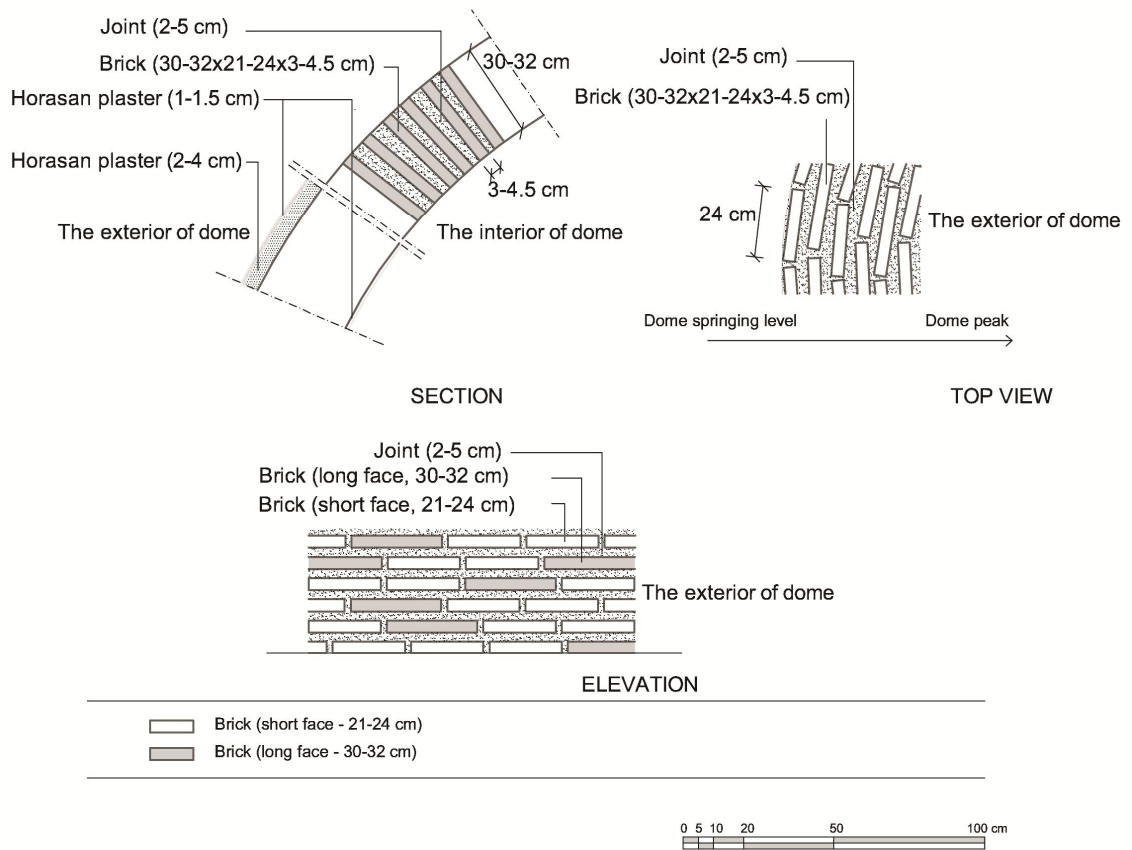

Figure 3.28. Drawings of the bond type of “*random horizontal stacking of long and short faces*”.



Figure 3.29. In Tire Tahtakale Hamami men’s section northeast *halvet* dome using the bond type of “*random horizontal stacking of long and short faces*”.

#### **3.4.1.5. In Vertical Sequential Stacking of Long/Short Faces on Interior, Horizontal Stacking of the Long Faces on Exterior Surface**

This type of bond was constructed with radial and adjacent stacking of the bricks towards the dome center, with shifting rows alternatively by one row with long faces and one row with short faces, along the surface of the dome (Figure 3.30). In these bonds, the joints were created alternatively and curvilinear in form along the dome by horizontally shifted brick rows that are radially stacked over each other by quarter or half brick size. Horizontal and curvilinear joints, form adjacent joints (2.0 to 2.5 centimeters) on the interior surfaces (2.0 to 2.5 cm) and wider joints (3.0 to 4.5 cm) on the exterior surfaces of the dome. As usual in all domes, dome surfaces were coated with; inside with a single layer horasan plaster formed of 1.0 to 1.5 centimeters in thickness with brick dust mixture and outside with two layers of 3.5 to 7.0 centimeters in thickness of horasan plaster composed of 2.5 to 5.0 centimeters thick layer mixed with large and small brick pieces and 1.0 to 1.5 centimeters thick layer with brick dust mixture (Figure 3.31). The dome thickness at the springing level is about two brick short face size of two bricks or one brick long face size of a one brick and short face size of a half brick and 3.0 to 5.0 centimeters of horasan plaster, in total approximately 52 centimeters.



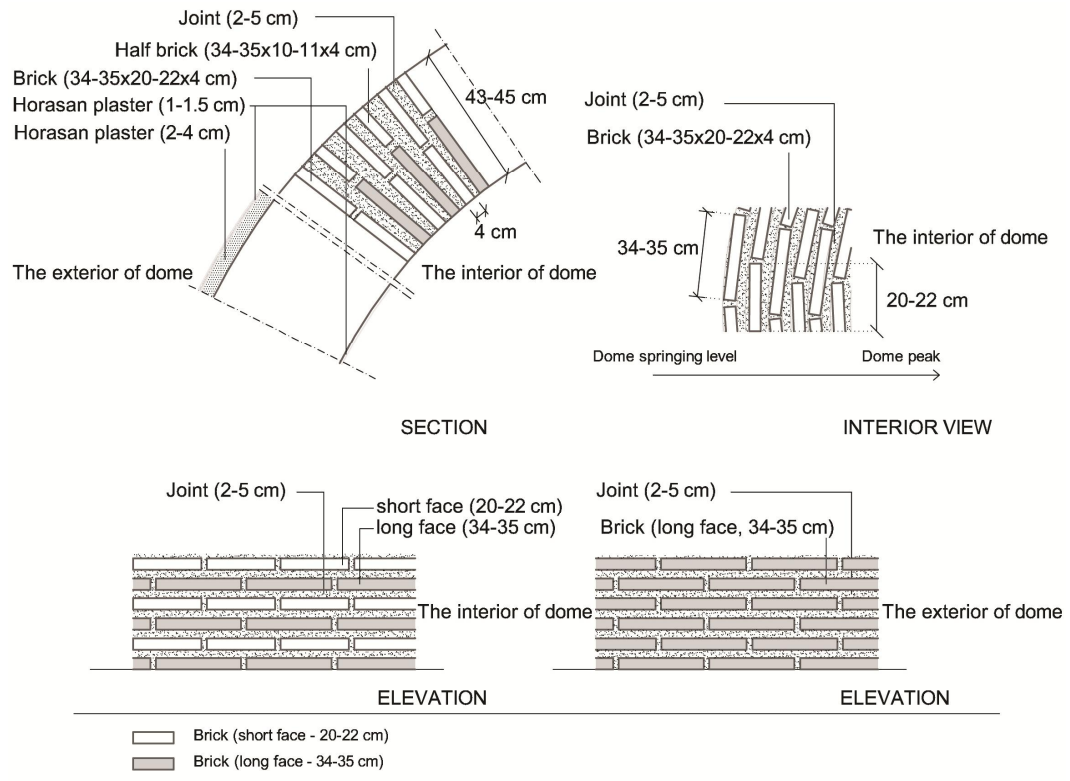

Figure 3.30. Drawings of the bond type of “in vertical sequential stacking of long/short faces on interior, horizontal stacking of the long faces on exterior surface”.



Figure 3.31. In Tire Karagazi Hamamı men’s section sıcaklık main space dome using the bond type of “in vertical sequential stacking of long/short faces on interior, horizontal stacking of the long faces on exterior surface”.

This bond type is sampled in all domes of Karagazi Hamamı. In this bond, the dome thickness is; the total of short faces of the adjacently placed two rows of bricks when they were used with long sides facing the interior surface of the dome, and half of the total of long faces and short faces used as the short sides facing the interior surface of the dome. In case that the long side of the brick face the interior surface of the dome, the short faces of adjacently placed two full bricks form the thickness. In case that the short side of the brick face the interior surface of the dome, one full brick was used on the direction facing the interior surface of the dome and half (31x12x3-5 cm) brick was used on the exterior surfaces of the dome as the long side of the brick face the exterior surface dome. The bricks were piled as; adjacent and thin bed joints, with wide joints on the surfaces going along the dome curve, forming a straight angle towards the dome center, radiant in horizontal plane. While it is being observed that on the interior surfaces of the dome, the adjacent piling of the long faces and short faces of the bricks alternatively were utilized along the bond on the horizontal direction, on the exterior surfaces the adjacent piling of merely the long faces of the bricks was fronted.

### **3.4.2. Examination of the Brick / Stone and Stone Bond Types**

Within the examined domes, apart from the brick bonds, two more bond types, irregular brick/stone bond and irregular stone bond were determined. Urla Hersekzade Ahmet Paşa Hamamı men's section *ılıklik* dome and northwest *halvet* dome are the two domes where the irregular brick/stone bond was observed, men's section *sıcaklık* main space and south *halvet* domes of the same bath are the three domes where irregular stone bond was observed.

#### **3.4.2.1. Irregular Brick/Stone Bond Formed by Stacking of Brick and Cut Stone in Random Rows**

The bonds were formed by radiant stacking of the short faces of the bricks and cut stones in horizontal plane, overlapping and in disordered rows when the dome curves (Figure 3.32). In this bond, the joints became staggered on the dome curve formed by horizontal sliding of the radiant piled bricks overlapping towards the dome

center and in some places cut stone one over the other at half brick size. The dimensions of the bricks and cut stones in the bond are very close to each other and thus no big differences can be observed. The dome thicknesses are; approximately 65-70 cm in total of the two brick short sides at the springing level with the binding mortar, one short side of whole brick, approximately 45-50 cm at the dome peak. Towards the dome peak, half brick or large brick pieces and thin sectioned cut stone usage is observed. The joint thicknesses formed horizontal and along the dome curve, expose varying differences for being an irregular bond. In some places 1-1.5 cm thick thin joints, in some places 3-5 cm thick wide joints were formed. This bond type was used only in Urla Hersekzade Ahmet Paşa Hamamı men's section *ılıkık* dome and in northwest *halvet* dome (Figure 3.33).

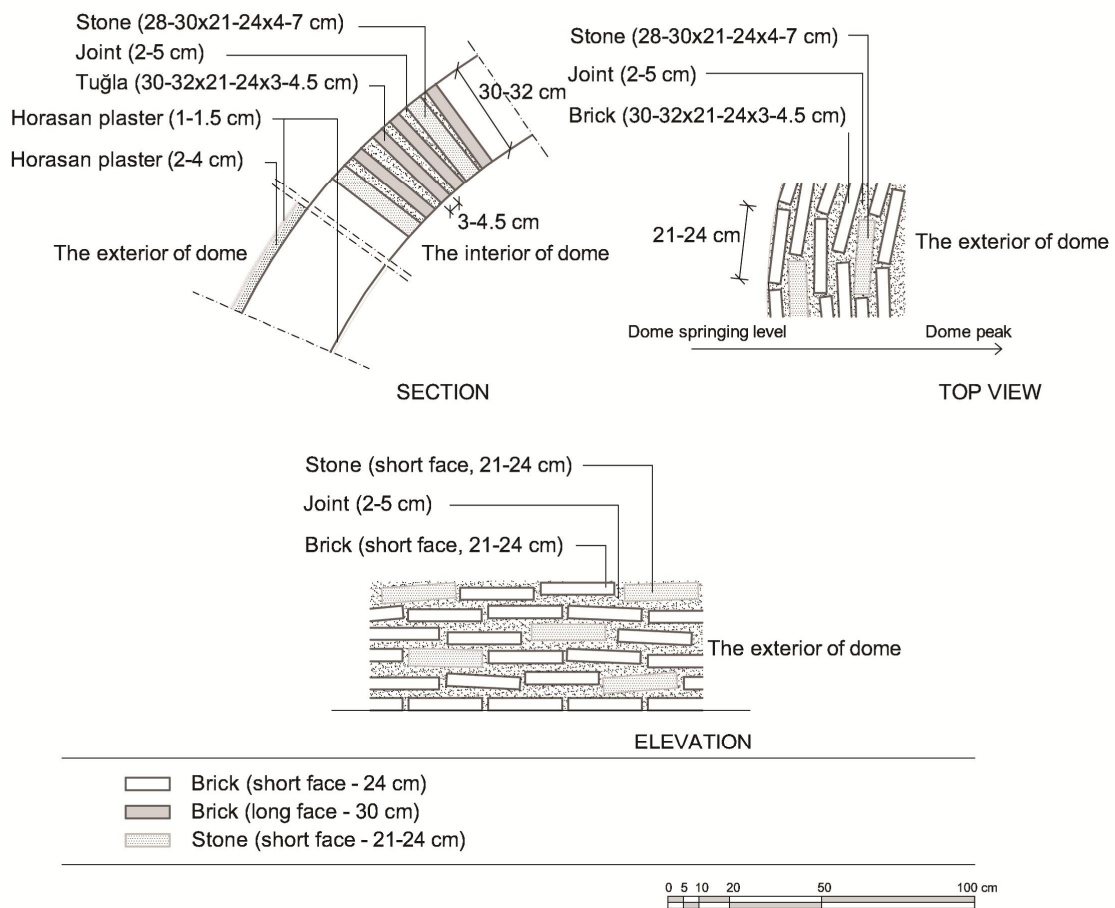

Figure 3.32. Drawings of the irregular brick/stone bond type of “irregular brick/stone bond formed by stacking of brick and cut stone in random rows”.



Figure 3.33. In the dome of Urla Hersekzade Ahmet Paşa Hamamı men's section *ılıklik* space using the irregular brick / stone bond.

#### **3.4.2.2. Irregular Stone Bond Formed by Random and Irregular Stacking of Rubble and Cut Stone**

These bonds were formed by irregular and radiant stacking of stones with their short faces placed adjacently in horizontal plane and overlapping along the dome curve (Figure 3.34). In this bond, the joints on the dome curve became staggered due to shifting rubble stone that were overlapped and stacked radiantly and in some parts cut stone is shifted one over another without any order approximately by half brick size. The dimensions of the rubble stone and the cut stone in the bond are close to each other and no big differences can be observed. The dome thicknesses are; approximately 65 to 70 centimeters at the springing level together with the binding mortar and coating plaster, approximately 45 to 50 centimeters at the dome peak. Towards the dome peak, half rubble stone or large stone pieces with thin sectioned cut stone usage is observed. The joint thicknesses formed horizontally and along the dome curve, vary between 1.0 and 5.0 centimeters as a result of irregular bonding. In some places, 1.0 to 2.5 centimeters thick thin bed joints and in some places 3.0 to 5.0 centimeters thick wide joints were formed. This bond was used only in Urla Hersekzade Ahmet Paşa Hamamı men's section *sıcaklık* main space and in two *halvet* domes in south direction (Figure 3.35).

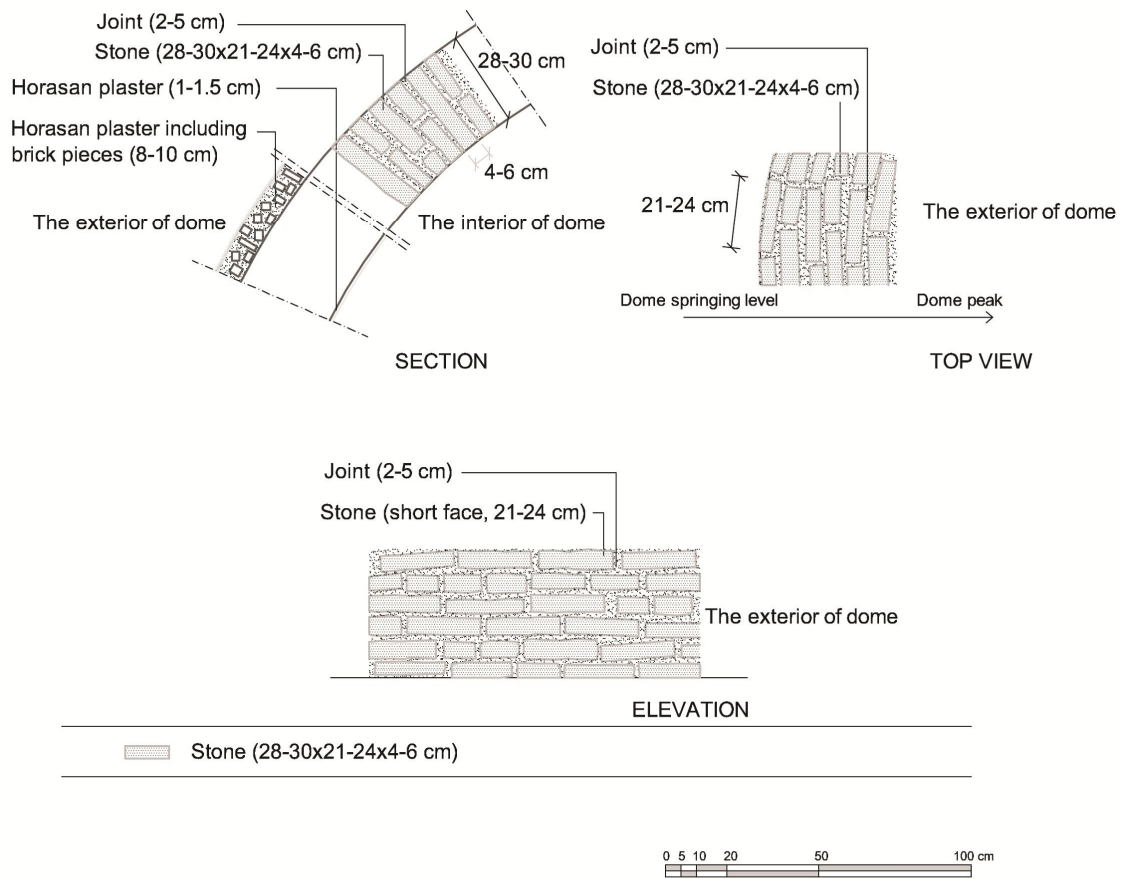

Figure 3.34. Drawings of the irregular stone bond type of “*irregular stone bond formed by random and irregular stacking of rubble and cut stone*”.



Figure 3.35. A part of collapsed dome in Urla Hersekzade Ahmet Paşa Hamamı men’s section *sıcaklık* main space. “*irregular stone bond formed by random and irregular stacking of rubble and cut stone*” with horasan coating composed of large and small pieces of brick can be seen on the figure.

### 3.4.3. Distribution of Bond Types in Domes

The first group as “horizontal stacking of the short side faces in places non-parallel rows”, is the most common bond type with 39 domes. The second group brick bond type as “horizontal and adjacent stacking of the short side faces in parallel rows” is determined in 14 domes. The distribution of all bond types in percentages is; “horizontal stacking of the short side faces in places non-parallel rows” type brick bonds have 66.1%, “horizontal and adjacent stacking of the short side faces in parallel rows” type brick bonds have 23.7% and “horizontal stacking of long faces on the bottom for a few rows and short faces on top in parallel rows” and “random horizontal stacking of long and short faces” type brick bonds have 5.1% in total (Figure 3.36).

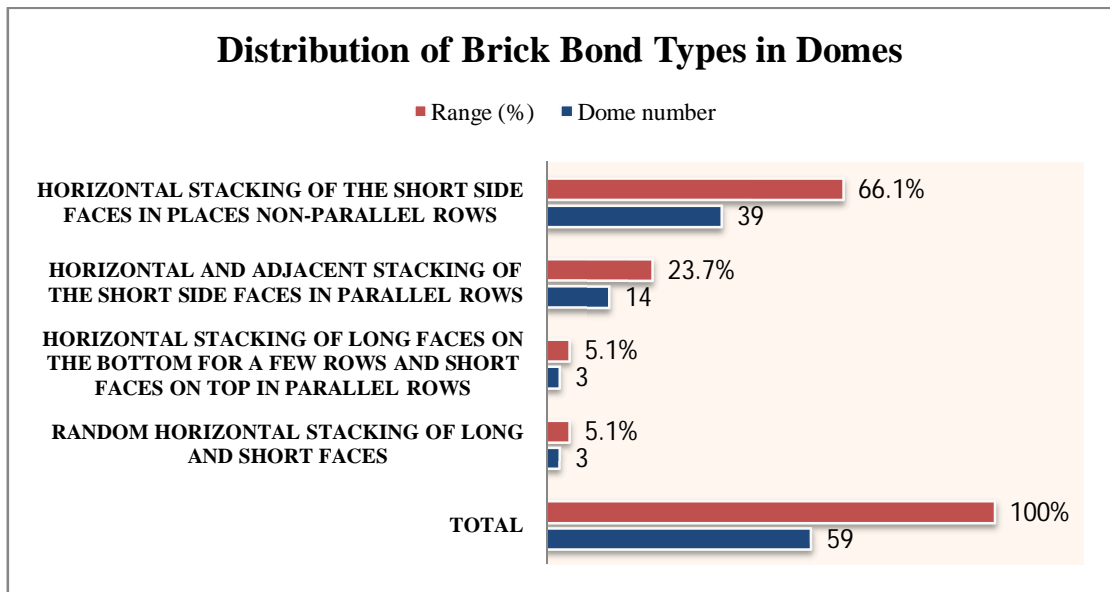

Figure 3.36. Distribution of brick bond types in domes.

Another brick bond type as “in vertical sequential stacking of long/short faces on interior, horizontal stacking of the long faces on exterior surface” is not included in examinations and evaluations, since it is a bond type which is sampled only in Tire Karagazi Hamamı domes. In addition to this, irregular brick/stone bond type where the brick and stone were used together and the irregular stone bond, which are merely observed in *sıcaklık* main space’s and south *halvets*’ domes of Urla Hersekzade Ahmet

Paşa Hamamı men’s section, are the particular examples that have not been evaluated. The distribution of brick bonds that are included in examinations and evaluations of the domes is shown in Table 3.24.

Table 3.24. Distribution of bond types in domes.

<b>Bond types</b>	<b>Dome number</b>	<b>Range (%)</b>
Horizontal Stacking of the Short Side Faces in Places Non-Parallel Rows	39	66.1%
Horizontal and Adjacent Stacking of the Short Side Faces in Parallel Rows	14	23.7%
Horizontal Stacking of Long Faces on the Bottom for a few Rows and Short Faces on Top in Parallel Rows	3	5.1%
Random Horizontal Stacking of Long and Short Faces	3	5.1%
<b>TOTAL</b>	<b>59</b>	<b>100%</b>

“Horizontal stacking of long faces on the bottom for a few rows and short faces on top in parallel rows” and the “random horizontal stacking of long and short faces” group bond types are sampled only in three domes, thus they are not included in examinations for bond type, span, and height relation. Data gathered from only three domes are insufficient in terms of statistical evaluation, thus excluded from the numerical results.

When the relationships between the bond types and dome span examined, within the determined bond types; “horizontal and adjacent stacking of the short side faces in parallel rows” bond type is majorly observed in long-span domes, “horizontal stacking of the short side faces in places non-parallel rows” and “horizontal stacking of long faces on the bottom for a few rows and short faces on top in parallel rows” bond type is detected mostly in mid-span domes, and finally “random horizontal stacking of long and short faces” bond type is mostly observed in short-span domes. However, generally in long and mid-span domes, the bond turns into “horizontal and adjacent stacking of the short side faces in parallel rows” bond type towards the dome peak.

In “horizontal stacking of the short side faces in places non-parallel rows”, in “horizontal and adjacent stacking of the short side faces in parallel rows” and in “horizontal stacking of long faces on the bottom for a few rows and short faces on top in parallel rows” bond types, the dome thickness were established generally through

double brick at the springing level, through one brick towards the dome peak and mostly by turning into “horizontal and adjacent stacking of the short side faces in parallel rows” bond type. In the domes with the “random horizontal stacking of long and short faces” bond type, the dome thickness was maintained mostly by one brick and without differentiating of bond type from the springing level up to the peak.

Dimensions of the domes that have bond types that have majority in number are represented in the tables below. The domes with “horizontal stacking of the short side faces in places non-parallel rows” bond type are shown in Table 3.25 while the domes with “horizontal and adjacent stacking of the short side faces in parallel rows” bond type are shown in Table 3.26.

Table 3.25. Domes constructed with the bond type of “horizontal stacking of the short side faces in places non-parallel rows”.

Baths	Space	Thickness (meters)	Height (meters)	Span (meters)	Bond T.
Urla Hersekzade Ahmet Paşa H.(W)	<i>ılıklik</i> main unit	0.45	0.75	2.25	1
Seferihisar Büyük H.	<i>ılıklik</i> main unit	0.45	0.80	1.75	1
Tire Hekim H.(W)	<i>ılıklik</i> main unit	0.57	1.10	2.76	1
Urla Hersekzade Ahmet Paşa H.(W)	<i>ılıklik</i> sub-unit	0.45	1.01	2.25	1
Seferihisar Büyük H.	<i>ılıklik</i> sub-unit	0.45	0.60	1.35	1
Tire Tahtakale H.	<i>ılıklik</i> sub-unit	0.62	0.81	2.35	1
Tire Hekim H.(W)	<i>ılıklik</i> sub-unit	0.64	0.91	2.75	1
Tire Yeniceköy H.	<i>ılıklik</i> sub-unit	0.40	0.94	2.20	1
Urla Özbek Köyü H.	<i>sıcaklık</i> main space	0.45	1.00	2.40	1
Seferihisar Büyük H.	<i>sıcaklık</i> main space	0.42	1.10	2.95	1
Seferihisar Küçük H.	<i>sıcaklık</i> main space	0.40	1.50	2.90	1
Sığacık Kaleiçi H.	<i>sıcaklık</i> main space	0.37	0.95	2.20	1
Düzce (Hereke) H.	<i>sıcaklık</i> main space	0.37	1.76	3.50	1
Ulaş H.	<i>sıcaklık</i> main space	0.40	1.26	2.71	1
Tire Hekim H.(M)	<i>sıcaklık</i> main space	0.52	1.51	3.05	1
Tire Hekim H.(W)	<i>sıcaklık</i> main space	0.52	1.44	3.70	1
Tire Yeniceköy H.	<i>sıcaklık</i> main space	0.42	1.46	3.70	1
Tire Şeyh H.	<i>sıcaklık</i> main space	0.37	1.18	3.00	1
Urla Hersekzade Ahmet Paşa H.(M)	<i>halvet</i>	0.47	1.50	3.00	1
<b>Urla Kamanlı H.</b>	<b><i>halvet</i></b>	<b>0.40</b>	<b>2.01</b>	<b>2.87</b>	<b>1</b>
Urla Özbek Köyü H.	<i>halvet</i>	0.45	0.87	2.28	1
Seferihisar Büyük H.	<i>halvet</i>	0.47	1.20	2.95	1
Seferihisar Küçük H.	<i>halvet</i>	0.40	1.80	3.79	1

(cont. on next page)



Table 3.25. (cont.)

Sığacık Kaleiçi H.	<i>halvet</i>	0.37	0.65	2.16	1
Ulamış H.	<i>halvet</i>	0.40	1.10	2.78	1
Tire Yeniceköy H.	<i>halvet</i>	0.42	1.57	3.50	1
<b>Tire Yalınayak H.(M)</b>	<b><i>halvet</i></b>	<b>0.57</b>	<b>1.46</b>	<b>4.35</b>	<b>1</b>
Urla Kamanlı H.	<i>halvet</i>	0.40	1.17	3.03	1
Urla Özbek Köyü H.	<i>halvet</i>	0.47	0.87	2.25	1
Seferihisar Büyük H.	<i>halvet</i>	0.47	1.15	2.95	1
Seferihisar Küçük H.	<i>halvet</i>	0.45	0.90	1.90	1
Sığacık Kaleiçi H.	<i>halvet</i>	0.37	0.70	2.23	1
Düzce (Hereke) H.	<i>halvet</i>	0.37	1.40	2.90	1
Ulamış H.	<i>halvet</i>	0.40	1.30	2.87	1
Tire Yeniceköy H.	<i>halvet</i>	0.42	1.35	3.50	1
<b>Tire Yalınayak H.(M)</b>	<b><i>halvet</i></b>	<b>0.57</b>	<b>0.58</b>	<b>2.50</b>	<b>1</b>
<b>Urla Kamanlı H.</b>	<b><i>halvet</i></b>	<b>0.40</b>	<b>1.50</b>	<b>2.17</b>	<b>1</b>
Tire Yalınayak H.(M)	<i>halvet</i>	0.57	0.76	2.55	1
Tire Yalınayak H.(M)	<i>halvet</i>	0.57	0.98	2.50	1

**Residual domes with different distributions from data of the common domes.**

Table 3.26. Domes constructed with the bond type of “horizontal and adjacent stacking of the short side faces in parallel rows”.

<b>Baths</b>	<b>Space</b>	<b>Thickness (meters)</b>	<b>Height (meters)</b>	<b>Span (meters)</b>	<b>Bond T.</b>
Seferihisar Büyük H.	<i>soyunmalık</i>	0.65	3.20	7.40	2
Düzce (Hereke) H.	<i>soyunmalık</i>	0.60	3.15	7.25	2
Tire Tahtakale H.	<i>soyunmalık</i>	0.76	4.93	12.65	2
Tire Yalınayak H.(M)	<i>soyunmalık</i>	0.75	3.57	8.20	2
Tire Yalınayak H.(W)	<i>soyunmalık</i>	0.70	3.20	7.80	2
Tire Eski-Yeni H.(M)	<i>soyunmalık</i>	0.75	5.10	10.25	2
Tire Tahtakale H.	<i>aralık</i>	0.62	1.10	1.55	2
Tire Hekim H.(M)	<i>ılıklik main unit</i>	0.52	1.49	3.40	2
Urla Hersekzade Ahmet Paşa H.(W)	<i>sıcaklık main space</i>	0.60	1.90	3.70	2
Urla Kamanlı H.	<i>sıcaklık main space</i>	0.40	1.10	3.56	2
<b>Urla Rüstem Paşa H.</b>	<b><i>sıcaklık main space</i></b>	<b>0.42</b>	<b>3.51</b>	<b>5.30</b>	<b>2</b>
Urla Hersekzade Ahmet Paşa H.(W)	<i>halvet</i>	0.60	1.64	3.56	2
Tire Hekim H.(M)	<i>halvet</i>	0.72	1.44	3.70	2
Urla Hersekzade Ahmet Paşa H.(W)	<i>halvet</i>	0.60	1.65	3.52	2

**Residual domes with different distribution of data from data of the common domes.**

### 3.4.4. Examination of the Span to Height Relation in the Domes with Common Bond Type

The span and height relation for each bond type in the domes with the brick bond types, the most common type “*horizontal stacking of the short side faces in places non-parallel rows*” is observed in 39 domes of the examined domes and “*horizontal and adjacent stacking of the short side faces in parallel rows*” is observed in 14 domes, and are presented below in section 3.4.4.1 and 3.4.4.2.

#### 3.4.4.1. Span to Height Relation in Horizontal Stacking of the Short Side Faces in Places Non-Parallel Rows Bond Type

The linear relationship between the span and height in the domes with the first bond group can be seen in the chart in Figure 3.37. Consequently, in approximately 1 meter span the height is 41 cm, in 10 m span the height is 4.1 m. Within this framework it can be proposed that the height-span ratio is 0.41.

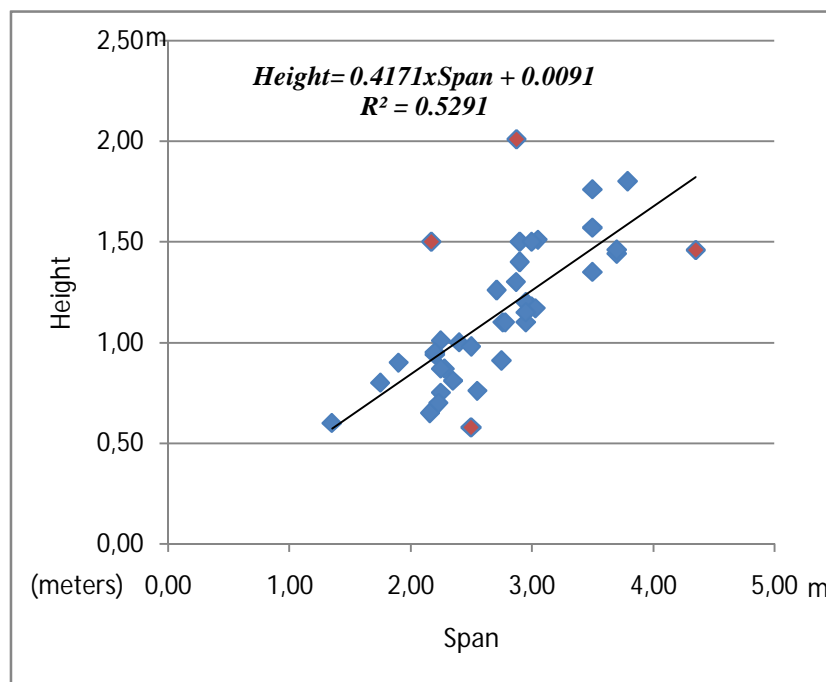

Figure 3.37. The relationship between span and height in all domes with the bond type of “*horizontal stacking of the short side faces in places non-parallel rows*”.

It is determined that the height-span ratio, which is determined as 0.42 in all domes, is 0.41 in domes with this bond and is very close to the ratio in all domes. Therefore, it can be proposed that the span-height relation in the domes within this bond group is the same as the span-height relation in all examined domes.

The four residual domes that do not depict a linear feature in span and height relation are; Tire Yalınayak Hamamı men’s section *halvet* domes (4.35:1.46 meters)-(2.50:0.58 meters), Urla Kamanlı Hamamı southwest *halvet* dome (2.17:1.50 meters) and northwest *halvet* dome (2.87:2.01 meters). In Tire Yalınayak Hamamı men’s section *halvet* domes (with spans of 4.35 and 2.50 meters), the heights are 1.46 and 0.58 meters instead of 1.78 and 1.02 meters respectively. In Urla Kamanlı Hamamı southwest and northwest *halvet* domes (with spans of 2.17 and 2.87 meters), the heights are 1.50 and 2.01 meters instead of 0.88 and 1.17 meters respectively.

In consequence of excluding these four residual domes of which the span-height relation do not present linear functions, the common span to height relation is shown in Figure 3.38. While in all domes with this bond type the ratio of height to the span is 0.41, it is 0.48 in common domes.

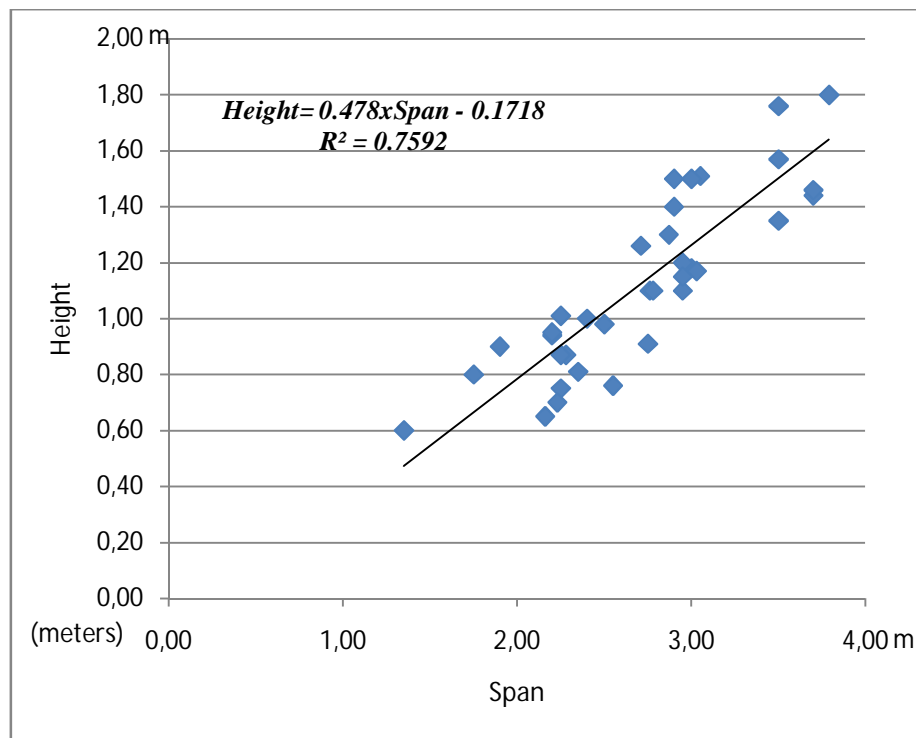

Figure 3.38. The relationship between span and height in common domes with the bond type of “horizontal stacking of the short side faces in places non-parallel rows”.

### 3.4.4.2. Span to Height Relation in Horizontal and Adjacent Stacking of the Short Side Faces in Parallel Rows Bond Type

The linear relation between the span and height in the domes with second bond group can be seen in Figure 3.39. As a result, in approximately 1.0 meter span the height is 40 centimeters and in 10 meters span the height is 4.0 meters. Within this framework it can be proposed that the height-span ratio is 0.4.

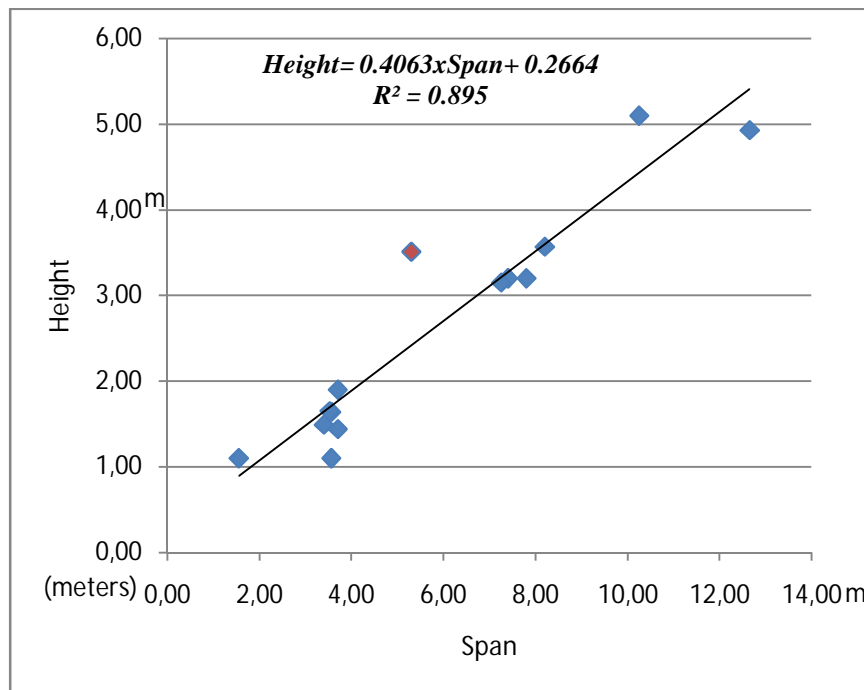

Figure 3.39. The relationship between span and height in all domes with the bond type of “horizontal and adjacent stacking of the short side faces in parallel rows”.

Regardless of the bond type, the ratio of the height to the span, which is determined as 0.42 due to data of all domes, is determined as 0.40 in the domes with this bond type thus the ratios are very close to “horizontal stacking of the short side faces in places non-parallel rows” bond type. Therefore, it is possible to assert that the span to height relation in the domes within this bond group is the same as the span-height relation determined by considering all domes.

Urla Rüstem Paşa Hamamı *sıcaklık* main space dome is the only dome which doesn't provide a linear feature in the span to height relation (5.30:3.51 meters). In this dome, although the height should be 2.12 meters in response to 5.30 meters span, the height is 3.51 meters. In this dome the impost line is on a higher elevation from the dome center. The height of impost line from the dome center line is an important criterion that determines the oblateness of the dome. When this dome, which does not expose a linear feature in the span-height relation, is excluded, the ratio of the height to the span in span-height relation merely changes. While the ratio of the height to the span is 0.40 in all domes, it is 0.41 in common domes. The common span to height relation in the domes with the “*horizontal and adjacent stacking of the short side faces in parallel rows*” bond type is given in Figure 3.40.

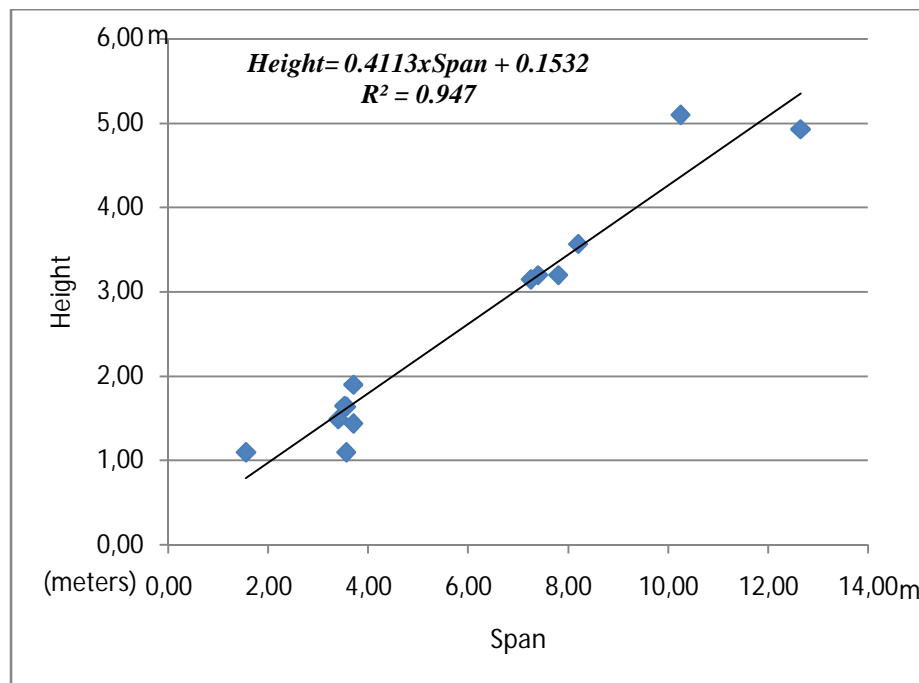

Figure 3.40. The relationship between span and height in common domes with the bond type of “*horizontal and adjacent stacking of the short side faces in parallel rows*”.

According to Ahunbay (1986), the bricks are aligned in a radial manner in domes (curvilinear covers), as they rise towards the top, to the level of the void for keystone. In case of the domes with pyramidal rise, the bricks were aligned as parallel

to the axis of each surface, and in a radial manner. The dome thicknesses change regarding the span of the covers (Ahunbay 1986, p.131). The situation stated by Ahunbay is also determined in the bonds defining the characteristics of construction technique in the bath-domes. That the construction techniques of the masonry constructions are similar in every region is important in respect of general characteristics of Ottoman buildings were maintained in the vernacular construction techniques, as well, in spite of the materialistic differences.

In two-thousand-year-period (27BC - 2000AD), when the evolution phases of the domes in different sizes (like the Pantheon, Hagia-Sophia, Florence Cathedral, Saint Peter's Cathedral, Saint Paul's Cathedral in London, Reichstag)—which differ because of the construction techniques, material usages, and structural characteristics—are examined with regard to their spans, heights, structural materials, construction dates, technologies, and structural characteristics, it may be claimed that the characteristics and capacity of the materials determine the construction technique and morphological features of the buildings (Altın 2001, pp. 197-208). This situation supports the relationship between the construction techniques and morphological features in the bath-domes. During the examinations on bath-domes, a linear relationship was determined between them.

### **3.5. Examination of the Lighting Elements Arranged in Domes**

In all bath structures, the relationship between light and space is established by lighting elements on the domes. The lighting elements arranged on the dome are oculi, light cupolas, top skylights, lighting lanterns and windows.

The presence of oculi on the curvilinear surfaces of the *ılıklik*, *sıcaklık* main space and *halvet* domes of the examined baths is a common characteristic. On the top of dome, in accordance with the scale of the dome either oculus or light cupola or top skylight is located.

The lighting elements arranged on the domes in baths are; oculi on the curvilinear surfaces of the *ılıklik* main space, *sıcaklık* main space, and *halvet* domes, and one of among oculi, light cupola or top skylight on the top of dome. The lighting elements in *soyunmalık* domes are, lighting lanterns located on the top of dome and the windows at the springing level.

Hence, the lighting elements are examined under two topics as oculi and lighting lantern.

### 3.5.1. Examination of Oculi in Domes

The layout of oculi in domes can be discussed in three groups:

- Oculi on whole dome surface,
- Light cupola on the top of dome, oculi on curved surfaces,
- Top skylight on the top of dome, oculi on curved surfaces.

#### 3.5.1.1. Oculi on Dome Surfaces

Oculi are the lighting elements provided on domes by placing terracotta pipes among the brick bond (Figure 3.41) or shaping the brick bond (Figure 3.42).

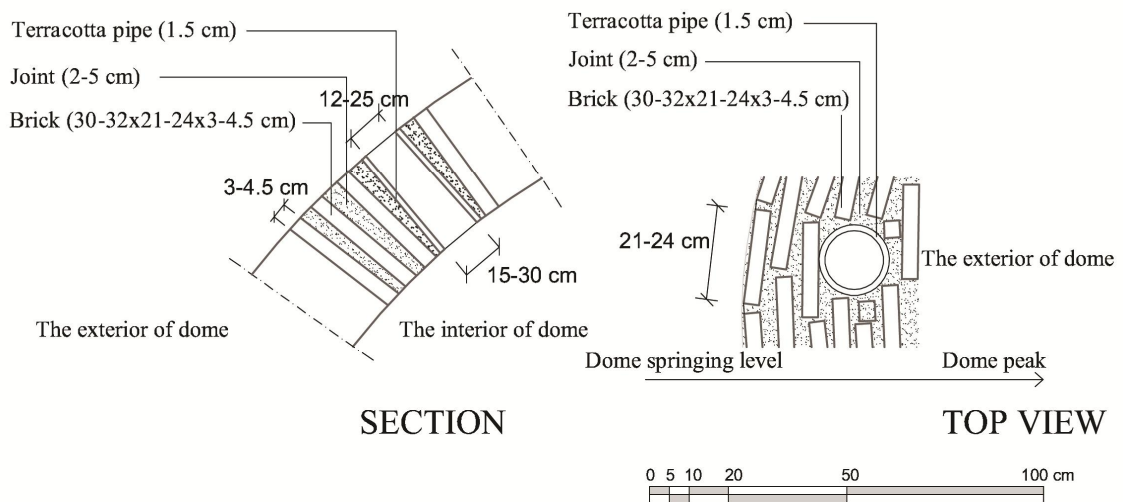

Figure 3.41. Oculus in the domes formed by placing terracotta pipes among brick bond.

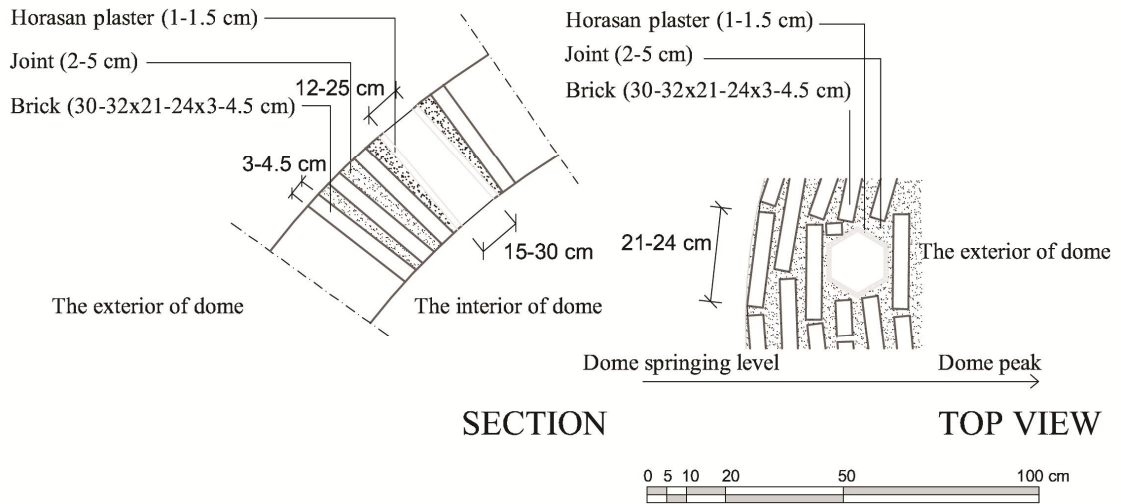

Figure 3.42. Oculus in the domes formed by shaping the brick bond.

In the long-span domes, the common width of the oculi span is 25 to 30 centimeters on the inside and 19 to 25 centimeters on the outside; in mid-span domes 20 to 24 centimeters on the inside, 15 to 19 centimeters on the outside; in short-span domes 15 to 19 centimeters on the inside, 12 to 15 centimeters on the outside; in decreasing sizes with narrowing between 3 to 5 centimeters from inside to outside. The width of oculi spans are commonly determined as consistent through the dome surface up to the top point. The circular oculi was formed through the terracotta pipes placed among the bond, on the other hand pentagonal, hexagonal or star shaped ones were formed through the openings in the bond alignment. The openings were created with use of full and half bricks and the geometric shape was obtained by application of the horasan plaster.

These elements, which were placed on curved surfaces within the examined domes, are; pentagonal, hexagonal, circular, or star shaped. The placement of the oculi is generally in two or three circular rows, hexagonal in shape and in decreasing number towards the dome peak (Figure 3.43). Only in Düzce Hamamı southeast *halvet* dome, there are four circular oculi in the first row, five in the second row. Also on the Urla Hersekzade Ahmet Paşa Hamamı women's section *ılıkılık* space northwest unit dome the oculi is rectangular; on the Sığacık Kaleiçi Hamamı *halvets*, Urla Özbek Köyü Hamamı domes and Tire Hekim Hamamı domes the oculi are circular. In Ula Hamamı west *halvet* dome and Seferihisar Büyük Hamam *ılıkılık* space domes and southwest *halvet* dome, only the oculi in the center of the dome is star shaped and the others are hexagonal. In the segmented half domes of the side iwans of the *sıcaklık* main space of



Tire Tahtakale Hamamı, four hexagonal shaped oculi were provided on the lobe surfaces close to springing level, in two rows alternately.

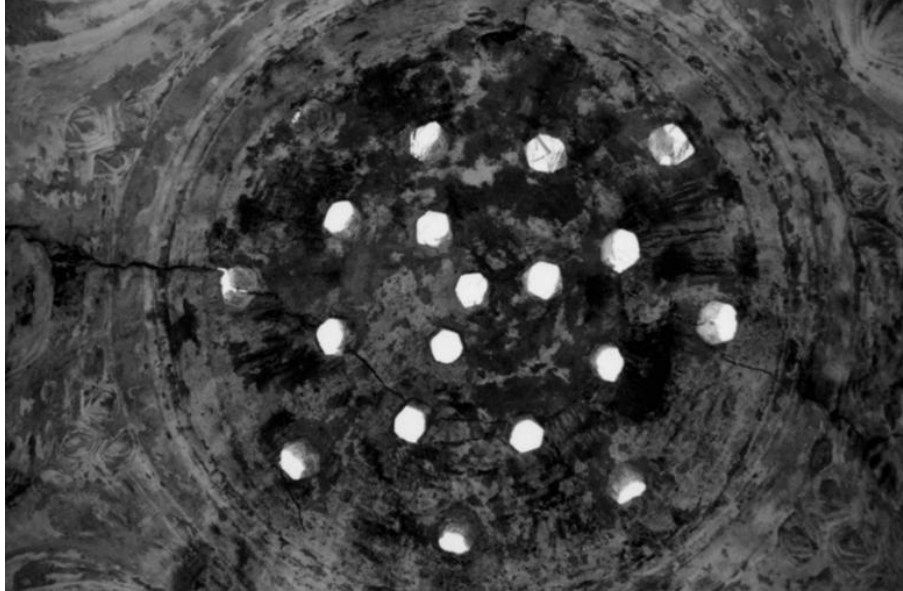

Figure 3.43. In the east *halvet* dome of Urla Kamanlı Hamamı, using hexagonal shaped oculi in circular three rows.

### **3.5.1.2. Oculi in Dome - Light Cupola or Top Skylight in the Center**

Oculi in dome - light cupola or top skylight in the center is examined under three topics. Those are; oculi arranged in the dome, light cupola arranged in the top of dome and top skylight arranged in the top of dome.

#### **3.5.1.2.1. Examination of the Light Cupolas in Domes**

The light cupolas on the top of dome that provide the disperse penetration of light are the oblate hemispherical lid shaped elements bonded out of brick. Usually the base is 60 to 80 centimeters in width and the inner height is 50 centimeters. The frames, on which the light cupolas were settled, are either circular or hexagonal. They are the lighting elements that were established by the formation of the bond or the placement of the terracotta elements among the bond at the dome center on the top.

The light cupolas were arranged in the top of; *ılıklik*, *sıcaklık* main space and *halvet* domes. It is possible to observe these lighting elements in Ulamış, Urla Hersekzade Ahmet Paşa, Tire Yalınayak Hamamı men's section and Kamanlı Hamams, only in the *sıcaklık* main space domes, in Düzce Hamamı southwest *halvet* dome, in Seferihisar Büyük Hamam *sıcaklık* main space and east *halvet* domes, in Seferihisar Küçük Hamam *sıcaklık* main space and *halvet* domes, in Tire Tahtakale Hamamı men's section *ılıklik*, *sıcaklık* main space and *halvet* domes, in Tire Eski-Yeni Hamam men's section *ılıklik*, *sıcaklık* main space and *halvet* domes.

On the light cupolas the hexagonal oculi formed through the terracotta pipes are in one or double circular rows. In the light cupola of *sıcaklık* main space dome of Ulamış Hamamı, a star shaped oculi was arranged only in the middle. In addition, despite the star shaped oculi usage in three circular rows in Tire Eski-Yeni Hamam *sıcaklık* main space dome, on the light cupola of this dome hexagonal oculi were located in two circular rows. Also in Seferihisar Büyük Hamam *sıcaklık* main space dome light cupola, the oculi were arranged in two circular rows, however in star shape.

As a result of the formation of the bonding or placement of terracotta elements in the bond at the dome peak, light cupolas were provided in two different types:

**1. Light cupola resulting from the formation of the bond:** Brick bond was arranged with the purpose to leave an opening of 60 to 80 centimeters in the keystone gap at the top. The bonding of bricks starts from a horizontal axis through the dome center and continues up to an angle that is parallel to the vertical axis through the center and then ends with the light cupola. This type of cupola usually has a hexagonal form. The thickness of the light cupola is between 15 to 20 centimeters and was formed by rows of radiant stacking of half brick units with binding lime mortar, and sliding of these rows horizontally with size of a quarter brick towards the center of the light cupola (Figure 3.44).



Figure 3.44. The use of lighting cupola in the northeast *halvet* domes of Tire Tahtakale Hamamı.

**2. Light cupola resulting from the placement of the terracotta elements at the top point:** These cupolas were formed with placement of terracotta elements that have the form of light cupola, among the radially stacked bond towards the center at the top of the dome. In some examples, the oblate hemispherical lid shape was obtained by a terracotta element that was placed only inside the dome section and the rest was bonded with half bricks aligned radially towards dome center with binding lime mortar. In other examples from these, terracotta element is a whole that continues along the dome thickness and completes the oblate hemispherical lid form. Generally they are circular shaped inside the dome thickness (Figure 3.45). In this example, the terracotta element coated brick bond made of half bricks with horasan plaster exterior.



Figure 3.45. The use of lighting cupola in southwest *halvet* dome of Tire Hekim Hamamı men's section.

### 3.5.1.2.2. Examination of the Top Skylights in Domes

Top skylight at the top of the dome is a lighting element designed by formation of the bonding. Similar to the central light cupola or oculus, the brick bond was organized with the principle to leave an opening of 25 to 40 centimeters in the keystone gap at the peak of the dome. The span of top skylight is 10 to 15 centimeters larger than oculi dimensions and 30 to 40 centimeters smaller than light cupola dimensions. They were constructed with the principle of adjacent stacking of half bricks vertical to the horizontal axis. Top skylight is observed only in Düzce (Hereke) Hamamı *sıcaklık* main space and in the segmented half dome of sub *iwans* in Tire Tahtakale Hamamı *sıcaklık* main space (Figure 3.46).

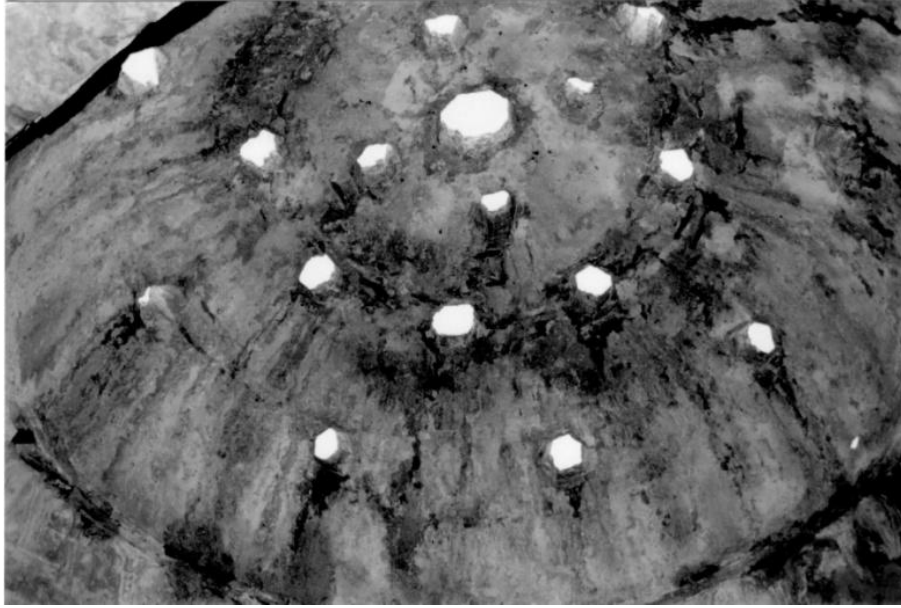

Figure 3.46. The use of top skylight in *sıcaklık* main space dome of Düzce Hamamı.

### 3.5.1.2.3. Examination of the Oculi in Domes with Light Cupola

In some domes with light cupola, oculi with identical dimensions were placed in different organizations or oculi with different sizes and shapes were used together to provide unusual and rich compositions on the dome surface.

The examples for domes with a light cupola and in which oculi were used decoratively are: Tire Tahtakale Hamamı, Yalınayak Hamamı, Hekim Hamamı and Urla Hersekzade Ahmet Paşa Hamamı. Unlike the other baths, in Tire Tahtakale Hamamı *ılıklık* dome the hexagonal oculi are in one or triple order (Figure 3.47). Organized in circular two rows, eight oculi in each, are double on the outer row close to springing level and one on the inner row. Via adjacent placement of double oculi to one oculus, triple and single orders were obtained. In the same baths' *sıcaklık* main space dome, ternary type oculi are in two rows with contrary directions. In this organization, circular and ternary eight oculi are double in inside and outside rows and one in middle row. Due to adjacent placement of inside and outside double rows to the one row in alternate manner, ternary order was obtained (Figure 3.48). In the *halvet* domes of these baths eight hexagonal shaped oculi were designed in three circular rows. In addition, in Urla Hersekzade Ahmet Paşa Hamamı women's section *sıcaklık* main space pyramidal dome, hexagonal oculi are in ternary order; double in outer row, one in inner row.



Figure 3.47. The use of hexagonal oculi in ternary type in the *ılıklik* main unit dome of Tire Tahtakale Hamamı.



Figure 3.48. The use of hexagonal oculi in ternary and single orders alternately in the *sıcaklık* main space dome of Tire Tahtakale Hamamı.

In Tire Yalınayak Hamamı men's section *sıcaklık* main space dome, the oculi exhibits a rich alignment (Figure 3.49). The oculi on the dome was located as to form a spiral alignment starting from a close level to the springing level towards the top.

Among the hexagonal seven oculi aligned in spiral form in eight circular rows, star shaped oculi were placed randomly.



Figure 3.49. The use of hexagonal oculi in spiral geometrical order with star shaped in between randomly in the *sıcaklık* main space dome of Tire Yalınayak Hamamı men's section.

Besides the examples of decorative oculi organizations, there are cases of relating the oculi with ornaments of the dome in Tire Tahtakale Hamamı and Hekim Hamamı. In Tahtakale Hamamı, in the interior surface of the depressed pyramidal dome of northwest iwan of *sıcaklık* main space, eight-strand star ornament was created with horasan plaster and on the edge of each strand an oculus was placed and the decoration was enhanced (Figure 3.50).



Figure 3.50. In Tahtakale Hamamı, in the interior surface of the depressed pyramidal dome of northwest iwan of *sıcaklık* main space, the use of eight-strand star ornament created with horasan plaster and placed oculus in each strand.

In Tire Hekim Hamamı men's section *ılıklik* dome and southwest *halvet* domes were designed as segmented domes; on the *ılıklik* dome circular shaped oculi were used in two circular rows and inside of lobe in the same direction vertically and on the *halvet* dome four circular rows of circular shaped oculi, with the lowest row placed inside the horizontal lobes each to achieve a rich geometrical pattern (Figure 3.51).

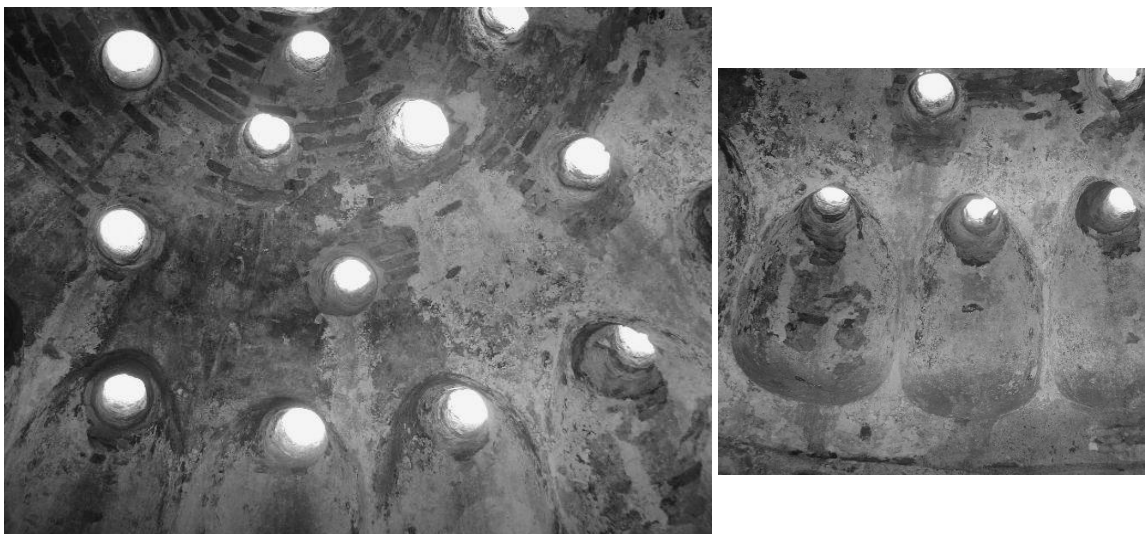

Figure 3.51. In Tire Hekim Hamamı men's section southwest *halvet* dome, the use of circular oculi on the curved surface of *halvet* dome and one oculus in each segment created in the dome.



Rich decorative patterns with use of different sizes and shapes were determined in Urla Kamanlı Hamamı, Seferihisar Büyük Hamam, Ulamış Hamamı, Tire Yalınayak Hamamı, Hekim Hamamı, and Eski-Yeni Hamam. The examples for use of hexagonal and star shaped oculi are observed in Urla Kamanlı Hamamı *sıcaklık* main space dome and Tire Yalınayak Hamamı men's section *sıcaklık* main space dome. The star shaped oculi is seen only in Seferihisar Büyük Hamam *sıcaklık* main space and southeast *halvet* dome and in Tire Eski-Yeni Hamamı *sıcaklık* main space dome (Figure 3.52). Apart from these examples; in Ulamış Hamamı west *halvet* dome and Seferihisar Büyük Hamam *ılıklik* space domes and southwest *halvet* dome, only the oculi at the dome center is star shaped where the others are hexagonal (Figure 3.53).



Figure 3.52. In Tire Eski-Yeni Hamamı men's section *sıcaklık* main space dome, the use of star shaped oculi in circular three rows and hexagonal shaped oculi in two rows on the lighting cupola at the top of dome.

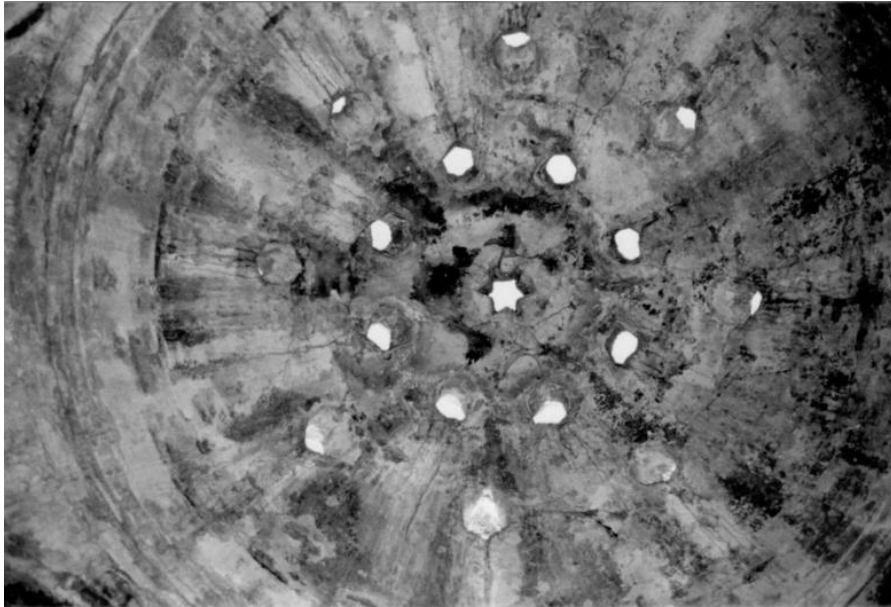

Figure 3.53. In Ulamiş Hamamı west *halvet* dome, the use of hexagonal shaped in two circular rows on the curved surfaces and on the top an oculus in star shape.

In Tire Hekim Hamamı men's section southeast *halvet* dome, a decorative and rich composition was formed through; placing the circular, different size small and large oculi together and in rows close to each other (Figure 3.54).



Figure 3.50. In Tire Hekim Hamamı men's section southeast *halvet* dome, for the purpose of space lighting penetrations the use of terracotta pipes in the brick bond.

### 3.5.2. Examination of the Lighting Lantern in Domes

The lighting lanterns are discussed under two topics as; “*lighting lantern in dome*” and “*lighting lantern in dome - windows at the springing level*”.

#### 3.5.2.1. Lighting Lantern in Domes

Lighting lantern is an element ascending on a frame constructed on the top of dome by stone or brick, in cases where the superstructure of the *soyunmalık* space is dome. In examined samples, lighting lanterns were formed by placing glass lids over a hexagonal frame in approximately between 50 and 60 centimeters height, built with brick bond. In Seferihisar Büyük Hamam *soyunmalık* dome, Tire Yalınayak Hamamı and Tire Eski-Yeni Hamam men’s ection *soyunmalık* dome and in Tire Tahtakale Hamamı *soyunmalık* dome, possible further refurbished lighting lanterns are observed (Figure 3.55).



Figure 3.55. In Tire Eski-Yeni Hamamı *soyunmalık* dome, the use of lighting lantern.

### 3.5.2.2. Lighting Lantern in Dome – Windows at the Springing Level

In some of the examples, lighting in the *soyunmalık* spaces was provided through window openings aligned at the springing level in addition to the lighting lantern at the top of dome. Window openings at the springing level is observed only in Düzce Hamamı and Tire Yalınayak Hamamı men's section *soyunmalık* spaces (Figure 3.56). The widths of the rectangular and depressed pointed arched windows at the springing levels are between 70 and 80 centimeters, heights are between 120 and 130 centimeters.



Figure 3.56. In Düzce Hamamı *soyunmalık* dome, the use of windows at the springing level.

### 3.5.3. Examination of the Oculi according to the Dome Spans

The relationship between the dome span and oculi span is as follows: the width of the oculi span in long-span domes is 25 to 40 centimeters on the inside and 19 to 25 centimeters on the outside; in mid-span domes 20 to 24 centimeters on the inside and 15 to 19 centimeters on the outside; in short-span domes 15 to 19 centimeters on the inside and 13 to 15 centimeters on the outside decreasing in dimension as narrowing from inside to outside. In the examples, the span width of the oculi was measured as uniform in opening rows towards the top. The circular oculi was formed by placement of

terracotta pipes among the bond while the pentagonal, hexagonal or star shaped ones are formed by bond pattern.

The oculi are mostly in two or three circular rows. The usage rate of the two and three rows oculi placed very close to each other and their ratios are 34.3% and 37.1% respectively. Use of one row oculi ratio is 12.9% (Figure 3.57).

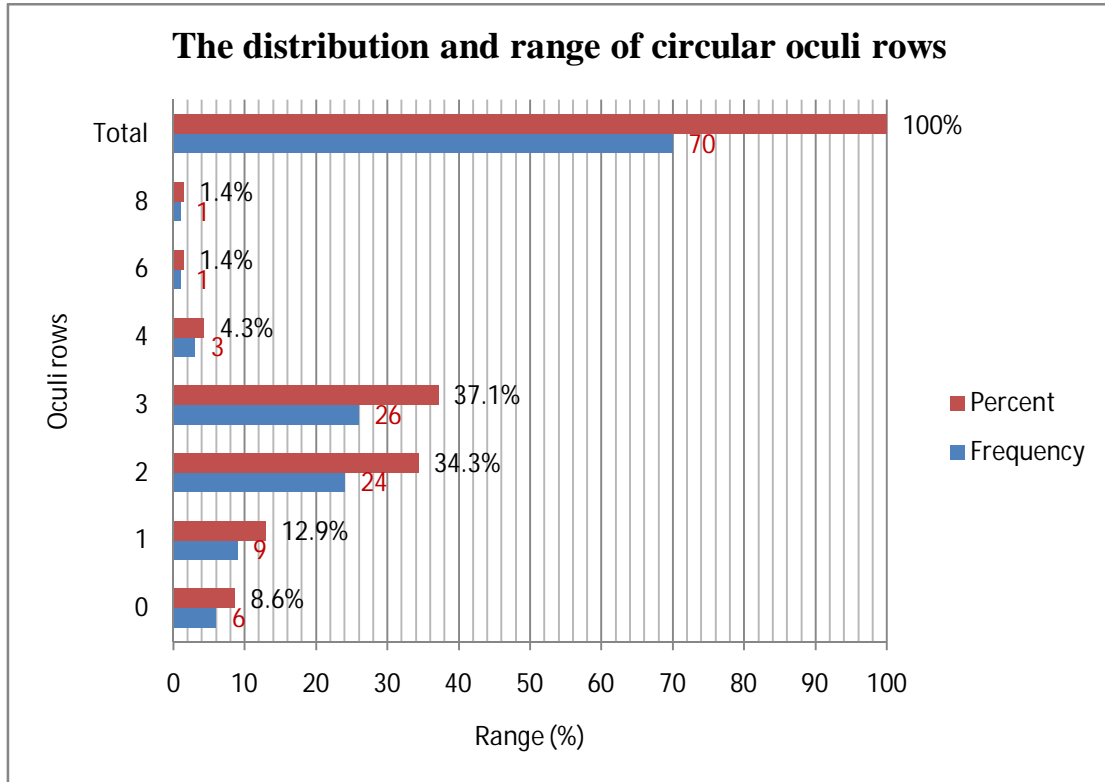

Figure 3.57. The distribution and range of circular rows in the examined domes.

The maximum oculi row observed in the domes is eight and was sampled only in Tire Yalınayak Hamamı men's section *sıcaklık* main space dome (Table 3.27). Urla Rüstem Paşa Hamamı *sıcaklık* main space dome with six oculi rows is another dome ascertained as the single example.

Table 3.27. The number of oculi rows and range in dome.

Oculi row number	Dome number	Range (%)
8	1	1.4%
6	1	1.4%
4	3	4.3%
3	26	37.1%
2	24	34.3%
1	9	12.9%
0 (at the peak)	6	8.6%
Total	70	100%

### 3.5.4. Evaluation of the Dome Span and Number of Oculi Relation in Domes

Within the examined domes, the linear relationship between the dome span and the number of oculi aligned on the dome is presented in Figure 3.58.

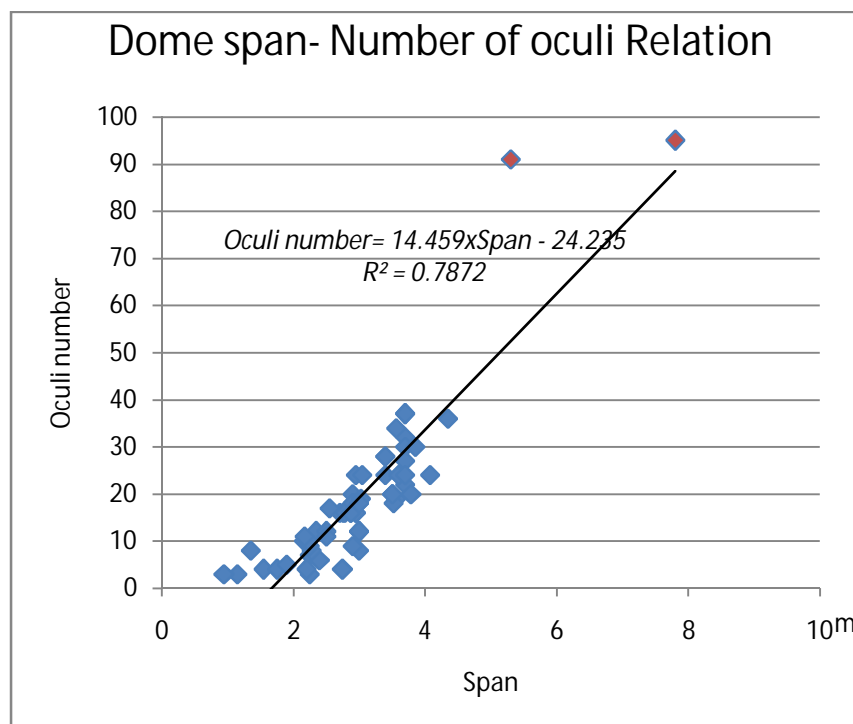

Figure 3.58. The relationship between span and the number of oculi in all domes.

According to the chart, it is possible to assess that in domes with a span between 2.0 and 4.5 meters, the number of oculi increases as the span increases. The mid-span

Rüstem Paşa Hamamı *sıcaklık* main space dome shown in the chart is the only sample which does not contribute to this linear feature. In Rüstem Paşa Hamamı *sıcaklık* main space dome, the number of oculi is 91, though it should be 52 in response to the 5.30 meters span. The long-span Tire Yalınayak Hamamı *sıcaklık* main space dome, which expose a linear feature in the relationship between span-number of oculus hence has a very different amount and distribution of oculi in comparison to the other samples, is the only sample among the long-span domes in which the oculi was used. In this dome 96 oculi were used in response to 7.80 meters span.

Observing the relationship between dome span and number of oculus presented in the chart, it is possible to denote that domes with oculus commonly have spans between 2.0 and 4.5 meters and the span should be minimum 2.0 meters for use of oculus. In only one long-span domes is there use of oculus, Tire Yalınayak Hamamı men's section *sıcaklık* main space dome with a span of 7.80 meters. According to the chart, in a dome with 2.0 meters span, 5 oculi are located, in a dome with 5.0 meters span 48 oculi are located.

Excluding the only sample which does not fit the linear relationship of span and number of oculus, the relation between the span and the number of oculus is given in Figure 3.59.

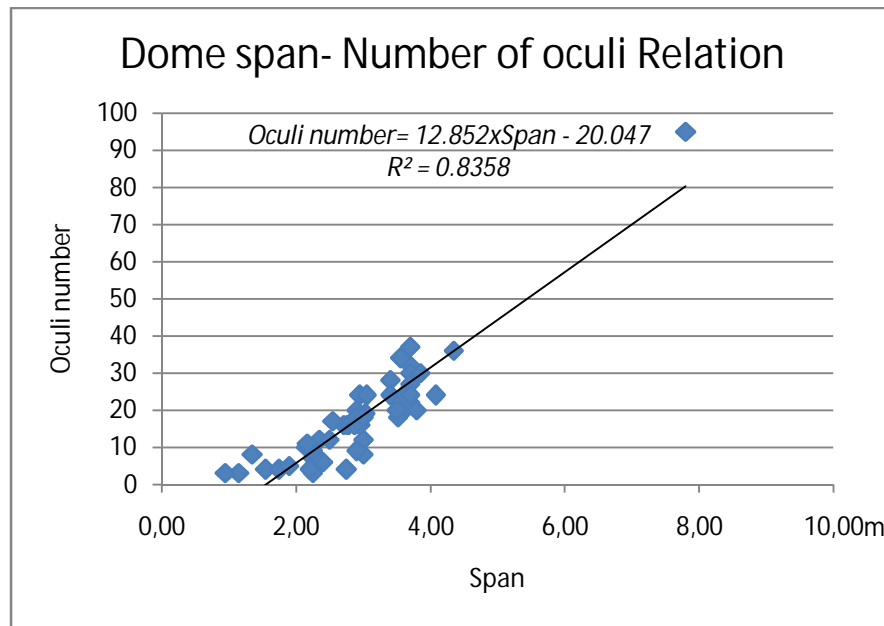

Figure 3.59. The relationship between span and the number of oculi in common domes.

In examination of the relationship between the span and number of oculus; in case of evaluating the number of oculus in each lighting row instead of the total number of oculus in the dome, a weaker relationship is observed in terms of evaluation of all domes. However, the relationship ratio presents differences for every lighting row (Figure 3.60).

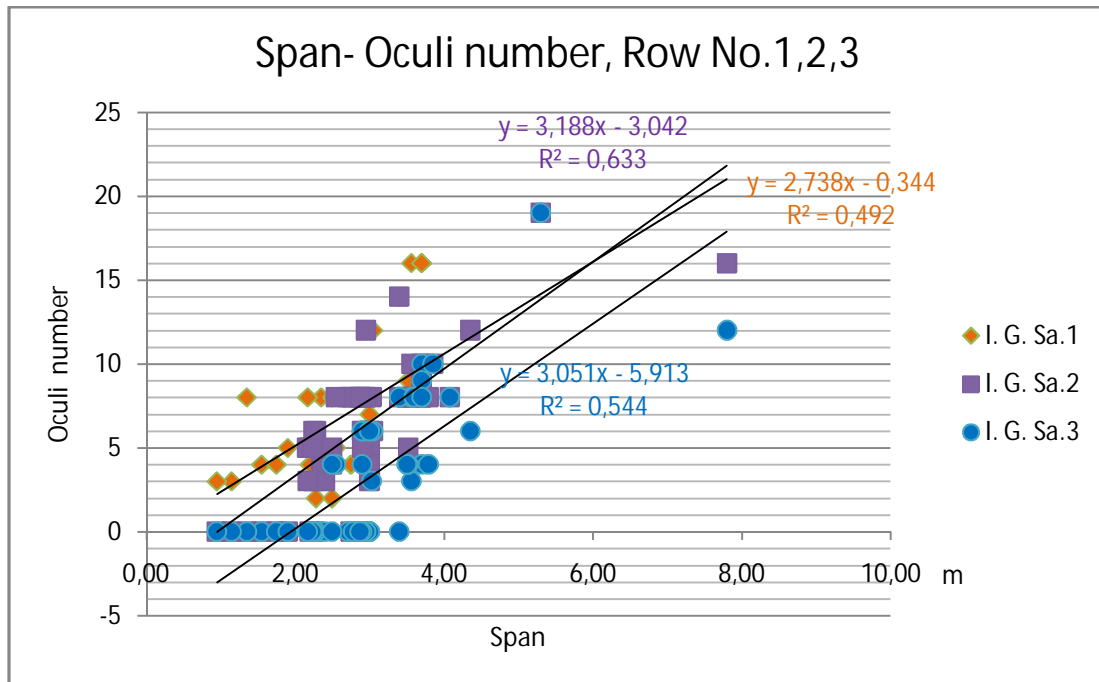

Figure 3.60. The relationship between span and the number of oculi in the first three circular rows from outside toward inside of domes.

Frequently, there are three oculi circular rows from inside to outside in the domes. Due to evaluation of the relationship between span and number of oculus, to have oculi in the first two rows the dome span should be 2.0 meters minimum and to have a third oculi row the dome span must be 3.0 meters minimum. Commonly, in a dome with a span of 2.0 meters there are 5, and in a dome with a span of 5.0 meters there are 14 oculi in the first row, in the second row there are 3 and 12 oculi respectively. From inside to outside, in the third oculi row, the number of oculi in 3.0 and 5.0 meters span domes are 3 and 9 respectively.

Throughout the domes examined it is observed that oculi are mostly present in short and mid span domes, more specifically in *ılıklik* main unit, *ılıklik* sub-unit, *sıcaklık*



main unit and *halvet* domes. Among mid-span domes, Rüstem Paşa Hamamı *sıcaklık* main space dome is the only example that diverges with the differentiation of number of oculi. In addition, Tire Yalınayak Hamamı men's section *sıcaklık* main space dome with a span of 7.80 meters is the only example for use of oculi long-span domes except the *soyunmalık* domes. In long-span *soyunmalık* domes, although lighting was provided via use of lighting lanterns or windows placed in the springing or transition zone, In Yalınayak Hamamı men's section *sıcaklık* main space dome lighting was provided by oculi on curved surfaces and lighting cupola at the top. This determination is important in terms of the question of why there is a use of oculi, eventhough the dome is long-span.

### 3.6. Transition Elements to Examined Domes

The treatment of the dome and its cupola as crowning element in the middle is almost the same in every domical form. The feature of these structures depends on the relationship between the transition elements and their connections. Structural behavior of the domes can be determined by the nature of connections of dome base and transition elements, geometrical relations of the elements, and the overall geometry of the form (Figure 3.61). Transition elements can be generally seen as below order: Squinches, pendentives, Turkish triangles.

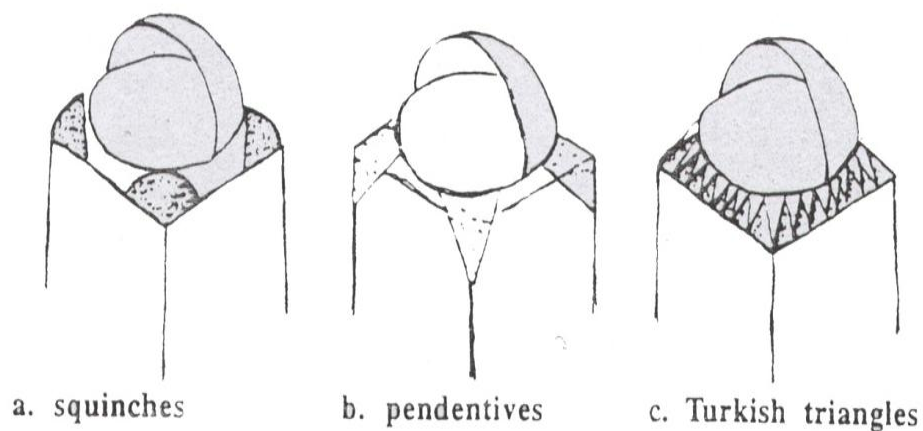

Figure 3.61. Transition elements to the dome and the relation  
(Source: Turan 1993).

### **3.6.1. The Types of the Transition Elements to the Dome**

In general, the utilization of transition elements to domes and types of which have been commonly widespread hitherto for all settlements for the domes with span up to twelve meters (Arik 1993). In the use of transition elements to domes, transitions can be seen in different forms of common types, such as common spherical pendentives can be seen in pyramidal type of triangle surfaces. The second common type of transition elements is squinches that convert square ground plan to the octagonal frame composed of arches.

There is a linear relationship between dome span and height of transition zones. In case the span increases the transition zone increases, which is not preferred for the spatial quality of a space. In order to preclude increasing case in height of transition zone pendentives were generally preferred to be used in the long-span domes. The choice can be seen distinctly in the long-span domes of Ottoman architecture.

In the examined domes the cases of increasing transition zone have not been encountered due to all the examined domes are less than twelve meters. However, the common type of transition element to all examined domes is identified as pendentives.

In the baths, generally, the type of the single dome on perimeter walls was performed as basic and pure in geometrical sense. In this type the structural transition elements become the most critical design decisions since the dimensioning of the perimeter walls and spatial quality of the interior space depend highly on this construction detail. The structural behavior of domes and the supporting systems depends on the transition elements used in the transition from circular to rectangular geometry in the construction. Two of the basic transition elements, namely pendentives and squinches, transfer the forces from the dome to the walls in a localized manner causing concentration of both vertical and horizontal forces on small areas. The horizontal component of the outward thrust carried from the main dome creates considerable problems on the structural elements they sit on. The third system of transition elements, the Turkish triangles, is a structural belt composed of folded triangular surfaces adapting to the circular base of the dome with a polygonal shape. This transitional belt tends to distribute the load of the dome more uniformly than the other two transition elements.

### **3.6.1.1. Pendentives**

The pendentives provide smooth transition from square to a circular dome as spherical upside down triangles. These elements came from Byzantine to Ottoman architecture. It is an inverted spherical-triangular surface between the grand arches which supports the dome and the dome's base. They were built with bricks and mortar as binder by forming 2-4 cm joints. On concave surfaces, bricks were bonded in horizontal joints.

Fragments of a sail-vault resembling a species of concave, distorted almost triangular spandrels, rising up from the corner at the top of the right-angled compartment to the circular or elliptical base of the drum or dome (Curl and Sambrook 1999, s.202).

### **3.6.1.2. Squinches**

The squinches, which resemble a quarter domes, provide transition between the two sections like pendentives. They entered Ottoman architecture from the Seljuks. On the upper part of the wall corners, the squinches, which were built with bricks and lime mortar as binder, form a suitable octagonal base for the dome. When the squinch, used to cover an area, it leaves small openings at the top and bottom which were covered by small pendentives. They were bond in regular courses with horizontal wide joints. The squinch arches in disrobing areas are approximately 55 cm in width and were built with one and a half bricks. Small arch or series of parallel arches of increasing radius spanning the angle of the square compartment (Curl and Sambrook 1999, p.202).

### **3.6.1.3. Turkish Triangles**

The corners of the base and the top of the prismatic triangle units were connected to each other by turns in the form of lozenge shape. They are composed of a series of triangles alternatively pointing up and down. Unlike pendentives and squinches, Turkish triangles were used not only to make the transition between a square place and circular dome, but also pass from square forms to the polygonal forms. The

Turkish triangles were built with bricks forming large joints. The final form of bond lines were cut and roughly shaped after the blocks were laid.

In some small spaces, the transition from square to the circular dome base was provided by plain triangles formed by one or two units arranged on the corners. They formed large joints on horizontal brick bond courses. Brick bond starts from the corner of the wall and goes up to the top of triangle.

### 3.6.2. Examination of Transition Elements to Domes

The distribution of transition elements to domes according to dome spans in different spaces is presented in Table 3.28. Transition to the domes were obtained in forty-four short-span domes as thirty-two pendentives, five Turkish triangles, four squinches, three plain triangles, and one combined with pendentive and squinch. In twenty-seven mid-span domes, transition elements to domes are distributed as thirteen pendentives, six Turkish triangles, two squinches, five plain triangles, and one combined with squinch and plain triangle. Among the total seven long-span domes transition to domes were provided in three domes with pendentives, in three domes squinches and in one dome with Turkish triangles.

Table 3.28. The distribution of transition elements to the domes in spaces according to their spans.

Domes	Pendentives	Turkish Triangles	Squinches	Plain Triangle	Total
Short-span domes	31.5	5	4.5	3	44
Mid-span domes	13	6	2.5	5.5	27
Long-span domes	3	1	3	0	7
Total	47.5	12	10	8.5	78
Range (%)	61%	15%	13%	11%	100%

The amounts of transition elements in each spatial component of baths are given in Table 3.29. Consequently, among the total thirty-six *halvet* domes the transition to domes were obtained with twenty-three pendentives, six Turkish triangles, five squinches, one plain triangle and the other one combined with pendentive and plain triangle. The transition elements to the total twenty *sıcaklık* main spaces have a

distribution of fourteen pendentives, five plain triangles and one is Turkish triangles. Transition to the total nine *ılıklik* main unit domes was obtained with five pendentives, two Turkish triangles, one squinch and the other one plain triangle while transition to seven *ılıklik* sub-unit was obtained with three pendentive, two Turkish triangles, one squinch and the other with plain triangle. Finally, transition elements among six of the *soyunmalik* domes have a distribution of three squinches, two pendentives, and one Turkish triangles. In addition, there are no squinch in *sıcaklık* main spaces and no plain triangle in the *soyunmalik* spaces as transition elements to the domes.

Table 3.29. The distribution of transition elements to the domes in spaces

Domes	<i>Soyunmalik</i>	<i>ılıklik</i> sub-unit	<i>ılıklik</i> main unit	<i>Sıcaklık</i> main space	<i>Halvet</i>	Total	Range (%)
Pendentive	2	3	5	14	23.5	47.5	61%
Turkish Trianges	1	2	2	1	6	12	15%
Squinch	3	1	1	0	5	10	13%
Plain Triangle	0	1	1	5	1.5	8.5	11%
<b>Total</b>	<b>6</b>	<b>7</b>	<b>9</b>	<b>20</b>	<b>36</b>	<b>78</b>	<b>100%</b>

The distribution of transition elements to examined domes according to their spans in spatial components of baths point out that, in the short-span, mid-span and long span domes pendentives that are the highest in number occupy 61% among total all domes, Turkish triangles occupy 15% while squinches occupy 13% and plain triangle occupy 11% of whole examined domes. Pendentives that are common transition element to all examined domes occupy the middle in number in the short span and mid-span *halvet* domes and 1:3 of total number in the short-span, mid-span and long-span domes of *sıcaklık* main spaces respectively. Turkish triangles occupy the middle in number in *halvet* domes and 1:3 in short-span and mid-span domes of *ılıklik* spaces respectively. Squinches have a distribution the middle of total number in *halvets* and 1:3 in *soyunmalik* spaces while plain triangles occupy more than middle of total number in *sıcaklık* main spaces as transition elements to domes (Table 3.30).

Table 3.30. The distribution of transition elements in spatial components.

Transition Elements	<i>Soyunmalık</i>	<i>Ilıklık sub-unit</i>	<i>Ilıklık main unit</i>	<i>Sıcaklık main space</i>	<i>Halvet</i>	Range (%)
<b>Pendentive</b>	2.56%	3.85%	6.41%	17.94%	30.12%	61%
<b>Turkish Trianges</b>	1.28%	2.56%	2.56%	1.28%	7.69%	15%
<b>Squinch</b>	3.85%	1.28%	1.28%	0%	6.41%	13%
<b>Plain Triangle</b>	0%	1.28%	1.28%	6.41%	1.92%	11%
<b>Total</b>	7.69%	8.97%	11.53%	25.64%	46.15%	100%

### 3.6.3. Evaluation of the Relationship between Span and Height of Transition Elements

Within the study, spans and heights of transition elements in the 78 domes that were used of the total 79 domes have been examined. In this examination of the relationship between the span and height of transition elements in these domes, it is determined that the height increases linearly as the span increases. The linear relation between the span and the height of transition elements can be seen in the chart given in Figure 3.62. Accordingly; the proportion of height to span is 10 centimeters of height of transition elements for approximately 1 meter of span, thus the height is 1.0 m in 10 m span. Within this framework it can be asserted that the ratio of the height to the span is 0.10.

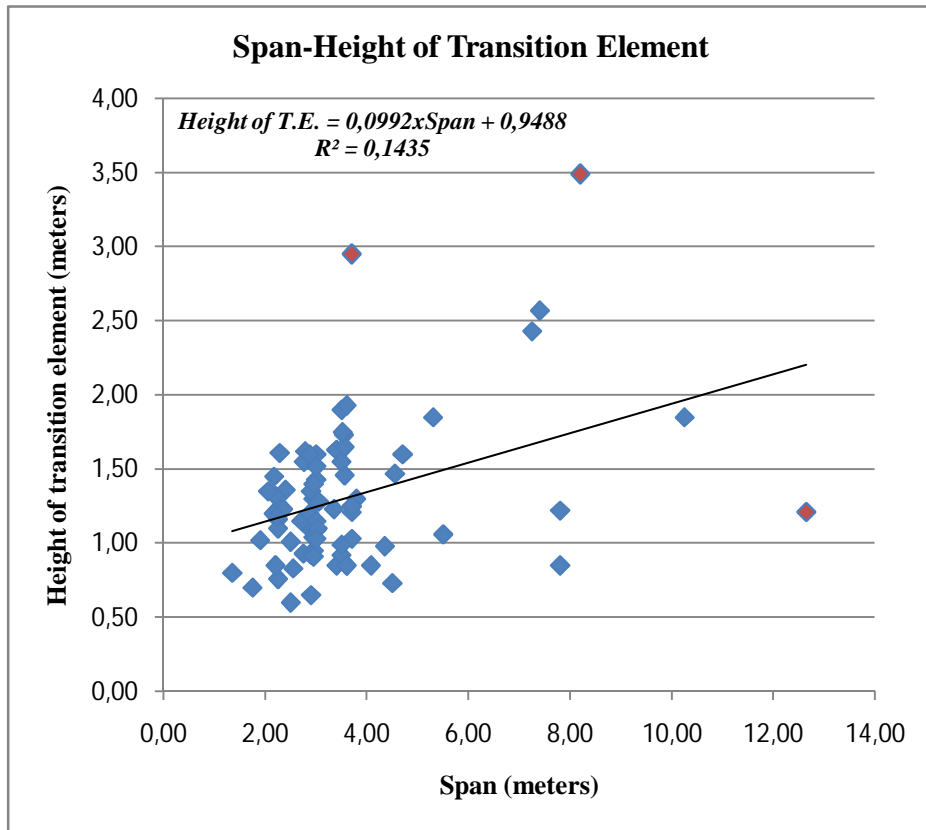

Figure 3.62. The relationship between span and height of transition elements in all examined domes.

In consequence of exclusion of three domes which are residuals in the linear span-height of transition element relation; the common span-height of transition element relation is presented in the chart in Figure 3.63. However, the relationship between them does not change.

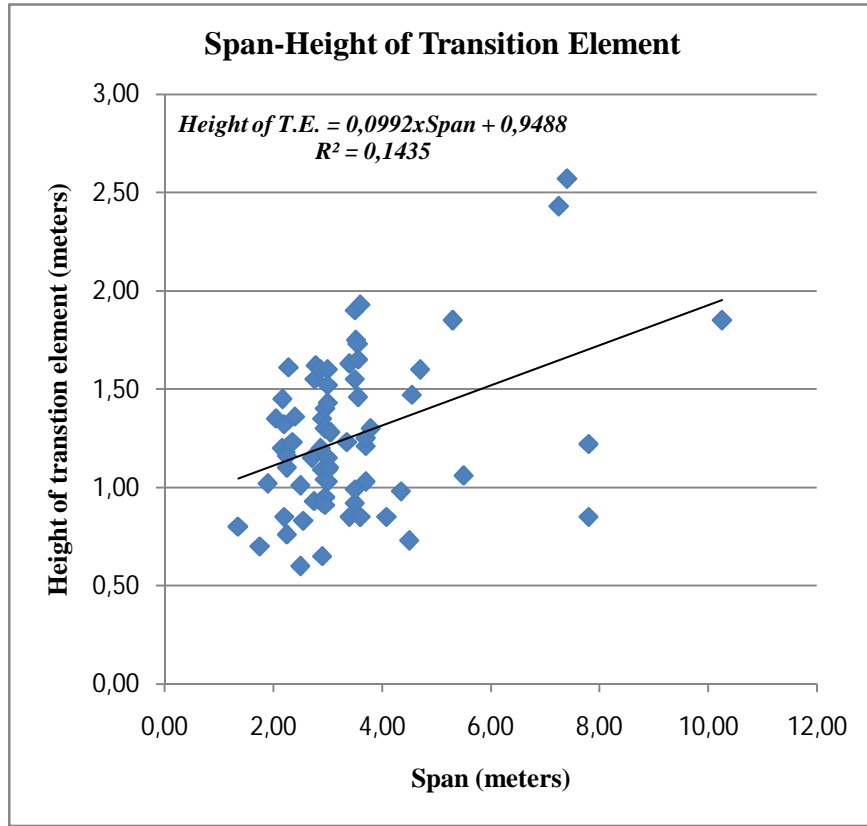

Figure 3.63. The relationship between span and height of transition elements in common domes.

The domes, which deviate from this linear span and height of transition element relation, are Tire Yalınayak Hamamı men's section *soyunmalık* dome (span: 8.20 m; height of t. e: 3.39 m), Tire Tahtakale Hamamı men's section *soyunmalık* dome (span: 12.65 m; height of t. e: 1.21 m), and Urla Hersekzade Ahmet Paşa Hamamı women's section *sıcaklık* main space dome (span: 3.70 m; height of t. e: 2.95 m). The transition to dome was obtained with Turkish triangles in Tire Tahtakale Hamamı *soyunmalık* space whereas with pendentives in the other two spaces.

The ratio that is 1:10, which was defined in the relationship between span and height of transition element, is the same with the ratio between projection distance on the horizontal level along dome impost line that is coming from tensile part of dome at the springing level exterior including area of  $103^\circ$  from the dome centre towards dome top and dome span. Consequently, the ratio points out that the transition elements were utilized in conscious in order to prevent tensile stresses at the springing level of domes and to transfer the load from the dome to walls and from there to ground.



In the masonry-shell structures, the fact that the geometrical and structural situations develop regarding the construction techniques and material conditions caused the development and trial of different elements in the transition-phase towards dome. It can be stated that, in the shell systems like domes, the structural behavior is related with the transition elements to dome. Shell-system structures can be classified according to the dome bearing systems (substructures). If the transition elements to dome like the pendentives, squinches and Turkish triangles are compared with each other, it can be claimed that Turkish triangles distribute the loads of dome uniformly to substructures (to walls and foundations), (Turan 1993, p.343).

It can be said that the structural behavior of domes (transfer of self-loads to substructure) is strongly related with the geometrical characteristics of the domes and transition elements to dome. In other words, by the examinations on domes with spans in 12–21 meters, D’Ayala emphasized that the span, thickness and volume of the dome determine the structural behavior (D’Ayala 1993, p.347-355). It is noted that the same situation is also relevant for the bath-domes.

Concerning the dome construction techniques and bearing systems, it can be seen in the examined domes that the dome structure is simple, its geometry is regular, and its supporting manner to the substructure is uniform through the periphery.

### **3.7. Examination of the Relationship between Span and Height of Exterior Supporting Elements in Domes**

Within the total 79 examined domes, 31 domes were held up with exterior supporting elements. The supporting elements that are generally in octagonal frame and a height of springing level of the domes for each case are structural elements for preventing tensile stresses of domes at the springing levels. The utilization of exterior supporting elements, which have the same construction techniques and use of materials with the flesh walls, in spatial components of examined baths can be seen in Table 3.31 below.

Table 3.31. The use of exterior supporting elements in the spatial components.

Baths	Space	Height	Span	Transition E.	Height of Ext.S.E.
Tire Tahtakale H.	<i>ılıklik</i> sub-unit	0.81	2.35	Turkish Triangles	0.45
Ulamış H.	<i>sıcaklık</i> main space	1.26	2.71	Pendentive	0.65
Tire Hekim H.(W)	<i>ılıklik</i> sub-unit	0.91	2.75	Plain triangle	0.65
Tire Hekim H.(W)	<i>ılıklik</i> main space	1.10	2.76	Pendentive	0.70
Seferihisar Küçük H.	<i>sıcaklık</i> main space	1.50	2.90	Plain triangle	0.60
Seferihisar Büyük H.	<i>sıcaklık</i> main space	1.10	2.95	Pendentive	0.65
Urla Hersekzade Ahmet Paşa H.(M)	<i>ılıklik</i> main space	1.60	3.00	Pendentive	0.20
<b>Tire Hekim H.(M)</b>	<b><i>sıcaklık</i> main space</b>	<b>1.51</b>	<b>3.05</b>	<b>Plain triangle with two slices in the corners</b>	<b>1.30</b>
<b>Tire Tahtakale H.</b>	<b>iwan unit</b>	<b>0.69</b>	<b>3.35</b>	<b>Pendentive with Muqarnass</b>	<b>0.45</b>
<b>Tire Hekim H.(M)</b>	<b><i>ılıklik</i> main space</b>	<b>1.49</b>	<b>3.40</b>	<b>Segmented squinch</b>	<b>1.10</b>
<b>Tire Tahtakale H.</b>	<b><i>sıcaklık</i> main space</b>	<b>1.49</b>	<b>3.40</b>	<b>Turkish triangles</b>	<b>0.70</b>
<b>Düzce (Hereke) H.</b>	<b><i>sıcaklık</i> main space</b>	<b>1.76</b>	<b>3.50</b>	<b>Pendentive</b>	<b>0.45</b>
<b>Tire Yeniceköy H.</b>	<b><i>halvet</i></b>	<b>1.35</b>	<b>3.50</b>	<b>Pendentive</b>	<b>0.60</b>
<b>Urla Hersekzade Ahmet Paşa H.(M)</b>	<b><i>sıcaklık</i> main space</b>	<b>collapsed</b>	<b>3.55</b>	<b>Pendentive</b>	<b>0.45</b>
<b>Urla Kamanlı H.</b>	<b><i>sıcaklık</i> main space</b>	<b>1.10</b>	<b>3.56</b>	<b>Pendentive with Muqarnass</b>	<b>0.45</b>
<b>Urla Hersekzade Ahmet Paşa H.(W)</b>	<b><i>sıcaklık</i> main space</b>	<b>1.90</b>	<b>3.70</b>	<b>Pendentive</b>	<b>0.50</b>
<b>Tire Hekim H.(W)</b>	<b><i>sıcaklık</i> main space</b>	<b>1.44</b>	<b>3.70</b>	<b>Plain triangle with two slices in the corners</b>	<b>1.10</b>
<b>Tire Yeniceköy H.</b>	<b><i>sıcaklık</i> main space</b>	<b>1.46</b>	<b>3.70</b>	<b>Plain triangle</b>	<b>0.45</b>
<b>Tire Hekim H.(M)</b>	<b><i>halvet</i></b>	<b>1.44</b>	<b>3.70</b>	<b>Turkish triangles</b>	<b>1.40</b>
<b>Seferihisar Küçük H.</b>	<b><i>halvet</i></b>	<b>1.80</b>	<b>3.79</b>	<b>Pendentive</b>	<b>1.65</b>
<b>Tire Tahtakale H.</b>	<b><i>ılıklik</i> main space</b>	<b>1.77</b>	<b>4.08</b>	<b>Turkish triangles</b>	<b>0.75</b>
<b>Tire Karagazi H.(W)</b>	<b><i>ılıklik</i> main space</b>	<b>collapsed</b>	<b>4.50</b>	<b>Turkish triangles</b>	<b>0.80</b>
<b>Tire Karagazi H.(M)</b>	<b><i>halvet</i></b>	<b>collapsed</b>	<b>4.55</b>	<b>Plain triangle</b>	<b>0.45</b>
<b>Tire Karagazi H.(M)</b>	<b><i>sıcaklık</i> main space</b>	<b>collapsed</b>	<b>4.70</b>	<b>Plain triangle</b>	<b>0.75</b>
<b>Tire Karagazi H.(M)</b>	<b><i>ılıklik</i> main space</b>	<b>collapsed</b>	<b>5.50</b>	<b>Plain triangle</b>	<b>0.85</b>
<b>Düzce (Hereke) H.</b>	<b><i>soyunmalık</i></b>	<b>3.15</b>	<b>7.25</b>	<b>Squinch with Plain triangle</b>	<b>1.20</b>
<b>Seferihisar Büyük H.</b>	<b><i>soyunmalık</i></b>	<b>3.20</b>	<b>7.40</b>	<b>Segmented squinch</b>	<b>1.20</b>
<b>Tire Yalınayak H.(W)</b>	<b><i>soyunmalık</i></b>	<b>3.20</b>	<b>7.80</b>	<b>Squinch</b>	<b>1.20</b>
<b>Tire Yalınayak H.(M)</b>	<b><i>sıcaklık</i> main space</b>	<b>2.56</b>	<b>7.80</b>	<b>Serrated Pendentive</b>	<b>1.10</b>
<b>Tire Yalınayak H.(M)</b>	<b><i>soyunmalık</i></b>	<b>3.57</b>	<b>8.20</b>	<b>Pendentive</b>	<b>2.10</b>
<b>Tire Eski-Yeni H.(M)</b>	<b><i>soyunmalık</i></b>	<b>5.10</b>	<b>10.25</b>	<b>Pendentive</b>	<b>1.60</b>
<b>Tire Tahtakale H.</b>	<b><i>soyunmalık</i></b>	<b>4.93</b>	<b>12.65</b>	<b>Turkish triangles</b>	<b>1.10</b>

Short-span domes

Mid-span domes

Long-span domes

The distribution of exterior dome supporting elements according to the dome spans in spatial components is presented in Table 3.62. Within the forty-five short-span domes, the ten domes were supported by exterior dome supporting elements that are generally in octagonal forms. In these supported domes there is no any *aralık* and *halvet* dome. Additionally, exterior dome supporting elements were utilized in the five domes of nine *sıcaklık* main space domes, the three domes of six *ılıklik* main unit and the two domes of seven *ılıklik* sub-units as in the five of total thirteen *ılıklik* space domes. Among the twenty-seven mid-span domes fourteen were supported by exterior dome supporting elements. Within these fourteen domes, four are *halvets*, seven are *sıcaklık* main space and three are *ılıklik main unit* domes. The total seven long span domes were all supported by exterior supporting elements (Table 3.32).

Table 3.32. The distribution of exterior supporting elements in spatial components according to the dome spans.

<b>Baths</b>	<i>Soyunmalık</i>	<i>Aralık</i>	<i>ılıklik</i> sub-unit	<i>ılıklik</i> main unit	<i>Sıcaklık</i> main space	<i>Halvet</i>	<b>Total</b>	<b>Range (%)</b>
Short span domes	0	<b>0/1</b>	<b>2/7</b>	<b>3/6</b>	<b>5/9</b>	<b>0/22</b>	<b>10/45</b>	12.65%
Mid-span domes	0	0	0	<b>3/3</b>	<b>7/10</b>	<b>4/14</b>	<b>14/27</b>	17.72%
Long-span domes	<b>6/6</b>	0	0	0	<b>1/1</b>	0	<b>7/7</b>	8.86%
<b>Total</b>	<b>6/6</b>	<b>0/1</b>	<b>2/7</b>	<b>6/9</b>	<b>13/20</b>	<b>4/36</b>	<b>31/79</b>	39%

Consequently, exterior supporting elements were applied to the total long-span domes, half of mid-span domes and less than ¼ ratios of short span domes in number. Hence, the situations point out that there is some relationship between dome spans and exterior supporting elements. Additionally, in case of increasing domes span was identified that the domes were supported with exterior supporting elements for the tensile stresses at the springing levels. However, four mid-span domes that were supported by exterior supporting elements were observed as collapsed. These cases point out that domes have been in danger be cause of vandalism contrary to structural problems cause of tensile stresses at the springing levels.

### 3.7.1. Evaluation of the Relationship between Span and Height of Exterior Supporting Elements in Domes

Within the total seventy-nine domes, thirty-one domes that were supported by exterior supporting elements were examined and evaluated by the use of statistical analyses. In this examination of the relationship between the span and height of exterior supporting element, it was determined that the height increases linearly as the span increases. The linear relation between the span and the height can be seen in the chart given in Figure 3.64. Accordingly; the proportion of height to span is 12 centimeters of height for approximately 1 meter of span, thus the height is 1.2 m in 10 m span. Within this framework it can be asserted that the ratio of the height to the span is 0.12.

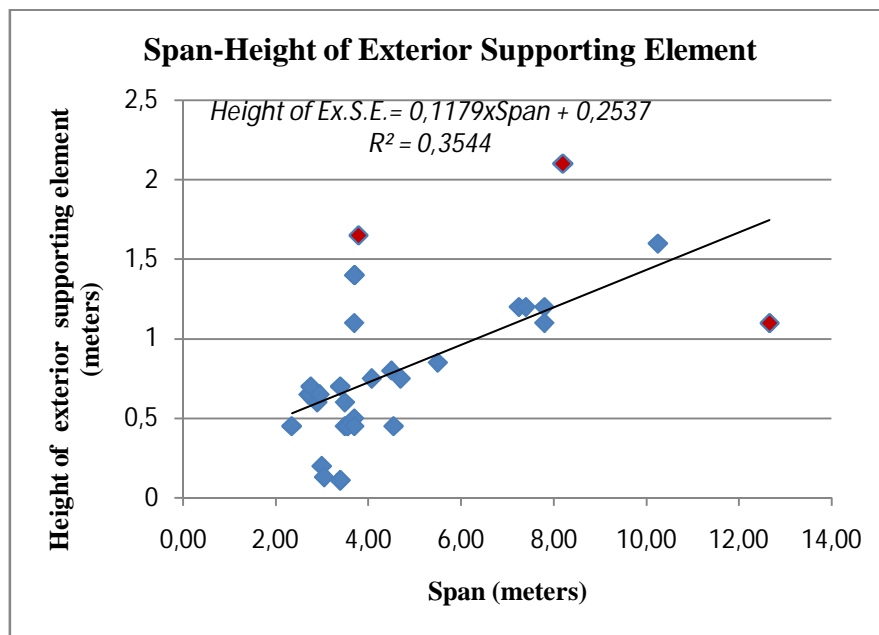

Figure 3.64. The relationship between span and height of exterior supporting elements in all examined domes.

The domes, which deviate from the linear span and height of exterior supporting element relation, are Tire Yalınayak Hamamı men's section *soyunmalık* dome (span:8.20; height of ex.s.e.:2.10), Tire Tahtakale Hamamı men's section *soyunmalık* dome (span:12.65; height of ex.s.e.:2.95), Tire Hekim Hamamı women's section *ılıklik*

main space segmented dome (span:3.40; height of ex.s.e.:1.40), and Seferihisar Küçük Hamam *halvet* dome (span: 3.79; hight of ex.s.e.:1.65).

Since the exterior supporting elements were constructed in two drums successively in Tire Yalınayak Hamamı men's section *soyunmalık* dome and Seferihisar Küçük Hamam *halvet* dome, the exterior supporting elements are higher than the chart line whereas in Tire Tahtakale Hamamı *soyunmalık* dome the exterior supporting element is lower. Being segmented Tire Hekim Hamamı women's section *ılıkılık* main space dome may have provided more than the height of the exterior supporting element according to the rate of other domes. However, in the dome of Tire Hekim Hamamı the exterior supporting element is in a cylinder form that is different from all the other domes as a unique case and coated with horasan mortar in 10-15 centimeters thickness including small and large pieces of bricks, stones, and tiles with traditional Turkish tiles covered (Figure 3.65). Additionally, in this dome due to the exterior supporting element were placed randomly from outside conversely placement in the dome centre points the impression out that the exterior supporting element in cylinder form were also constructed for exterior ornamental purposes.



Figure 3.65. In the dome of ılıkılık/sıcaklık main space west sub-unit of Tire Hekim Hamamı women's section, the use of horasan mortar including small and large pieces of bricks, stones, and tiles with traditional Turkish tiles covered on the exterior.

The result of the statistical analysis for the common span and height of exterior supporting element relation is presented in Figure 3.66, by excluding the four residual dome examples, which do not correspond to the linear relationship of span and height of exterior supporting element, from the model.

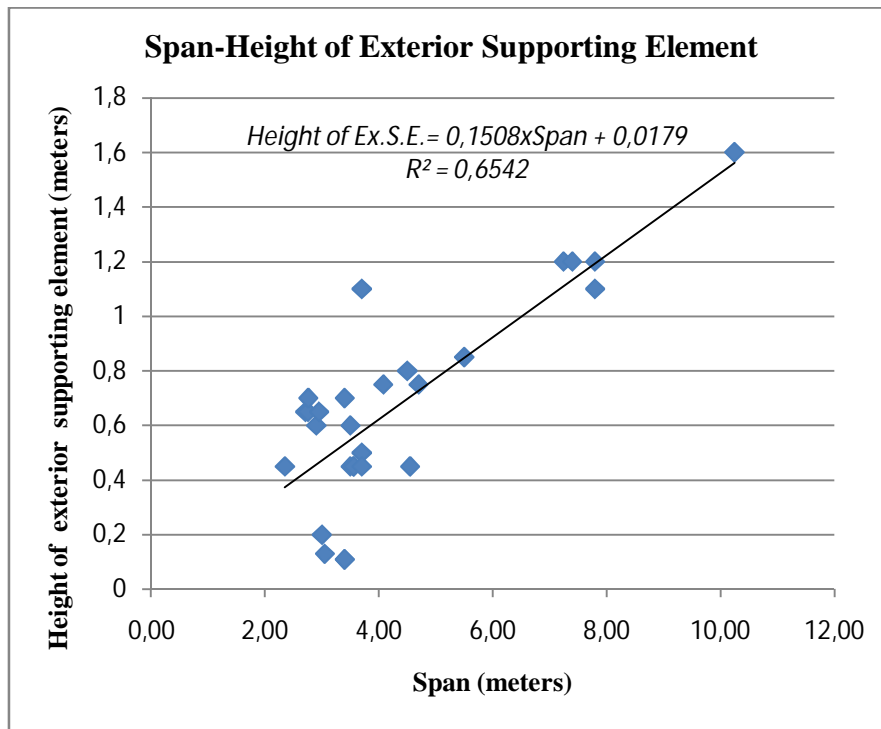

Figure 3.66. The relationship between span and height of exterior supporting elements in common domes.

Accordingly, in the relationship between span and height of exterior supporting element the ratio is 0.15 in the common domes. The ratio points out that the exterior supporting element to the dome span has values between 0.11 and 0.15 in common domes that have exterior supporting elements.

Eventually, examinations point out that there are some relations among dome dimensions, transition elements to domes and dome exterior supporting elements. In case dome span increases heights of transition and exterior supporting elements increase with the same ratio and dimensions for preventing stresses at the springing levels as one to ten rate of dome span.

Güngör (1988) divides Ottoman dome architecture into three main categories according to their dome-supporting systems in his work on Mimar Sinan domes. These

are the square-based sub-structured supporting systems, hexagonal-based sub-structured supporting systems, and octagonal-based sub-structured systems. The square-based systems are categorized under five titles as the domes supported by walls or arches in four sides, domes supported by walls in four sides, domes supported by a wall in one side and by semi-domes in the other three sides, domes supported by walls in two sides and by semi-domes in the other two sides, and domes supported by semi-domes in four sides interior.

It may be claimed that the described dome-sub-structured supporting systems were applied in the domes of the examined baths, as well. The examined bath-domes differ from the mosque-domes in one respect that the sub-structured supporting systems of examined bath-domes have only square or octagonal bases on the interior while octagonal frame supporting systems on the exterior. *Soyunmalık* space of the men's section in Tire Tahtakale Hamamı and *sıcaklık* main space of the men's section in Tire Yalınayak Hamamı are spaces having octagonal bases interior and exterior. All of the domed-spaces apart from these are square in geometrical form. The square-based sub-structured supporting systems with two arches and two walls were applied in most of the baths that have domes in their central units and have *sıcaklık* main spaces in square plan type. It may be noted that if *ılıkılık* space consists of a main unit and a side unit, then, in the domed main unit, the direction towards the side unit is fortified by an arch and the other three directions are fortified by walls; if *ılıkılık* space consists of a main unit and two side units, then, the two directions towards the side units are fortified by arches and the other two directions are fortified by walls. If *ılıkılık*'s side unit is separated from the main unit with a wall, there are dome systems fitting on walls in four directions over this unit and all of the *halvets*. In the examined baths, while the domes with small spans are mostly fortified by four walls, and the domes with medium spans are fortified by two arches and two walls, the domes with large spans like octagonally-planned *soyunmalık* dome of the men's section in Tire Tahtakale Hamamı and the dome over *sıcaklık* main space of the men's section in Tire Yalınayak Hamamı are fortified by eight walls, and the domes with large spans like *soyunmalık* dome of the men's section in Tire Yalınayak Hamamı are fortified by an arch in one direction and by three walls in the other three directions. And the rest of the domes with large spans are fortified by four walls.

The strength of the load bearing system can be evaluated by considering the dome oblateness (dome height/dome span) and the central-angle looking at curved part

of the dome (degree). The upper side of the dome-part in  $103^\circ$  lying from the center of the dome-circle to the dome itself can be regarded as the compression area, and the lower side of it can be regarded as the tension area. The tensile area has negative effects on the masonry domes, and because of the tensile stresses, radial cracks may emerge in this area (Çamlıbel 1998; Günay 2006, p.172-188). The fact that the outer support elements (drum, frame) were prevalently applied in the medium- and large-spanned bath-domes having spans smaller than 12 meters demonstrates that the compression-tension effects were considered in domes and the outer support elements were prevalently used with structural purposes. Therefore, it may be asserted that, in Ottoman architecture, the dome-construction techniques and related architectural features were applied in the domes constructed in greater settlements, as well as, in the domes constructed in smaller settlements.

### 3.8. General Evaluation

With regards to architectural characteristics and construction techniques the obtained findings that come from the investigation of the domes can be summarized as follows:

- The domes were separated into three groups according to their spans. These are short-span *ılıklik*, *sıcaklık* main space and *halvet* domes between 0.95 and 3.45 meters, mid-span *ılıklik*, *sıcaklık* main space domes between 3.5 and 6.0 meters, and long-span *sıcaklık* main space and *soyunmalık* domes with 6.05 meters and larger dimensions.
- *Soyunmalık* domes have span between 7.25 and 12.65 meters, *ılıklik* main unit domes between 1.75 and 5.50 meters, *ılıklik* sub-unit domes between 0.95 and 2.75 meters, *sıcaklık* main space domes between 2.20 and 7.80 meters and *halvet* domes between 1.90 and 4.55 meters. Usually, *ılıklik* and *halvet* domes are in short-span domes group, *sıcaklık* main space domes in mid-span domes group and *soyunmalık* domes in long-span domes group.
- In total 79 domes were examined and they were distributed according to their spans as; 45 short-span domes, 27 mid-span and 7 long-span domes. Among the total 45 short-span domes there are; 22 *halvet*, 9 *sıcaklık* main space, 6 *ılıklik* main unit, 7 *ılıklik* sub-unit and one *aralık* dome. Among the total 27 mid-span



domes; there are 14 *halvet*, 10 *sıcaklık* main space and 3 *ılıkılık* main unit domes. In total 7 long-span domes there is one *sıcaklık* main space and there are 6 *soyunmalık* domes. Accordingly; 22 of the *halvet* domes are short-span, 14 mid-span, 9 of the *sıcaklık* main space domes are short-span, 10 mid-span and one long-span, 6 of the *ılıkılık* main unit dome are short-span, 3 mid-span, 7 of the *ılıkılık* sub-unit dome are short-span, 6 of the *soyunmalık* domes are long-span domes.

- In long-span dome examples, there are no *ılıkılık* and *halvet* domes; and among the mid-span domes and short-span domes there are no *soyunmalık* domes. Among the *soyunmalık* domes hexagonal planned Tire Tahtakale Hamamı dome (12.65 meters) has the longest span and among the *sıcaklık* main space domes hexagonal planned Tire Yalınayak Hamamı dome (7.80 meters) has the longest span.
- Dome height is, between 0.58 and 2.01 meters in short-span domes, between 1.10 and 2.81 meters in mid-span domes and between 3.15 and 5.10 meters in long-span domes. In all examined domes; Tire Yalınayak Hamamı *halvet* dome has the smallest height with 0.58 meters, Tire Eski-Yeni Hamam *soyunmalık* dome has the largest height with 5.10 meters. The height is; between 3.15 and 5.10 meters in *soyunmalık* domes all with long-span, between 0.75 and 1.77 meters in short and mid-span *ılıkılık* main unit domes, and between 0.60 and 1.01 meters in *ılıkılık* sub-unit domes all with short-span, between 0.95 and 3.51 meters in short, mid and long-span *sıcaklık* main space domes, and between 0.58 and 2.81 meters in short and mid-span *halvet* domes.
- In short-span domes, the thickness is 35 to 64 centimeters at springing level, 35 to 40 centimeters up from this level and at the dome peak; in mid-span domes the thickness is 45 to 65 centimeters at springing level, 37-60 centimeters up from this level, and 35 to 40 centimeters at the dome peak; in long-span domes the thickness is 60 to 76 centimeters at springing level, 50-60 centimeters up from this level, 35 to 40 centimeters at the dome peak. While the dome thicknesses vary at the springing level in accordance with the dome spans, the thickness is mostly between 35 and 40 centimeters at the dome peak. Long-span domes are approximately 25 centimeters thicker than the short and mid-span domes.

- The thickness at the springing level is between 60 and 76 centimeters in *soyunmalık* domes all with long-span, between 45 and 75 centimeters in long-, mid-, and short-span *sıcaklık* main space domes, between 35 and 62 centimeters in mid and short-span *ılıklik* main unit domes, between 35 and 64 centimeters in *ılıklik* sub-unit domes all with short-span, and between 37 and 72 centimeters in mid and short-span *halvet* domes.
- Depending on the span and bond type; the dome thicknesses are; minimum 35 to 40 centimeters, maximum 65 to 75 centimeters at springing levels, between 35 and 40 centimeters at the dome peak. In accordance with the bond formation with one or double brick depending on the span, the thickness at the springing level vary between 35 and 75 centimeters. Therefore, while the thickness at the springing level is minimum 35 to 40 centimeters and maximum 45 to 50 centimeters in bond types with one brick, in use of double brick the thickness is 65 to 75 centimeters at springing level, 50 to 60 centimeters up from this level by changing the bonding from double row to one row, and 35 to 40 centimeters at the dome peak.
- In all short-span (0.95-3.45 meters) domes the thickness corresponds to one brick row size, in most of the mid-span (3.5-6.0 m) domes the thickness corresponds to one brick row size and in long-span (above 6 m) domes the correspondence is to a double brick row at springing level, one brick row size at the dome peak.
- Three bond types are determined in relation to material use in the examined domes. These are; brick bond, brick/stone bond and stone bond. The brick bonds are in regular circular rows, brick/stone and stone bonds are in irregular circular rows. The brick bond system contains five different organizations. The most common ones are; “*horizontal stacking of the short side faces in places non-parallel rows*” and “*horizontal and adjacent stacking of the short side faces in parallel rows*” type of bonds. “*Horizontal and adjacent stacking of the short side faces in parallel rows*” is mostly observed in long-span domes, “*horizontal stacking of the short side faces in places non-parallel rows*” and “*horizontal stacking of long faces on the bottom for a few rows and short faces on top in parallel rows*” in mid-span domes, “*random horizontal stacking of long and short faces*” is observed in short-span domes. However, in long and mid-span

domes, the bond usually converts into “*horizontal and adjacent stacking of the short side faces in parallel rows*” bond type towards the dome top.

- The domes were commonly constructed of brick and lime mortar as binder. However, Urla Hersekzade Ahmet Paşa Hamamı men’s section *ılıklik* and northwest *halvet* dome constructed of brick and stone, *sıcaklık* main space and south *halvet* domes were constructed of stone and lime mortar as binder, and these are exceptional examples. The domes were coated with horasan plaster internally and externally.
- In the dome bonds, full bricks with approximate dimensions of 39-40 x 27-28 x 4.0-4.5 centimeters and/or 30-32 x 21-24 x 3.0-4.5 centimeters and half bricks with approximate dimensions of 21-24 x 14-16 x 3.0-4.5 centimeters are used. Horizontal and vertical joints of the same surface have widths of 1.5 to 2.5 centimeters on the inside and 3.0 to 5.0 centimeters on the outside.
- According to the examination and statical analyses of the domes it is determined that, depending on the construction techniques, there are linear relationships between dome span and height, dome span and thickness, and dome span and number of oculi. As the span increases, height, thickness and number of oculi increase in domes. In examined domes, the ratio of dome height to span is 0.42. The ratio of height to the span is determined as; 0.48 in one of the most common bond types, “*horizontal stacking of the short side faces in places non-parallel rows*” bond type; 0.40 in “*horizontal and adjacent stacking of the short side faces in parallel rows*” bond type. Although there are two different bond types, it is possible to consider that the ratio of height to the span is the same.
- In the examined domes the lighting elements are oculi, lighting cupolas, top skylights, lighting lanterns and windows. In *ılıklik* and *sıcaklık* spaces, the lighting elements are oculi placed on the dome, lighting cupola or top skylights and in *soyunmalık* spaces, lighting lanterns on the top and windows at the springing levels.
- The oculi are lighting elements formed by the organization of the bond or the placement of the terracotta elements among the bond at the dome. They are usually located on the dome in two or three circular rows, in hexagonal shape and decreasing in number. Commonly the oculi are, hexagonal, circular and star shaped.

- The width of the oculi span in long-span domes is 25 to 40 centimeters towards inside and 19 to 25 centimeters towards outside, in mid-span domes the width is 20 to 24 centimeters towards inside and 15 to 19 centimeters towards outside, and in short-span domes dimensions are 15 to 19 centimeters towards inside, 13 to 15 centimeters towards outside, with decreasing dimension as narrowing 3-5 centimeters from inside towards outside. The spans of oculi are measured uniform throughout the oculi rows, until the top. Circular oculi are constructed with terracota pipes, however pentagonal, hexagonal or star shaped oculi are formed with organization of the brick bond. Openings are provided with the use of half and full bricks and the geometry is fixed with horasan plaster.
- The examples on which the oculi are designed in different alignments for decorative purposes are; Tire Tahtakale Hamamı, Yalınayak Hamamı, Hekim Hamamı and Urla Hersekzade Ahmet Paşa Hamamı. Oculi organizations with different size and forms are sampled in, Urla Kamanlı Hamamı, Seferihisar Büyük Hamam, Ulamış Hamamı, Tire Yalınayak Hamamı, Hekim Hamamı and Eski- Yeni Hamam.
- In square planned large scale spaces, light cupolas that were constructed with bricks were arranged in the middle of the dome with a shape of oblate hemispherical lid and oculi formed by terracota pipes were placed on these cupolas in two or three rows, with the purpose to increase the amount of light penetration from the dome to the space. In domes with light cupolas, the organizations with different size and shapes are observed in Urla Kamanlı Hamamı, Seferihisar Büyük Hamam, Ulamış Hamamı, Tire Yalınayak Hamamı, Hekim Hamamı and Eski-Yeni Hamam. These organizations can be classified as; organization of oculi in ternary, double or single order with decorative purposes in Tire Tahtakale Hamamı; in spiral organization starting from springing level towards top in Tire Yalınayak Hamamı; organization of oculi in segmented domes in Tire Hekim Hamamı; and construction of eight-strand star with horasan plaster and organization of oculi in edge of each strand in Tire Tahtakale Hamamı. Different geometrical organizations observed in Tire Yalınayak and Tire Hekim Hamamı domes and decorative organizations observed in Tire Tahtakale Hamamı can be evaluated as particular applications unusual for Tire baths.

- In *soyunmalık*, in addition to the lighting lantern at the top of dome, in Düzce Hamamı and Tire Yalınayak Hamamı, depressed pointed arched windows are located at the springing levels.
- The domes with oculi commonly have span between 2.0 to 4.5 meters and the span should at least be 2.0 meters in order to use oculi in dome structure. Apart from the long-span Tire Yalınayak Hamamı men's section *sıcaklık* main space dome with 7.80 meter span, none of the long-span domes have oculi. Due to dome span and number of oculus relationship, in a dome with 2.0 meters span 5 oculi are located; in a dome with 5 m span there are 48 oculi.
- Concerning the dome construction techniques and bearing systems, it can be seen in the examined domes that the dome structure is simple, its geometry is regular, and its supporting manner to the substructure is uniform through the periphery.

In the content of this thesis, the relationship between architectural characteristics and construction techniques of domes were investigated by means of using "simple linear regression" as a statistical model. The findings that are outcome of statistical analyses can be arranged as follows:

A positive (linear) correlation was determined at the domes between dome span - height - bond type (*horizontal stacking of the short side faces in places non-parallel rows* and *horizontal and adjacent stacking of the short side faces in parallel rows*); span - height; span - oculi number and row in the simple linear regression analyses. In case span increases the height of dome, the row and number of oculi increase. In examined domes, the ratio of dome height to span is 0.42. The ratio of height to the span is determined as; 0.48 in one of the most common bond types, "*horizontal stacking of the short side faces in places non-parallel rows*" bond type; 0.40 in "*horizontal and adjacent stacking of the short side faces in parallel rows*" bond type. Although there are two different bond types, it is possible to consider that the ratio of height to the span is the same. The ratio of detected a positive (linear) correlation between dome span and dome height can be acceptable as a close value with determined the proportional relationship (0.30-0.38,8) whose analysis was made previously on the Mimar Sinan domes (Çamlıbel 1998).

In the examined domes, however, a relationship could not be identified between dome span - thickness, dome span - the height of transition elements to the dome, dome

span - the height of the dome exterior supporting element and dome span – the type of transition element. It is also seen that different types of transition element to dome such as pendentives, tromps, Turkish triangles were arranged in domes that have the same span and height.

The determined relationship ratio between dome span – dome thickness, dome span - the height of transition element to dome, and dome span - the height of dome exterior supporting element is approximately 1:12 and this ratio is the same with the mathematical ratio determined in consequence of structural analyses on domes.

The general findings obtained as a result of this study on 17 baths and 79 domes are given as follows:

- **Construction technique:** the domes were commonly constructed of brick and lime mortar as binder. Flush joints, horizontal and vertical, have 1.5-2.5 centimeters in interior width while 3-5 centimeters in exterior width in the brick dome bond. The surfaces were covered with horasan plaster 1.5-2 centimeters in interior thickness and 3-5 centimeters in exterior thickness.

Circular shaped oculi were constructed with terracotta pipes while the other shaped oculi (pentagonal, hexagonal, star, octagonal, etc) were formed with brick bond. Instead of a few exceptional samples in all domes lighting element was arranged on the top of dome for diminishing compression forces coming from loads. This lighting element on the top were formed by stacking long surfaces of the half-bricks side by side in perpendicular order to the horizontal plane in the dome thickness.

Dome thickness at the springing level is in use of double bricks, one and a half brick up from this level and one brick at the dome peak by changing the bonding from double row to one row. The section of dome was raised at the springing level in which there are intensive tensile forces, whereas the section of dome at the dome peak was decreased for diminishing dome loads and thus lightening compression forces.

- **Brick bond type:** The type of common brick bond is horizontal stacking of the short side faces in places non-parallel rows. However, the bond type of *soyunmalık* and *sıcaklık* main space domes is horizontal and adjacent stacking of the short side faces in parallel rows.
- **Dome base:** The domes were raised above a circular base 25-30 centimeters in interior height arranged on the flesh walls 70-75 centimeters in thickness. The

long span *soyunmalık* and *sıcaklık* main space domes and mid-span *ılıklik*, *sıcaklık* main space and *halvet* domes were supported by an octagonal exterior supporting element (drum) on the exterior. On the other hand, short span *ılıklik* and *halvet* domes were settled directly on the flesh walls.

- **Transition element to dome:** The pendentives were mostly applied in the domes as transition element to dome; however, the squinches, Turkish triangles, and plain triangles were also observed as applied transition elements in the bath spaces.
- **Profile:** The domes have semi-circular profiles and plain surfaces extensively.
- **Oculus shape:** Oculi are generally in hexagonal shaped. However, circular, pentagonal and star shaped oculi were used as together for the decorative purposes. In addition, there is a relationship between dome span and oculus size. Dome span increases as the oculus size increases. Oculi arranged on the light cupolas are in hexagonal shaped, smaller sized than the oculi placed on the dome surfaces and in a circular row.
- **Oculi row and number:** At the mid span domes (3.05-6.00 m) oculi were arranged as either three row or more higher in number while at the short span domes having a span of 2 - 3 meters oculi were arranged as either one or two rows. Oculi were places as decreasing in number from the springing level towards dome top. While there was arranged one oculus or a top skylight on the dome top in the short span *ılıklik* domes which have a span shorter than 2 meters, in the *ılıklik*, *sıcaklık* main space and *halvet* domes which have a span of 2-4.5 meters there were arranged one, two or three oculi rows related to dome span. The span should be at least 2 meters to be able to use oculi on the dome surface and also at least 3 meters to be arranged 3 oculi rows on the dome surfaces. Accordingly, in the dome with 2 meters span 5 oculi were arranged, in the dome with 4.5 meters span 40 oculi were arranged.
- **Light cupolas:** The use of a light cupola at the top of dome in most of the mid span domes stands out as a common application.

Regarding the relationship between span and height the bath domes located in the capital cities of Ottoman period (Haseki Hürrem Sultan Hamamı located in İstanbul; Tahtakale Hamamı, Beylerbeyi Hamamı, Topkapı Hamamı located in Edirne) and the bath domes located in small cities and villages have the same ratio, the ratios of which

are between 0.30-0.42 in the long span domes of *soyunmalık* and *sıcaklık* main spaces while between 0.42-0.52 in the mid-span and short span domes of *ılıklik*, *sıcaklık* main space and *halvet* domes. Moreover, the thicknesses are almost the same in the section of all bath domes at the springing levels. On the other hand, the domes of capital cities differentiates from the small city and village bath domes by the ornamental and geometrical arrangements on their surfaces and/or transition elements to dome such as segmented surfaces, floral decorative, muqarnasses, etc. The number of oculi and the oculi rows arranged in the all domes are related to dome span in all short, mid and long span *soyunmalık*, *ılıklik*, *sıcaklık* main space and *halvet* domes. One or two oculi rows were arranged in short span *ılıklik* and *halvet* domes while three or four oculi rows in the mid and long span domes of *ılıklik*, *sıcaklık* main space and *halvet* domes of capital cities bath domes and thus is similar to the small cities bath domes. A light cupola was arranged at the top of domes as in common use.



## CHAPTER 4

### CONCLUSION

Ottoman Baths, which are the subject of examination, are located in the centers of Urla, Seferihisar, and Tire districts and nearby village settlements. They are social and public structures which provide significant information about both the Ottoman bath architecture of the era and regional architectural characteristics, construction techniques and utilization of materials. Domes constructed with different dimensions and organizations juxtaposed to each other provided a dynamic character to the bath mass that is modest in exterior size and appearance. In addition, they helped to achieve a unique spatial atmosphere with lighting effects provided by placement of lighting elements on the superstructure from the interior.

The purpose of this study is to investigate architectural characteristics and construction techniques of domes in a group of Ottoman baths to expand and improve the technical information for the purpose of conservation works on domes. The current literature includes improved structural analysis studies based on the finite element methods for either a single or a group of domes. These studies were intended for structural behavior simulations of domes under seismic loads. The lack of knowledge and studies in literature on architectural characteristics and construction techniques of domes and the relationship between each other increases the importance of this thesis. In this study, subsequent examination and then documentation of architectural characteristics and construction techniques of bath domes with field surveys primarily a catalogue study that contains the investigation of architectural and construction features of the domes in detail were prepared. Furthermore, the catalogue data were evaluated by means of using statistical analyses of simple linear regressions in order to seek the relation network of embodying information.

In the scope of this study, architectural characteristics (dome span, dome height, the order and shape of oculi placed on the dome, transition elements to dome, exterior supporting elements) and construction techniques (thickness, bond type) of domes in a group of Ottoman baths were examined and the relationship network (span-height, span-thickness, bond type-span-height, span-oculi numbers and rows, span- height and

type of transition elements to dome, and span-height of exterior supporting elements) were investigated.

As the results of investigation and analyses, the relationships between architectural characteristics and construction techniques can be determined as follows;

- A positive (linear) correlation was determined at the domes between dome span – height, and oculi number and row; whereas, a mathematical ratio between 1:10 and 1:12 was determined between dome span – dome thickness, dome span - height of transition element to dome, and dome span - height of dome exterior supporting element. This ratio between dome span - dome thickness, height of transition element and exterior supporting element was defined as the same with the mathematical ratio of 1:12 between dome span and dome thickness at the springing level of dome determined by Fontana (1674) in consequence of studies on domes, and applied in the construction of Santa Margherita Cathedral dome in Montefiascone-Italy, which was also built by Fontana (Manzanares 2003).
- The ratio of dome height to span, in the other word called as oblateness of the dome, was determined between 0.40 and 0.48. In the examined domes, the oblateness ratio can be acceptable as a similar value with determined proportional relationship of 0.30-0.52 (Mimar Sinan Eserleri 2011) in the domes of Haseki Hürrem Sultan Bath in İstanbul, Tahtakale, Beylerbeyi and Topkapı Baths in Edirne; whereas, it is more higher than the oblateness ratio of 0.30-0.38,8 (Çamlıbel 1998) at the domes of Üsküdar Mihrimah, Kara Ahmet Paşa and Şehzade mosques in İstanbul which were built by Mimar Sinan. This case is on account of the domes of aforementioned mosques being depressed profiles and the examined domes being semi-circular profiles.
- The dome thicknesses are minimum 35-40 cm, maximum 65-75 cm at springing levels depending on dome span and bond type, while the same in all cases between 35 and 40 cm at the dome peak. The thickness at the springing level vary between 35 and 75 cm in accordance with the bond formation with one or double bricks depending on the span. That thickness of the springing level of the dome is higher than the top of the dome can be evaluated as a measurement taken against the tension forces at the springing level while an application in order to reduce the pressure at the top of the dome (Çamlıbel 1998).

- In the examined domes three different bond types were determined depending on the use of material. These bond types are; brick bond, brick / stone bond and stone bond. The brick bonds were arranged as regular circular rows whereas brick / stone and stone bonds were arranged as irregular circular rows. The brick bonds contain five organizations. The most common ones are; “horizontal stacking of the short side faces in places non-parallel rows” and “horizontal and adjacent stacking of the short side faces in parallel rows” type of bonds. In the domes examined, the ratio of dome height to span is 0.42. The ratio of height to the span was determined as 0.48 in one of the most common bond types, “horizontal stacking of the short side faces in places non-parallel rows” bond type, while 0.40 in the other one of “horizontal and adjacent stacking of the short side faces in parallel rows” bond type.
- The bricks used in the dome bonds are generally in the approximate dimensions of 30-32 x 21-24 x 3-4.5 cm as whole bricks and in the approximate dimensions of 21-24 x 14-16 x 3-4.5 cm as half bricks. However, bricks with dimensions of 39-40 x 27-28 x 4-4.5 cm in Tire Tahtakale Hamamı, 34-35 x 20-22 x 4-4.5 cm in the Tire Karagazi Hamamı and 23-24 x 16-17 x 6-6.5 cm in Sığacık Kaleiçi Hamamı dome bonds varied from the bricks used in the other bath domes.
- In all cases, both vertical and horizontal joints were used as flush joints and all interior and exterior surfaces were coated with horasan. Both vertical and horizontal flush joints were determined as having dimensions between 1 and 2.5 cm in width on the interior surfaces in the bond type of “horizontal and adjacent stacking of the short side faces in parallel rows” seen in mid-span and long-span domes. Regular circular brick rows and thin joints at the domes built of this bond type are considered as built by means of moulds. In the examples with the other bond types, the width of flush joints was determined in the dimensions of 3-5 cm as the same with brick thickness. That the same dimensions of joint width with brick thickness are thought that domes can be defined as shell-type structures which can be modeled with uniform elements.
- It may be said that the use of oculi on the domes involves structural features in order to lighten dome loads and spatial features by means of light and shadow effects. The various geometric patterns arranged on the domes are creating ornamental effects at the dome and space. The arrangements of oculi just at the

compression zone and not using oculi at the tension zone can be appraised as a structural organization for the purpose of lightening dome loads.

- The width of the oculi span has interior variable dimensions of between 15 and 30 cm according to the dome span with decreasing dimension narrowing 3-5 cm from interior towards exterior. The extending dimension of oculi which are arranged on the curved surface of domes from exterior towards interior provides natural light diffusing to the bathing spaces as homogenous. The circular shaped oculi were formed by the placement of the terracotta elements among the bond, whereas star and polygonal shaped oculi by the organization of brick bond at the dome. On the domes, the oculi were used in the same geometry as well as the star and polygonal shaped oculi were also used together. In the long-span domes the oculi in different shapes were used for decorative purposes. In addition, the placement of oculi in slices made into the domes, the arrangement of oculi in geometric patterns formed on the surfaces of domes, grouped oculi as spirals, double and triple layouts were also used for decorative purposes.
- In the examined baths pendentives were widely used as transition element to dome. However, Turkish triangle, tromp, and plain triangles were also used as transition elements. It can be claimed that there is no relationship between dome span, height and the type of transition elements. Transition elements are various with the same spans and heights of domes in the same bath such as Düzce Hamamı, Kamanlı Hamamı, Tire Tahtakale Hamamı, Tire Yalınayak Hamamı and Tire Yeniceköy Hamamı. Accordingly, it can be evaluated that the height of transition elements were determined by taking into account the structural requirements, whereas the type of transition elements for the purpose of diversity in the spatial perception.
- In the mid and large-span domes, it can be claimed that exterior supporting element were used for eliminating the tension stresses at the springing level. On the other hand, it can be said that in short-span domes exterior supporting elements were not used on account of having less tensions at the springing level than mid and long-span domes and dome loads were transferred directly to the walls. In addition, it was determined that the exterior supporting element were constructed as one drum in most short, mid and long span domes with dimensions between 2.35 and 7.40 meters, whereas two drums successively in long span domes with dimensions between 7.80-12.65 meters. In the examined

baths, exterior supporting elements are generally in octagonal form. However, in all short and mid-span domes of Tire Hekim Hamami the exterior supporting elements were used in cylinder forms.

As a result, it can be stated that the examined domes were differentiated even in the same geographic region depending on local structural materials, construction techniques and construction experiences and they have their own unique construction techniques. For this reason, in interventions for the purpose of conservation in each bath, thereby its domes, protecting the unique architectural and construction features of the domes and the transfer to the future are important.

Regarding the further studies, the subject and content of this thesis can be pioneer in many ways. These ways of further studies may be determined as follows:

1. Where the relationship is weak or not seen a statistically significant relationship, multi-linear regression may be tried by adding more independent variables to the statistical model instead of simple linear regression. In this case, more domes need to be examined and to be added to the statistical analysis model. At the same time increasing the sample size can increase the model's explanatory power. Despite the increasing number of domes and variables, non-linear analysis methods can be tried if there is no a linear relationship between the variables.
2. This thesis includes only the statistical analyses and investigations of the domes in a group of Ottoman baths located in Western Anatolia. In further studies, the findings related to general bath domes can be generalized after analyzing other bath domes located in other geographic regions by using the same analyzing methods and comparing the content and findings of the investigated domes in this thesis with the other bath domes.
3. Besides the investigations regarding architectural characteristics and construction techniques of bath domes, structural behaviors under static or dynamic loads and the distribution of structural loads by using finite element methods can also be investigated. These studies provide a scientific investigation of structural properties and behavior of the bath domes.
4. Rather than bath domes, other domes of domed masonry structures such as mosque, masjid, madrasah, etc may be similarly investigated and compared with the bath domes. Thus, the similarities and differences between the domes may be determined.

## REFERENCES

- Acland, James H. 1972. *Medieval structure: the Gothic vault*. University of Toronto Press, Canada.
- Adam, Jean P. 2005. *Roman building: materials and techniques*. Taylor and Francis Group, London: Routledge.
- Akın, Himmet. 1968. *Aydinoğulları tarihi hakkında bir araştırma (Research on the history of Aydınoğulları)*. Ankara Üniversitesi, Dil Tarih Coğrafya Fakültesi Yayınları, Ankara.
- Akyıldız, Bilge. 1988. *Urla tarihi doku araştırması – koruma ve restorasyon önerileri*. Unpublished Master Thesis. Dokuz Eylül University, İzmir.
- Altın, M. 2001. The structural analysis of domes: from Pantheon until Reichstag. *Structural repair and maintenance of historical buildings*. (eds.) P.B. Lourenço, P. Roca, Portugal: 197-208.
- Arce, I. 2003. From the diaphragm arches to the ribbed vaults; a hypothesis for the birth and development of a building technique. *Proceedings of the First International Congress on Construction History*, 20-24 January 2003, Madrid: 225-241.
- Armağan, A. Münis. 1991. *Yeşil Tire*. Tire Belediyesi Yayınları, Tire - İzmir.
- Armağan, A. Münis. 1983. *Belgelerle Beylikler devrinde Tire*. Uğur Ofset Matbaacılık, İzmir.
- Armağan, A. Münis. 2003. *Devlet arşivlerinde Tire*. Bilkar Bilge Karınca Matbaacılık, Tire - İzmir.
- Aru, K. Ahmet. 1949. *Türk hamamları etüdü*. İTÜ Mimarlık Fakültesi - Doçentlik Çalışması, İstanbul Matbaacılık T.A.O., İstanbul.
- Aslanoğlu, İnci. 1978. *Tire'de camiler ve üç mescit*. METU: Faculty of Architecture 26, Ankara.
- Bakırer, Ömür. 1972. *Anadolu Selçuklularında tuğla işçiliği*. Malazgirt Armağanı, Türk Tarih Kurumu Basımevi, Ankara, 186-211.

- Bakırer, Ö. 1980. A study on the use of brickbonds in Anatolian Seljuk architecture. *METU: Journal of the Faculty of Architecture* 6 (2): 143-181.
- Bakırer, Ö. 1981. Selçuklu öncesi ve Selçuklu dönemi Anadolu mimarisinde tuğla kullanımı. *METU: Journal of the Faculty of Architecture* 1-2, Ankara.
- Bakırer, Ö. 1993. Anadolu mimarisinde taş ve tuğla işçiliği. *Başlangıcından günümüze Türk sanatı*, Ankara, 255-280.
- Bakırer, Ö. 1995. Anadolu Selçuklu mimarisinde yapı malzemeleri. IV. *Milli Selçuklu Kültür ve Medeniyeti Semineri Bildirileri – 25 - 26 Nisan 1994*, Selçuk Üniversitesi Selçuk Araştırmaları Merkezi Yayınları, Konya, 165-180.
- Bakırer, Ö. 2002. *Tuğla, ahşap ve cam: Selçuklu çağında Anadolu sanatı*. Yapı Kredi Yayınları, İstanbul, 291-308.
- Baronio, G., L. Binda, and C. Tedeschi, 1997. Thick mortar joints in Byzantine buildings: Study of their composition and mechanical behaviour. *Proceedings of the International Conference on Studies in Ancient Structures*, G. Özşen (ed.), 1997, Istanbul, Turkey, 235-244.
- Batur, A. 1970. Osmanlı camilerinde almaşık duvar üzerine. *Anadolu Sanatı Araştırmaları* 2, İTÜ Mimarlık Fakültesi, İstanbul, 135-227.
- Batur, Afife. 1974. *Osmanlı camilerinde kemer strüktür- biçim ilişkisi üzerine bir deneme (1300 - 1730)*. İTÜ: Mimarlık Fakültesi, İstanbul.
- Beckett, E. D. 1871. On the mathematical theory of domes. *Memoirs of the Royal Institute of British Architects*, 81-115.
- Bilgin, H. 2005. Sinan kubbeli yapılarında mekân örtü sistemlerinin yapısal davranışı. *Deprem Sempozyumu Kocaeli 2005*, 23 - 25 Mart 2005, Kocaeli.
- Bulsic, M. S. 2001. Peculiar stone vaults of the cathedral in Sibenik. *International Conference on Studies in Ancient Structures*, Yıldız Technical University, Faculty of Architecture, Istanbul, 487-496.
- Büyükdigan, I. 2003. A critical look at the new functions of Ottoman baths. *Building and Environment* 38: 617-633.

- Chassagnoux, A. 2001. Iranian architecture: evolution and behaviour of vaulted structures. *International Conference on Studies in Ancient Structure*, Yıldız Technical University, Istanbul, 315-324.
- Cowan, Henry J. 1977. *Structure in the Ancient World*, in: *The Master Builders*, John Wiley & Sons, Inc, New York: Wiley.
- Cowan, Henry J. 1985. *The master builders: a history of structural and environmental design from ancient Egypt to the nineteenth century*. Robert E. Krieger Publishing Company, Malabar, Florida.
- Creswell, K. A. Cameron. 1989. *Early Muslim architecture*. Aldershot: Scolar Press.
- Croci, Giorgio. 1998. *The conservation and structural restoration of architectural heritage*. Southampton: Computational Mechanics Publications, USA.
- Curl, James Stevens and John J. Sambrook, 1999. *A dictionary of architecture*. Oxford University Press.
- Çakmak, Canan. 2002. *Tire hamamları*. Kültür Bakanlığı Yayınları, Ankara.
- Çamlıbel, Nafiz. 1998. *Sinan mimarlığında yapı strüktürünün analitik incelenmesi*. Yıldız Teknik Üniversitesi Basım-Yayın Merkezi Matbaası, İstanbul.
- Çizer, Özlem. 2004. *Investigation of lime mortar characteristics for the conservation of the Ottoman baths in Seferihisar-Urla region*. Unpublished MSc Thesis, İzmir Institute of Technology, İzmir.
- D'Ayala, D. 1993. Analytical method for the assessment of the safety levels of domes. *Third International Conference on Studies, Repairs and Maintenance of Historical Buildings*, Published by Computational Mechanics Publications in Southampton, Boston, 347-355.
- DeLaine, J. 1990. Structural experimentation: The lintel arch, corbel and tie in Western Roman architecture. *World Archaeology* 21(3): 407-424.
- Elam, Kimberly. 2001. *Geometry of design: studies in proportion and composition*. New York: Princeton Architectural Press.



- Escrig F. and J. P. Varcарcel, 1995. Influence of constructive systems in the structural performance of ancient domes. *Structural Studies, Repairs and Maintenance of Historical Buildings IV*, Vol 2 Dynamics, Repairs and Restoration, C. A. Brebbia (ed.), Computational Mechanics, Crete-Greece, 179-188.
- Ettinghausen, Richard and Oleg Grabar 1987. *The art and architecture of Islam / 650-1250*. New Haven and London: Yale University Press.
- Eyice, S. 1960. İznik'te Büyük Hamam ve Osmanlı devri hamamları hakkında bir deneme. *Tarih Dergisi* 11(5): 99-120.
- Fahjan, Y. M. and H. Keypour, 2006. Effects of dome system on the seismic behaviour of Ottomans historical structures. *Structural Analysis of Historical Constructions*, P.B. Lourenço, P. Roca, C. Modena, and S. Agrawal (eds.), 6-8 November 2006, New Delhi, India, 1607-1614.
- Fielden, Bernard M. 2001. *Conservation of historic buildings; structural elements I: beams, arches, vaults and domes*. Architectural Press, Oxford, 37-49.
- Fletcher, Banister. 1996. *Sir Banister Fletcher's a history of architecture*, edited by Dan Cruickshank, Architectural Press, London.
- Fontana, Carlo. 1694. *Regole per le Cupole Semplici, & effeti di esse, e dell'altre doppie*. II Tempio Vaticano e sua origine, Rome: Stamperia di Gio. Francesco Buagni, Italy.
- Fusco, A. C. and M. Villanni, 2003. Pietro da cortona's domes between new experimentations and construction knowledge. *Proceedings of the First Intenational Congress on Construction History*, Madrid, 579-591.
- Günay, Reha. 2006. *Mimar Sinan; Sinan yapılarının mimari analizi*. Yapı - Endüstri Merkezi Yayınları, 172-188.
- Güngör, I. H. 1988. The dome in Sinan's works. *Proceedings of the IASS-MSU Intenational Symposium on Domes*, Istanbul, 61-92.
- Hager, H. 1973. La crisi statica della cupola di Santa Maria in Vallicella in Roma e i rimedi proposti da Carlo Fontana, Carlo Rainaldi e Mattia de Rossi. *Commentari, Rivista di critica e storia dell'arte* 24(4): 300-318.

- Hager, H. 1975. Die kuppel des domes in Montefiascone. Zu einem borrominesken experiment von Carlo Fontana. *Römisches Jahrbuch für Kunstgeschichte* 15, 144-168.
- Harvey, John. 1972. *Conservation of buildings "Part two: Craftsmanship and materials"*, John Baker, London.
- Hasol, D. 1998. Kubbe. *Ansiklopedik Mimarlık Sözlüğü*. 7. Baskı, İstanbul, 280.
- Heyman, Jacques. 1977. *Equilibrium of shell structures*. Oxford University Press, Oxford.
- Heyman, J. 1967. On shell solutions of masonry domes. *International Journal of Solids and Structures* 3(1967): 227-241.
- Hidaka, K., T. Aoki, and S. Kato, 1993. Structural stability and profile in the dome of Santa Maria del Fiore, Florence. *Structural Repair and Maintenance of Historical Buildings*, Florence: 211-220.
- Huerta Fernández, Santiago. 1990. *Diseño estructural de arcos, bóvedas y cúpulas en España, ca. 1500- ca. 1800*. PhD, Universidad Politécnica de Madrid., Escuela Técnica Superior de Arquitectura, Madrid.
- Huerta, S. 2001. Mechanics of masonry vaults: The equilibrium approach. *Historical Constructions*, P.B.Lourenço and P.Roca (eds.), Guimaraes, 47-69.
- Huerta, S. 2007. Oval domes: History, geometry and mechanics. *Nexus Networks Journal* 9(2): 211-248.
- Ignatakis, C., K. Stylianidis, and E. Stavrakakis, 1993. Design of interventions in domes: The importance of consideration of cracking. *Structural Repair and Maintenance of Historical Buildings*, 225-265.
- Kahya, Yegan. 1992. *İstanbul Bizans mimarisinde kullanılan tuğlanın fiziksel ve mekanik özellikleri*. Unpublished Ph.D. Thesis, İstanbul Technical University, İstanbul.
- Kanetaki, E. 2004. The still existing Ottoman hamams in the Greek territory. *METU JFA*, 1-2(21): 81-110.

- Kaplan, Ç. D., F. Murtezaoğlu, and G. Saygı, 2007. Tire Tahtakale Hamamı'nın tanıtılması ve değerlendirilmesi. *Yayınlanmamış Araştırma Raporu*, İYTE Mimari Restorasyon Bölümü, İzmir.
- Karaesmen, E. and A. İ. Ünay, 1988. A study of structural aspects of domed buildings with emphasis on Sinan's mosques. *Proceedings of the IASS-MSU International Symposium on Domes*, Istanbul, 93-104.
- Karaesmen, E. 1993. A study of the Sinan's domed structures. *Structural Repair and Maintenance of Historical Buildings*, 201-210.
- Kobell, F. 1855. Beitrag zur Statik der Gewölbe. *Allgemeine Bauzeitung*, Bd. 22, 92-110.
- Kolay, İlknur A. 1999. *Batı Anadolu 14. yüzyıl Beylikler mimarisinde yapım teknikleri*. AKM, Ankara.
- Kuban, D. 1980. Architecture of the Ottoman period. *The Art and Architecture of Turkey*, E. Akurgal (ed.), Oxford, 140-141.
- Lau, Wanda W. 2002. *Equilibrium analysis of masonry domes*. Unpublished MSc Thesis, Michigan State University.
- Lopez Manzanares, G. 2003. The XVII<sup>th</sup> century: Carlo Fontana's expertises. *Proceedings of the First International Congress on Construction History*, Madrid, 1307-1320.
- Mark, Robert, ed. 1993. *Architectural technology up to the scientific revolution*. The MIT Press, New Liberal Arts Series, Cambridge – London, England.
- Menditto, G. and F. Betti, 1993. Analysis and mathematical simulation of the urbino cathedral dome. *Third Structural Repair and Maintenance of Historical Buildings*, 221-231.
- Mimar Sinan Eserleri 2011. Mimari\_cizimler/Istanbul Haseki Camii ve Hamami. <http://mimarsinanerleri.com> (accessed July 11, 2011).

- Mozo, A. L. 2003. Extradomed vaults in the monastery of el Escorial: The domes at the church towers. *Proceedings of the First International Congress on Construction History*, Madrid, 1321-1326.
- Mungan, I. 1988. On the structural development of the Ottoman dome with emphasis on Sinan. *Proceedings of the IASS-MSU International Symposium on Domes*, Istanbul, 105-114.
- Mungan, I. 2009. Erken Ortaçağ'ın şaheseri Ayasofya'yı örten strüktürün güçlendirilmesi için bir konsept. *Uluslararası Katılımlı Tarihi Eserlerin Güçlendirilmesi ve Geleceğe Güvenle Devredilmesi Sempozyumu-2*, Diyarbakır, 347-365.
- Önge, Yılmaz. 1995. *Anadolu' da XII. – XIII. yüzyıl Türk hamamları*. Vakıflar Genel Müdürlüğü Yayınları, Ankara.
- Önge, Y. 1998. Anadolu'da Türk hamamları hakkında genel bilgiler ve Mimar Sinan'ın inşa ettiği hamamlar. *Mimarbaşı Koca Sinan Yaşadığı Çağ ve Eserleri 1*, Vakıflar Genel Müdürlüğü Yayınları, İstanbul, 403-428.
- Özer, B. 1987. The architect of domed mosques as a master of pluralism. *Environmental Design: Journal of the Islamic Environmental Design Research Centre 1-2 (1987)*, Attilio Petruccioli (ed), 146-155.
- Özer, B. 1988. Sinan: The architect of domed mosques as a master of pluralism. *Proceedings of the IASS-MSU International Symposium on Domes*, Istanbul, 1-18.
- Reyhan, K., B. İpekoğlu, and H. Böke, 2010. Osmanlı hamam kubbelerinde malzeme kullanımı-açıklık-yükseklik-kalınlık arasındaki ilişkilerin incelenmesi. *5.Ulusal Yapı Malzemesi Kongresi ve Sergisi; Kongre Bildirileri*, İstanbul, 409-420.
- Reyhan, K. and B. İpekoğlu, 2006. Investigation of construction techniques and materials in a group of Ottoman baths. *Structural Analysis of Historical Constructions*, P.B. Lourenço, P. Roca, C. Modena, and S. Agrawal (eds.), 6-8 November 2006, New Delhi, India, 159-167.
- Reyhan, K. and B. İpekoğlu, 2004. Osmanlı dönemi bir grup hamam yapısında malzeme kullanımı. *2.Ulusal Yapı Malzemesi Kongresi ve Sergisi; Kongre Bildirileri*, İstanbul, 482-493.

- Reyhan, Kader. 2004. *Construction techniques and materials of the Ottoman period baths in Seferihisar – Urla region*. Unpublished MSc Thesis, İzmir Institute of Technology, İzmir.
- Robison, E. C. 1989. A structural study of the Michelangelo and della porta designs for the St. Peter's Dome. *Structural Repairs and Maintenance of Historical Buildings*, C.A. Brebbia (ed.), Computational Mechanics Publications, Southampton, Boston, 23-31.
- Roca, P. 2001. Analysis of Gothic structures. *2<sup>nd</sup> International Congress on Studies in Ancient Structures*, Yıldız Technical University, Istanbul, 291-300.
- Süreyya, Mehmed. 1996. *Sicill-i Osmani: Osmanlı ünlüleri*. Tarih Vakfı Yurt Yayınları, İstanbul.
- Turan, M. 1993. Domes and supports: structural vulnerability of masonry shells. *Third International Conference on Structural Studies, Repairs and Maintenance of Historical Buildings*, C.A. Brebbia (ed.), R.J.B. Frewer, Computational Mechanics Publications, Southampton, Boston, 339-346.
- Uğurlu, Elif. 2005. *Characterization of horasan plasters from some Ottoman baths in İzmir*. Unpublished MSc Thesis, İzmir Institute of Technology, İzmir.
- Uluengin, Fatin, Bülent Uluengin, and M. Bengü Uluengin, 2001. *Classic construction details of Ottoman monumental architecture*, Yem Yayınları, Istanbul.
- Yavuz, Aysıl T. 1983. *Anadolu Selçuklu mimarisinde tonoz ve kemer*. Kelaynak Yayınları, Ankara.
- Yavuz, A. T. 2002. Anadolu Selçuklu mimarisinin yapı özellikleri. *Selçuklu Çağında Anadolu Sanatı*, Yapı Kredi Yayınları, İstanbul, 271-290.
- Yorulmaz, M. and Z. Ahunbay, 1986. Sinan camilerinde taşıyıcı sistem ve yapım teknikleri. *II. Uluslararası Türk-İslam Bilim ve Teknoloji Tarihi Kongresi*, İTÜ, İstanbul.

## APPENDIX A

### CATALOGUES

- Catalogue No: 1. Tire Tahtakale Hamamı  
Catalogue No: 2. Tire Hekim Hamamı  
Catalogue No: 3. Tire Şeyh Hamamı  
Catalogue No: 4. Tire Mehmet Ağa Hamamı  
Catalogue No: 6. Tire Eski-Yeni Hamamı  
Catalogue No: 7. Tire Yalınayak Hamamı  
Catalogue No: 8. Tire Yeniceköy Hamamı  
Catalogue No: 9. Ulamış Hamamı  
Catalogue No: 10. Düzce (Hereke) Hamamı  
Catalogue No: 11. Seferihisar Büyük Hamam  
Catalogue No: 12. Seferihisar Küçük Hamam  
Catalogue No: 13. Sığacık Kaleiçi Hamamı  
Catalogue No: 14. Urla Hersekzade Ahmet Paşa (Çifte) Hamamı  
Catalogue No: 15. Urla Kamanlı (Yahşi Bey) Hamamı  
Catalogue No: 16. Urla Rüstem Paşa Hamamı  
Catalogue No: 17. Urla Özbek Köyü Hamamı

## Catalogue No: 1 – Construction Name: Tire Tahtakale Hamamı

### 1. Construction Date

The *hamam* has no inscription. According to the 845 H. / 1442 A.D. record of foundation charter, the construction was built by Halil Yahşi Bey, a commander of Murad II. (Akin 1968, p.84; Armağan 1983, p. 7 and 2003, p.299; Çakmak 2002, p. 51). It is stated that among the buildings which are located around the *hamam*, *khans*, shops and the Yeşil İmaret Mosque are also counted in the foundation's property according to the General Directorate of Pious Foundations archive records given as the source by A. M. Armağan. Based on the records of the Foundation, the *hamam* is suggested to have been built between 1426 and 1442 (A.D.) when Halil Yahşi Bey was governor of the sanjak of Tire (Armağan 1983, p. 7 and 2003, p.299; Çakmak 2002, p. 51).



Figure A.1. Tire Tahtakale Hamamı, the general view of superstructure (2008).

### 2. Plan Characteristics

The building is a double *hamam* consisting of two sections as the men's and the women's. The men's section is located in the east part of the bath, while the women's section is located in the west. The superstructure of the women's section is lost today due to a residential structure being built on it. The men's section is composed, in a plan organization from south to north, an octagonal planned *soyunmalık*, rectangular planned *aralık*, *ılıkık*, cross shaped *sıcaklık* main space consisting of three-iwans, and two *halvets*. In addition, in the west part there is a rectangular planned water reservoir in the common uses of the men's and the women's sections and the rectangular planned *keçelik* (felting space) juxtaposed to the men's section is located in

the east. *Soyunmalık*, *aralık*, *tıraşlık*, the main unit of *ılıklik* and *sıcaklık* main space, the north iwan, and two corner *halvets* were covered with a dome while the rectangular planned iwans were covered with half-domes. The men's section can be evaluated in the plan type of cross shaped four-iwans and corner *halvets* (Eyice 1960), but here there are three iwans.

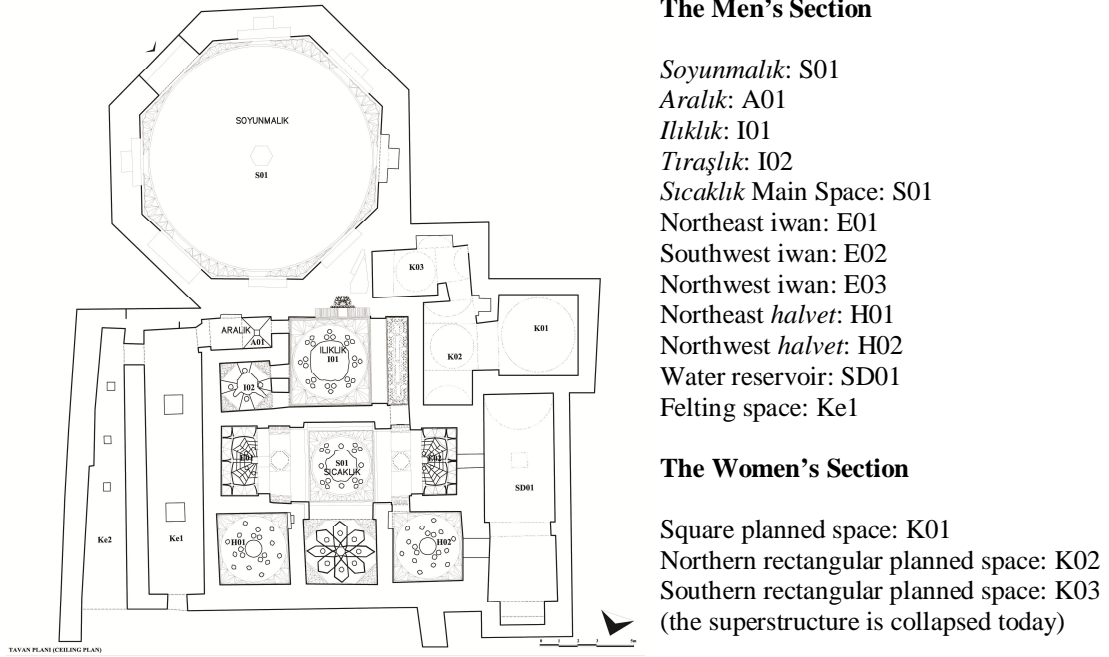

Figure A.2. Tire Tahtakale Hamamı, Plan (İYTE\_from the archive of the department of Architectural Restoration. Plan drawing was prepared during the studio work named “RES 502 Design in Architectural Restoration II” in the spring term of 2006-2007 education semesters).

### 3. Definition of Domes

#### *Soyunmalık* Dome (S01)

*Soyunmalık* dome covers the octagonal space with the edge lengths ranging from 4.86 - 5.50 m. Dome span of depressed pointed profiled dome has 12.65 m interior dimensions and dome height has 4.93 m dimensions. Thickness of the dome at the springing level is 76 cm and at the top of the dome 69 cm. In the center of the dome, there is a lighting lantern which is hexagon-shaped, and each edge of the lantern is 60 cm. Transition to the dome was provided with Turkish triangles 1.21 m in height. In this section, the pointed arch profiled windows were located 60 cm in width. The dome was raised above a circular base 30 cm in interior height while supported by an octagonal drum with 1.03 m in exterior height.





Figure A.3. Tire Tahtakale Hamamı, interior and exterior views of *soyunmalık* dome (taken from the archive of the department of Architectural Restoration – İYTE, 2007).

**Construction technique:** *Soyunmalık* dome was constructed with brick and lime mortar as binder. Now, the dome is plastered interior while coated with traditional tiles on the exterior. The plaster interior and the coating of traditional tiles exterior were renovated in the rehabilitation of dome done in 1998. The bricks used in the bond are in the dimensions of 39-40 x 27-28 x 4-4.5 cm, 30-31 x 23-24 x 4-4.5 cm as whole bricks and 23-24 x 14-15 x 4-4.5 cm as half bricks. In the original bond, both vertical and horizontal flush joints have dimensions between 1.5 and 2.5 cm in interior width.

**Bond type:** Horizontal and adjacent stacking of the short side faces in parallel rows.

**Lighting elements: Lighting lantern on the top, windows at the transition zone**

**Construction technique:** Lighting lantern was formed with an octagonal frame at the top of dome and with raising the frame by means of brick bond and placing glass surfaces with an octagonal form on the frame. Octagonal frame was arranged by stacking the long surfaces of the bricks in a horizontal line side by side and in perpendicular order to the horizontal plane in the dome thickness. Between the bricks forming the octagonal frame and the bricks stacked in radial order towards the center of the dome forming the dome thickness were filled with lime mortar including brick pieces and dust. The windows arranged among Turkish triangles in the transition zone are the depressed pointed arched openings.

**Volume:** Depressed pointed

**Profile:** Depressed pointed arc

**Center number:** 2

**Distance between two centers:** 58 cm

**Center height:** 6.10 m

**Dome span:** 12.65 m

**Impost height (dome height):** 4.93 m

**Dome thickness:** 0.76 m

**Impost line:** Raised

**Center - impost relation:** Impost line is 1.17 m higher than central line

**Impost - wall relation:** Impost is 41 cm from wall plane to the interior side

**Dome height / Dome span, Ratio:** 4.93 m / 12.65 m, 0.39

**Dome thickness / Dome span, Ratio:** 0.76 m / 12.65 m, 0.06

**Height of transition element / Dome span, Ratio:** 1.21 m / 12.65 m, 0.09

**Height of exterior supporting element / Dome span, Ratio:** 1.03 / 12.65, 0.08

#### ***Aralık* dome (A01)**

*Aralık*, rectangular planned space with 1.61 x 3.27 m interior dimensions, was covered with a barrel vault in the east and with a square pyramidal dome in the west. The dome was settled directly on the walls. The square pyramidal profiled dome has an interior span with 1.55 m and a height with 1.10 m. Thickness of the dome at the springing level is 60-65 cm and at the top of the dome 52-55 cm. In the middle, on the top of dome there is a 45x45 cm square planned top skylight opening and on the northeast and northwest surfaces of the square pyramidal dome there are hexagonal shape oculi in binary orders with a one row. The oculi are in a form having opening with 24 cm interior while 14 cm exterior size narrowing from interior towards exterior. Interior surfaces were plastered with horasan 0.5 to 1 cm in thickness.



Figure A.4. Tire Tahtakale Hamami, interior and exterior views of *aralık* dome.

**Construction technique:** The square pyramidal *aralık* dome was constructed with brick and lime mortar as binder. The dome was covered with horasan plaster 1-1.5 cm in thickness interior while 3-5 cm exterior and coated with a thick layer of lime mortar 10-15 cm in thickness including small and large pieces of slate stones, bricks and tiles with covering thick layer with traditional tiles overlapped. The bricks used in the bond are in the dimensions of 39-40 x 27-28 x 4-4.5 cm, 30-31 x 23-24 x 4-4.5 cm as whole bricks and 23-24 x 14-15 x 4-4.5 cm as half

bricks. The flush joints, both vertical and horizontal, have dimensions between 1.5 and 2.5 cm in width interior, while between 3 and 5 cm on the exterior.

**Bond type:** The bond type is brick bond. Along the raised surfaces of the pyramidal dome the bricks were stacked overlapping each other in radial order towards the centre of the cross-section of dome square base edges at the springing zone of the dome.

**Lighting elements: Skylight on the top, oculi**

**Construction technique:** Skylight on the top was formed with a square frame at the top of dome, which was arranged by stacking long surfaces of the half-bricks side by side in perpendicular order to the horizontal plane in the dome thickness. Between the half-bricks forming the square frame and whole bricks stacked radial towards the center of the dome forming the dome thickness were filled with lime mortar including brick pieces and dust. Oculi were formed with brick bond in which the bricks were stacked long surfaces forming hexagonal openings in the dome thickness. The surfaces of the oculi were formed with lime mortar coating that included small brick pieces and plastered with horasan.

**Volume:** Truncated square pyramid

**Profile:** Inclined plane

**Pyramidal dome span:** 1.55 m

**Pyramidal dome height (distance between dome base plane and dome top):** 1.10 m

**Dome thickness:** 0.60-0.65 m

**Base plane - impost relation:** The same level

**Impost – wall relation:** Impost is flush with wall plane

**Dome height / Dome span, Ratio:** 1.10 m / 1.55 m, 0.39

**Dome thickness / Dome span, Ratio:** 0.65 m / 1.55 m, 0.41

***Ilıklık dome (I01)***

*Ilıklık*, rectangular planned space with 4.37 x 6.34 m interior dimensions, was covered with a panelled vault in the west and with a dome in the east. The depressed pointed arch profiled dome has an interior span of 4.08 m and a height of 1.88 m. Thickness of the dome at the springing level is 60-65 cm and at the top of the dome 50-53 cm. The dome, collapsed in the middle on the top part, has oculi that are in three horizontal rows and the equal-size hexagonal shape three-light eyes (oculi) opposite to each other on the curved surface of the dome. At this order, the oculi were situated in three circular rows with eight each in a row in which oculi were placed as binary in the internal and external rows while in the middle row placed in a single order. The triple layout was constituted by means of placing the binary oculi in the external and internal order of those two rows close to the one oculus in the middle row within alternating

order. The oculi are in a form having an opening with 24 cm interior while 14 cm exterior size with narrowing from interior towards exterior. Interior surfaces were plastered with horasan 0.5 to 1 cm in thickness. Transition to the dome was provided with Turkish triangles 85 cm in height. The dome was raised above a circular base 26 cm in height interior while supported by an octagonal exterior drum with 50 cm height.



Figure A.5. Tire Tahtakale Hamami, interior and exterior views of *ilıklık* dome.

**Construction technique:** *Ilıklık* dome was constructed with brick and lime mortar as binder. The dome was covered with horasan plaster 1-1.5 cm in thickness interior while 5-8 cm on the exterior. The bricks used in the bond are in the dimensions of 39-40 x 27-28 x 4-4.5 cm, 30-31 x 23-24 x 4-4.5 cm as whole bricks and 23-24 x 14-15 x 4-4.5 cm as half bricks. The flush joints, both vertical and horizontal, have dimensions between 1.5 and 2.5 cm in interior width, while between 2 and 5 cm on the exterior.

**Bond type:** Horizontal stacking of the short side faces in places of non-parallel rows.

**Lighting elements: Oculi on the curved surfaces**

**Construction technique:** Oculi, as the lighting order in *aralık* dome, were formed with brick bond in which the bricks were stacked long surfaces forming hexagonal openings in the dome thickness. The surfaces of the oculi were formed with lime mortar coating that included small brick pieces and plastered with horasan.

**Volume:** Depressed pointed

**Profile:** Depressed pointed arc

**Center number:** 2

**Distance between two centers:** 36 cm

**Center height:** 2.42 m

**Dome span:** 4.08 m

**Impost height (dome height):** 1.88 m

**Dome thickness:** 0.60-0.65 m

**Impost line:** Raised

**Center - impost relation:** Impost line is 54 cm higher than central line

**Impost – wall relation:** Impost is 21 cm from wall plane to the interior side

**Dome height / Dome span, Ratio:** 1.88 m / 4.08 m, 0.46

**Dome thickness / Dome span, Ratio:** 0.65 m / 4.08 m, 0.15

**Height of transition element / Dome span, Ratio:** 0.85 m / 4.08 m, 0.20

**Height of exterior supporting element / Dome span, Ratio:** 0.50 / 4.08, 0.12

***Tıraşlık* (the square space located at the northeast of *ıkklık* main space) dome (I02)**

*Tıraşlık* dome covers the square planned space with 2.55 x 2.70 m interior dimensions. The octagonal pyramidal profiled dome has interior span of 2.35 m and a dome height of 81 cm. Thickness of the dome at the springing level is 60-65 cm and at the top of the dome 52-55 cm. One hexagonal-shape oculus was placed with equal distance from each other on each surface of pyramidal dome, the top of which was destroyed. The oculi are shaped having 23-24 cm interior opening while 13-14 cm exterior size narrowing from interior towards exterior. Interior surfaces were plastered with horasan 0.5 to 1 cm in thickness. Transition to the dome was provided with pendentives that were decorated with muqarnas 1.23 m in height. The dome was raised above an octagonal base 25 cm in interior height while supported by an octagonal drum with 50 cm in exterior height.



Figure A.6. Tire Tahtakale Hamami, interior and exterior views of *tıraşlık* dome.

**Construction technique:** *Tıraşlık* dome was constructed with brick and lime mortar as binder. The dome was covered with horasan plaster 1-1.5 cm in thickness interior and 4-6 cm on the exterior. The bricks used in the bond are in the dimensions of 39-40 x 27-28 x 4-4.5 cm, 30-31 x 23-24 x 4-4.5 cm as whole bricks and 23-24 x 14-15 x 4-4.5 cm as half bricks. The flush joints, both vertical and horizontal, have dimensions between 1.5 and 2.5 cm in interior width, while between 2 and 5 cm on the exterior.

**Bond type:** The bond type is brick bond. Along the raised surfaces of the octagonal pyramidal dome the bricks were stacked overlapping and side by side in radial order towards the centre of the cross-sections of dome's octagonal base edges at the springing zone of the dome. The long surfaces of bricks were placed in the dome thickness while short surfaces of bricks were placed as looking at inner and outer surfaces.

**Lighting elements: Oculi on the pyramidal surfaces**

**Construction technique:** Oculi were formed with brick bond in which the bricks were stacked long surfaces forming hexagonal openings in the dome thickness. The surfaces of the oculi were formed with lime mortar coating that included small brick pieces and plastered with horasan.

**Volume:** Truncated octagonal pyramid

**Profile:** Inclined plane

**Pyramidal dome span:** 2.35 m

**Pyramidal dome height (distance between dome base plane and dome top):** 0.81 m

**Dome thickness:** 0.60-0.65 m

**Impost line:** Raised

**Base plane - impost relation:** Impost line is 25 cm higher than base plane

**Impost – wall relation:** Impost is flush with wall plane

**Pyramidal dome height / Octagonal base span, Ratio:** 0.81 m / 2.35 m, 0.34

**Dome thickness / Dome span, Ratio:** 0.65 m / 2.35 m, 0.27

**Height of transition element / Dome span, Ratio:** 1.23 m / 2.35 m, 0.52

**Height of exterior supporting element / Dome span, Ratio:** 0.50 / 2.35, 0.21

#### ***Sıcaklık* main space, middle unit dome (S01)**

*Sıcaklık* main space, middle unit dome covers the square planned space with 3.57 x 4.14 m interior dimensions. The depressed pointed profiled dome has interior span of 3.40 m and a dome height of 1.49 m. Thickness of the dome at the springing level is 60-65 cm and at the top of the dome 45-50 cm. The dome, collapsed in the middle on the top part, has oculi that are in two horizontal rows and equal-sized hexagonal shape with triple and single orders alternatively on the curved surface of the dome. At this order, the oculi were situated in two circular rows with eight each in a row in which oculi were placed as binary in the external while one in the internal row. The triple layout was constituted by means of placing the binary oculi in the external row close to the one oculus in the internal row within alternating order. The oculi are in a form having an opening 24 cm interior while 14 cm exterior size with narrowing from interior towards exterior. Interior surfaces were plastered with horasan 0.5 - 1 cm in thickness. Transition to the dome was provided with Turkish triangles 85 cm in height. The dome was raised above a circular base 26 cm in interior height while supported by an octagonal drum with 70 cm exterior height.



Figure A.7. Tire Tahtakale Hamamı, interior and exterior views of *sıcaklık* main space dome.

**Construction technique:** *Sıcaklık* main space dome was constructed with brick and lime mortar as binder. The dome was covered with horasan plaster 1-1.5 cm in thickness interior while 4-5 cm on the exterior. The bricks used in the bond are in the dimensions of 39-40 x 27-28 x 4-4.5 cm, 30-31 x 23-24 x 4-4.5 cm as whole bricks and 23-24 x 14-15 x 4-4.5 cm as half bricks. The flush joints, both vertical and horizontal, have dimensions between 1.5 and 2.5 cm in interior width, while between 3 and 5 cm on the exterior.

**Bond type:** Horizontal stacking of the short side faces in places non-parallel rows.

**Lighting elements: Oculi on the curved surfaces**

**Construction technique:** Oculi, as the lighting order in *aralık* and *ılıkık* dome, were formed with brick bond in which the bricks were stacked long surfaces forming hexagonal openings in the dome thickness. The surfaces of the oculi were formed with lime mortar coating that included small brick pieces and plastered with horasan.

**Volume:** Depressed pointed

**Profile:** Depressed pointed arc

**Center number:** 2

**Distance between two centers:** 35 cm

**Center height:** 1.57 m

**Dome span:** 3.40 m

**Impost height (dome height):** 1.49 m

**Dome thickness:** 0.60-0.65 m

**Impost line:** Raised

**Center - impost relation:** Impost line is 8 cm higher than central line

**Impost – wall relation:** Impost is 21-26 cm from wall plane to the interior side

**Dome height / Dome span, Ratio:** 1.49 m / 3.40 m, 0.43



**Dome thickness / Dome span, Ratio:** 0.65 m / 3.40 m, 0.19

**Height of transition element / Dome span, Ratio:** 0.85 m / 3.40 m, 0.25

**Height of exterior supporting element / Dome span, Ratio:** 0.70 / 3.40, 0.20

#### **The rectangular planned iwans' semi-domes (E01, E02)**

The iwans' domes with 1.72 x 3.56 m interior dimensions cover the rectangular planned spaces located at the northeast and southwest part of the middle unit of *sıcaklık* main space. The segmented profiled semi-domes have interior spans of 1.70 x 3.40 m and a height of 1.60 m. Thickness of the semi-domes at the springing level is 70-75 cm and at the top of the semi-domes 42-45 cm, while thickness at the springing level is 60-65 cm and at the top 35-37 cm in the slices. In the middle, on the top of semi-domes there are 36x36 cm square planned skylight openings and on the curved surfaces of the semi-domes there are hexagonal shape oculi. The equal-size hexagonal shape oculi were arranged in the interior surfaces of the slices in two horizontal rows in which four oculi were placed at the southwest iwan and two oculi at the northeast iwan in the external row while two oculi at the southwest iwan and four oculi at the northeast in the internal row. The oculi are in a form having an opening 24 cm interior while 14 cm exterior size narrowing from interior towards exterior. Interior surfaces were plastered with horasan 0.5 - 1 cm in thickness. Transition to the semi-domes was provided with squinches that were decorated with muqarnas 65 cm in height. The dome was raised above a rectangular base 25 cm in interior height while supported by a rectangular drum with 50 cm exterior height.



Figure A.8. Tire Tahtakale Hamami, interior and exterior views of rectangular planned segmented iwans' semi-domes.

**Construction technique:** Iwans' semi-domes were constructed with brick and lime mortar as binder. The semi-domes were covered with horasan plaster 1-1.5 cm in interior thickness while 4-6 cm on the exterior. The bricks used in the bond are in the dimensions of 39-40 x 27-28 x 4-4.5 cm as whole bricks and 23-24 x 14-15 x 4-4.5 cm as half bricks. The flush joints, both vertical and horizontal, have dimensions between 1.5 and 2.5 cm in interior width, while between 2 and 5 cm on the exterior.

**Bond type:** Horizontal stacking of the short side faces in places non-parallel rows as forming slices in the semi-domes.

**Lighting elements:** Skylight on the top, oculi on the curved surfaces

**Construction technique:** Skylight on the top and oculi were formed with brick bond. The surfaces of the skylight and oculi were formed with lime mortar coating that included small brick pieces and plastered with horasan.

**Volume:** Segmented quarter sphere

**Profile:** Segmented semi-circular arc

**Center number:** 1

**Center height:** 1.68 m

**Semi-dome span:** 1.70x3.40 m

**Impost height (dome height):** 1.60 m

**Dome thickness:** 0.70-0.75 m

**Impost line:** Raised

**Center - impost relation:** Impost line is 8 cm higher than central line

**Impost – wall relation:** Impost is 12 cm from wall plane to the interior side

**Semi-dome height / Semi-dome span (short side), Ratio:** 1.60 m / 1.70 m, 0.94

**Semi-dome height / Semi-dome span (long side), Ratio:** 1.60 m / 3.40 m, 0.47

**Semi-dome thickness / Semi-dome span, Ratio:** 0.75 m / 3.40 m, 0.22

**Height of transition element / Semi-dome span, Ratio:** 0.65 m / 3.40 m, 0.19

**Height of exterior supporting element / Semi-dome span, Ratio:** 0.50 / 3.40, 0.14

### **The square planned iwan at the north side (E03)**

The iwan's dome with 3.46 x 3.82 m interior dimensions covers the square planned space located at the northwest part of the middle unit of *sıcaklık* main space. The octagonal depressed pyramidal profiled dome has interior span of 3.35 m and a dome height of 69 cm. Thickness of the dome at the springing level is 47-55 cm and at the top of the dome 47-50 cm. There is a one hexagonal-shape oculus on each surface of pyramidal dome and placed an octagonal cupola at the top with 40 cm of each side. The oculi are in a form having an opening with 23-24 cm interior while 13-14 cm exterior size narrowing from interior towards exterior. Interior surfaces were plastered with horasan 0.5 - 1 cm in thickness. Transition to the dome was provided with pendentives that were decorated with muqarnas 1.23 m in height. The dome was raised above an octagonal base 10 cm in interior height while supported by a hexagonal drum 1.20 m in exterior height. In addition to the hexagonal drum a second drum 40 cm in height which supports the southwest side of dome was placed over the lower one.



Figure A.9. Tire Tahtakale Hamamı, interior and exterior views of square planned iwan's dome.

**Construction technique:** The square planned depressed octagonal pyramidal iwan's dome was constructed with brick and lime mortar as binder. The dome was covered with horasan plaster 1-1.5 cm in interior thickness while 4-5 cm on the exterior and coated with a thick layer of lime mortar 10-15 cm in thickness including small and large pieces of slate stones, bricks and tiles. The bricks used in the bond are in the dimensions of 30-31 x 23-24 x 4-4.5 cm as whole bricks and 23-24 x 14-15 x 4-4.5 cm as half bricks. The flush joints, both vertical and horizontal, have dimensions between 1.5 and 2.5 cm in interior width, while between 3 and 4 cm on the exterior.

**Bond type:** The bond type is brick. Along the raised surfaces of the depressed octagonal pyramidal dome the bricks were stacked overlapping and side by side in radial order towards the centre of the cross-sections of dome octagonal base edges at the springing zone of the dome. The long surfaces of bricks were placed in the dome thickness while short surfaces of bricks were placed facing inner and outer surfaces.

**Lighting elements: Lighting cupola on the top, oculi on the curved surfaces**

**Construction technique:** Lighting cupola on the top and oculi were formed with brick bond. The lighting cupola on the top was formed with an octagonal frame at the top of dome, which was arranged by stacking long surfaces of the half-bricks side by side in perpendicular order to the horizontal plane in the dome thickness. Between the half-bricks forming the octagonal frame

and whole bricks stacked radial towards the center of the dome forming the dome thickness were filled with lime mortar including brick pieces and dust. The interior surface of octagonal pyramidal dome was decorated with horasan plaster in a star shape motive having octagonal parts and each oculus was placed in each surface. Oculi were formed with brick bond in which the bricks were stacked long surfaces forming hexagonal openings in the dome thickness. The surfaces of the lighting cupola and oculi were formed with lime mortar coating that included small brick pieces and plastered with horasan.

**Volume:** Truncated depressed octagonal pyramid

**Profile:** Inclined plane

**Pyramidal dome span:** 3.35 m

**Pyramidal dome height (distance between dome base plane and dome top):** 0.69 m

**Dome thickness:**  $0.55 + 0.15 = 0.70$  m

**Impost line:** Raised

**Base plane - impost relation:** Impost line is 10 cm higher than base plane

**Impost – wall relation:** Impost is flush with wall plane

**Pyramidal dome height / Octagonal base span, Ratio:** 0.69 m / 3.35 m, 0.20

**Dome thickness / Dome span, Ratio:** 0.70 m / 3.35 m, 0.20

**Height of transition element / Dome span, Ratio:** 1.23 m / 3.35 m, 0.36

**Height of exterior supporting element / Dome span, Ratio:** 1.20 / 3.35, 0.35

#### **The northeast *halvet* dome (H01)**

Dome covers the square planned space that was juxtaposed with *sıcaklık* main space from east side with 3.75 x 3.79 m interior dimensions. The depressed pointed arch profiled dome has interior span of 3.60 m and a dome height of 1.51 m. Thickness of the dome at the springing level is 60-65 cm and at the top of the dome 52-55 cm. The dome has a lighting cupola with a 40 cm opening formed in circular frame at the base and oculi that are in three horizontal rows with equal-size hexagonal shape as binary and single orders on the curved surface of the dome. At this order, the oculi was situated as eight oculi in each row in which oculi were placed as binary in the internal while one in the external two rows. The triple layout was constituted by means of placing the binary oculi in the internal row close to the one oculus in the middle row with alternating order. The oculi is in a form having opening with 23-24 cm interior while 13-14 cm exterior size narrowing from interior towards exterior. Interior surfaces were plastered with horasan 0.5 - 1 cm in thickness. Transition to the dome was provided with Turkish triangles 85 cm in height. The dome was raised above an octagonal base 25 cm in interior height while supported by an octagonal drum with 50 cm exterior height.



Figure A.10. Tire Tahtakale Hamami, interior and exterior views of northeast *halvet* dome.

**Construction technique:** The northeast *halvet* dome was constructed with brick and lime mortar as binder. The dome was covered with horasan plaster 1-1.5 cm in thickness interior while 6-8 cm on the exterior. The bricks used in the bond are in the dimensions of 27-28 x 17-18 x 4-4.5 cm as whole bricks and 23-24 x 14-15 x 4-4.5 cm as half bricks. The flush joints, both vertical and horizontal, have dimensions between 1.5 and 2.5 cm in interior width, while between 3 and 5 cm on the exterior.

**Bond type:** Horizontal stacking of the short side faces in places non-parallel rows.

**Lighting elements: Lighting cupola on the top, oculi on the curved surfaces**

**Construction technique:** Lighting cupola on the top and oculi were formed with brick bond. The lighting cupola was formed with a circular frame at the top of dome, which was arranged by stacking long surfaces of the half-bricks side by side in perpendicular order to the horizontal plane in the dome thickness. Between the half-bricks forming the octagonal frame and whole bricks stacked radial towards the center of the dome forming the dome thickness were filled with lime mortar including brick pieces and dust. Oculi were formed with brick bond in which the bricks were stacked long surfaces forming hexagonal openings in the dome thickness. The surfaces of the lighting cupola and oculi were formed with lime mortar coating that included small brick pieces and plastered with horasan.

**Volume:** Depressed pointed

**Profile:** Depressed pointed arc

**Center number:** 2

**Distance between two centers:** 25 cm

**Center height:** 1.66 m

**Dome span:** 3.60 m

**Impost height (dome height):** 1.51 m

**Dome thickness:** 0.60-0.65 m

**Impost line:** Raised

**Center - impost relation:** Impost line is 15 cm higher than central line

**Impost – wall relation:** Impost is 12-16 cm from wall plane to the interior side

**Dome height / Dome span, Ratio:** 1.51 m / 3.60 m, 0.42

**Dome thickness / Dome span, Ratio:** 0.65 m / 3.60 m, 0.18

**Height of transition element / Dome span, Ratio:** 0.85 m / 3.60 m, 0.23

**Height of exterior supporting element / Dome span, Ratio:** 0.50 / 3.60, 0.13

### **The northwest *halvet* dome (H02)**

The dome covers the square planned space that was juxtaposed with *sıcaklık* main space from west side with 3.71 x 3.72 m interior dimensions. The depressed pointed arch profiled dome has interior span of 3.60 m and a dome height of 1.51 m. Thickness of the dome at the springing level is 60-65 cm and at the top of the dome 52-55 cm. The dome has a lighting cupola with a 40 cm opening formed in circular frame at the base and oculi that are in three horizontal rows with equal-size hexagonal shape in each row as binary and single orders on the curved surface of the dome. At this order, the oculi were situated as senary oculi in each row in which oculi were placed as binary in the internal while one in the external two rows. The triple layout was constituted by means of placing the binary oculi in the internal row close to the one oculus in the middle row within alternating order. The oculi opening were arranged smaller in the interior row than exterior two rows. The oculi is in a form having an opening 30 cm interior while 15-17 cm exterior size in two exterior rows whereas with 23-24 cm interior while 13-14 cm exterior size in the internal row with narrowing from interior towards exterior. Interior surfaces were plastered with horasan 0.5 - 1 cm in thickness. Transition to the dome was provided with Turkish triangles 85 cm in height. The dome was raised above an octagonal base 25 cm in interior height while supported by an octagonal drum with 50 cm exterior height.



Figure A.11. Tire Tahtakale Hamamı, interior and exterior views of northwest *halvet* dome.

**Construction technique:** The northeast *halvet* dome was constructed with brick and lime mortar as binder. The dome was covered with horasan plaster 1-1.5 cm in interior thickness while 6-8 cm on the exterior and coated with a thick layer of lime mortar 12-15 cm in thickness including small and large pieces of slate stones, bricks and tiles. The bricks used in the bond are in the dimensions of 27-28 x 17-18 x 4-4.5 cm as whole bricks and 23-24 x 14-15 x 4-4.5 cm as half bricks. The flush joints, both vertical and horizontal, have dimensions between 1.5 and 2.5 cm in interior width, while between 3 and 5 cm on the exterior.

**Bond type:** Horizontal stacking of the short side faces in places non-parallel rows.

**Lighting elements: Lighting cupola on the top, oculi on the curved surfaces**

**Construction technique:** Lighting cupola on the top and oculi on the curved surface of dome were formed with brick bond as the same with northeast *halvet* dome.

**Volume:** Depressed pointed

**Profile:** Depressed pointed arc

**Center number:** 2

**Distance between two centers:** 26 cm

**Center height:** 1.65 m

**Dome span:** 3.60 m

**Impost height (dome height):** 1.51 m

**Dome thickness:** 0.60-0.65 m

**Impost line:** Raised

**Center - impost relation:** Impost line is 14 cm higher than central line

**Impost – wall relation:** Impost is 12-16 cm from wall plane to the interior side

**Dome height / Dome span, Ratio:** 1.51 m / 3.60 m, 0.42

**Dome thickness / Dome span, Ratio:** 0.65 m / 3.60 m, 0.18

**Height of transition element / Dome span, Ratio:** 0.85 m / 3.60 m, 0.23

**Height of exterior supporting element / Dome span, Ratio:** 0.50 / 3.60, 0.13



## Catalogue No: 2- Construction Name: Tire Hekim Hamamı

### 1. Construction Date

The *hamam* has no inscription or foundation charter; however, there is information regarding the person who constructed the building and the construction date in some sources. In the information given by A.M.Armağan, it is stated that, the building was constructed by Altuncuzade who was a doctor (called Hekim in Turkish) of Fatih Sultan Mehmet (1432-1481 AD); however, no source is indicated (Armağan 1991, p. 89). The existence of a doctor named Altuncuzade, indicated by M. Süreyya (Süreyya 1996) and living in the same period, supports to think that it is the same doctor indicated by Armağan. Moreover, due to the intensive use of the plan scheme of the baths in the 15<sup>th</sup> century, it can be claimed that the *hamam* was built in the 15<sup>th</sup> century (Çakmak 2002, pp.55-56).



Figure A.12. Tire Hekim Hamamı, the southwest view of superstructure (2008).

### 2. Plan Characteristics

The building is a double *hamam* consisting of two sections as the men's and the women's. The men's section is located in the east part of the bath, while the women's section is located in the west. There are four spaces remaining from the men's section, which are the rectangular planned *trastlık* space and three square planned spaces connected to each other. A square planned space enlarged by barrel vaulted unit from the west and two square planned spaces articulated from west and south directions are the spaces remaining from the women's section.

Both the men's and the women's spaces are covered by domes. In the west part of the *hamam*, there is a rectangular planned water reservoir, which was in common use for both sections and aligned in north-south direction. Both the men's and the women's sections can be evaluated within the plan type of the identical spaces of *ılıklık*, *sıcaklık* and *halvet* (Eyice 1960).

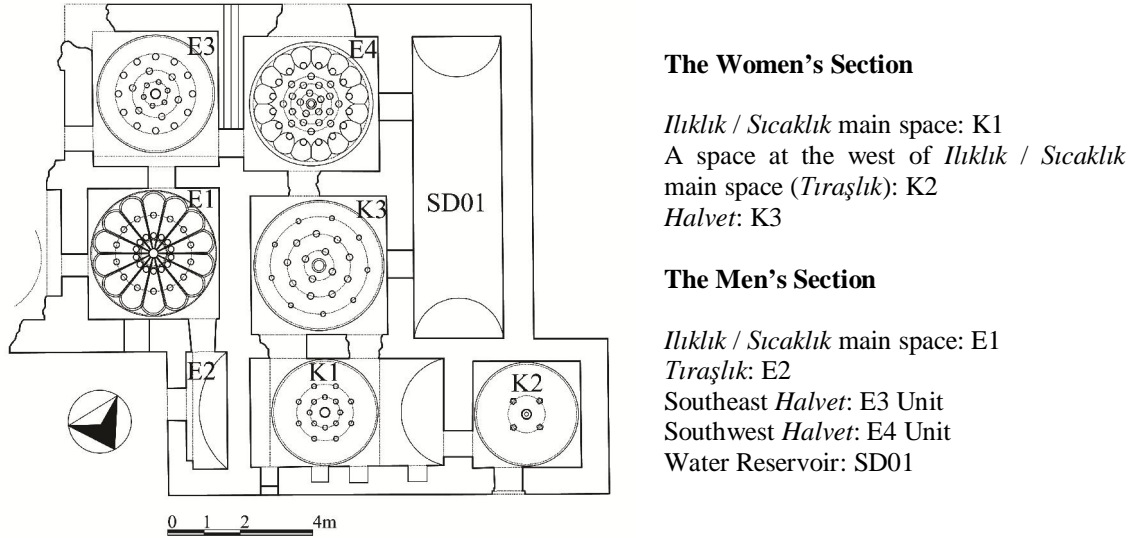

Figure A.13. Tire Hekim Hamamı, superstructure plan (2008, revised the plan scheme from C. Çakmak)

### 3. Definition of Domes

#### The Women's Section

##### *Ilıklık / Sıcaklık* main space dome (D1)

*Ilıklık / sıcaklık* main space dome covers the square planned middle unit of rectangular planned space with the interior dimensions of 2.87 x 5.39 m. The dome was supported by an arch at the east while by barrel vault at the west. The depressed circle profiled dome has an interior span of 2.76 m and a height of 1.10 m. Thickness of the dome at the springing level is 55-60 cm and at the top of the dome 42-45 cm. The dome has a lighting cupola with a circular shaped base and a span of 40 cm at the top of dome and oculi on the curved surfaces in two horizontal rows with eight circular shape oculi each, the upper circular row of which is relatively smaller sized than lower one. Interior surfaces were plastered with horasan 0.5 - 1 cm in thickness. Transition to the dome was provided with pendentives 1.85 cm in height. The dome was raised above a circular base 25 cm in interior height while supported by a circular exterior drum of 45-75 cm in height.



Figure A.14. Tire Hekim Hamamı, interior and exterior views of *ılıklık / sıcaklık* main space dome of the women's section.

**Construction technique:** *Ilıklık / Sıcaklık* main space dome was constructed with brick and lime mortar as binder. The dome was covered with horasan plaster 1-1.5 cm in interior thickness while 8-13 cm on the exterior and coated with a thick layer of lime mortar 10-15 cm in thickness including small and large pieces of slate stones, bricks and tiles with covering thick layer with traditional tiles overlapped. The bricks used in the bond are in the dimensions of 27-28 x 17-18 x 4-5 cm as whole bricks and 23-24 x 14-15 x 4-4.5 cm and 26-27 x 13-14 x 4-5 cm as half bricks. The flush joints, both vertical and horizontal, have dimensions between 1.5 and 2.5 cm in interior width, while between 2 and 5 cm on the exterior.

**Bond type:** Horizontal and adjacent stacking of the short side faces in parallel rows

**Lighting elements: Lighting cupola on the top, oculi on the curved surfaces**

**Construction technique:** Lighting cupola on the top was formed with a circular frame at the top of dome with 40 cm span, which was arranged by stacking long surfaces of the half-bricks side by side occurred in perpendicular order to the horizontal plane in the dome thickness. Between the half-bricks forming the circular frame and whole bricks stacked radial towards the center of the dome forming the dome thickness were filled with lime mortar including brick pieces and dust. Upper side of the cupola was formed with a hemispherical-shaped terracotta lid 1.5 cm in thickness and brick bond arranged by half-bricks 15 cm in thickness overlapped over the terracotta material. The surface was covered with horasan plaster 1-1.5 cm in interior thickness while 5-8 cm on the exterior and coated with a thick layer of lime mortar 8-10 cm in thickness including small and large pieces of slate stones, bricks and tiles. Oculi were formed with the use of terracotta pipes that are in truncated conical form in brick bond in which the bricks were stacked long surfaces forming openings in order to place terracotta material in the dome thickness. Oculi, narrowed from interior to exterior, have 24-27 cm interior span while 15-16 cm exterior, 32 cm length and 1.5 cm thickness. Between the bricks stacked radial towards the center of the dome forming the dome thickness and the terracotta oculi were filled

with lime mortar including brick pieces and dust. The surfaces of the oculi (terracotta pipes) were plastered with horasan 1-1.5 cm in thickness.

**Volume:** Depressed

**Profile:** Depressed pointed arc

**Center number:** 2

**Distance between two centers:** 20 cm

**Center height:** 1.38 m

**Dome span:** 2.76 m

**Impost height (dome height):** 1.10 m

**Dome thickness:** 0.55-0.60 m

**Impost line:** Raised

**Center - impost relation:** Impost line is 28 cm higher than central line

**Impost – wall relation:** Impost is 10 cm from wall plane to the interior side

**Dome height / Dome span, Ratio:** 1.10 m / 2.76 m, 0.40

**Dome thickness / Dome span, Ratio:** 0.60 m / 2.76 m, 0.21

**Height of transition element / Dome span, Ratio:** 1.85 m / 2.76 m, 0.67

**Height of exterior supporting element / Dome span, Ratio:** 0.75 m / 2.76 m, 0.27

#### **Dome of a square space located at the west of *ılıklik* / *sıcaklık* main space (K2)**

The dome of the space located in the west of *ılıklik*, which is projected at the west surface of the bath, covers the square planned space with 2.81 x 2.94 m interior dimensions. The depressed circular profiled dome has interior span of 2.80 m and a dome height of 0.91 m. Thickness of the dome at the springing level is 62-65 cm and at the top of the dome 47-52 cm. The dome has a lighting cupola with a circular shaped frame, the span of which is 40 cm, and four oculi that are in one horizontal row and equal-sized pentagonal shape on the curved surface of the dome. The oculi are in a form having opening with 27-30 cm interior while 17-18 cm exterior size narrowing from interior towards exterior. Interior surfaces were plastered with horasan 0.5 to 1 cm in thickness. Transition to the dome was provided with plain triangles 93 cm in height. The dome was raised above a circular base 25 cm in interior height while supported by a circular exterior drum of 55-65 cm in height.



Figure A.15. Tire Hekim Hamamı, interior and exterior views of *tırışlık* (the space at the west of *ılıkılık / sıcaklık* main space) dome of the women's section.

**Construction technique:** The dome was constructed with brick and lime mortar as binder. The dome was covered with horasan plaster 1-1.5 cm in interior thickness while 5-8 cm on the exterior and coated with a thick layer of lime mortar 10-15 cm in thickness including small and large pieces of slate stones, bricks and tiles with covering thick layer with traditional tiles overlapped. The bricks used in the bond are in the dimensions of 27-28 x 17-18 x 4-5 cm as whole bricks and 23-24 x 14-15 x 4-4.5 cm and 26-27 x 13-14 x 4-5 cm as half bricks. The flush joints, both vertical and horizontal, have dimensions between 1.5 and 2.5 cm in interior width, while between 2 and 5 cm on the exterior.

**Bond type:** Horizontal and adjacent stacking of the short side faces in parallel rows

**Lighting elements: Lighting cupola on the top, oculi on the curved surfaces**

**Construction technique:** Lighting cupola on the top and oculi were formed with brick bond like the lighting cupola in *ılıkılık* main unit's dome. The lighting cupola was formed with a circular frame at the top of dome with 40 cm span, which was arranged by stacking long surfaces of the half-bricks side by side in perpendicular order to the horizontal plane in the dome thickness. Between the half-bricks placed in perpendicular order to the horizontal plane and whole bricks stacked radial towards the center of the dome forming the dome thickness were filled with lime mortar including brick pieces and dust. Upper side of the cupola was formed with a hemispherical-shape terracotta lid 1.5 cm in thickness and brick bond arranged by half-bricks 15 cm in thickness overlapped over the terracotta material. The surface was covered with horasan plaster 1-1.5 cm in interior thickness while 5-8 cm on the exterior and coated with a thick layer of lime mortar 8-10 cm in thickness including small and large pieces of slate stones, bricks and tiles. Oculi were formed with brick bond in which the bricks were stacked long surfaces forming pentagonal openings in the dome thickness. Oculi, narrowed from interior to exterior, have 24-27 cm interior span while 15-16 cm exterior. The pentagonal forms of oculi were formed with lime mortar including brick pieces and dust. Over the lime

mortar forming, the exterior surfaces of the oculi were plastered with horasan 1-1.5 cm in thickness.

**Volume:** Depressed

**Profile:** Depressed arc

**Center number:** 1

**Center height:** 1.40 m

**Dome span:** 2.80 m

**Impost height (dome height):** 0.91 m

**Dome thickness:** 0.62-0.65 m

**Impost line:** Raised

**Center - impost relation:** Impost line is 49 cm higher than central line

**Impost – wall relation:** Impost is 10 cm from wall plane to the interior side

**Dome height / Dome span, Ratio:** 0.91 m / 2.80 m, 0.32

**Dome thickness / Dome span, Ratio:** 0.65 m / 2.80 m, 0.23

**Height of transition element / Dome span, Ratio:** 0.93 m / 2.80 m, 0.33

**Height of exterior supporting element / Dome span, Ratio:** 0.65 / 2.80, 0.23

### **The *halvet* dome (K3)**

The dome covers the square planned space that was juxtaposed with *ılık / sıcaklık* main space from south direction with 3.79 x 3.86 m interior dimensions. The depressed circular profiled dome has interior span of 3.70 m and a dome height of 1.44 m. Thickness of the dome at the springing level is 50-55 cm and at the top of the dome 42-45 cm. The oculi, which was made of terracotta material, are in a form having opening with 30 cm interior while 18 cm exterior size in two internal rows whereas with 24-27 cm interior while 15-17 cm exterior size in the external row. The oculi are 38 cm in length, 1.5 in thickness narrowing from interior towards exterior. Interior surfaces of oculi were plastered with horasan 1-1.5 cm in thickness. Transition to the dome was provided with segmented two plain triangles at the corners 1.21 m in height. The dome was raised above a circular base 25 cm in interior height while supported by a circular exterior drum of 80-95 cm in height.



Figure A.16. Tire Hekim Hamami, interior and exterior views of *halvet* dome of the women's section.

**Construction technique:** The dome was constructed with brick and lime mortar as binder. The dome was covered with horasan plaster 1-1.5 cm in interior thickness while 4-5 cm on the exterior and coated with a thick layer of lime mortar 10-15 cm in thickness including small and large pieces of slate stones, bricks and tiles with covering thick layer with traditional tiles overlapped. The bricks used in the bond are in the dimensions of 27-28 x 17-18 x 4-5 cm and 30-31 x 23-24 x 4-5 cm as whole bricks and 23-24 x 14-15 x 4-4.5 cm and 38 x 16 x 4-5 cm as half bricks. The flush joints, both vertical and horizontal, have dimensions between 1.5 and 2.5 cm in interior width, while between 2 and 4 cm on the exterior at the springing level, between 3 and 5 cm at the top of the dome.

**Bond type:** Horizontal and adjacent stacking of the short side faces in parallel rows

**Lighting elements: Lighting cupola on the top, oculi on the curved surfaces**

**Construction technique:** Lighting cupola on the top was formed with brick bond while circular shaped oculi with terracotta material. The lighting cupola was formed with a circular frame at the top of the dome with 60 cm span, which was arranged by stacking long surfaces of the half-bricks side by side in perpendicular order to the horizontal plane in the dome thickness. Between the half-bricks placed in perpendicular order to the horizontal plane and whole bricks stacked radial towards the center of the dome forming the dome thickness were filled with lime mortar including brick pieces and dust. Upper side of the cupola was formed with a hemispherical-shape terracotta lid 1.5 cm in thickness and brick bond arranged by half-bricks 15 cm in thickness overlapped over the terracotta material. The surface was covered with horasan plaster 1-1.5 cm in interior thickness while 5-8 cm on the exterior and coated with a thick layer of lime mortar 8-10 cm in thickness including small and large pieces of slate stones, bricks and tiles. Oculi, made of terracotta material and narrowed from interior to exterior in a truncated conical form, have 24-30 cm interior span while 15-18 cm exterior, 38 cm length and 1.5 cm thickness. Between the bricks stacked radial towards the center of the dome forming the

dome thickness and terracotta oculi were filled with lime mortar including brick pieces and dust. The surfaces of the terracotta pipes were plastered with horasan 1-1.5 cm in thickness.

**Volume:** Depressed

**Profile:** Depressed arc

**Center number:** 2

**Distance between two centers:** 20 cm

**Center height:** 1.85 m

**Dome span:** 3.70 m

**Impost height (dome height):** 1.44 m

**Dome thickness:** 0.55 m

**Impost line:** Raised

**Center - impost relation:** Impost line is 41 cm higher than central line

**Impost – wall relation:** Impost is 10 cm from wall plane to the interior side

**Dome height / Dome span, Ratio:** 1.44 m / 3.70 m, 0.39

**Dome thickness / Dome span, Ratio:** 0.55 m / 3.70 m, 0.14

**Height of transition element / Dome span, Ratio:** 1.21 m / 3.70 m, 0.32

**Height of exterior supporting element / Dome span, Ratio:** 0.95 / 3.70, 0.25

## **The Men's Section**

### ***Ilıklık / Sıcaklık* main space dome (E1)**

*Ilıklık / sıcaklık* main space dome covers the square planned space with 3.49 x 3.58 m interior dimensions. The depressed pointed and segmented profiled dome has interior span of 3.40 m and a dome height of 1.49 m. Thickness of the dome at the springing level is 50-55 cm and at the top of the dome 42-45 cm, while thickness at the springing level is 32-33 cm and at the top of the dome 28-30 cm in the slices. On the top of the dome there is 45 cm circular planned lighting cupola and on the curved surfaces of the dome there are circular shape oculi in two circular rows. Each row consists of fourteen oculi in which each oculus were placed fourteen slices total as single order. The oculi opening were arranged smaller in the internal row than external two rows. The oculi are in a form having opening of 30 cm interior while 15-17 cm exterior size in the external two rows whereas with 23-24 cm interior while 13-14 cm exterior size in the internal row and the oculi are 34 cm in length, 1.5 cm in thickness narrowing from interior towards exterior. Interior surfaces were plastered with horasan 0.5 - 1 cm in thickness. Transition to the dome was provided with segmented squinches at the corners 1.63 cm in height. The segments of squinches are in slight depth at the upper side of transition elements and there were placed small squinches at the lower side. The dome was raised above a



circular base 25 cm in interior height while supported by a circular exterior drum of 75-110 cm in height.



Figure A.17. Tire Hekim Hamamı, interior and exterior views of *ılıklık / sıcaklık* main space dome of the men's section.

**Construction technique:** The dome was constructed with brick and lime mortar as binder. The dome was covered with horasan plaster 1-1.5 cm in interior thickness while 4-5 cm on the exterior and coated with a thick layer of lime mortar 10-15 cm in thickness including small and large pieces of slate stones, bricks and tiles with covering thick layer with traditional tiles overlapped. The bricks used in the bond are in the dimensions of 27-28 x 17-18 x 4-5 cm and 30-31 x 23-24 x 4-5 cm as whole bricks and 23-24 x 14-15 x 4-4.5 cm and 27 x 16 x 4-5 cm as half bricks. The flush joints, both vertical and horizontal, have dimensions between 1.5 and 2.5 cm in interior width, while between 1.5 and 2.5 cm on the exterior horizontal joints and between 3 and 5 cm in width on the exterior vertical joints.

**Bond type:** Horizontal and adjacent stacking of the short side faces in parallel rows

**Lighting elements: Lighting cupola on the top, oculi on the curved surfaces**

**Construction technique:** Lighting cupola on the top was formed with brick bond while circular shaped oculi with terracotta material placed in the slices. The lighting cupola was formed with a circular frame at the top of dome with 45 cm span, which was arranged by stacking long surfaces of the half-bricks side by side in perpendicular order to the horizontal plane in the dome thickness. Between the half-bricks placed in perpendicular order to the horizontal plane and whole bricks stacked radial towards the center of the dome forming the dome thickness were filled with lime mortar including brick pieces and dust. Upper side of the cupola was formed with a hemispherical-shape terracotta lid 1.5 cm in thickness and brick bond arranged by half-bricks 15 cm in thickness overlapped over the terracotta material. The surface was covered with horasan plaster 1-1.5 cm in interior thickness while 5-8 cm on the exterior and coated with a thick layer of lime mortar 8-10 cm in thickness including small and large pieces of

slate stones, bricks and tiles. Oculi were made of terracotta material and narrowed from interior towards exterior in a truncated conical form. Between the bricks stacked radial towards the center of the dome forming the dome thickness and terracotta oculi were filled with lime mortar including brick pieces and dust. The surfaces of the terracotta pipes were plastered with horasan 1-1.5 cm in thickness.

**Volume:** Segmented depressed

**Profile:** Depressed arc

**Center number:** 1

**Center height:** 1.70 m

**Dome span:** 3.40 m

**Impost height (dome height):** 1.49 m

**Dome thickness:** 0.55 m

**Impost line:** Raised

**Center - impost relation:** Impost line is 21 cm higher than central line

**Impost – wall relation:** Impost is 10 cm from wall plane to the interior side

**Dome height / Dome span, Ratio:** 1.49 m / 3.40 m, 0.43

**Dome thickness / Dome span, Ratio:** 0.55 m / 3.40 m, 0.16

**Height of transition element / Dome span, Ratio:** 1.63 m / 3.40 m, 0.48

**Height of exterior supporting element / Dome span, Ratio:** 1.10 / 3.40, 0.32

#### **Dome of a square space located at the southeast of *ılıklik / sıcaklık* main space (E2)**

The dome of the space located at the southeast of *ılıklik / sıcaklık* main space covers the nearly square planned space with 3.14 x 3.75 m interior dimensions. The depressed circular profiled dome has interior span of 3.05 m and a dome height of 1.51 m. Thickness of the dome at the springing level is 50-55 cm and at the top of the dome 42-45 cm. The dome has a lighting cupola with a circular shaped frame, the span of which is 40 cm, and oculi that are in three horizontal rows with twelve oculi in the external row while six oculi in the internal two rows on the curved surface of the dome. The oculi opening were arranged smaller in the internal row than the external two rows. The oculi, which was made of terracotta material, are in a form having an opening of 30 cm interior while 17-18 cm exterior size in the external two rows whereas with 23-24 cm interior and 13-14 cm exterior size in the internal row. The oculi are 38 cm in length, 1.5 cm in thickness narrowing from interior towards exterior. Interior surfaces were plastered with horasan 0.5 - 1 cm in thickness. Transition to the dome was provided with segmented two plain triangles at the corners 1.28 cm in height. The dome was raised above a circular base 25 cm in interior height while supported by a circular drum of 85-110 cm in exterior height.



Figure A.18. Tire Hekim Hamami, interior and exterior views of southeast *halvet* dome of the men's section.

**Construction technique:** The dome, supported by an arch at the north, was constructed with brick and lime mortar as binder. The dome was covered with horasan plaster 1-1.5 cm in interior thickness while 4-5 cm on the exterior and coated with a thick layer of lime mortar 10-15 cm in thickness including small and large pieces of slate stones, bricks and tiles covering thick layer with traditional tiles overlapped. The bricks used in the bond are in the dimensions of 27-28 x 17-18 x 4-5 cm as whole bricks and 23-24 x 14-15 x 4-4.5 cm as half bricks. The flush joints, both vertical and horizontal, have dimensions between 1.5 and 2.5 cm in interior width, while between 3 and 4 cm in exterior width.

**Bond type:** Horizontal and adjacent stacking of the short side faces in parallel rows

**Lighting elements: Lighting cupola on the top, oculi on the curved surfaces**

**Construction technique:** Lighting cupola on the top was formed with brick bond while circular shaped oculi with terracotta material placed in the slices. The lighting cupola was formed with a circular frame at the top of dome with 40 cm span, which was arranged by stacking long surfaces of the half-bricks side by side in perpendicular order to the horizontal plane in the dome thickness. Between the half-bricks placed in perpendicular order to the horizontal plane and whole bricks stacked radial towards the center of the dome forming the dome thickness were filled with lime mortar including brick pieces and dust. Upper side of the cupola was formed with a hemispherical-shape terracotta lid 1.5 cm in thickness and brick bond arranged by half-bricks 15 cm in thickness overlapped over the terracotta material. The surface was covered with horasan plaster 1-1.5 cm in interior thickness while 5-8 cm on the exterior and coated with a thick layer of lime mortar 8-10 cm in thickness including small and large pieces of slate stones, bricks and tiles. Oculi were made of terracotta material and narrowed from interior towards exterior in a truncated conical form. Between the bricks stacked radial towards the center of the dome forming the dome thickness and the terracotta oculi were filled with lime

mortar including brick pieces and dust. The surfaces of the terracotta pipes were plastered with horasan 1-1.5 cm in thickness.

**Volume:** Depressed

**Profile:** Depressed arc

**Center number:** 1

**Center height:** 1.53 m

**Dome span:** 3.05 m

**Impost height (dome height):** 1.51 m

**Dome thickness:** 0.55 m

**Impost line:** Raised

**Center - impost relation:** Impost line is 2-5 cm higher than central line

**Impost – wall relation:** Impost is 10 cm from wall plane to the interior side

**Dome height / Dome span, Ratio:** 1.51 m / 3.05 m, 0.49

**Dome thickness / Dome span, Ratio:** 0.55 m / 3.05 m, 0.18

**Height of transition element / Dome span, Ratio:** 1.28 m / 3.05 m, 0.42

**Height of exterior supporting element / Dome span, Ratio:** 1.10 / 3.05, 0.36

#### **Dome of southwest square planned halvet (E3)**

The dome of southwest halvet, which is segmented at the springing level while plain at the upper parts, covers the square planned space with 3.76 x 3.86 m interior dimensions. The depressed circular profiled dome has interior span of 3.70 m and a dome height of 1.44 m. Thickness of the dome at the springing level is 70-75 cm, in the slices 32-33 cm and at the top of the dome 42-45 cm. The dome has a lighting cupola with a circular shaped frame, the span of which is 45 cm, and oculi that are in four horizontal rows with sixteen circular shaped oculi in each on the curved surface of the dome. In the exterior row, one oculus was placed in each slice within sixteen total slices. The oculi opening were arranged smaller in the internal row than external three rows. The oculi, which were made of terracotta material, are in a form having opening of 30 cm interior while 15-17 cm exterior size in the three external rows whereas with 23-24 cm interior while 13-14 cm exterior size in the internal row. The oculi are 24 cm in length, 1.5 cm in thickness narrowing from interior towards exterior. Interior surfaces were plastered with horasan 0.5 - 1 cm in thickness. Transition to the dome was provided with Turkish triangles 1.25 cm in height. The dome was raised above a circular base 25 cm in interior height while supported by a circular drum of 100-140 cm in exterior height.



Figure A.19. Tire Hekim Hamami, interior and exterior views of southwest *halvet* dome of the men's section.

**Construction technique:** The segmented dome was constructed with brick and lime mortar as binder. The dome was covered with horasan plaster 1-1.5 cm in interior thickness while 4-5 cm on the exterior and coated with a thick layer of lime mortar 10-15 cm in thickness including small and large pieces of slate stones, bricks and tiles covering thick layer with traditional tiles overlapped. The dome has the slices formed by brick bond in a form of an egg just located at the springing level of dome and one oculus was placed in each slice. However, the upper parts of the dome has plain surface. The bricks used in the bond are in the dimensions of 27-28 x 17-18 x 4-5 cm as whole bricks and 23-24 x 14-15 x 4-4.5 cm as half bricks. The flush joints, both vertical and horizontal, have dimensions between 1.5 and 2.5 cm in interior width, while between 2 and 4 cm in width on the exterior horizontal joints and between 3 and 5 cm in width on the exterior vertical joints.

**Bond type:** Horizontal and adjacent stacking of the short side faces in parallel rows

**Lighting elements: Lighting cupola on the top, oculi on the curved surfaces**

**Construction technique:** Lighting cupola on the top was formed with brick bond while circular shaped oculi with terracotta material were placed in the slices. The lighting cupola was formed with a circular frame at the top of dome with 45 cm span, which was arranged by stacking long surfaces of the half-bricks side by side in perpendicular order to the horizontal plane in the dome thickness. Between the half-bricks placed in perpendicular order to the horizontal plane and whole bricks stacked radial towards the center of the dome forming the dome thickness were filled with lime mortar including brick pieces and dust. Upper side of the cupola was formed with a hemispherical-shape terracotta lid 1.5 cm in thickness and brick bond arranged by half-bricks 15 cm in thickness overlapped over the terracotta material. The surface was covered with horasan plaster 1-1.5 cm in interior thickness while 5-8 cm on the exterior and coated with a thick layer of lime mortar 8-10 cm in thickness including small and large pieces of slate stones, bricks and tiles. Oculi were made of terracotta material and narrowed from interior

towards exterior in a truncated conical form. Between the bricks stacked radial towards the center of the dome forming the dome thickness and the terracotta oculi were filled with lime mortar including brick pieces and dust. The surfaces of the terracotta pipes were plastered with horasan 1-1.5 cm in thickness.

**Volume:** Segmented at the springing level, depressed at the upper part

**Profile:** Depressed arc

**Center number:** 2

**Distance between two centers:** 20 cm

**Center height:** 1.85 m

**Dome span:** 3.70 m

**Impost height (dome height):** 1.44 m

**Dome thickness:** 0.75 m

**Impost line:** Raised

**Center - impost relation:** Impost line is 41 cm higher than central line

**Impost – wall relation:** Impost is 10 cm from wall plane to the interior side

**Dome height / Dome span, Ratio:** 1.44 m / 3.70 m, 0.39

**Dome thickness / Dome span, Ratio:** 0.75 m / 3.70 m, 0.20

**Height of transition element / Dome span, Ratio:** 1.25 m / 3.70 m, 0.33

**Height of exterior supporting element / Dome span, Ratio:** 1.40 / 3.70, 0.37

## Catalogue No: 3 – Construction Name: Tire Şeyh Hamamı

### 1. Construction Date

The *hamam* has no inscription. In the book “Tire Hamamları” (2002), the *hamam* was dated back to the 16<sup>th</sup> century according to the sources given by C. Çakmak; one of which is İzmir Regional Directorate of Foundations archive record, number 16, in which it was stated that the construction was built by Şeyh Nusrettin in 1584, and the other one is the book of İ. Aslanoğlu (1978) who stated that the construction was built by Şeyh Nusrettin Efendi at the last quarter of 16<sup>th</sup> century. It can be dated to the 16<sup>th</sup> century based on the sources given by C. Çakmak and according to the use of squinches as transition element in *soyunmalık* space (Önge 1995; Çakmak 2002).



Figure A.20. Tire Şeyh Hamamı, general view of superstructure (2008).

### 2. Plan Characteristics

*Hamam* is composed of, in a plan organization from north to south, square planned *soyunmalık*, rectangular planned and barrel vaulted *ılıklik* / *sıcaklık* main space, and two *halvets* interconnected from one to the other. In addition, in the south part there is a rectangular planned water reservoir juxtaposed to both *halvets*. Two *halvets* were covered with dome while the rectangular planned *ılıklik* and water reservoir were covered with barrel vault. The superstructure of *soyunmalık* is collapsed today. Yet, it can be claimed that *soyunmalık* was also covered with a dome on account of the use of squinches as transition elements in the space.

*Hamam* can be evaluated in the plan type of the identical spaces of *ılıklik*, *sıcaklık* and *halvet* (Eyice 1960), but here *ılıklik* / *sıcaklık* main space is rectangular planned and covered with barrel vault.

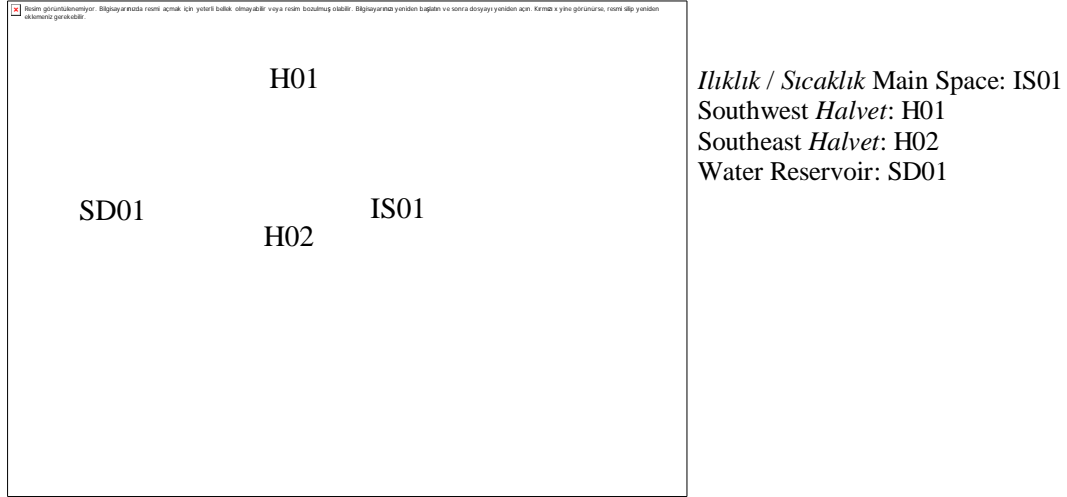

Figure A.21. Tire Şeyh Hamamı, Superstructure plan (2008)

### 3. Definition of Domes

#### Soyunmalık Dome (IS01)

*Soyunmalık* dome covers the square planned space with 5.97 x 6.30 m interior dimensions. Yet, architectural characteristics and construction techniques of dome could not be determined on account of all the walls being nearly collapsed and completely collapsed dome today.

#### Southwest *halvet* dome (H01)

Dome of the space located at the southwest of *ılıklik* / *sıcaklık* main space covers the square planned space with 3.05 x 3.12 m interior dimensions. The slightly depressed profiled dome has interior span of 3.00 m and a dome height of 1.18 m. Thickness of the dome is at the springing level of the dome 40-45 cm and at the top of the dome 35-40 cm. The dome has a lighting cupola with a circular shaped frame, the span of which is 55 cm, and star shaped oculi that are in two horizontal rows with eight oculi in the exterior row while four oculi in the interior row on the curved surface of the dome. The oculi are in a form having opening with 23-24 cm interior while 18-19 cm exterior size in both rows with narrowing from interior towards exterior. Interior surfaces were plastered with horasan 1 - 1.5 cm in thickness. Transition to the



dome was provided with pendentives 1.60 cm in height. The dome was raised above a circular base 25 cm in height interior while settled on the walls directly in the exterior.



Figure A.22. Tire Şeyh Hamamı, interior and exterior views of southwest *halvet* dome.

**Construction technique:** Southwest *halvet* dome was constructed with brick and lime mortar as binder. The dome was covered with horasan plaster 1-1.5 cm in thickness interior while 6-8 cm exterior. The bricks used in the bond are in the dimensions of 30-31 x 20-21 x 3-3.5 cm as whole bricks and in the dimensions of 20-21 x 15-16 x 3-3.5 cm as half bricks. The flush joints, both vertical and horizontal, have dimensions between 1.5 and 2.5 cm in interior width, while between 3 and 4 cm on the exterior.

**Bond type:** Horizontal stacking of the short side faces in places non-parallel rows.

**Lighting elements: Lighting cupola on the top, oculi on the curved surfaces**

**Construction technique:** Lighting cupola on the top and oculi were formed with brick bond. Lighting cupola on the top was formed with a circular frame at the top of dome, which was arranged by stacking long surfaces of the half-bricks side by side in the perpendicular order to the horizontal plane in the dome thickness. Between the half-bricks placed in perpendicular order to the horizontal plane and formed the octagonal frame and the whole bricks stacked radial towards the center of the dome forming the dome thickness were filled with lime mortar including brick pieces and dust. Oculi were formed with brick bond in which the bricks were stacked long surfaces forming star shaped openings in the dome thickness. The surfaces of the lighting cupola and oculi were formed with lime mortar coating including small brick pieces and plastered with horasan.

**Volume:** Slightly depressed

**Profile:** Slightly depressed arc

**Center number:** 1

**Center height:** 1.50 m

**Dome span:** 3.00 m

**Impost height (dome height):** 1.18 m

**Dome thickness:** 0.40-0.45 m

**Impost line:** Raised

**Center - impost relation:** Impost line is 12 cm higher than central line

**Impost – wall relation:** Impost is 12-16 cm from wall plane to the interior side

**Dome height / Dome span, Ratio:** 1.18 m / 3.00 m, 0.39

**Dome thickness / Dome span, Ratio:** 0.45 m / 3.00 m, 0.15

**Height of transition element / Dome span, Ratio:** 1.60 m / 3.00 m, 0.53

### **Southeast *halvet* dome (H02)**

The dome of the space located at the southeast of *ılıklik / sıcaklik* main space and the entrance of which was provided from southwest *halvet* covers the square planned space with 3.07 x 3.09 m interior dimensions. Dome has interior span of 3.00 m; however, due to the dome collapse today the dome height could not be determined. Thickness of the dome at the springing level is 40-45 cm. Transition to the dome was provided with pendentives 1.55 cm in height. The dome was raised above a circular base 20 cm in interior height while settled on the walls directly at the exterior.



Figure A.23. Tire Şeyh Hamamı, interior and exterior views of southeast *halvet* dome.

**Construction technique:** Southeast *halvet* dome was constructed with brick and lime mortar as binder. The dome was covered with horasan plaster 1-1.5 cm in thickness interior while 3-5 cm exterior. The bricks used in the bond are in the dimensions of 30-31 x 20-21 x 3-3.5 cm as whole bricks and in the dimensions of 20-21 x 15-16 x 3-3.5 cm as half bricks. The flush joints, both vertical and horizontal, have dimensions between 1.5 and 2.5 cm in width interior, while between 3 and 4 cm exterior.

**Bond type:** Horizontal stacking of the short side faces in places non-parallel rows.

**Volume:** Could not be determined

**Dome span:** 3.00 m

**Dome thickness:** 0.40-0.45 m

**Impost – wall relation:** Impost is 5-10 cm from wall plane to the interior side

**Dome thickness / Dome span, Ratio:** 0.45 m / 3.00 m, 0.15

**Height of transition element / Dome span, Ratio:** 1.55 m / 3.00 m, 0.51

**Catalogue No: 4 - Construction Name: Tire Mehmet Ağa Hamamı**

**1. Construction Date**

The *hamam* has no inscription. However, the construction can be dated back to the 16<sup>th</sup> century according to the use of squinches as transition elements, two domes in *sıcaklık* main space, and the arrangement of niches in the walls (Önge 1995; Çakmak 2002).

**2. Plan Characteristics**

The building is a double hamam consisting of two sections as the men's and the women's. The men's section is located in the west part of the bath, while the women's section is located in the east. Both the men's and the women's sections are composed in a plan organization from north towards south *soyunmalık*, rectangular planned *ılıkılık*, *sıcaklık* main space consisting of two domes exceptionally in the women's section, and two *halvets*. In addition, in the south part there is a rectangular planned water reservoir in common use of both the men's and the women's sections juxtaposed to the south *halvet* in the women's section and both *halvets* in the men's section from south direction. *Soyunmalık* spaces of both the men's and the women's sections were covered with a timber roof. The middle unit of *sıcaklık* main space, square planned space articulated from north to *sıcaklık* main space, and *halvets* in the men's section were covered with domes. In addition, a space juxtaposed to *ılıkılık* from east, *sıcaklık* main space as two domes placed exceptionally side to side, a space juxtaposed to *sıcaklık* main space from north, and two *halvets* placed at the west side of *sıcaklık* main space were covered with dome. It can be evaluated within the type of plan that has elongated rectangular *sıcaklık* with domed central unit and two *halvets* (Eyice 1960), but in the women's section *sıcaklık* main space were covered with two domes.

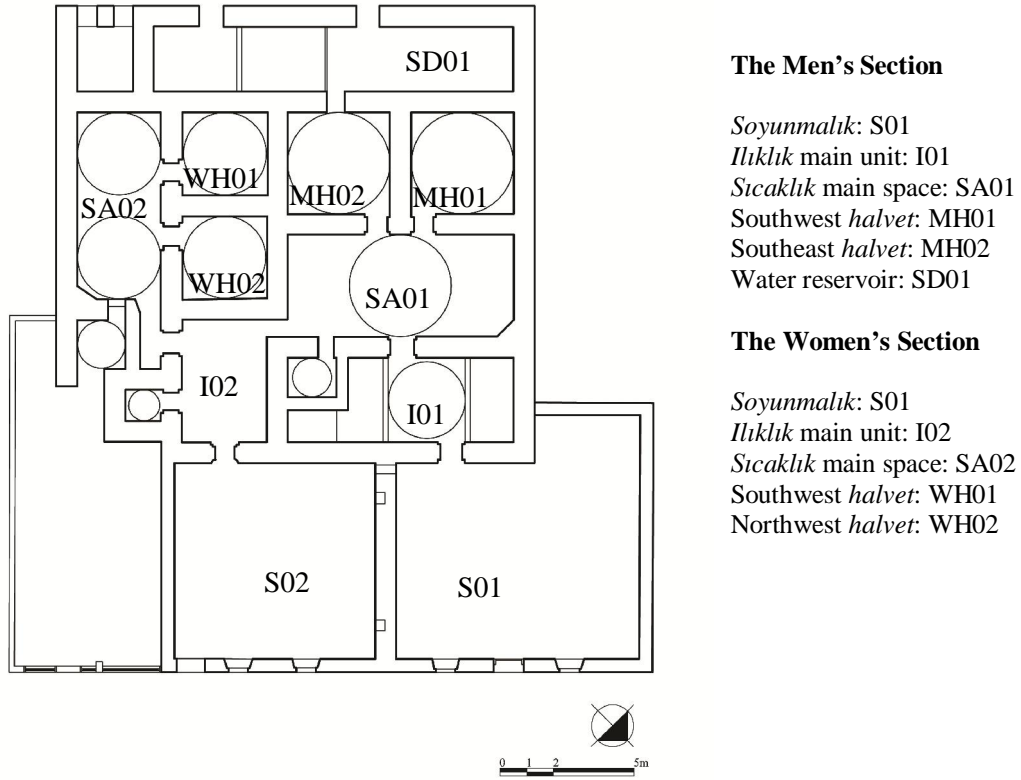

Figure A.24. Tire Mehmet Ağa Hamamı, Plan (2008).

### 3. Definition of Domes

Since all domes in the men's and the women's sections are plastered today, construction techniques of domes could not be determined. However, just the morphological characteristics of domes in both sections were determined.

#### The Men's Section

##### *Sıcaklık* main space, central unit dome (SA01)

The side units of rectangular planned *sıcaklık* main space were covered with barrel vaults while central unit was covered with a dome. The central unit dome covers the square space with 3.88 x 3.97 m interior dimensions. The depressed arch profiled dome has an interior span of 3.85 m and a height of 1.64 m. The dome has a lighting cupola with a 40 cm opening formed in circular frame of the base and oculi that are in three horizontal rows with equal-sized circular shaped and eight oculi in each row on the curved surface of the dome. The oculi are in a form having an opening with 17-18 cm interior while 13-14 cm exterior size with narrowing from interior towards exterior and interior surfaces of which were plastered with horasan. Transition to the dome was provided with pendentives 1.10 m in height. The dome was raised above a circular base 20 cm in interior height while settled directly on the walls on the exterior.



Figure A.25. Tire Mehmet Ağa Hamamı men's section, interior view of *sıcaklık* main space dome.

**Volume:** Depressed

**Profile:** Depressed arc

**Center number:** 1

**Center height:** 1.93 m

**Dome span:** 3.85 m

**Impost height (dome height):** 1.64 m

**Dome thickness:** Not determined

**Impost line:** Raised

**Center - impost relation:** Impost line is 29 cm higher than central line

**Impost – wall relation:** Impost is 5-10 cm from wall plane to the interior side

**Dome height / Dome span, Ratio:** 1.64 m / 3.85 m, 0.42

**Height of transition element / Dome span, Ratio:** 1.10 m / 3.85 m, 0.28

#### **Southwest *halvet* dome (MH01)**

Dome covers the square planned space that was juxtaposed to *sıcaklık* main space from southwest side with 3.82 x 3.84 m interior dimensions. The semi-circular arch profiled dome has interior span of 3.70 m and a dome height of 1.81 m. The dome has lighting cupola, on which hexagonal shaped oculi were placed, with a 40 cm opening formed in circular frame of the base and oculi that are in three horizontal rows with equal-sized hexagonal shaped and eight oculi in each row on the curved surface of the dome. The oculi are in a form having an opening with 17-18 cm interior while 13-14 cm exterior size with narrowing from interior towards exterior and interior surfaces of which were plastered with horasan. Transition to the dome was provided with muqarnas decorated squinches at the corners 0.92 m in height. The dome was

raised above a circular base 20 cm in interior height while settled directly on the walls on the exterior.



Figure A.26. Tire Mehmet Ağa Hamamı men's section, interior view of southwest *halvet* dome.

**Volume:** Semi-circular

**Profile:** Semi circular arc

**Center number:** 1

**Center height:** 1.85 m

**Dome span:** 3.70 m

**Impost height (dome height):** 1.81 m

**Dome thickness:** Not determined

**Impost line:** Raised

**Center - impost relation:** Impost line is 4 cm higher than central line

**Impost – wall relation:** Impost is 4-8 cm from wall plane to the interior side

**Dome height / Dome span, Ratio:** 1.81 m / 3.70 m, 0.49

**Height of transition element / Dome span, Ratio:** 0.92 m / 3.70 m, 0.24

#### **Southeast *halvet* dome (MH02)**

Dome covers the square planned space that was juxtaposed to *sıcaklık* main space from southeast side with 3.82 x 3.85 m interior dimensions. The semi-circular arch profiled dome has interior span of 3.70 m and a dome height of 1.91 m. The dome has lighting cupola, on which hexagonal shaped oculi were placed, with a 60 cm opening formed in circular frame of the base and oculi that are in three horizontal rows with equal-sized hexagonal shaped and nine oculi in each row on the curved surface of the dome. The oculi are in a form having an opening with 17-18 cm interior while 13-14 cm exterior size with narrowing from interior towards exterior and interior surfaces of which were plastered with horasan. Transition to the dome was provided

with muqarnas decorated squinches at the corners 0.95 m in height. The dome was raised above a circular base 20 cm in interior height while settled directly on the walls on the exterior.



Figure A.27. Tire Mehmet Ağa Hamamı men's section, interior view of southeast *halvet* dome.

**Volume:** Semi-circular

**Profile:** Semi circular arc

**Center number:** 1

**Center height:** 1.85 m

**Dome span:** 3.70 m

**Impost height (dome height):** 1.91 m

**Dome thickness:** Not determined

**Impost line:** Lowered

**Center - impost relation:** Impost line is 6 cm lower than central line

**Impost – wall relation:** Impost is 6-10 cm from wall plane to the interior side

**Dome height / Dome span, Ratio:** 1.91 m / 3.70 m, 0.51

**Height of transition element / Dome span, Ratio:** 0.95 m / 3.70 m, 0.25

### The Women's Section

#### *Sıcaklık* main space, central units domes (SA02)

Rectangular planned *sıcaklık* main space was covered with two equal-sized domes. Both domes have the same architectural characteristics. Each dome covers the square planned space with 3.14 x 3.28 m interior dimensions. The depressed arch profiled domes have interior spans of 2.90 – 3.00 m and dome heights of 1.25 – 1.28 m respectively. Both domes have lighting cupola, on which hexagonal shaped oculi were placed, with a 60 cm opening formed in circular frame of the base and oculi that are in three horizontal rows with equal-sized circular shape and six oculi in each row on the curved surface of the domes. The oculi are in a form having an



opening with 17-18 cm interior while 13-14 cm exterior size with narrowing from interior towards exterior and interior surfaces of which were plastered with horasan. Transition to the domes was provided with pendentives 1.09 m in height. The domes were raised above a circular base 25 cm in interior height while settled directly on the walls on the exterior.



Figure A.28. Tire Mehmet Ağa Hamamı women's section, interior view of *sıcaklık* main space dome.

**Volume:** Depressed

**Profile:** Depressed arc

**Center number:** 1

**Center height:** 1.45 – 1.50 m

**Dome span:** 2.90 m

**Impost height (dome height):** 1.25 – 1.28 m

**Dome thickness:** Not determined

**Impost line:** Raised

**Center - impost relation:** Impost line is 20-22 cm higher than central line

**Impost – wall relation:** Impost is 5-10 cm from wall plane to the interior side

**Dome height / Dome span, Ratio:** 1.28 m / 2.90 m, 0.44

**Height of transition element / Dome span, Ratio:** 1.09 m / 2.90 m, 0.37

#### **Southwest *halvet* dome (WH01)**

The dome covers the square planned space that was juxtaposed to *sıcaklık* main space from southwest side with 3.06 x 3.14 m interior dimensions. The depressed arch profiled dome has interior span of 2.90 m and a dome height of 1.22 m. The dome has lighting cupola, on which hexagonal shaped oculi were placed, with a 60 cm opening formed in circular frame of the base and oculi that are in three horizontal rows with equal-sized hexagonal shape and six

oculi in each row on the curved surface of the dome. The oculi are in a form having an opening with 23-24 cm interior while 17-18 cm exterior size with narrowing from interior towards exterior and interior surfaces of which were plastered with horasan. Transition to the dome was provided with pendentives 0.92 m in height. The dome was raised above a circular base 20 cm in interior height while settled directly on the walls on the exterior.



Figure A.29. Tire Mehmet Ağa Hamamı women's section, interior view of southwest *halvet* dome.

**Volume:** Depressed

**Profile:** Depressed arc

**Center number:** 1

**Center height:** 1.45 m

**Dome span:** 2.90 m

**Impost height (dome height):** 1.22 m

**Dome thickness:** Not determined

**Impost line:** Raised

**Center - impost relation:** Impost line is 23 cm higher than central line

**Impost – wall relation:** Impost is 5-8 cm from wall plane to the interior side

**Dome height / Dome span, Ratio:** 1.22 m / 2.90 m, 0.42

**Height of transition element / Dome span, Ratio:** 0.92 m / 2.90 m, 0.31

#### **Northwest *halvet* dome (WH02)**

Dome covers the square planned space that was juxtaposed to *sıcaklık* main space from northwest side with 3.14 x 3.14 m interior dimensions. The depressed arch profiled dome has interior span of 3.00 m and a dome height of 1.12 m. The dome has lighting cupola, on which hexagonal shaped oculi were placed, with a 60 cm opening formed in circular frame of the base

and oculi that are in three horizontal rows with equal-sized hexagonal shape and six oculi in each row on the curved surface of the dome. The oculi are in a form having an opening with 23-24 cm interior while 17-18 cm exterior size with narrowing from interior towards exterior and interior surfaces of which were plastered with horasan. Transition to the dome was provided with pendentives 1.03 m in height. The dome was raised above a circular base 20 cm in interior height while settled directly on the walls on the exterior.



Figure A.29. Tire Mehmet Ağa Hamamı women's section, interior view of northwest *halvet* dome.

**Volume:** Depressed

**Profile:** Depressed arc

**Center number:** 1

**Center height:** 1.50 m

**Dome span:** 3.00 m

**Impost height (dome height):** 1.12 m

**Dome thickness:** Not determined

**Impost line:** Raised

**Center - impost relation:** Impost line is 38 cm higher than central line

**Impost – wall relation:** Impost is 5-8 cm from wall plane to the interior side

**Dome height / Dome span, Ratio:** 1.12 m / 3.00 m, 0.37

**Height of transition element / Dome span, Ratio:** 1.03 m / 3.00 m, 0.34

## Catalogue No: 5 – Construction Name: Tire Karagazi Hamamı

### 1. Construction Date

The *hamam* has no inscription. However, the construction can be dated back to the 15<sup>th</sup> century taking into consideration the arrangement of niches in the walls and the geometrical, floral and muqarnas decorations on the transition zones to the dome (Önge 1995; Çakmak 2002). Furthermore, belonging to Karakadı Necdetin Külliyesi (Complex) stated by C.Çakmak and having the same construction date with the mosque in the Complex built at the end of 14<sup>th</sup> and at the beginning of 15<sup>th</sup> centuries support this construction date (Çakmak 2002).



Figure A.31. Tire Karagazi Hamamı, the general view (2008).

### 2. Plan Characteristics

The building is a double *hamam* consisting of two sections as the men's and the women's. The men's section is located in the east part of the bath, while the women's section is located in the west. The men's section is composed in a plan organization from southwest to northeast of a *soyunmalık* covered with timber roof, square planned *ılıklik*, *sıcaklık* main space, and *halvet* interconnected from one to the other. A square planned *ılıklik* space can only be observed today from the women's section. The spaces of the men's and the women's sections were covered with dome, but the superstructure is lost today. Both the men's and the women's sections can be evaluated within the plan type of the identical spaces of *ılıklik*, *sıcaklık* and *halvet* (Eyice 1960).

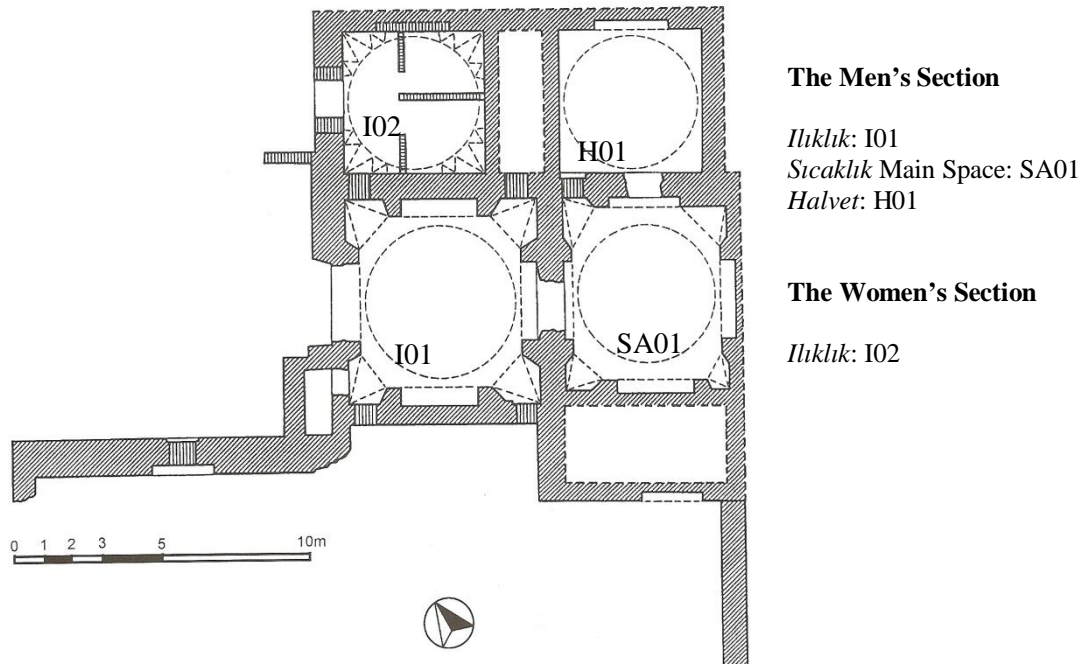

Figure A.32. Tire Karagazi Hamamı, Plan  
 (Source: Çakmak 2002).

### 3. Definition of Domes

#### The Men's Section

##### *Ilıklık* dome (I01)

*Ilıklık* dome covers the square space with 5.70 x 5.77 m interior dimensions. Dome has an interior span of 5.50 m, but height could not be determined since the dome is lost today, as well as, lighting elements. Thickness of the dome is at the springing level of the dome 52-60 cm. Transition to the dome was provided with plain triangles 1.06 m in height. The dome was raised above a circular base 70 cm in interior height while supported by an octagonal drum with 85 cm in exterior height.

**Construction technique:** *Ilıklık* dome was constructed with brick and lime mortar as binder. The dome was covered with horasan plaster 1-1.5 cm in interior thickness while 3-5 cm exterior. The bricks used in the bond are in the dimensions of 34-35 x 20-22 x 4-4.5 cm as whole bricks and in the dimensions of 34-35 x 10-11 x 4-4.5 cm as half bricks. Both vertical and horizontal flush joints have dimensions between 1.5 and 2.5 cm in interior width, while between 3 and 5 cm on the exterior.

**Bond type:** In vertical sequential stacking of long/short faces on interior, horizontal stacking of the long faces on exterior surface.



Figure A.33. Tire Karagazi Hamamı men's section, interior and exterior views of *ılıkık* dome.

**Volume:** Not determined

**Profile:** Not determined

**Center number:** Not determined

**Center height:** 2.75 m

**Dome span:** 5.50 m

**Impost height (dome height):** Not determined

**Dome thickness:** 60 cm

**Impost line:** Not determined

**Center - impost relation:** Not determined

**Impost – wall relation:** Impost is 10-14 cm from wall plane to the interior side

**Dome thickness / Dome span, Ratio:** 0.60 m / 5.50 m, 0.10

**Height of transition element / Dome span, Ratio:** 1.06 m / 5.50 m, 0.19

**Height of exterior supporting element / Dome span, Ratio:** 0.85 / 5.50, 0.15

#### ***Sıcaklık* main space dome (SA01)**

Dome covers the square planned space that was juxtaposed to *ılıkık* from northeast side with 5.63 x 5.67 m interior dimensions. Dome has an interior span of 4.70 m, but height could not be determined since it is lost today, as well as, lighting elements. Thickness of the dome is at the springing level of the dome 62-65 cm. Transition to the dome was provided with plain triangles 1.60 m in height. The dome was raised above a circular base 79 cm in interior height while supported by an octagonal drum 75 cm in exterior height.

**Construction technique:** *Sıcaklık* main space dome was constructed with brick and lime mortar as binder. The dome was covered with horasan plaster 1-1.5 cm in interior thickness while 3-5 cm exterior. The bricks used in the bond are in the dimensions of 34-35 x 20-22 x 4-4.5 cm as whole bricks and in the dimensions of 34-35 x 10-11 x 4-4.5 cm as half bricks. Both vertical and horizontal flush joints have dimensions between 1.5 and 2.5 cm in interior width, while between 3 and 5 cm exterior.

**Bond type:** In vertical sequential stacking of long/short faces on interior, horizontal stacking of the long faces on exterior surface.



Figure A.34. Tire Karagazi Hamamı men's section, interior and exterior views of *sıcaklık* main space dome.

**Volume:** Not determined

**Profile:** Not determined

**Center number:** Not determined

**Center height:** 2.35 m

**Dome span:** 4.70 m

**Impost height (dome height):** Not determined

**Dome thickness:** 65 cm

**Impost line:** Not determined

**Center - impost relation:** Not determined

**Impost – wall relation:** Impost is 40-45 cm from wall plane to the interior side

**Dome thickness / Dome span, Ratio:** 0.65 m / 4.70 m, 0.13

**Height of transition element / Dome span, Ratio:** 1.60 m / 4.70 m, 0.34

**Height of exterior supporting element / Dome span, Ratio:** 0.75 / 4.70, 0.16

#### **Northwest *halvet* dome (H01)**

Dome covers the square planned space that was juxtaposed to *sıcaklık* main space from east side with 4.72 x 4.84 m interior dimensions. Dome has an interior span of 4.55 m, but height

could not be determined since it is lost today, as well as, lighting elements. Thickness of the dome is at the springing level of the dome 52-60 cm. Transition to the dome was provided with pendentives 1.47 m in height. The dome was raised above a circular base 62 cm in interior height while supported by an octagonal drum exterior with 45 cm in height.

**Construction technique:** Northwest *halvet* dome was constructed with brick and lime mortar as binder. The dome was covered with horasan plaster 1-1.5 cm in interior thickness while 3-5 cm exterior. The bricks used in the bond are in the dimensions of 34-35 x 20-22 x 4-4.5 cm as whole bricks and in the dimensions of 34-35 x 10-11 x 4-4.5 cm as half bricks. Both vertical and horizontal flush joints have dimensions between 1.5 and 2.5 cm in interior width, while between 3 and 5 cm on the exterior.

**Bond type:** In vertical sequential stacking of long/short faces on interior, horizontal stacking of the long faces on exterior surface.



Figure A.35. Tire Karagazi Hamamı men's section, interior and exterior views of northwest *halvet* dome.

**Volume:** Not determined

**Profile:** Not determined

**Center number:** Not determined

**Center height:** 2.28 m

**Dome span:** 4.55 m

**Impost height (dome height):** Not determined

**Dome thickness:** 60 cm

**Impost line:** Not determined

**Center - impost relation:** Not determined

**Impost – wall relation:** Impost is 8-15 cm from wall plane to the interior side

**Dome thickness / Dome span, Ratio:** 0.60 m / 4.55 m, 0.13



**Height of transition element / Dome span, Ratio:** 1.47 m / 4.55 m, 0.32

**Height of exterior supporting element / dome span, Ratio:** 0.45 / 4.55, 0.10

### The Women's Section

#### *Ilklik* dome (I02)

Dome covers the square planned space that was juxtaposed to *soyunmalık* from northwest side with 4.70 x 4.80 m interior dimensions. Dome has an interior span of 4.50 m, but height could not be determined since it is lost today, as well as, lighting elements. Thickness of the dome is at the springing level of the dome 60-65 cm. Transition to the dome was provided with Turkish triangles 73 cm in height. The dome was raised above a circular base 80 cm in interior height while supported by an octagonal drum exterior with 80 cm in height.

**Construction technique:** *Ilklik* dome was constructed with brick and lime mortar as binder. The dome was covered with horasan plaster 1-1.5 cm in interior thickness while 6-8 cm exterior. The bricks used in the bond are in the dimensions of 34-35 x 20-22 x 4-4.5 cm as whole bricks and in the dimensions of 34-35 x 10-11 x 4-4.5 cm as half bricks. Both vertical and horizontal flush joints have dimensions between 1.5 and 2.5 cm in interior width, while between 3 and 4 cm on the exterior.

**Bond type:** In vertical sequential stacking of long/short faces on interior, horizontal stacking of the long faces on exterior surface.



Figure A.36. Tire Karagazi Hamami women's section, interior and exterior views of *ilklik* dome.

**Volume:** Not determined

**Profile:** Not determined

**Center number:** Not determined

**Center height:** 2.25 m

**Dome span:** 4.50 m

**Impost height (dome height):** Not determined

**Dome thickness:** 65 cm

**Impost line:** Not determined

**Center-impost relation:** Not determined

**Impost – wall relation:** Impost is 10-15 cm from wall plane to the interior side

**Dome thickness / Dome span, Ratio:** 0.65 m / 4.50 m, 0.14

**Height of transition element / Dome span, Ratio:** 0.73 m / 4.50 m, 0.16

**Height of exterior supporting element / Dome span, Ratio:** 0.80 / 4.50, 0.17

**Catalogue No: 6 – Construction Name: Tire Eski-Yeni Hamamı**

**1. Construction Date**

The *hamam* has no inscription. However, A. M. Armağan states that the construction was belonged to Grand vizier Lütfi Pasha Foundation and was later renovated in 1876 A.D (1293 H.) by Hacı Ömer bin Osman, tenant of the hamam, taking into consideration the foundation record dated 950 H. / 1543 A.D. (Armağan 2003, pp.303-304). In addition, C. Çakmak (2002) states that the construction was built in the 15<sup>th</sup> century by Ibni Melek Foundation taking into consideration the archive record of Lütfi Pasha Foundation in Izmir Region Foundation Directorate, register number 510 and the register page number 215 (Çakmak 2002, p. 70). Thus, it can be dated back to the 16<sup>th</sup> century according to the foundation record dated 1543 stated by A. M. Armağan (Armağan 2003).



Figure A.37. Tire Eski-Yeni Hamamı, the general view of the men's and the women's sections (2008).

**2. Plan Characteristics**

The building is a double *hamam* consisting of two sections as the men's section and the women's section. The men's section is located in the north part of the bath, while the women's section is located in the south. The men's section is composed in a plan organization from east to west a square planned *soyunmalık*, rectangular planned *ılıklik*, cross shaped *sıcaklık* main space consisting of square planned four-iwans and four corner *halvets*. The entrance to *sıcaklık* main space from *ılıklik* was provided through east iwan unit. The entrances to east two corner halvets were provided through east iwan unit. Furthermore, the entrance to west iwan was

provided through the central unit of *sıcaklık* main space, to northwest *halvet* through north iwan, and to southwest *halvet* through south iwan. The women's section, which is planned in the same direction of the men's section, is composed of *soyunmalık*, *ılıklik*, *sıcaklık* main space and two *halvets*. Domed *ılıklik* sub-units were projected to north side in the men's section, while the only domed unit was placed at the north side in the women's section.

In addition, in the west part there is a rectangular planned water reservoir in the common use of both sections. *Soyunmalık*, the sub-units of *ılıklik*, the central unit of *sıcaklık* main space, excluding east iwan the other three iwans and four corner *halvets* were covered with dome in the men's section while *soyunmalık*, *ılıklik* sub-unit, the central unit of *sıcaklık* main space and two corner *halvets* were covered with dome in the women's section. Men's section can be evaluated in the plan type of cross shaped four-iwans and corner *halvets* whereas women's section in the plan type of elongated *sıcaklık* with domed central unit and two *halvets* (Eyice 1960).

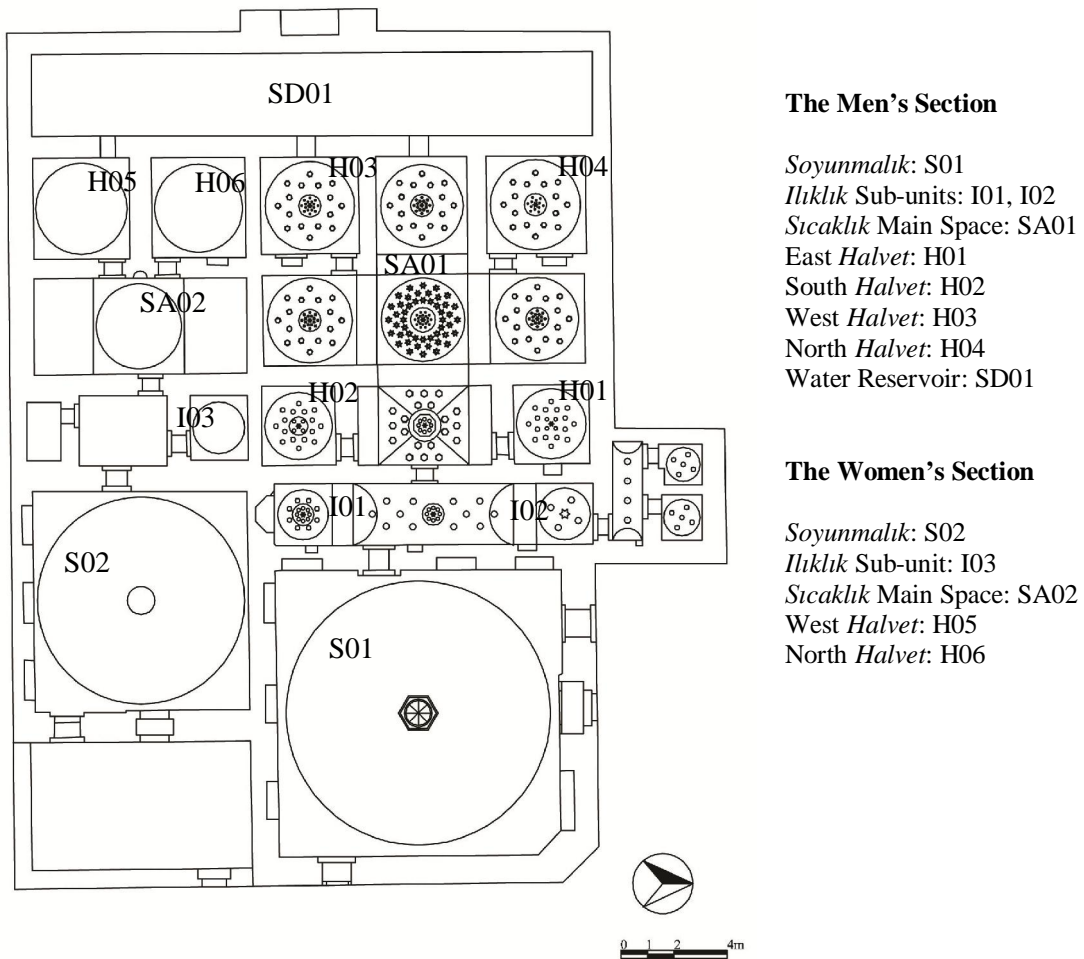

Figure A.38. Tire Eski-Yeni Hamami, Plan (2008).

### **3. Definition of Domes**

Since all the domes in both sections have been renovated today, the original architectural characteristics and construction techniques of domes could not be determined and evaluated.

### **1. Construction Date**

The *hamam* has no inscription. It is stated by İ. Aslanoğlu (1978), without indicating any source, that the *hamam* was part of Complex with Yalınayak Mosque, Madrasah and the storage of *hamam*, as well as, by A. Armağan that the *hamam* was built by Hasan Çavuş, son of Ferhat Pasha a grand vizier (*sadrızam*) of Kanuni Süleyman and Selim II. Furthermore, Aslanoğlu and Armağan claim that the *hamam* was constructed in the 16<sup>th</sup> century (Armağan 1991, p.70; Aslanoğlu 1978, p.71). In General Directorate of Foundation Archive, the construction is registered on the foundation record, number 26 regarding Tire, without indicating any foundation record that the construction was built in seventeenth century (Çakmak 2002, p. 80). The *hamam* can be dated back to the 16<sup>th</sup> century taking into consideration the use of squinches to provide transition to the domes and the advance plan type of *sıcaklık* as four iwans and corner halvets (Çakmak 2002, p. 80).



Figure A.39. Tire Yalınayak Hamamı, a general view of superstructure (2008).

### **2. Plan Characteristics**

The hamam is a double bath consisting of two sections as the men's and the women's. The men's section is located in the east part of the bath, while the women's section is located in the west. The men's section is composed in a plan organization from south to north a rectangular planned *soyunmalık*, the square planned main space of which was extended with a barrel vaulted space to west and with two barrel vaulted spaces to the south, rectangular planned *ılıkık*, and

cross shaped *sıcaklık* main space consisting of an octagonal main unit, four-iwans, and four corner *halvets*. The women's section is composed in a plan organization from south to north a square planned *soyunmalık*, *rectangular planned ılıklik*, *sıcaklık* main space and two *halvets*. In addition, in the north part there is a rectangular planned water reservoir in common use of both sections.

The main unit of *soyunmalık* located at the east part, octagonal planned central unit of *sıcaklık* main space and corner *halvets* were covered with domes while the west and south parts of *soyunmalık*, *rectangular planned ılıklik* and iwans were covered with vaults in the men's section. However, *soyunmalık* was covered with a dome whereas *ılıklik*, *sıcaklık* main space and *halvets* were covered with vaults in the women's section.

The men's section can be evaluated in the plan type of cross shaped four-iwans and corner *halvets* (Eyice 1960), but here each of the iwans has a plan order of double units joined to each other. On the other hand, women's section can be evaluated in the plan type of elongated *sıcaklık* with domed central unit and two *halvets* (Eyice 1960), but here *sıcaklık* main space and *halvets* were covered with vaults.

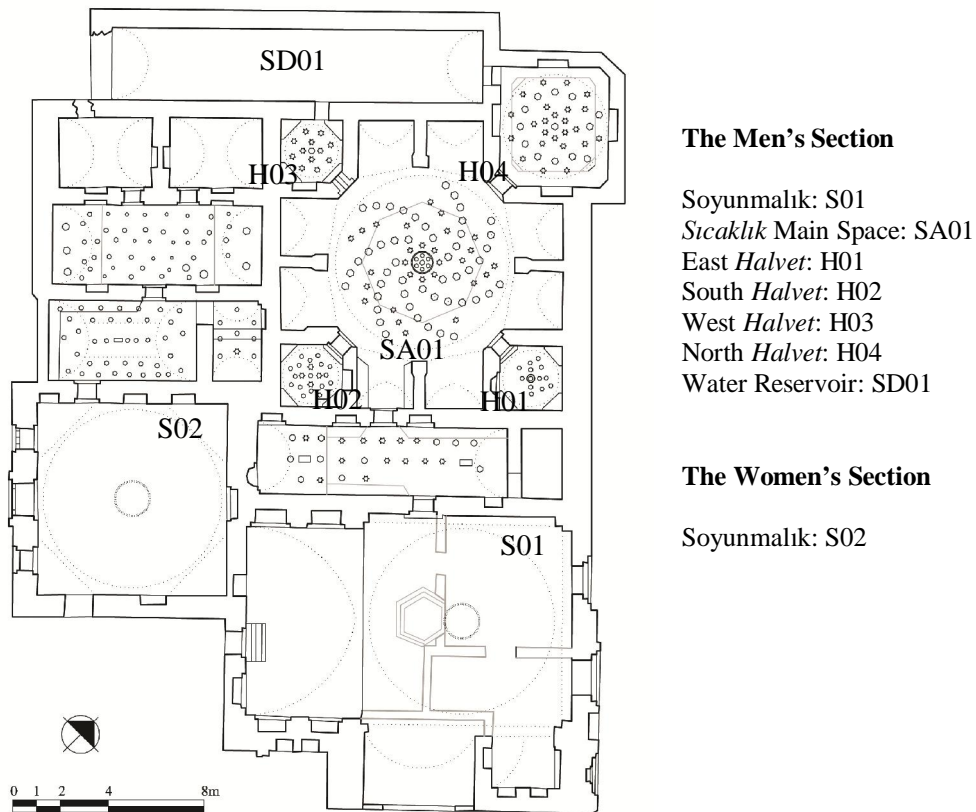

Figure A.40. Tire Yalınayak Hamamı, Plan (2008).

### 3. Definition of Domes

#### The Men's Section

##### *Soyunmalık* Dome (S01)

*Soyunmalık* dome covers the square planned central unit of rectangular planned space with 9.11 x 14.25 m interior dimensions. The dome is supported by an arch and vault in the east, as well as, by barrel vault in the south. The slightly depressed semi-circular profiled dome has an interior span of 8.20 m and a height of 3.57 m. Thickness of the dome at the springing level is 73-75 cm and at the top of the dome 60-66 cm. The dome has a lighting lantern with a circular shaped base and a span of 1.25 m on the top of dome and depressed pointed arched windows with a width of 60 cm at the level of transition zone, placed on the interior walls while on the exterior below drum. Interior surfaces were plastered with horasan 0.5 to 1 cm in thickness. Transition to the dome was provided with pendentives 3.49 m in height. The dome was raised above a circular base 27 cm in interior height while supported by two octagonal exterior drums successively, below with 1.20 m and above with 1.00 m in height.



Figure A.41. Tire Yalınayak Hamamı men's section, interior and exterior views of *soyunmalık* dome.

**Construction technique:** *Soyunmalık* dome was constructed with brick and lime mortar as binder. The dome was covered with horasan plaster 1-1.5 cm in thickness interior while 3-5 cm exterior and coated with a thick layer of lime mortar 5-10 cm in thickness including small and large pieces of slate stones, bricks and tiles covering thick layer with traditional tiles overlapped. The bricks used in the bond are in the dimensions of 30-31 x 23-24 x 4-4.5 cm as whole bricks and 23-24 x 14-15 x 4-4.5 cm as half bricks. In the original bond, both vertical and horizontal flush joints have dimensions between 1.5 and 2.5 cm in interior width.

**Bond type:** Horizontal and adjacent stacking of the short side faces in parallel rows.



**Lighting elements: Lighting lantern on the top, windows at the transition zone**

**Construction technique:** Lighting lantern was formed with a circular frame at the top of dome and with raising the frame by means of brick bond and placing glass surfaces with an octagonal form on the frame. Circular frame was arranged by stacking long surfaces of the bricks in a horizontal line side by side and in perpendicular order to the horizontal plane in the dome thickness. Between the bricks placed in perpendicular order to the horizontal plane forming the circular frame and the bricks stacked in radial order towards the center of the dome forming the dome thickness were filled with lime mortar including large and small brick pieces and dust. The windows, arranged in the transition zone at the same level of pendentives on the interior while at the same level of below drum on the exterior, are the depressed pointed arched openings.

**Volume:** Slightly depressed semi-circular

**Profile:** Slightly depressed semi-circular arc

**Center number:** 2

**Distance between two centers:** 58 cm

**Center height:** 4.10 m

**Dome span:** 8.20 m

**Impost height (dome height):** 3.57 m

**Dome thickness:** 0.73-0.75 m

**Impost line:** Raised

**Center - impost relation:** Impost line is 53 cm higher than central line

**Impost - wall relation:** Impost is 21-25 cm from wall plane to the interior side

**Dome height / Dome span, Ratio:** 3.57 m / 8.20 m, 0.43

**Dome thickness / Dome span, Ratio:** 0.75 m / 8.20 m, 0.09

**Height of transition element / Dome span, Ratio:** 3.49 m / 8.20 m, 0.42

***Sıcaklık* Main Space, Central Unit Dome (SA01)**

*Sıcaklık* main space central unit dome covers the octagonal space with the edge lengths ranging from 4.66-4.76 m. Span between two correspondent edges has dimension of 8.10-8.12 m. The depressed profiled dome has interior span of 7.80 m and a dome height with 2.56 m. Thickness of the dome at the springing level is 60-65 cm and at the top of the dome 45-50 cm. The dome has a lighting cupola with a circular shaped base and a span of 60 cm on the top of dome and oculi in eight circular rows on the curved surfaces. The oculi in the equal-sized hexagonal shape on the dome was located to form a spiral alignment starting from a close level to the springing level towards the top. The last circular row on the top consists of star shaped eight oculi. Among the hexagonal seven oculi aligned in spiral form, star shaped oculi were

placed randomly. The equal-sized oculi in eight circular rows are in a form having interior opening of 23-24 cm while 17 cm in the exterior size with narrowing from interior towards exterior. However, the star shaped oculi placed randomly in-between spiral aligned geometrical order have an interior opening of 18-19 cm while 13-14 cm on the exterior smaller sized than the oculi in spiral alignment and the star shaped oculi in the last row on the top. Transition to the dome was provided with sawtooth shaped elements 85 cm in height. The dome was raised above a circular base 34 cm in interior height while supported by an octagonal exterior drum with 1.00 – 1.10 m in height.



Figure A.42. Tire Yalınayak Hamamı men's section, interior and exterior views of *sıcaklık* main space dome.

**Construction technique:** *Sıcaklık* main space central unit dome was constructed with brick and lime mortar as binder. The dome was covered with horasan plaster 1-1.5 cm in thickness interior while 2-3 cm exterior and coated with a thick layer of horasan mortar 8-10 cm in thickness including small and large pieces of bricks and tiles. The bricks used in the bond are in the dimensions of 30-31 x 25-26 x 3-3.5 cm and 30-31 x 20-21 x 3-3.5 cm as whole bricks and 25-26 x 14-15 x 3-3.5 cm as half bricks. In the bond, both vertical and horizontal flush joints have dimensions between 1.5 and 2.5 cm in interior width while between 2 and 4.5 cm in the exterior.

**Bond type:** Horizontal stacking of long faces on the bottom for a few rows and short faces on top in parallel rows.

**Lighting elements: Lighting cupola on the top, oculi on the curved surfaces**

**Construction technique:** Lighting cupola and oculi were formed with brick bond. Lighting cupola was formed with a circular frame on the top of dome, by stacking long surfaces of the half-bricks side by side in perpendicular order to the horizontal plane in the dome thickness. Between the half-bricks formed the circular frame and the whole bricks stacked radial towards the center of the dome forming the dome thickness were filled with lime mortar including brick pieces and dust. Upper side of cupola was formed with a hemispherical-shaped terracotta lid

1.5 cm in thickness and brick bond arranged with half-bricks 15 cm in thickness overlapped over the terracotta material. The surface was covered with horasan plaster 1-1.5 cm in interior thickness while 4-6 cm on the exterior. Oculi were formed with brick bond in which the bricks were stacked long surfaces forming hexagonal and star shaped openings in the dome thickness. The surfaces of the oculi and lighting cupola were formed with lime mortar coating including small brick pieces in and plastered with horasan.

**Volume:** Depressed

**Profile:** Depressed arc

**Center number:** 2

**Distance between two centers:** 67 cm

**Center height:** 3.90 m

**Dome span:** 7.80 m

**Impost height (dome height):** 2.56 m

**Dome thickness:** 0.60-0.65 m

**Impost line:** Raised

**Center - impost relation:** Impost line is 1.34 m higher than central line

**Impost - wall relation:** Impost is 28-34 cm from wall plane to the interior side

**Dome height / Dome span, Ratio:** 2.56 m / 7.80 m, 0.32

**Dome thickness / Dome span, Ratio:** 0.65 m / 7.80 m, 0.08

**Height of transition element / Dome span, Ratio:** 0.85 m / 7.80 m, 0.10

### **Domes of Square Planned East, West and South Corner Halvets (H01, H02, H03)**

Domes cover the equal-sized square planned spaces that were juxtaposed to the central unit of *sıcaklık* main space from east, west and south sides with interior dimensions of 2.62 x 2.67 m, 2.60 x 2.60 m, and 2.60 x 2.62 m respectively. All the depressed arch profiled domes have interior span with 2.40 m, however, dome heights have dimensions of 76 cm, 58 cm, and 98 cm respectively. Thickness of the domes at the springing level is 45-50 cm and at the top of the dome 35-40 cm.

East and south corner *halvets* have oculi that are in three circular rows equal-sized on the curved surface of the dome. East halvet has lighting cupola with a 35 cm opening formed in circular frame of the base and oculi that are in three horizontal rows equal-sized hexagonal shaped and two oculi in the exterior row, six in the middle row, and four in the interior row on the curved surface of the dome. South *halvet* has a hexagonal framed skylight on the top and equal sized oculi that are in three horizontal rows, eight in the exterior and middle row with hexagonal shape, while four in the interior row with star shape. East *halvet* has a hexagonal framed skylight on the top and equal sized oculi that are in two horizontal rows, eight in the

exterior and four in the interior row with star shape. The oculi are in a form having an opening with 23-24 cm interior while 18 cm exterior size with narrowing from interior towards exterior and interior surfaces of which were plastered with horasan 1-1.5 cm in thickness. Transition to the dome was provided with sawtooth decorated pendentives 0.95 m in height in west *halvet* while with sawtooth decorated squinches at the corners 0.85 m in height in south and east *halvets*. The domes were raised above a circular base 32-35 cm in interior height while settled directly on the walls on the exterior.



Figure A.43. Tire Yalınayak Hamamı men's section, interior and exterior views of the west corner *halvet* dome.

**Construction technique:** The corner *halvet* domes were constructed with brick and lime mortar as binder. The dome was covered with horasan plaster 1-1.5 cm in interior thickness while 6-8 cm in the exterior. The bricks used in the bond are in the dimensions of 30-31 x 20-21 x 3-3.5 cm as whole bricks and 20-21 x 15-16 x 3-3.5 cm as half bricks. In the bond, both vertical and horizontal flush joints have dimensions between 1.5 and 2.5 cm in interior width while between 3 and 5 cm on the exterior.

**Bond type:** Horizontal stacking of the short side faces in places non-parallel rows.

**Lighting elements: Lighting cupola, skylight on the top, oculi on the curved surfaces**

**Construction technique:** Lighting cupola, skylight and oculi were formed with brick bond. Lighting cupola was formed with a circular frame on the top of dome, which was arranged by stacking long surfaces of the half-bricks side by side in perpendicular order to the horizontal plane in the dome thickness. Between the half-bricks forming the circular frame and the whole bricks stacked radial towards the center of the dome forming the dome thickness were filled with lime mortar including brick pieces and dust. As the lighting cupola, skylight on the top was formed with a hexagonal frame on the top of dome, which was arranged by stacking long surfaces of the half-bricks side by side in the perpendicular order to the horizontal plane in the dome thickness. Oculi were formed with brick bond in which the bricks were stacked long

surfaces forming hexagonal openings in the dome thickness. The surfaces of the oculi, lighting cupola and skylight were formed with lime mortar coating including small brick pieces in and plastered with horasan.

**Volume:** Depressed

**Profile:** Depressed arc

**Center number:** 1

**Center height:** 1.20 m

**Dome span:** 2.40 m

**Impost height (dome height):** 0.76 m, 0.58 m, 0.98 m respectively

**Dome thickness:** 0.60-0.65 m

**Impost line:** Raised

**Center - impost relation:** Impost line is 44 cm, 62 cm and 22 cm respectively higher than central line

**Impost - wall relation:** Impost is 11 cm, 22 cm, and 31 cm respectively from wall plane to the interior side

**Dome height / Dome span, Ratio:** 0.76 m / 2.40 m, 0.31; 0.58 m / 2.40 m, 0.24; 0.98 m / 2.40 m, 0.40 respectively

**Dome thickness / Dome span, Ratio:** 0.50 m / 2.40 m, 0.20

**Height of transition element / Dome span, Ratio:** 0.95 m / 2.40 m, 0.39; 0.85 m / 2.40 m, 0.35 respectively

#### **North Halvet Dome (H04)**

A dome covers the square planned space that was juxtaposed to *sıcaklık* main space from north side with 5.08 x 5.08 m interior dimensions. The depressed arch profiled dome has interior span of 4.35 m and a dome height of 1.46 m. Thickness of the dome at the springing level is 40-45 cm and at the top of the dome 35-40 cm. The dome has skylight with a 35 cm opening formed in hexagonal frame of the base and oculi that are in four horizontal rows with equal-size and sixteen oculi in each of the exterior two rows while six oculi in each of the interior two rows on the curved surface of the dome. The oculi all were formed in star shape in the last two interior rows. However, the oculi in the first exterior row were formed in star shaped but two of which were in hexagonal shape, while the oculi in the second exterior row were formed in hexagonal shape but two of which were in star shape alternately. The particular shaped oculi were arranged alternately on the east side of the dome. The oculi are in a form having an opening with 24 cm interior while 18 cm exterior size with narrowing from interior towards exterior and interior surfaces of which were plastered with horasan 1-1.5 cm in thickness. Transition to the dome was provided with squinch at the south corner while with

plain triangles at the other three corners 0.98 m in height. The dome was raised above a circular base 27 cm in interior height while settled directly on the walls on the exterior.



Figure A.44. Tire Yalınayak Hamamı men's section, interior and exterior views of the north corner *halvet* dome.

**Construction technique:** North *halvet* dome was constructed with brick and lime mortar as binder. The dome was covered with horasan plaster 1-1.5 cm in thickness interior while 4-6 cm exterior and coated with a thick layer of horasan mortar 5-8 cm in thickness including small and large pieces of bricks and tiles. The bricks used in the bond are in the dimensions of 28-31 x 19-21 x 3-3.5 cm as whole bricks and 19-21 x 14-16 x 3-3.5 cm as half bricks. In the bond, both vertical and horizontal flush joints have dimensions between 1.5 and 2.5 cm in interior width while between 3 and 5 cm on the exterior.

**Bond type:** Horizontal stacking of the short side faces in places non-parallel rows.

**Lighting elements:** Skylight on the top, oculi on the curved surfaces

**Construction technique:** Skylight and oculi were formed with brick bond as well as the lighting elements on the other *halvet* domes. The surfaces of skylight and oculi were formed with lime mortar coating including small brick pieces and plastered with horasan.

**Volume:** Depressed

**Profile:** Depressed arc

**Center number:** 2

**Distance between two centers:** 26 cm

**Center height:** 2.18 m

**Dome span:** 4.35 m

**Impost height (dome height):** 1.46 m

**Dome thickness:** 0.45 m

**Impost line:** Raised

**Center - impost relation:** Impost line is 72 cm higher than central line

**Impost - wall relation:** Impost is 28-36 cm from wall plane to the interior side

**Dome height / Dome span, Ratio:** 1.46 m / 4.35 m, 0.33

**Dome thickness / Dome span, Ratio:** 0.45 m / 4.35 m, 0.10

**Height of transition element / Dome span, Ratio:** 0.98 m / 4.35 m, 0.22

## The Women's Section

### *Soyunmalık* dome (S02)

*Soyunmalık* dome covers the square planned space with 7.86 x 7.86 m interior dimensions. The depressed profiled dome has an interior span of 7.80 m and a height of 3.20 m. Thickness of the dome at the springing level is 65-70 cm and at the top of the dome 50-55 cm. The dome has a lighting lantern with a circular shaped base and a span of 1.40 m on the top of dome and depressed pointed arched windows with a width of 60 cm at the level of transition zone, placed on the interior walls while on the exterior below drum. Transition to the dome was provided with squinches 1.22 m in height. The dome was raised above a circular base 40-50 cm in interior height while supported by two octagonal exterior drums successively, below with 1.40 m and above with 1.42 m in height.



Figure A.45. Tire Yalınayak Hamamı women's section, interior and exterior views of *soyunmalık* dome.

**Construction technique:** *Soyunmalık* dome was constructed with brick and lime mortar as binder. Now, the dome is plastered interior while coated with concrete on the exterior. The bricks used in the bond are in the dimensions of 30-31 x 26-27 x 3-4 cm as whole bricks and 26-27 x 17-18 x 3-4 cm as half bricks. In the bond, both vertical and horizontal flush joints have dimensions between 1.5 and 2.5 cm in interior width.

**Bond type:** Horizontal and adjacent stacking of the short side faces in parallel rows.

**Lighting elements: Lighting lantern on the top, windows at the transition zone**

**Construction technique:** Lighting lantern was formed with a circular frame at the top of dome and raising the frame by means of brick bond and placing plain surfaces on the frame. Circular frame was arranged by stacking the long surfaces of the bricks in a horizontal line side by side and in perpendicular order to the horizontal plane in the dome thickness. Between the bricks placed in perpendicular order to the horizontal plane and forming the circular frame and the bricks stacked in radial order towards the center of the dome forming the dome thickness, were filled with lime mortar including large and small brick pieces and dust. The windows, arranged in the transition zone at the same level of squinches on the interior wall while at the same level of below drum on the exterior, are the depressed pointed arched openings.

**Volume:** Depressed

**Profile:** Depressed arc

**Center number:** 2

**Distance between two centers:** 36 cm

**Center height:** 3.90 m

**Dome span:** 7.80 m

**Impost height (dome height):** 3.20 m

**Dome thickness:** 0.45 m

**Impost line:** Raised

**Center - impost relation:** Impost line is 70 cm higher than central line

**Impost - wall relation:** Impost is 5-10 cm from wall plane to the interior side

**Dome height / Dome span, Ratio:** 3.20 m / 7.80 m, 0.41

**Dome thickness / Dome span, Ratio:** 0.70 m / 7.80 m, 0.09

**Height of transition element / Dome span, Ratio:** 1.22 m / 7.80 m, 0.15



## Catalogue No: 8 – Construction Name: Tire Yeniceköy Hamamı

### 1. Construction Date

The *hamam* has no inscription. It is stated by A. M. Armağan that the construction was a part of Büyükkale Mosque Foundation buildings built by İsa Bey, the young son of Aydınöglü Mehmet Bey and that it may have been built in 1382 in the same construction date of İsa Bey Fountain located in Büyükkale (Armağan 1983). The *hamam* can be dated back to the 15<sup>th</sup> century taking into consideration the use of Turkish triangles provide transition to the domes, the use of muqarnas decoration in *sıcaklık* main space, the trace of yashmak in the transition from *soyunmalık* to *ılıklık* space, and the statement of A. M. Armağan (Armağan 1983; Önge 1995; Çakmak 2002).



Figure A.46. Tire Yeniceköy Hamamı, the general view of superstructure (2008).

### 2. Plan Characteristics

The *hamam* is composed in a plan organization from north towards south *soyunmalık*, rectangular planned *ılıklık*, *sıcaklık* main space, and two *halvets*. In addition, in the south part there is a rectangular planned water reservoir juxtaposed to the south *halvets* from south direction. *Ilıklık* sub-unit located at the west of *ılıklık* is projected at the west surface of the bath. *Soyunmalık* is lost today, but from west part there are some wall remains. Square planned *ılıklık* sub-unit located at the west part of *ılıklık* main space, *sıcaklık* main space middle unit and two *halvets* were covered with dome while rectangular planned *ılıklık* main space, the sub-units of

*sıcaklık* main space from east and west sides and water reservoir were covered with barrel vault. It can be evaluated within the type of plan that has elongated rectangular *sıcaklık* with domed central unit and two *halvets* (Eyice 1960).

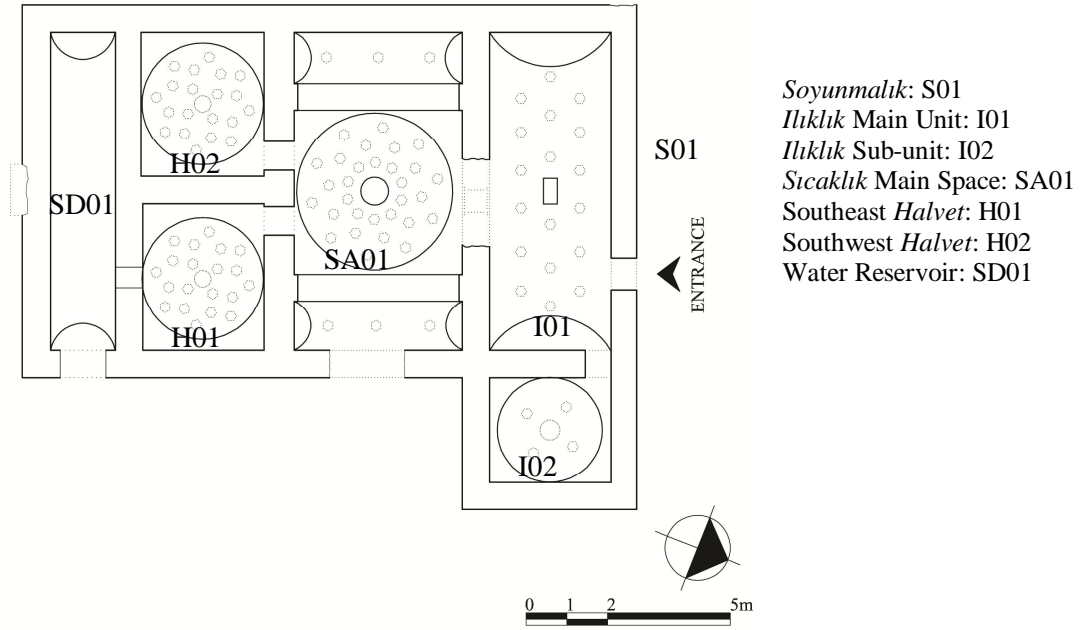

Figure A.47. Tire Yeniceköy Hamamı, Plan (2008).

### 3. Definition of Domes

#### *Ilıklık* sub-unit dome (I02)

Dome of the space located at the east of *ilıklık* covers the square planned space projected at the west surface of the bath with 2.26 x 2.27 m interior dimensions. The depressed circular profiled dome has interior span with 2.20 m and a dome height with 0.94 m. Thickness of the dome at the springing level is 40-45 cm and at the top of the dome 35-40 cm. The dome has a lighting cupola with an octagonal shaped frame, the span of which is 40 cm, and four oculi that are in one horizontal row and the equal-size pentagonal shape on the curved surface of the dome. The oculi are in a form having opening with 17-18 cm interior while 13-14 cm exterior size with narrowing from interior towards exterior and the interior surfaces were plastered with horasan 1-1.5 cm in thickness. Transition to the dome was provided with plain triangles 85 cm in height. The dome was raised above a circular base 20 cm in interior height while settled on the walls directly on the exterior.



Figure A.48. Tire Yeniceköy Hamamı, interior and exterior views of southeast *İliklik* sub-unit dome.

**Construction technique:** *İliklik* sub-unit dome was constructed with brick and lime mortar as binder. The dome was covered with horasan plaster 1-1.5 cm in interior thickness while 5-8 cm on the exterior, but today the dome is coated with a layer of concrete on the horasan plaster. The bricks used in the bond are in the dimensions of 27-28 x 21-22 x 3-3.5 cm as whole bricks and 21-22 x 14-15 x 3-3.5 cm and 27-28 x 11-12 x 3-3.5 cm as half bricks. In the bond, both vertical and horizontal flush joints have dimensions between 1.5 and 2.5 cm in interior width while between 2 and 5 cm on the exterior.

**Bond type:** Horizontal stacking of the short side faces in places non-parallel rows.

**Lighting elements:** Lighting cupola on the top, oculi on the curved surfaces

**Construction technique:** Lighting cupola and oculi were formed with brick bond. Lighting cupola was formed with an octagonal frame on the top of dome, which was arranged by stacking long surfaces of the half-bricks side by side in perpendicular order to the horizontal plane in the dome thickness. Between the half-bricks placed in perpendicular order to the horizontal plane and forming the octagonal frame and the whole bricks stacked radial towards the center of the dome forming the dome thickness were filled with lime mortar including brick pieces and dust. Today, upper side of cupola is covered. The surface was covered with horasan plaster 1-1.5 cm in interior thickness while 5-8 cm on the exterior. Oculi were formed with brick bond in which the bricks were stacked long surfaces forming pentagonal shape openings in the dome thickness. The surfaces of the oculi and lighting cupola were formed with lime mortar coating including small brick pieces and plastered with horasan.

**Volume:** Depressed

**Profile:** Depressed arc

**Center number:** 1

**Center height:** 1.10 m

**Dome span:** 2.20 m

**Impost height (dome height):** 0.94 m

**Dome thickness:** 0.45 m

**Impost line:** Raised

**Center - impost relation:** Impost line is 16 m higher than central line

**Impost - wall relation:** Impost is 5-10 cm from wall plane to the interior side

**Dome height / Dome span, Ratio:** 0.94 m / 2.20 m, 0.42

**Dome thickness / Dome span, Ratio:** 0.45 m / 2.20 m, 0.20

**Height of transition element / Dome span, Ratio:** 0.85 m / 2.20 m, 0.38

#### ***Sıcaklık* main space, central unit dome (SA01)**

The central unit of rectangular planned *sıcaklık* main space was covered with a dome while the side units were covered with barrel vaults. The central unit dome covers the square space with 3.80 x 3.87 m interior dimensions. The depressed arch profiled dome has an interior span of 3.70 m and a height of 1.46 m. Thickness of the dome at the springing level is 40-45 cm and at the top of the dome 35-40 cm. The dome has a lighting cupola, which consists of hexagonal shaped oculi, with a 70-80 cm opening formed in circular frame of the base and oculi that are in three horizontal rows with equal-size hexagonal shape and ten oculi in each row on the curved surface of the dome. The oculi are in a form having an opening with 17-18 cm interior while 13-14 cm exterior size with narrowing from interior towards exterior and interior surfaces of which were plastered with horasan 1-1.5 cm in thickness. Transition to the dome was provided with pendentives 1.03 m in height. The dome was raised above an octagonal base 68 cm in interior height while supported by an octagonal exterior drum with 45-60 cm in height.



Figure A.49. Tire Yeniceköy Hamamı, interior and exterior views of southeast *sıcaklık* main space dome.

**Construction technique:** Dome of *sıcaklık* main space central unit was constructed with brick and lime mortar as binder. The dome was covered with horasan plaster 1-1.5 cm in interior thickness while 4-5 cm on the exterior, but today the dome is coated with a layer of concrete on the horasan plaster. The bricks used in the bond are in the dimensions of 27-28 x 21-22 x 3-3.5 cm as whole bricks and 21-22 x 14-15 x 3-3.5 cm and 27-28 x 11-12 x 3-3.5 cm as half bricks. In the bond, both vertical and horizontal flush joints have dimensions between 1.5 and 2.5 cm in interior width while between 3 and 5 cm in the exterior.

**Bond type:** Horizontal stacking of the short side faces in places non-parallel rows.

**Lighting elements: Lighting cupola on the top, oculi on the curved surfaces**

**Construction technique:** Lighting cupola and oculi were formed with brick bond. Lighting cupola was formed with a circular frame on the top of dome, which was arranged by stacking long surfaces of the half-bricks side by side in perpendicular order to the horizontal plane in the dome thickness. Between the half-bricks forming the circular frame and the whole bricks stacked radial towards the center of the dome forming the dome thickness were filled with lime mortar including brick pieces and dust. Muqarnas decorations formed with horasan plaster were arranged on the base of lighting cupola. The surface was covered with horasan plaster 1-1.5 cm in interior thickness while 5-8 cm on the exterior. Oculi were formed with brick bond in which the bricks were stacked long surfaces forming hexagonal shaped openings in the dome thickness. The surfaces of the oculi and lighting cupola were formed with lime mortar coating including small brick pieces and plastered with horasan.

**Volume:** Depressed

**Profile:** Depressed arc

**Center number:** 1

**Center height:** 1.85 m

**Dome span:** 3.70 m

**Impost height (dome height):** 1.46 m

**Dome thickness:** 0.45 m

**Impost line:** Raised

**Center-impost relation:** Impost line is 39 m higher than central line

**Impost - wall relation:** Impost is 5-10 cm from wall plane to the interior side

**Dome height / Dome span, Ratio:** 1.46 m / 3.70 m, 0.39

**Dome thickness / Dome span, Ratio:** 0.45 m / 3.70 m, 0.12

**Height of transition element / Dome span, Ratio:** 1.03 m / 3.70 m, 0.27

### **Southeast *halvet* dome (H01)**

Dome covers the square planned space that was juxtaposed to *sıcaklık* main space from east side with 3.55 x 3.61 m interior dimensions. The depressed arch profiled dome has interior span of 3.50 m and a dome height of 1.57 m. Thickness of the dome at the springing level is 40-45 cm and at the top of the dome 35-40 cm. The dome has lighting cupola, on which hexagonal shaped oculi were placed and coated with concrete today, with a 60 cm opening formed in circular frame of the base and oculi that are in three horizontal rows placed as equal-size hexagonal shape eight oculi in the exterior two rows and four in the interior row on the curved surface of the dome. The oculi are in a form having an opening with 23-24 cm interior while 17-18 cm exterior size with narrowing from interior towards exterior and interior surfaces of which were plastered with horasan 1-1.5 cm in thickness. Transition to the dome was provided with Turkish triangles 0.92 m in height. The dome was raised above a circular base 40 cm in interior height while settled directly on the walls on the exterior.



Figure A.50. Tire Yeniceköy Hamamı, interior and exterior views of southeast *halvet* dome.

**Construction technique:** Southeast *halvet* dome was constructed with brick and lime mortar as binder. The dome was covered with horasan plaster 1-1.5 cm in interior thickness while 6-8 cm on the exterior, but today the dome is coated with a layer of concrete on the horasan plaster. The bricks used in the bond are in the dimensions of 27-28 x 21-22 x 3-3.5 cm as whole bricks and 21-22 x 14-15 x 3-3.5 cm and 27-28 x 11-12 x 3-3.5 cm as half bricks. In the bond, both vertical and horizontal flush joints have dimensions between 1.5 and 2.5 cm in interior width while between 3 and 4 cm in the exterior.

**Bond type:** Horizontal stacking of the short side faces in places non-parallel rows.

**Lighting elements: Lighting cupola on the top, oculi on the curved surfaces**

**Construction technique:** Lighting cupola and oculi were formed with brick bond. Lighting cupola was formed with a circular frame on the top of dome, which was arranged by stacking long surfaces of the half-bricks side by side in perpendicular order to the horizontal plane in the

dome thickness. Today, upper side of cupola is covered. The oculi were formed with brick bond in which the bricks were stacked long surfaces forming hexagonal shaped openings in the dome thickness. The surfaces of the oculi and lighting cupola were formed with lime mortar coating including small brick pieces and plastered with horasan.

**Volume:** Depressed

**Profile:** Depressed arc

**Center number:** 1

**Center height:** 1.75 m

**Dome span:** 3.50 m

**Impost height (dome height):** 1.57 m

**Dome thickness:** 0.45 m

**Impost line:** Raised

**Center-impost relation:** Impost line is 18 m higher than central line

**Impost - wall relation:** Impost is 5-8 cm from wall plane to the interior side

**Dome height / Dome span, Ratio:** 1.57 m / 3.50 m, 0.44

**Dome thickness / Dome span, Ratio:** 0.45 m / 3.50 m, 0.12

**Height of transition element / Dome span, Ratio:** 0.92 m / 3.50 m, 0.26

#### **Southwest *halvet* dome (H02)**

Dome covers the square planned space that was juxtaposed to *sıcaklık* main space from west side with 3.55 x 3.57 m interior dimensions. The depressed arch profiled dome has interior span of 3.50 m and a dome height of 1.35 m. Thickness of the dome at the springing level is 40-45 cm and at the top of the dome 35-40 cm. The dome has lighting cupola, on which hexagonal shaped oculi were placed and coated with concrete today, with a 55-60 cm opening formed in circular frame of the base and oculi that are in three horizontal rows placed as equal-size hexagonal shape eight oculi in the exterior two rows and four in the interior row on the curved surface of the dome. The oculi are in a form having an opening with 23-24 cm interior while 17-18 cm exterior size with narrowing from interior towards exterior and interior surfaces of which were plastered with horasan 1-1.5 cm in thickness. Transition to the dome was provided with pendentives 0.99 m in height. The dome was raised above a circular base 30 cm in interior height while settled directly on the walls on the exterior.



Figure A.51. Tire Yeniceköy Hamamı, interior and exterior views of southwest *halvet* dome.

**Construction technique:** Southwest *halvet* dome was constructed with brick and lime mortar as binder. The dome was covered with horasan plaster 1-1.5 cm in interior thickness while 6-8 cm on the exterior, but today the dome is coated with a layer of concrete on the horasan plaster. The bricks used in the bond are in the dimensions of 27-28 x 21-22 x 3-3.5 cm as whole bricks and 21-22 x 14-15 x 3-3.5 cm and 27-28 x 11-12 x 3-3.5 cm as half bricks. In the bond, both vertical and horizontal flush joints have dimensions between 1.5 and 2.5 cm in interior width while between 3 and 4 cm on the exterior.

**Bond type:** Horizontal stacking of the short side faces in places non-parallel rows.

**Lighting elements:** Lighting cupola on the top, oculi on the curved surfaces

**Construction technique:** Lighting cupola and oculi were formed with brick bond as the lighting elements in southeast *halvet* dome.

**Volume:** Depressed

**Profile:** Depressed arc

**Center number:** 1

**Center height:** 1.75 m

**Dome span:** 3.50 m

**Impost height (dome height):** 1.35 m

**Dome thickness:** 0.45 m

**Impost line:** Raised

**Center-impost relation:** Impost line is 40 m higher than central line

**Impost - wall relation:** Impost is 5-8 cm from wall plane to the interior side

**Dome height / Dome span, Ratio:** 1.35 m / 3.50 m, 0.38

**Dome thickness / Dome span, Ratio:** 0.45 m / 3.50 m, 0.12

**Height of transition element / Dome span, Ratio:** 0.99 m / 3.50 m, 0.28



**Catalogue No: 9 – Construction Name: Ulaş Hamamı**

**1. Construction Date**

The *hamam* has no inscription, however, it may be dated back to the 16<sup>th</sup> century taking into consideration enlargement of the square planned *ılıklik* central unit with barrel vaulted two side units and the use of star shaped oculi on the domes (Önge 1995; Reyhan 2004).



Figure A.52. Ulaş Hamamı, a general view of superstructure (2004).

**2. Plan Characteristics**

The *hamam* is composed in a plan organization from south to north a rectangular planned *ılıklik* / *sıcaklık* main space and two corner *halvets*. In addition, in the northeast part there is a rectangular planned water reservoir. The square planned central unit of *ılıklik* / *sıcaklık* main space and corner *halvets* were covered with domes while the rectangular planned units and water reservoir were covered with vaults. The *hamam* can be evaluated in the plan type of elongated *sıcaklık* with domed central unit and two corner *halvets* (Eyice 1960).

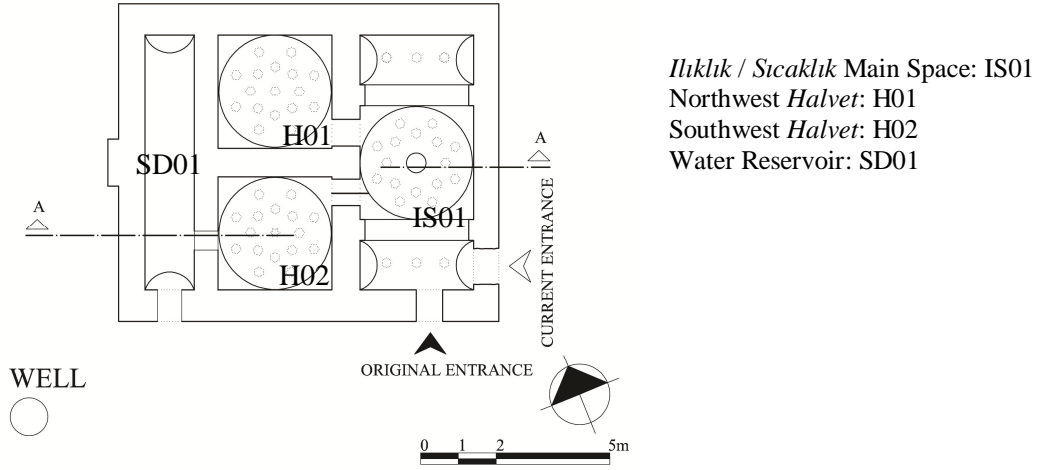

Figure A.53. Ulamiş Hamamı, Plan (2004).

### 3. Definition of Domes

#### *Ilıklık / Sıcaklık* Main Space Dome (IS01)

The northeast and southwest side units of the rectangular planned *ilıklık / sıcaklık* main space that has a dimension of 2.90 x 5.60 m were covered with barrel vaults while the central unit was covered with a dome. The central unit dome covers the square space with 2.90 x 2.95 m interior dimensions. The depressed arch profiled dome has an interior span of 2.71 m and a height of 1.26 m. The thickness at the springing level, as well as, at the top of the dome is 35-40 cm. The dome has lighting cupola with a 60 cm opening and oculi that are in two circular rows with equal-size hexagonal shape and eight oculi in each row on the curved surface of the dome. The oculi are in a form having an opening with 17-18 cm interior while 13-14 cm exterior size with narrowing from interior towards exterior. The interior surface was plastered with horasan 1-1.5 cm in thickness. Transition to the dome was provided with pendentives 1.15 m in height. The dome was raised above a circular base 26 cm in interior height while supported by an octagonal exterior drum with 65 cm in height.



Figure A.54. Ulamiş Hamamı, interior and exterior views of *ılıklık / sıcaklık* main space dome.

**Construction technique:** *Ilıklık / sıcaklık* main space dome was constructed with brick and lime mortar as binder. The dome was covered with horasan plaster 1-1.5 cm in interior thickness while 3-5 cm on the exterior. The bricks used in the bond are in the dimensions of 30-31 x 21-22 x 3-4 cm as whole bricks and 21-22 x 14-15 x 3-4 cm as half bricks. Both vertical and horizontal flush joints have dimensions between 1.5 and 2.5 cm in interior width, while between 4 and 6 cm on the exterior.

**Bond type:** Horizontal stacking of the short side faces in places non-parallel rows.

**Lighting elements: Lighting cupola on the top, oculi on the curved surfaces**

**Construction technique:** Lighting cupola and oculi were formed with brick bond. Lighting cupola was formed with a circular frame on the top of dome, which was arranged by stacking long surfaces of the half-bricks side by side in perpendicular order to the horizontal plane in the dome thickness. Between the half-bricks forming the circular frame and the whole bricks stacked radial towards the center of the dome forming the dome thickness were filled with lime mortar including brick pieces and dust. The curved upper side of lighting cupola was formed by stacking short surfaces of half-brick radial towards the center of the cupola forming the cupola thickness. Circular shaped oculi, smaller than the oculi placed on the surface of dome, were arranged on the surface of the lighting cupola and a star shaped oculus were arranged on the top of the lighting cupola. The surface was covered with horasan plaster 1-1.5 cm in interior thickness while 3-5 cm on the exterior. Oculi were formed with brick bond in which the bricks were stacked long surfaces forming hexagonal shaped openings in the dome thickness. The surfaces of the oculi and lighting cupola were formed with lime mortar coating including small brick pieces and plastered with horasan.

**Volume:** Depressed

**Profile:** Depressed arc

**Center number:** 2

**Distance between two centers:** 16 cm

**Center height:** 1.36 m

**Dome span:** 2.71 m

**Impost height (dome height):** 1.26 m

**Dome thickness:** 0.40 m

**Impost line:** Raised

**Center-impost relation:** Impost line is 10 cm higher than central line

**Impost - wall relation:** Impost is 10 cm from wall plane to the interior side

**Dome height / Dome span, Ratio:** 1.26 m / 2.71 m, 0.46

**Dome thickness / Dome span, Ratio:** 0.40 m / 2.71 m, 0.14

**Height of transition element / Dome span, Ratio:** 1.15 m / 2.71 m, 0.42

#### **Northwest *Halvet* Dome (H01)**

Dome covers the square planned space that was juxtaposed to *sıcaklık* main space from northwest side with 2.98 x 3.09 m interior dimensions. The depressed arch profiled dome has interior span of 2.78 m and a dome height of 1.10 m. Thickness of the dome at the springing level is 40-45 cm and at the top of the dome 35-40 cm. The dome has a skylight with a 25 cm opening formed in a hexagonal frame at the base and oculi that are in two horizontal rows placed as equal-sized hexagonal shaped eight oculi in each row on the curved surface of the dome. The oculi have an opening with 16-17 cm interior while 13 cm exterior sizes with narrowing from interior towards exterior. The interior surface was plastered with horasan 1-1.5 cm in thickness. Transition to the dome was provided with pendentives 1.62 m in height. The dome was raised above a circular base 25 cm in interior height while settled directly on the walls on the exterior.



Figure A.55. Ulamiş Hamamı, interior and exterior views of northeast *halvet* dome.

**Construction technique:** Northeast *halvet* dome was constructed with brick and lime mortar as binder. The dome was covered with horasan plaster 1-1.5 cm in interior thickness while 6-8 cm exterior. The bricks used in the bond are in the dimensions of 30-31 x 21-22 x 3-4 cm as whole bricks and 21-22 x 14-15 x 3-4 cm as half bricks. Both vertical and horizontal flush joints have dimensions between 1.5 and 2.5 cm in interior width, while between 3 and 4 cm on the exterior.

**Bond type:** Horizontal stacking of the short side faces in places non-parallel rows.

**Lighting elements: Skylight on the top, oculi on the curved surfaces**

**Construction technique:** Skylight and oculi were formed with brick bond. Skylight was formed with a hexagonal frame on the top of dome, which was arranged by stacking long surfaces of the half-bricks side by side in perpendicular order to the horizontal plane in the dome thickness. Between the half-bricks forming the hexagonal frame and whole bricks stacked radial towards the center of the dome forming the dome thickness were filled with lime mortar including brick pieces and dust. Oculi were formed with brick bond in which the bricks were stacked long surfaces forming hexagonal shaped openings in the dome thickness. The surfaces of the oculi and skylight were formed with lime mortar coating including small brick pieces and plastered with horasan. The surface was covered with horasan plaster 1-1.5 cm in interior thickness while 3-5 cm on the exterior.

**Volume:** Depressed

**Profile:** Depressed arc

**Center number:** 2

**Distance between two centers:** 15 cm

**Center height:** 1.39 m

**Dome span:** 2.78 m

**Impost height (dome height):** 1.10 m

**Dome thickness:** 0.45 m

**Impost line:** Raised

**Center-impost relation:** Impost line is 29 cm higher than central line

**Impost - wall relation:** Impost is 8-10 cm from wall plane to the interior side

**Dome height / Dome span, Ratio:** 1.10 m / 2.78 m, 0.39

**Dome thickness / Dome span, Ratio:** 0.45 m / 2.78 m, 0.16

**Height of transition element / Dome span, Ratio:** 1.62 m / 2.78 m, 0.58

**Southwest *Halvet* Dome (H01)**

Dome covers the square planned space that was juxtaposed to *sıcaklık* main space from southwest side with 3.02 x 3.10 m interior dimensions. The depressed pointed arch profiled

dome has interior span of 2.87 m and a dome height of 1.30 m. Thickness of the dome at the springing level is 40-45 cm and at the top of the dome 35-40 cm. The dome has a skylight with a 25 cm opening formed in star shape and oculi that are in two horizontal rows placed as equal-size hexagonal shape eight oculi in each row on the curved surface of the dome. The oculi are in a form having an opening with 16-17 cm interior while 13 cm exterior sizes with narrowing from interior towards exterior. The interior surface was plastered with horasan 1-1.5 cm in thickness. Transition to the dome was provided with pendentives 1.60 m in height. The dome was raised above a circular base 25 cm in interior height while settled directly on the walls on the exterior.



Figure A.56. Ulamiş Hamamı, interior and exterior views of northwest *halvet* dome.

**Construction technique:** Northwest *halvet* dome was constructed with brick and lime mortar as binder. The dome was covered with horasan plaster 1-1.5 cm in interior thickness while 6-8 cm on the exterior. The bricks used in the bond are in the dimensions of 30-31 x 21-22 x 3-4 cm as whole bricks and 21-22 x 14-15 x 3-4 cm as half bricks. Both vertical and horizontal flush joints have dimensions between 1.5 and 2.5 cm in interior width, while between 3 and 4 cm on the exterior.

**Bond type:** Horizontal stacking of the short side faces in places non-parallel rows.

**Lighting elements: Skylight on the top, oculi on the curved surfaces**

**Construction technique:** Skylight and oculi were formed with brick bond. Skylight was formed in a star shape opening on the top of dome, which was arranged by stacking long surfaces of the half-bricks side by side in perpendicular order to the horizontal plane in the dome thickness. Between the half-bricks forming the star shaped opening and whole bricks stacked radial towards the center of the dome forming the dome thickness were filled with lime mortar including brick pieces and dust. Oculi were formed with brick bond in which the bricks were stacked long surfaces forming hexagonal shaped openings in the dome thickness. The

surfaces of the oculi and the skylight were formed with lime mortar coating including small brick pieces and plastered with horasan. The surface was covered with horasan plaster 1-1.5 cm in interior thickness while 3-5 cm on the exterior.

**Volume:** Depressed

**Profile:** Depressed arc

**Center number:** 2

**Distance between two centers:** 15 cm

**Center height:** 1.44 m

**Dome span:** 2.87 m

**Impost height (dome height):** 1.30 m

**Dome thickness:** 0.45 m

**Impost line:** Raised

**Center-impost relation:** Impost line is 14 cm higher than central line

**Impost - wall relation:** Impost is 5-7 cm from wall plane to the interior side

**Dome height / Dome span, Ratio:** 1.30 m / 2.87 m, 0.45

**Dome thickness / Dome span, Ratio:** 0.45 m / 2.87 m, 0.15

**Height of transition element / Dome span, Ratio:** 1.60 m / 2.87 m, 0.55

**Catalogue No: 10 – Construction Name: Düzce (Hereke) Hamamı**

**1. Construction Date**

The *hamam* has no inscription, however, it may be dated back to the 16<sup>th</sup> century taking into consideration squinches that provide transition to the dome and two rows of windows on the lower and upper levels in *soyunmalık*, and the enlargement of the square planned domed *ılıklik* central unit with barrel vaulted two side units (Önge 1995, Reyhan 2004).



Figure A.57. Düzce (Hereke) Hamamı, a general view of superstructure (2004).

**2. Plan Characteristics**

Plan organization of the hamam is composed of from south to north *soyunmalık*, a rectangular planned *ılıklik / sıcaklık* main space and three *halvets*. In addition, in the south part there is a rectangular planned water reservoir. *Soyunmalık*, the square planned central unit of *ılıklik / sıcaklık* main space and *halvets* were covered with domes while the rectangular planned units and water reservoir were covered with vaults. However, today the dome of the northeast and southwest *halvets* has collapsed. Hamam can be evaluated in the plan type of elongated *sıcaklık* with domed central unit and two *halvets* (Eyice 1960), but here there are three *halvets*.



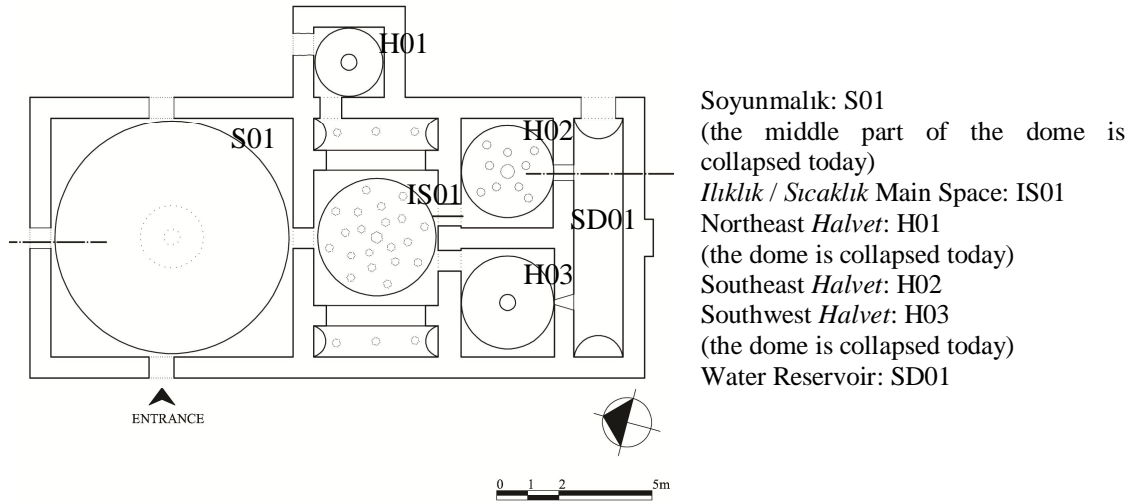

Figure A.58. Düzce (Hereke) Hamamı, Plan (2004).

### 3. Definition of Domes

#### *Soyunmalık* Dome (S01)

*Soyunmalık* dome covers the square space with 7.55 x 7.80 m interior dimensions. The semi-circular arch profiled dome, the middle part of which is collapsed today, has an interior span of 7.25 m and a height of 3.15 m. Thickness of the dome at the springing level is 60-65 cm and at the top of the dome 35-40 cm. Depressed pointed profiled windows, 70 cm in width, were arranged at the springing level of the dome on the curved surfaces. Transition to the dome was provided with squinches 2.43 m in height. The dome was raised above a circular base 31 cm in interior height while supported by an octagonal exterior drum with 0.85-1.20 m in height.



Figure A.59. Düzce (Hereke) Hamamı, interior and exterior views of *soyunmalık* dome.

**Construction technique:** *Soyunmalık* dome was constructed with brick and lime mortar as binder. The dome was covered with horasan plaster 1-1.5 cm in interior thickness while 3-5 cm

in the exterior. The bricks used in the bond are in the dimensions of 30-31 x 21-22 x 3-4 cm as whole bricks and 30-31 x 10-11 x 3-4 cm and 21-22 x 15-16 x 3-4 cm as half bricks. Both vertical and horizontal flush joints have dimensions between 1.5 and 2.5 cm in interior width, while between 2.5 and 5 cm on the exterior.

**Bond type:** Horizontal and adjacent stacking of the short side faces in parallel rows

**Lighting elements: Windows at the springing level**

**Construction technique:** The windows arranged at the springing level of soyunmalık dome that has partially collapsed at the top are depressed pointed arched openings 70 cm in width. The interior part of opening was constructed with brick bond while the exterior part of the opening, a part of exterior drum, using masonry wall bonding technique and rubble and large pieces of bricks in joints on the north wall, one row of brick and one row of reused cut stone encircled by brick at the corners of exterior walls (Reyhan 2004). The depressed pointed arches of the window in all the section of the opening were constructed only with brick and lime mortar as binder. In addition, both edges of the opening in the section of exterior supporting element (drum) were built with brick bond as well as in the interior part of the dome.

**Volume:** Slightly depressed semi-circular

**Profile:** Slightly depressed semi-circular arc

**Center number:** 1

**Center height:** 3.63 m

**Dome span:** 7.25 m

**Impost height (dome height):** 3.15 m

**Dome thickness:** 0.65 m

**Impost line:** Raised

**Center-impost relation:** Impost line is 48 cm higher than central line

**Impost - wall relation:** Impost is 24 cm from wall plane to the interior side

**Dome height / Dome span, Ratio:** 3.15 m / 7.25 m, 0.43

**Dome thickness / Dome span, Ratio:** 0.65 m / 7.25 m, 0.09

**Height of transition element / Dome span, Ratio:** 2.43 m / 7.25 m, 0.33

***Ilıklık / Sıcaklık Main Space Dome (IS01)***

The side units of rectangular planned *ilıklık / sıcaklık* main space that has a dimension of 3.77 x 7.80 m were covered with barrel vaults while central unit was covered with a dome. The central unit dome covers the square space with 3.70 x 3.77 m interior dimensions. The depressed arch profiled dome has an interior span of 3.50 m and a height of 1.76 m. Thickness of the dome at the springing level is 40-45 cm and at the top of the dome 35-40 cm. The dome

has a skylight with a 40 cm opening formed in octagonal frame of the base and oculi that are in three horizontal rows with equal-size hexagonal shape four oculi in the interior row and eight in two exterior rows on the curved surface of the dome. The oculi are in a form having an opening 23-24 cm interior while 17-18 cm exterior size with narrowing from interior towards exterior and interior surfaces of which were plastered with horasan 1-1.5 cm in thickness. Transition to the dome was provided with pendentives 1.55 m in height. The dome was raised above an octagonal base 26 cm in interior height while supported by an octagonal exterior drum 35-45 cm in height.



Figure A.60. Düzce (Hereke) Hamamı, interior and exterior views of *ılıklık / sıcaklık* main space dome.

**Construction technique:** *Ilıklık / sıcaklık* main space dome was constructed with brick and lime mortar as binder. The dome was covered with horasan plaster 1-1.5 cm in interior thickness while 3-5 cm exterior. The bricks used in the bond are in the dimensions of 30-31 x 21-22 x 3-4 cm as whole bricks and 30-31 x 10-11 x 3-4 cm and 21-22 x 15-16 x 3-4 cm as half bricks. Both vertical and horizontal flush joints have dimensions between 1.5 and 2.5 cm in interior width, while between 2 and 5 cm on the exterior.

**Bond type:** Horizontal stacking of the short side faces in places non-parallel rows.

**Lighting elements: Skylight on the top, oculi on the curved surfaces**

**Construction technique:** Skylight and oculi were formed with brick bond. Skylight was formed with an octagonal shaped opening on the top, which was arranged by stacking long surfaces of the half-bricks side by side in perpendicular order to the horizontal plane in the dome thickness. Between the half-bricks forming the octagonal opening and the whole bricks stacked radial towards the center of the dome forming the dome thickness were filled with lime mortar including brick pieces and dust. Oculi were formed with brick bond in which the bricks were stacked long surfaces forming hexagonal shaped openings in the dome thickness. The surfaces of the oculi and the skylight were formed with lime mortar coating including small brick pieces and plastered with horasan. The surface was covered with horasan plaster 1-1.5 cm in interior thickness while 3-5 cm on the exterior.

**Volume:** Semi-circular

**Profile:** Semi-circular arc

**Center number:** 1

**Center height:** 1.75 m

**Dome span:** 3.50 m

**Impost height (dome height):** 1.76 m

**Dome thickness:** 0.45 m

**Impost line:** Raised

**Center-impost relation:** Impost line is in the same level of central line

**Impost - wall relation:** Impost is 13-14 cm from wall plane to the interior side

**Dome height / Dome span, Ratio:** 1.76 m / 3.50 m, 0.50

**Dome thickness / Dome span, Ratio:** 0.45 m / 3.50 m, 0.12

**Height of transition element / Dome span, Ratio:** 1.55 m / 3.50 m, 0.44

**Southeast Halvet Dome (H01)**

Dome covers the square planned space that was juxtaposed to *sıcaklık* main space from southeast side with 3.05 x 3.09 m interior dimensions. The slightly depressed semi-circular arch profiled dome has interior span of 2.90 m and a dome height of 1.40 m. Thickness of the dome at the springing level is 40-45 cm and at the top of the dome 37-42 cm. The dome has lighting cupola with a 40 cm opening formed in circular frame at the base and oculi that are in two horizontal rows placed as equal-size circular shape five oculi in the interior row and four in the exterior on the curved surface of the dome. The oculi are in a form having an opening 23-24 cm interior while 19-20 cm exterior with narrowing from interior towards exterior. The interior surface was plastered with horasan 1-1.5 cm in thickness. Transition to the dome was provided

with two slices of plain triangles 65 cm in height. The dome was raised above a circular base 25 cm in interior height while settled directly on the walls on the exterior.



Figure A.61. Düzce (Hereke) Hamamı, interior and exterior views of southeast *halvet* dome.

**Construction technique:** Southeast *halvet* dome was constructed with brick and lime mortar as binder. The surfaces of dome were covered with horasan plaster 1-1.5 cm in interior thickness while 6-8 cm in the exterior. The bricks used in the bond are in the dimensions of 30-31 x 21-22 x 4-4.5 cm as whole bricks and 30-31 x 10-11 x 4-4.5 cm and 21-22 x 15-16 x 4-4.5 cm as half bricks. Both vertical and horizontal flush joints have dimensions between 1.5 and 2.5 cm in interior width, while between 3 and 4 cm on the exterior.

**Bond type:** Horizontal stacking of the short side faces in places non-parallel rows.

**Lighting elements: Lighting cupola on the top, oculi on the curved surfaces**

**Construction technique:** Part of the lighting cupola in the dome section on the top and circular shaped oculi was formed with terracotta material while the upper part of the lighting cupola with brick bond. Lighting cupola on the top was formed with a circular frame at the top of the dome with 40 cm span, was arranged with circular shaped terracotta and covered with stacking long surfaces of the half-bricks side by side in perpendicular order to the horizontal plane in the dome thickness. Among the terracotta material, the half-bricks placed in perpendicular order to the horizontal plane, and the whole bricks stacked radial towards the center of the dome forming the dome thickness were filled with lime mortar including brick pieces and dust. Upper side of cupola was formed with brick bond arranged with half-bricks 15 cm in thickness. Oculi, made of terracotta material and narrowed from interior to exterior in a truncated conical form, have 23-24 cm interior span while 19-20 cm exterior, 38 cm length and 1.5 cm thickness. Between the bricks stacked radial towards the center of the dome forming the dome thickness and the terracotta oculi were filled with lime mortar including brick pieces and dust. The surfaces of the terracotta pipes were plastered with horasan 0.5-1 cm in thickness.

**Volume:** Slightly depressed semi-circular

**Profile:** Slightly depressed semi-circular arc

**Center number:** 1

**Center height:** 1.45 m

**Dome span:** 2.90 m

**Impost height (dome height):** 1.40 m

**Dome thickness:** 0.45 m

**Impost line:** Raised

**Center-impost relation:** Impost line is 5 cm higher than central line

**Impost - wall relation:** Impost is 8-10 cm from wall plane to the interior side

**Dome height / Dome span, Ratio:** 1.40 m / 2.90 m, 0.48

**Dome thickness / Dome span, Ratio:** 0.45 m / 2.90 m, 0.15

**Height of transition element / Dome span, Ratio:** 0.65 m / 2.90 m, 0.22

### **1. Construction Date**

The *hamam* has no inscription. It can be dated back to the 16<sup>th</sup> century taking into consideration the window in *soyunmalık*, squinches that provide transition to dome in *soyunmalık* and in the west section of *ılıklik*, and the enlargement of the square planned domed *ılıklik* central unit with two side sections, one of which is covered with a panelled vault and the other is covered with a dome (Önge 1995; Reyhan 2004).



Figure A.62. Seferihisar Büyük Hamam, a general view of superstructure (2004).

### **2. Plan Characteristics**

The *hamam* is composed in a plan organization from north to south *soyunmalık*, a rectangular planned *ılıklik*, *sıcaklık* main space and two corner *halvets*. In addition, in the south part there is a rectangular planned water reservoir. The square planned *soyunmalık*, central unit of *ılıklik* and *sıcaklık* main space, the west sub-unit of *ılıklik* and corner *halvets* were covered with domes while the rectangular planned *ılıklik* east sub-unit, the side units of *sıcaklık* main space and water reservoir were covered with vaults. The *hamam* can be evaluated in the plan type of elongated *sıcaklık* with domed central unit and two *halvets* (Eyice 1960).

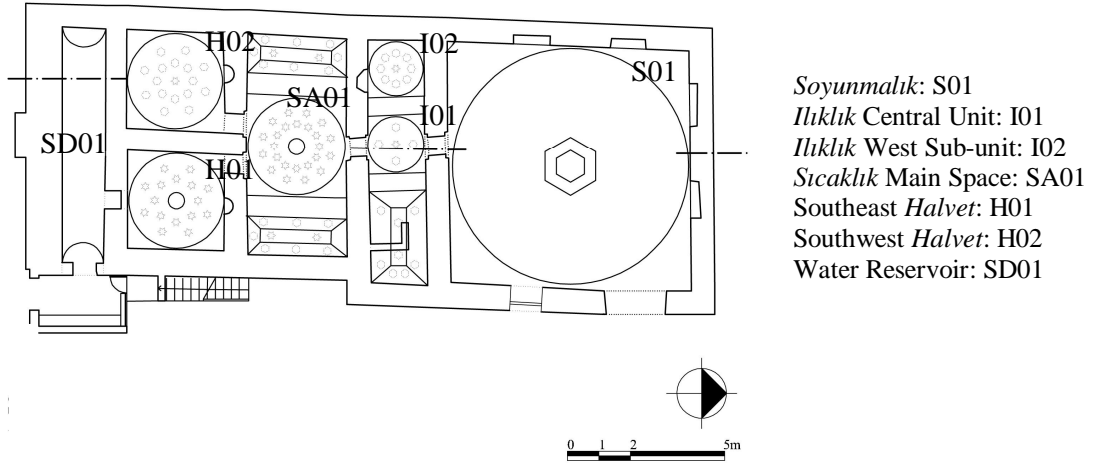

Figure A.63. Seferihisar Büyük Hamam, Plan (2004).

### 3. Definition of Domes

#### *Soyunmalık Dome (S01)*

*Soyunmalık* dome covers the square space with 7.60 x 7.60 m interior dimensions. The depressed arch profiled dome has an interior span of 7.40 m and a height of 3.20 m. Thickness of the dome at the springing level is 45-50 cm and at the top of the dome 35-40 cm. Transition to the dome was provided with lobbed squinches 2.57 m in height. The dome was raised above a circular base 38 cm in interior height while supported by an octagonal exterior drum with 0.90-1.20 m height.





Figure A.64. Seferihisar Büyük Hamam, interior and exterior views of *soyunmalık* dome.

**Construction technique:** *Soyunmalık* dome was constructed with brick and lime mortar as binder. The dome was covered with horasan plaster 1-1.5 cm in interior thickness while 3-5 cm in the exterior. The bricks used in the bond are in the dimensions of 30-31 x 20-21 x 3-3.5 cm and 30-31 x 23-24 x 3-3.5 cm as whole bricks and 20-21 x 14-15 x 3-3.5 cm as half bricks. Both vertical and horizontal flush joints have dimensions between 1.5 and 2.5 cm in interior width, while between 2.5 and 5 cm in the exterior.

**Bond type:** Horizontal and adjacent stacking of the short side faces in parallel rows

**Lighting elements: Lighting lantern on the top**

**Construction technique:** Lighting lantern was formed with an octagonal frame at the top of dome and by raising the frame by means of brick bond and placing glass surfaces with an octagonal form on the frame. The construction techniques could not be determined due to coating dome with cement plaster on the exterior surface later on.

**Volume:** Depressed

**Profile:** Depressed arc

**Center number:** 2

**Distance between two centers:** 27 cm

**Center height:** 3.70 m

**Dome span:** 7.40 m

**Impost height (dome height):** 3.20 m

**Dome thickness:** 0.50 m

**Impost line:** Raised

**Center-impost relation:** Impost line is 50 cm higher than central line

**Impost - wall relation:** Impost is 15-25 cm from wall plane to the interior side

**Dome height / Dome span, Ratio:** 3.20 m / 7.40 m, 0.43

**Dome thickness / Dome span, Ratio:** 0.50 m / 7.40 m, 0.06

**Height of transition element / Dome span, Ratio:** 2.57 m / 7.40 m, 0.34

**Height of exterior supporting element / Dome span, Ratio:** 1.20 m / 7.40 m, 0.16

### ***Ilıklık* central unit dome (I01)**

*Ilıklık* central unit dome covers the square planned middle unit of rectangular planned space having interior dimensions of 1.77 x 7.60 m. The east sub-unit of *ilıklık* is covered with panelled vault while the middle unit and the west sub-unit are covered with domes. The depressed arch profiled dome has an interior span of 1.75 m and a height of 0.80 m. Thickness of the dome at the springing level is 40-45 cm and at the top of the dome 35-40 cm. The dome has a star shaped skylight with 30 cm opening dimension and oculi that are in one horizontal row as equal-size hexagonal shape four oculi on the curved surface of the dome. The oculi are in a form having an opening with 24 cm interior while 14 cm exterior size with narrowing from interior towards exterior and interior surfaces of which were plastered with horasan 1-1.5 cm in thickness while exterior surfaces were plastered with horasan and coated the horasan partially with cement plaster later. Transition to the dome was provided with pendentives 0.70 m in height. The dome was raised above a circular base 27 cm in interior height while settled directly on the walls on the exterior.



Figure A.65. Seferihisar Büyük Hamam, interior and exterior views of *ilıklık* central unit dome.

**Construction technique:** *Ilıklık* central unit dome was constructed with brick and lime mortar as binder. The dome was covered with horasan plaster 1-1.5 cm in interior thickness while 3-5 cm on the exterior. The bricks used in the bond are in the dimensions of 30-31 x 23-24 x 3.5-4 cm as whole bricks and 23-24 x 14-15 x 3.5-4 cm as half bricks. Both vertical and horizontal flush joints have dimensions between 1.5 and 2.5 cm in interior width, while between 2 and 5 cm in the exterior.

**Bond type** Horizontal stacking of the short side faces in places non-parallel rows.

**Lighting elements: Skylight on the top, oculi on the curved surfaces**

**Construction technique:** Skylight and oculi were formed with brick bond. Skylight was formed in a star shape opening on the top of dome, which was arranged by stacking long surfaces of the half-bricks side by side in perpendicular order to the horizontal plane in the dome thickness. Between the half-bricks forming the star shaped opening and the whole bricks stacked radial towards the center of the dome forming the dome thickness were filled with lime mortar including brick pieces and dust. Oculi were formed with brick bond in which the bricks were stacked long surfaces forming hexagonal shaped openings in the dome thickness. The surfaces of the oculi and the skylight were formed with lime mortar coating that included small brick pieces and plastered with horasan. The surface was covered with horasan plaster 1-1.5 cm in interior thickness while 3-5 cm on the exterior.

**Volume:** Slightly depressed semi-circular

**Profile:** Slightly depressed semi-circular arc

**Center number:** 1

**Center height:** 0.88 m

**Dome span:** 1.75 m

**Impost height (dome height):** 0.80 m

**Dome thickness:** 0.45 m

**Impost line:** Raised

**Center-impost relation:** Impost line is 8 cm higher than central line

**Impost - wall relation:** Impost is flush with wall plane

**Dome height / Dome span, Ratio:** 0.80 m / 1.75 m, 0.45

**Dome thickness / Dome span, Ratio:** 0.45 m / 1.75 m, 0.25

**Height of transition element / Dome span, Ratio:** 0.70 m / 1.75 m, 0.40

**Ilıklık West Sub-unit Dome (I02)**

Dome covers the square planned space that was juxtaposed to *ilıklık* central unit from west side with 1.70 x 1.77 m interior dimensions. The depressed arch profiled dome has interior

span of 1.35 m and a dome height of 0.60 m. Thickness of the dome at the springing level is 40-45 cm and at the top of the dome 35-40 cm. The dome has a star shape skylight with 30 cm opening dimension and oculi that are in one horizontal row placed as equal-size hexagonal shape eight oculi on the curved surface of the dome. The oculi are in a form having an opening with 24 cm interior while 14 cm exterior size with narrowing from interior towards exterior. The interior surface was plastered with horasan 1-1.5 cm in thickness while exterior surface was plastered with horasan and coated the horasan with cement plaster later. Transition to the dome was provided with squinches 0.80 m in height. The dome was raised above a hexagonal base 15 cm in interior height while settled directly on the walls on the exterior.



Figure A.66. Seferihisar Büyük Hamam, interior and exterior views of *İllıklık* west sub-unit dome.

**Construction technique:** *İllıklık* west sub-unit dome was constructed with brick and lime mortar as binder. The dome was covered with horasan plaster 1-1.5 cm in interior thickness while 3-5 cm in the exterior. The bricks used in the bond are in the dimensions of 30-31 x 23-24 x 3.5-4 cm as whole bricks and 23-24 x 14-15 x 3-3.5 cm as half bricks. Both vertical and horizontal flush joints have dimensions between 1.5 and 2.5 cm in interior width, while between 2 and 5 cm on the exterior.

**Bond type** Horizontal stacking of the short side faces in places non-parallel rows.

**Lighting elements: Skylight on the top, oculi on the curved surfaces**

**Construction technique:** Skylight and oculi were formed with brick bond as in the dome of *İllıklık* central unit. They have the same construction characteristics. However, on the dome of *İllıklık* central unit the oculi were arranged one horizontal row as four oculi while on the *İllıklık* west sub-unit dome eight oculi.

**Volume:** Depressed

**Profile:** Depressed arc

**Center number:** 1

**Center height:** 0.68 m

**Dome span:** 1.35 m

**Impost height (dome height):** 0.60 m

**Dome thickness:** 0.45 m

**Impost line:** Raised

**Center-impost relation:** Impost line is 8-10 cm higher than central line

**Impost - wall relation:** Impost is 18-20 cm from wall plane to the interior side

**Dome height / Dome span, Ratio:** 0.60 m / 1.35 m, 0.44

**Dome thickness / Dome span, Ratio:** 0.45 m / 1.35 m, 0.33

**Height of transition element / Dome span, Ratio:** 0.80 m / 1.35 m, 0.59

### ***Sıcaklık* Main Space, the Central Unit Dome (SA01)**

The rectangular planned *sıcaklık* main space, which has interior dimensions of 1.77 x 7.60 m, were covered with panelled vaults in the east and west sub-units and with dome in the central unit. *Sıcaklık* central unit dome covers the square planned middle unit with the interior dimensions of 3.10 x 3.20 m. The depressed arch profiled central unit dome has an interior span of 2.95 m and a height of 1.10 m. Thickness of the dome at the springing level is 40-45 cm and at the top of the dome 35-40 cm. The dome has a lighting cupola, on which star shaped oculi were placed, with a 60 cm opening formed in circular frame at the base and oculi that are in two horizontal rows with equal-size star shape and twelve oculi in each row on the curved surface of the dome. The oculi are in a form having an opening with 24 cm interior while 14 cm exterior size with narrowing from interior towards exterior. The interior surface was plastered with horasan 1-1.5 cm in thickness while exterior surface was plastered with horasan and coated the horasan partially with cement plaster later. Transition to the dome was provided with pendentives 0.95 m in height. The dome was raised above a circular base 26 cm in interior height while supported by an octagonal exterior drum with 25-65 cm in height.



Figure A.67. Seferihisar Büyük Hamam, interior and exterior views of *sıcaklık* main space dome.

**Construction technique:** *Sıcaklık* main space, the central unit dome was constructed with brick and lime mortar as binder. The dome was covered with horasan plaster 1-1.5 cm in interior thickness while 4-5 cm in the exterior, but the horasan was partially coated with cement plaster later on. The bricks used in the bond are in the dimensions of 30-31 x 23-24 x 3-3.5 cm as whole bricks and 23-24 x 14-15 x 3-3.5 cm as half bricks. Both vertical and horizontal flush joints have dimensions between 1.5 and 2.5 cm in interior width, while between 3 and 5 cm on the exterior.

**Bond type** Horizontal stacking of the short side faces in places non-parallel rows.

**Lighting elements: Lighting cupola on the top, oculi on the curved surfaces**

**Construction technique:** Lighting cupola and oculi were formed with brick bond. Lighting cupola was formed with a circular frame on the top of dome, which was arranged by stacking long surfaces of the half-bricks side by side in perpendicular order to the horizontal plane in the dome thickness. Between the half-bricks forming the circular frame and the whole bricks stacked radial towards the center of the dome forming the dome thickness were filled with lime mortar including brick pieces and dust. The curved upper side of the lighting cupola was formed by stacking short surfaces of half-brick radial towards the center of the cupola forming the cupola thickness. The star shaped oculi, in smaller size than the oculi placed on the surface of

dome, were arranged on the surface of lighting cupola. The surface was covered with horasan plaster 1-1.5 cm in interior thickness while 3-5 cm on the exterior. Oculi were formed with brick bond in which the bricks were stacked long surfaces forming star shaped openings in the dome thickness. The surfaces of the oculi and lighting cupola were formed with lime mortar coating including in small brick pieces and plastered with horasan.

**Volume:** Depressed

**Profile:** Depressed arc

**Center number:** 2

**Distance between two centers:** 15 cm

**Center height:** 1.48 m

**Dome span:** 2.95 m

**Impost height (dome height):** 1.10 m

**Dome thickness:** 0.45 m

**Impost line:** Raised

**Center-impost relation:** Impost line is 38 cm higher than central line

**Impost - wall relation:** Impost is 8-13 cm from wall plane to the interior side

**Dome height / Dome span, Ratio:** 1.10 m / 2.95 m, 0.37

**Dome thickness / Dome span, Ratio:** 0.45 m / 2.95 m, 0.15

**Height of transition element / Dome span, Ratio:** 0.95 m / 2.95 m, 0.32

**Height of exterior supporting element / Dome span, Ratio:** 0.65 m / 2.95 m, 0.22

#### **Southeast *Halvet* Dome (H01)**

Dome covers the square planned space that was juxtaposed to *sıcaklık* main space from east side with 3.10 x 3.10 m interior dimensions. The depressed arch profiled dome has interior span of 2.95 m and a dome height of 1.20 m. Thickness of the dome at the springing level is 40-45 cm and at the top of the dome 37-40 cm. The dome has a lighting cupola, on which star shaped oculi were placed, with a 60 cm opening formed in circular frame at the base and oculi that are in two horizontal rows with equal-size star shape eight oculi in each row on the curved surface of the dome. The oculi are in a form having an opening with 23-24 cm interior while 13 cm exterior sizes with narrowing from interior towards exterior. The interior surface was plastered with horasan 1-1.5 cm in thickness. Transition to the dome was provided with pendentives 1.04 m in height. The dome was raised above a circular base 25 cm in interior height while settled directly on the walls on the exterior.

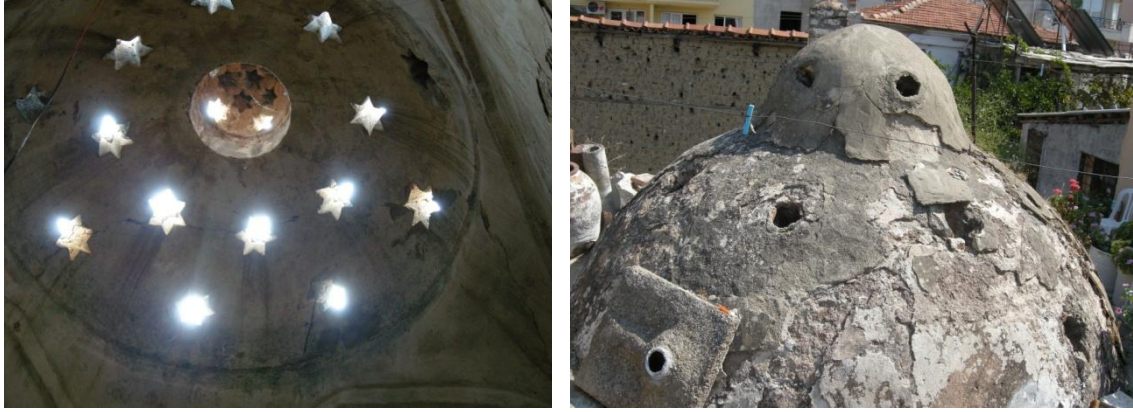

Figure A.68. Seferihisar Büyük Hamam, interior and exterior views of southeast *halvet* dome.

**Construction technique:** Southeast *halvet* dome was constructed with brick and lime mortar as binder. The dome was covered with horasan plaster 1-1.5 cm in interior thickness while 6-8 cm in the exterior, but the horasan was partially coated with cement plaster by later interventions. The bricks used in the bond are in the dimensions of 27-28 x 17-18 x 3-3.5 cm as whole bricks and 23-24 x 14-15 x 3-3.5 cm as half bricks. Both vertical and horizontal flush joints have dimensions between 1.5 and 2.5 cm in interior width, while between 3 and 4 cm on the exterior.

**Bond type** Horizontal stacking of the short side faces in places non-parallel rows.

**Lighting elements: Lighting cupola on the top, oculi on the curved surfaces**

**Construction technique:** Lighting cupola and oculi were formed with brick bond. Lighting cupola was formed with a circular frame on the top of dome, which was arranged by stacking long surfaces of the half-bricks side by side in perpendicular order to the horizontal plane in the dome thickness. Between the half-bricks placed in perpendicular order to the horizontal plane and formed the circular frame and the whole bricks stacked radial towards the center of the dome forming the dome thickness were filled with lime mortar including brick pieces and dust. The curved upper side of the lighting cupola was formed by stacking short surfaces of half-brick radial towards the center of the cupola forming the cupola thickness. The star shaped oculi, in smaller size than the oculi placed on the surface of dome, were arranged on the surface of lighting cupola. The surface was covered with horasan plaster 1-1.5 cm in interior thickness while 6-8 cm on the exterior. Oculi were formed with brick bond in which the bricks were stacked long surfaces forming star shaped openings in the dome thickness. The surfaces of the oculi and lighting cupola were formed with lime mortar coating including small brick pieces and plastered with horasan.

**Volume:** Depressed

**Profile:** Depressed arc



**Center number:** 2

**Distance between two centers:** 20 cm

**Center height:** 1.48 m

**Dome span:** 2.95 m

**Impost height (dome height):** 1.20 m

**Dome thickness:** 0.45 m

**Impost line:** Raised

**Center-impost relation:** Impost line is 28 cm higher than central line

**Impost - wall relation:** Impost is 8-10 cm from wall plane to the interior side

**Dome height / Dome span, Ratio:** 1.20 m / 2.95 m, 0.40

**Dome thickness / Dome span, Ratio:** 0.45 m / 2.95 m, 0.15

**Height of transition element / Dome span, Ratio:** 1.04 m / 2.95 m, 0.35

### **Southwest *Halvet* Dome (H02)**

Dome covers the square planned space that was juxtaposed to *sıcaklık* main space from west side with 3.10 x 3.10 m interior dimensions. The depressed arch profiled dome has interior span of 2.95 m and a dome height of 1.15 m. Thickness of the dome at the springing level is 40-45 cm and at the top of the dome 37-40 cm. The dome has a star shape skylight with 30 cm opening dimension and oculi that are in two horizontal rows placed as equal-size hexagonal shape eight oculi in each row on the curved surface of the dome. The oculi are in a form having an opening with 24 cm interior while 14 cm exterior size with narrowing from interior towards exterior. The interior surface was plastered with horasan 1-1.5 cm in thickness. Transition to the dome was provided with pendentives 0.91 m in height. The dome was raised above a circular base 25 cm in interior height while settled directly on the walls on the exterior.



Figure A.69. Seferihisar Büyük Hamam, interior and exterior views of southwest *halvet* dome.

**Construction technique:** Southwest *halvet* dome was constructed with brick and lime mortar as binder. The dome was covered with horasan plaster 1-1.5 cm in interior thickness while 6-8

cm in the exterior, but the horasan was partially coated with cement plaster by later interventions. The bricks used in the bond are in the dimensions of 27-28 x 17-18 x 3-3.5 cm as whole bricks and 23-24 x 14-15 x 3-3.5 cm as half bricks. Both vertical and horizontal flush joints have dimensions between 1.5 and 2.5 cm in interior width, while between 3 and 4 cm on the exterior.

**Bond type** Horizontal stacking of the short side faces in places non-parallel rows.

**Lighting elements: Skylight on the top, oculi on the curved surfaces**

**Construction technique:** Skylight and oculi were formed with brick bond as in the *ıkkık* domes. They have the same construction characteristics.

**Volume:** Depressed

**Profile:** Depressed arc

**Center number:** 2

**Distance between two centers:** 16 cm

**Center height:** 1.48 m

**Dome span:** 2.95 m

**Impost height (dome height):** 1.15 m

**Dome thickness:** 0.45 m

**Impost line:** Raised

**Center-impost relation:** Impost line is 33 cm higher than central line

**Impost - wall relation:** Impost is 12-16 cm from wall plane to the interior side

**Dome height / Dome span, Ratio:** 1.15 m / 2.95 m, 0.39

**Dome thickness / Dome span, Ratio:** 0.45 m / 2.95 m, 0.15

**Height of transition element / Dome span, Ratio:** 0.91 m / 2.95 m, 0.30

**Catalogue No: 12 – Construction Name: Seferihisar Küçük Hamam**

**1. Construction Date**

The *hamam* has no inscription. It can be dated back to the 16<sup>th</sup> century taking into consideration the enlargement of the square planned domed *ılıklik* central unit with barrel vaulted two side sections and use of timber roof as the superstructure of *soyunmalık* (Önge 1995; Reyhan 2004).



Figure A.70. Seferihisar Küçük Hamam, a general view of superstructure (2008).

**2. Plan Characteristics**

The *hamam* is composed in a plan organization from south to north a rectangular planned *ılıklik* / *sıcaklık* main space and two corner *halvets*. In addition, in the north part there is a rectangular planned water reservoir. The square planned central unit of *ılıklik* / *sıcaklık* main space and corner *halvets* were covered with domes while the rectangular planned *ılıklik* / *sıcaklık* main space side units and water reservoir were covered with barrel vaults. The *hamam* can be evaluated in the plan type of elongated *sıcaklık* with domed central unit and two *halvets* (Eyice 1960).

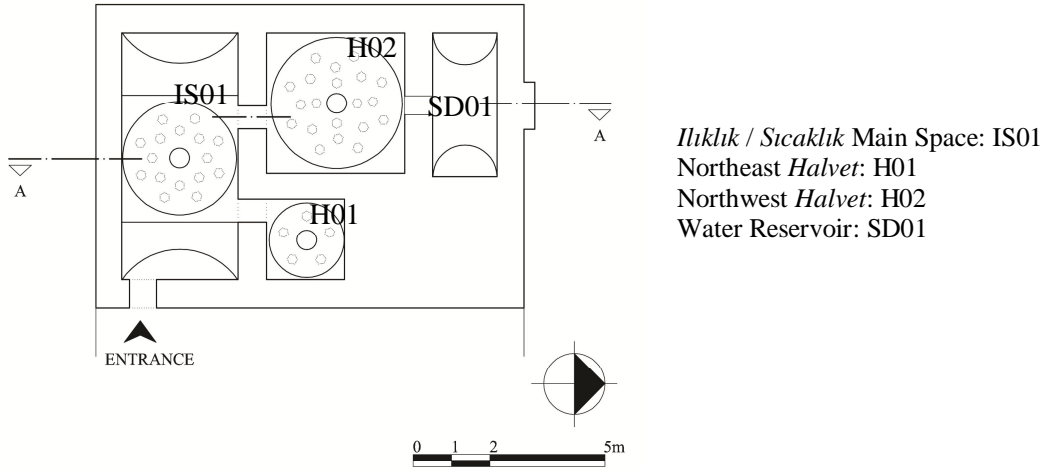

Figure A.71. Seferihisar Küçük Hamam, Plan (2004).

### 3. Definition of Domes

#### *Ilıklık / Sıcaklık* Main Space Dome (IS01)

The rectangular planned *ilıklık / sıcaklık* main space, which has interior dimensions of 2.97 x 6.30 m, was covered with barrel vaults in the east and west sub-units and with dome in the central unit. *Ilıklık / sıcaklık* main space dome covers the square planned middle unit with interior dimensions of 2.97 x 3.05 m. The semi-circular arch profiled central unit dome has an interior span of 2.90 m and a height of 1.50 m. Thickness of the dome at the springing level is 40-45 cm and at the top of the dome 35-40 cm. The dome has lighting cupola, on the top of which hexagonal shaped oculus were placed, with a 60 cm opening formed in circular frame at the base and oculi that are in two horizontal rows with equal-size hexagonal shape eight oculi in each row on the curved surface of the dome. The oculi are in a form having an opening with 23-24 cm interior while 13-14 cm exterior size with narrowing from interior towards exterior. The interior surface was plastered with horasan 1-1.5 cm in thickness. Transition to the dome was provided with plain triangles 1.35 m in height. The dome was raised above an octagonal base 26 cm in interior height while supported by an octagonal exterior drum with 60 cm height.



Figure A.72. Seferihisar Küçük Hamam, interior and exterior views of *ilıklık / sıcaklık* main space dome.

**Construction technique:** *Ilıklık / sıcaklık* main space dome was constructed with brick and lime mortar as binder. The dome was covered with horasan plaster 1-1.5 cm in interior thickness while 3-5 cm on the exterior. The bricks used in the bond are in the dimensions of 30-31 x 23-24 x 3-3.5 cm as whole bricks and 23-24 x 14-15 x 3-3.5 cm as half bricks. Both vertical and horizontal flush joints have dimensions between 1.5 and 2.5 cm in interior width, while between 4 and 6 cm on the exterior.

**Bond type:** Horizontal stacking of the short side faces in places non-parallel rows.

**Lighting elements: Lighting cupola on the top, oculi on the curved surfaces**

**Construction technique:** Lighting cupola on the top and oculi were formed with brick bond. Lighting cupola on the top was formed with a circular frame on the top of dome with 60 cm span, which was arranged by stacking long surfaces of the half-bricks side by side in perpendicular order to the horizontal plane in the dome thickness. Between the half-bricks forming the circular frame and the whole bricks stacked radial towards the center of the dome forming the dome thickness were filled with lime mortar including brick pieces and dust. Upper side of the cupola was formed with a hemispherical-shaped terracotta lid 1.5 cm in thickness and brick bond arranged with half-bricks 15 cm in thickness overlapped radial towards the cupola center over the terracotta material. The surface was covered with horasan plaster 1-1.5 cm in interior thickness while 3-5 cm on the exterior. In addition, a circular shaped oculus on the top of the lighting cupola was arranged.

Oculi were formed with brick bond in which the bricks were stacked long surfaces forming hexagonal openings in the dome thickness. Oculi, narrowed from interior to exterior, have 23-24 cm interior span while 13-14 cm exterior. The hexagonal forms of oculi were formed with lime mortar including brick pieces and dust. Over the lime mortar forming, the exterior surfaces of the oculi were plastered with horasan 1-1.5 cm in thickness.

**Volume:** Semi-circular

**Profile:** Semi-circular arc

**Center number:** 1

**Center height:** 1.45 m

**Dome span:** 2.90 m

**Impost height (dome height):** 1.50 m

**Dome thickness:** 0.45 m

**Impost line:** Raised

**Center-impost relation:** Impost line is 5 cm lower than central line

**Impost - wall relation:** Impost is 5-6 cm from wall plane to the interior side

**Dome height / Dome span, Ratio:** 1.50 m / 2.90 m, 0.51

**Dome thickness / Dome span, Ratio:** 0.45 m / 2.90 m, 0.15

**Height of transition element / Dome span, Ratio:** 1.35 m / 2.90 m, 0.46

**Height of exterior supporting element / Dome span, Ratio:** 0.60 m / 2.90 m, 0.20

#### **Northeast *halvet* dome (H01)**

Dome covers the square planned space that was juxtaposed to *ılıklik / sıcaklık* main space from northeast side with 1.89 x 1.90 m interior dimensions. The slightly depressed arch profiled dome has interior span of 1.90 m and a dome height of 0.90 m. Thickness of the dome at the springing level is 40-45 cm and at the top of the dome 35-40 cm. The dome has a lighting cupola, on the top of which circular shaped oculi were placed, with a 35 cm opening formed in circular frame at the base and oculi that are in one horizontal row with equal-size hexagonal shape five oculi in the row on the curved surface of the dome. The oculi are in a form having an opening with 17-18 cm interior while 13-14 cm exterior size with narrowing from interior towards exterior. The interior surface was plastered with horasan 1-1.5 cm in thickness. Transition to the dome was provided with pendentives 1.02 m in height. The dome was raised above a circular base 25 cm in interior height while settled directly on the walls on the exterior.



Figure A.73. Seferihisar Küçük Hamam, interior and exterior views of northeast *halvet* dome.

**Construction technique:** Northeast *halvet* dome was constructed with brick and lime mortar as binder. The dome was covered with horasan plaster 1-1.5 cm in interior thickness while 6-8 cm on the exterior. The bricks used in the bond are in the dimensions of 27-28 x 17-18 x 3-3.5 cm as whole bricks and 23-24 x 14-15 x 3-3.5 cm as half bricks. Both vertical and horizontal flush joints have dimensions between 1.5 and 2.5 cm in interior width, while between 3 and 4 cm on the exterior.

**Bond type:** Horizontal stacking of the short side faces in places non-parallel rows.

**Lighting elements: Lighting cupola on the top, oculi on the curved surfaces**

**Construction technique:** Lighting cupola on the top and oculi were formed with brick bond. Lighting cupola on the top was formed with a circular frame on the top of the dome with 60 cm span, which was arranged with stacking long surfaces of the half-bricks side by side in perpendicular order to the horizontal plane in the dome thickness. Between the half-bricks forming the circular frame and the whole bricks stacked radial towards the center of the dome forming the dome thickness were filled with lime mortar including brick pieces and dust. Upper side of the cupola was formed with a hemispherical-shape terracotta lid 1.5 cm in thickness and brick bond arranged by half-bricks 15 cm in thickness overlapped radial towards the cupola center over the terracotta material. The surface was covered with horasan plaster 1-1.5 cm in interior thickness while 6-8 cm on the exterior. In addition, a circular shaped oculus on the top of the lighting cupola was arranged.

Oculi were formed with brick bond in which the bricks were stacked long surfaces forming hexagonal openings in the dome thickness. Oculi, narrowed from interior to exterior, have 17-18 cm interior span while 13-14 cm exterior. The hexagonal forms of oculi were formed with lime mortar including brick pieces and dust. Over the lime mortar forming, the exterior surfaces of the oculi were plastered with horasan 1-1.5 cm in thickness.

**Volume:** Slightly depressed semi-circular

**Profile:** Slightly depressed semi-circular arc

**Center number:** 1

**Center height:** 0.95 m

**Dome span:** 1.90 m

**Impost height (dome height):** 0.90 m

**Dome thickness:** 0.45 m

**Impost line:** Raised

**Center-impost relation:** Impost line is 5 cm higher than central line

**Impost - wall relation:** Impost is flush with wall plane

**Dome height / Dome span, Ratio:** 0.90 m / 1.90 m, 0.47

**Dome thickness / Dome span, Ratio:** 0.45 m / 1.90 m, 0.23

**Height of transition element / Dome span, Ratio:** 1.02 m / 1.90 m, 0.53

#### **Northwest *halvet* dome (H01)**

Dome covers the square planned space that was juxtaposed to *ılıklik / sıcaklık* main space from northwest side with 3.85 x 3.86 m interior dimensions. The slightly depressed semi circular arch profiled dome has interior span of 3.79 m and a dome height of 1.80 m. Thickness of the dome at the springing level is 40-45 cm and at the top of the dome 35-40 cm. The dome has a lighting cupola, on the top of which circular shaped oculus were placed, with a 55 cm opening formed in circular frame at the base and oculi that are in three horizontal rows with equal-size hexagonal shape four oculi in the interior row while eight oculi in two exterior rows on the curved surface of the dome. The oculi are in a form having an opening with 17-18 cm interior while 13-14 cm exterior size with narrowing from interior towards exterior. The interior surface was plastered with horasan 1-1.5 cm in thickness. Transition to the dome was provided with pendentives 1.30 m in height. The dome was raised above a circular base 25 cm in interior height while supported by two octagonal exterior drums successively, below with 90-100 cm and above with 60-65 cm height.





Figure A.74. Seferihisar Küçük Hamam, interior and exterior views of northwest *halvet* dome.

**Construction technique:** Northwest *halvet* dome was constructed with brick and lime mortar as binder. The dome was covered with horasan plaster 1-1.5 cm in interior thickness while 6-8 cm on the exterior. The bricks used in the bond are in the dimensions of 27-28 x 17-18 x 3-3.5 cm as whole bricks and 23-24 x 14-15 x 3-3.5 cm as half bricks. Both vertical and horizontal flush joints have dimensions between 1.5 and 2.5 cm in interior width, while between 3 and 4 cm on the exterior.

**Bond type:** Horizontal stacking of the short side faces in places non-parallel rows.

**Lighting elements: Lighting cupola on the top, oculi on the curved surfaces**

**Construction technique:** Lighting cupola on the top and oculi were formed with brick bond. Lighting cupola on the top was formed with a circular frame on the top of the dome with 60 cm span, which was arranged by stacking long surfaces of the half-bricks side by side in perpendicular order to the horizontal plane in the dome thickness. Between the half-bricks forming the circular frame and the whole bricks stacked radial towards the center of the dome forming the dome thickness were filled with lime mortar including brick pieces and dust. Upper side of the cupola was formed with a hemispherical-shape terracotta lid 1.5 cm in thickness and brick bond arranged by half-bricks 15 cm in thickness overlapped radial towards the cupola center over the terracotta material. The surface was covered with horasan plaster 1-1.5 cm in interior thickness while 6-8 cm on the exterior. In addition, a circular shaped oculus on the top of the lighting cupola was arranged.

Oculi were formed with brick bond in which the bricks were stacked long surfaces forming hexagonal openings in the dome thickness. Oculi, narrowed from interior to exterior, have 17-18 cm interior span while 13-14 cm exterior. The hexagonal forms of oculi were formed with lime mortar including brick pieces and dust. Over the lime mortar forming, the exterior surfaces of the oculi were plastered with horasan 1-1.5 cm in thickness.

**Volume:** Slightly depressed semi-circular

**Profile:** Slightly depressed semi-circular arc

**Center number:** 1

**Center height:** 1.90 m

**Dome span:** 3.79 m

**Impost height (dome height):** 1.80 m

**Dome thickness:** 0.45 m

**Impost line:** Raised

**Center - impost relation:** Impost line is 10 cm higher than central line

**Impost - wall relation:** Impost is 3-5 cm from wall plane to the interior side

**Dome height / Dome span, Ratio:** 1.80 m / 3.79 m, 0.47

**Dome thickness / Dome span, Ratio:** 0.45 m / 3.79 m, 0.11

**Height of transition element / Dome span, Ratio:** 1.30 m / 3.79 m, 0.34

**Height of exterior supporting element / Dome span, Ratio:** 1.65 m / 3.79 m, 0.43

## 1. Construction Date

The *hamam* has no inscription. It can be dated back to the 16<sup>th</sup> century taking into consideration the enlargement of the square planned and domed *ılıklik* central unit with barrel vaulted two side sections, use of timber roof as the superstructure of *soyunmalık*, and the windows on the walls of the *soyunmalık* space<sup>1</sup> (Önge 1995; Reyhan 2004).



Figure A.75. Sığacık Kaleiçi Hamam, a general view of superstructure (2004).

## 2. Plan Characteristics

The *hamam* is composed in a plan organization from northwest to southeast *soyunmalık* that is lost completely today, a rectangular planned *ılıklik* / *sıcaklık* main space and two corner *halvets* connected to each other. In addition, in the southeast part there is a rectangular planned water reservoir. The square planned central unit of *ılıklik* / *sıcaklık* main space and corner *halvets* were covered with domes while the rectangular planned *ılıklik* / *sıcaklık* main space side units and water reservoir were covered with barrel vaults. The *hamam* can be evaluated in the plan type of elongated *sıcaklık* with domed central unit and two *halvets* (Eyice 1960). However, the corner *halvets* were connected to each other in which the entrance is provided from *ılıklik* / *sıcaklık* main space to the east *halvet* and then to the west *halvet*.

---

<sup>1</sup> The walls and timber roof of *soyunmalık* are collapsed today due to an earthquake that happened in Seferihisar in 2003.

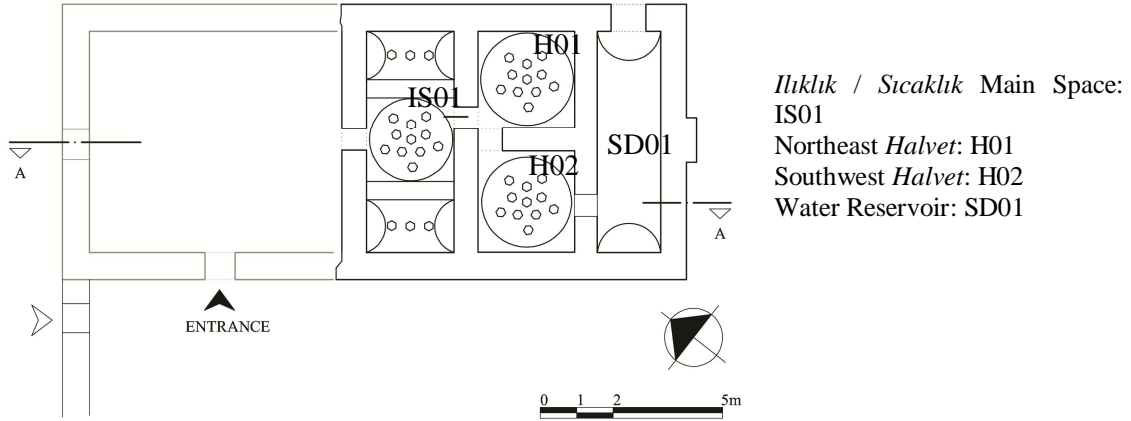

Figure A.76. Sığacık Kaleiçi Hamam, Plan (2004).

### 3. Definition of Domes

#### *Ilıklık / Sıcaklık* Main Space Dome (IS01)

The rectangular planned *ilıklık / sıcaklık* main space, which has interior dimensions of 2.25 x 5.12 m, was covered with barrel vaults in the east and west sub-units and with dome in the central unit. *Ilıklık / sıcaklık* main space dome covers the square planned middle unit with interior dimensions of 2.25 x 2.30 m. The depressed arch profiled central unit dome has an interior span of 2.20 m and a height of 0.95 m. Thickness of the dome at the springing level is 40-45 cm and at the top of the dome 35-40 cm. The dome has a hexagonal formed skylight with a 20 cm opening dimension on the top and oculi that are in two horizontal rows with equal-size hexagonal shape five oculi in each row on the curved surface of the dome. The oculi are in a form having an opening with 17-18 cm interior while 13-14 cm exterior size with narrowing from interior towards exterior. The interior surface was plastered with horasan 1-1.5 cm in thickness. Transition to the dome was provided with pendentives 1.32 m in height. The dome was raised above an octagonal base 45 cm in interior height while settled directly on the walls on the exterior.



Figure A.77. Sığacık Kaleiçi Hamam, interior and exterior views of *ılıklık / sıcaklık* main space dome.

**Construction technique:** *Ilıklık / sıcaklık* main space dome was constructed with brick and lime mortar as binder. The dome was covered with horasan plaster 1-1.5 cm in interior thickness while 3-5 cm on the exterior. The bricks used in the bond are in the dimensions of 23-24 x 16-17 x 6-6.5 cm as whole bricks and 23-24 x 10-11 x 6-6.5 cm as half bricks. Both vertical and horizontal flush joints have dimensions between 1.5 and 2.5 cm in interior width, while between 4 and 6 cm on the exterior.

**Bond type:** Horizontal stacking of the short side faces in places non-parallel rows.

**Lighting elements: Skylight on the top, oculi on the curved surfaces**

**Construction technique:** Skylight and oculi were formed with brick bond. Skylight was formed in a hexagonal shape opening on the top of dome, which was arranged by stacking long surfaces of the half-bricks side by side in perpendicular order to the horizontal plane in the dome thickness. Between the half-bricks forming the hexagonal shaped opening and whole bricks stacked radial towards the center of the dome forming the dome thickness were filled with lime mortar including brick pieces and dust. Oculi were formed with brick bond in which the bricks were stacked long surfaces forming hexagonal shaped openings in the dome thickness. The surfaces of the oculi and skylight were formed with lime mortar coating that included small brick pieces and plastered with horasan. The surface was covered with horasan plaster 1-1.5 cm in interior thickness while 3-5 cm on the exterior.

**Volume:** Depressed

**Profile:** Depressed arc

**Center number:** 1

**Center height:** 1.10 m

**Dome span:** 2.20 m

**Impost height (dome height):** 0.95 m

**Dome thickness:** 0.45 m

**Impost line:** Raised

**Center - impost relation:** Impost line is 15 cm higher than central line

**Impost - wall relation:** Impost is 8-10 cm from wall plane to the interior side

**Dome height / Dome span, Ratio:** 0.95 m / 2.20 m, 0.43

**Dome thickness / Dome span, Ratio:** 0.45 m / 2.20 m, 0.20

**Height of transition element / Dome span, Ratio:** 1.32 m / 2.20 m, 0.60

### Northeast Halvet Dome (H01)

Dome covers the square planned space that was juxtaposed to *ılıklik / sıcaklık* main space from northeast side with 2.30 x 2.35 m interior dimensions. The depressed arch profiled dome has interior span of 2.16 m and a dome height of 0.65 m. Thickness of the dome at the springing level is 40-45 cm and at the top of the dome 35-40 cm. The dome has a hexagonal formed skylight with a 20 cm opening dimension on the top and oculi that are in two horizontal rows with equal-size hexagonal shape five oculi in each row on the curved surface of the dome. The oculi are in a form having an opening with 17-18 cm interior while 13-14 cm exterior size with narrowing from interior towards exterior. The interior surface was plastered with horasan 1-1.5 cm in thickness. Transition to the dome was provided with pendentives 1.20 m in height. The dome was raised above a circular base 25 cm in interior height while settled directly on the walls on the exterior.



Figure A.78. Sığacık Kaleiçi Hamam, interior and exterior views of northeast *halvet* dome.

**Construction technique:** Northeast *halvet* dome was constructed with brick and lime mortar as binder. The dome was covered with horasan plaster 1-1.5 cm in interior thickness while 3-5 cm on the exterior. The bricks used in the bond are in the dimensions of 23-24 x 17-18 x 6-6.5 cm as whole bricks and 23-24 x 11-12 x 6-6.5 cm as half bricks. Both vertical and horizontal flush joints have dimensions between 1.5 and 2.5 cm in interior width, while between 3 and 4 cm on the exterior.

**Bond type:** Horizontal stacking of the short side faces in places non-parallel rows.

**Lighting elements:** Skylight on the top, oculi on the curved surfaces

**Construction technique:** Skylight and oculi were formed with brick bond. The skylight was formed in a hexagonal shape opening on the top of dome, which was arranged by stacking long surfaces of the half-bricks side by side in perpendicular order to the horizontal plane in the dome thickness. Between the half-bricks forming the hexagonal shaped opening and whole bricks stacked radial towards the center of the dome forming the dome thickness were filled with lime mortar including brick pieces and dust. Oculi were formed with brick bond in which the bricks were stacked long surfaces forming hexagonal shaped openings in the dome thickness. The surfaces of the oculi and skylight were formed with lime mortar coating that included small brick pieces and plastered with horasan. The surface was covered with horasan plaster 1-1.5 cm in interior thickness while 3-5 cm on the exterior.

**Volume:** Depressed

**Profile:** Depressed arc

**Center number:** 1

**Center height:** 1.08 m

**Dome span:** 2.23 m

**Impost height (dome height):** 0.65 m

**Dome thickness:** 0.45 m

**Impost line:** Raised

**Center - impost relation:** Impost line is 43 cm higher than central line

**Impost - wall relation:** Impost is 16-20 cm from wall plane to the interior side

**Dome height / Dome span, Ratio:** 0.65 m / 2.16 m, 0.30

**Dome thickness / Dome span, Ratio:** 0.45 m / 2.16 m, 0.20

**Height of transition element / Dome span, Ratio:** 1.20 m / 2.16 m, 0.55

### **Southwest Halvet Dome (H02)**

Dome covers the square planned space that was juxtaposed to *ılıklik / sıcaklık* main space from southwest side with 2.30 x 2.35 m interior dimensions. The depressed arch profiled dome has interior span of 2.23 m and a dome height of 0.70 m. Thickness of the dome at the springing level is 40-45 cm and at the top of the dome 35-40 cm. The dome has a hexagonal formed skylight with a 20 cm opening dimension on the top and oculi that are in two horizontal rows with equal-size hexagonal shape five oculi in each row on the curved surface of the dome. The oculi are in a form having an opening with 17-18 cm interior while 13-14 cm exterior size with narrowing from interior towards exterior. The interior surface was plastered with horasan

1-1.5 cm in thickness. Transition to the dome was provided with pendentives 1.18 m in height. The dome was raised above a circular base 25 cm in interior height while settled directly on the walls on the exterior.



Figure A.79. Sığacık Kaleiçi Hamam, interior and exterior views of southwest *halvet* dome.

**Construction technique:** Southwest *halvet* dome was constructed with brick and lime mortar as binder. The dome was covered with horasan plaster 1-1.5 cm in interior thickness while 6-8 cm on the exterior. The bricks used in the bond are in the dimensions of 23-24 x 17-18 x 6-6.5 cm as whole bricks and 23-24 x 11-12 x 6-6.5 cm as half bricks. Both vertical and horizontal flush joints have dimensions between 1.5 and 2.5 cm in interior width, while between 3 and 4 cm on the exterior.

**Bond type:** Horizontal stacking of the short side faces in places non-parallel rows.

**Lighting elements: Skylight on the top, oculi on the curved surfaces**

**Construction technique:** Skylight and oculi were formed with brick bond. The skylight was formed in a hexagonal shape opening on the top of the dome, which was arranged by stacking long surfaces of the half-bricks side by side in perpendicular order to the horizontal plane in the dome thickness. Between the half-bricks forming the hexagonal shaped opening and whole bricks stacked radial towards the center of the dome forming the dome thickness were filled with lime mortar including brick pieces and dust. Oculi were formed with brick bond in which the bricks were stacked long surfaces forming hexagonal shaped openings in the dome thickness. The surfaces of the oculi and skylight were formed with lime mortar coating that included small brick pieces and plastered with horasan. The surface was covered with horasan plaster 1-1.5 cm in interior thickness while 6-8 cm on the exterior.

**Volume:** Depressed

**Profile:** Depressed arc

**Center number:** 1



**Center height:** 1.12 m

**Dome span:** 2.23 m

**Impost height (dome height):** 0.70 m

**Dome thickness:** 0.45 m

**Impost line:** Raised

**Center - impost relation:** Impost line is 42 cm higher than central line

**Impost - wall relation:** Impost is 18-22 cm from wall plane to the interior side

**Dome height / Dome span, Ratio:** 0.70 m / 2.23 m, 0.31

**Dome thickness / Dome span, Ratio:** 0.45 m / 2.23 m, 0.20

**Height of transition element / Dome span, Ratio:** 1.18 m / 2.23 m, 0.53

### **1. Construction Date**

The *hamam* has no inscription. It can be dated back to the 15<sup>th</sup> century taking into consideration the enlargement of the square planned domed *ılıklik* central unit with barrel vaulted one side section in the men's section and use of the geometrical, floral and muqarnas decorations on the transition zones to the dome (Akyıldız 1988; Önge 1995; Çakmak 2002; Reyhan 2004).



Figure A.80. Urla Hersekzade Ahmet Paşa Hamamı (Urla Çifte Hamam), a general view of superstructure (2008).

### **2. Plan Characteristics**

The building is a double bath with a men's section and a women's section. The men's section is located in the east part of the bath, while the women's section is located in the west. Domes of the spaces are lost today in the men's section except for partial *ılıklik* dome and north *halvet* dome. Both sections consist of *soyunmalık*, *ılıklik*, *sıcaklık* spaces, and a rectangular planned water reservoir used by both. *Sıcaklık* contains rectangular planned *sıcaklık* main space and square planned two corner *halvets* in the women's section while rectangular planned *sıcaklık* main space and square planned three corner *halvets* in the men's section. The square planned *ılıklik* central units in both the men's section and the women's section, the square planned *ılıklik* sub-unit (*tıraşlık*) in the women's section, the central units of *sıcaklık* main spaces in both sections and all the corner *halvets* were covered with domes while the rectangular

planned side units of *ılıklik* and *sıcaklık* main spaces, and water reservoir with barrel vaults. Both the men's and the women's sections can be evaluated within the plan type of elongated *sıcaklık* with domed central unit and two *halvets* (Eyice 1960), but in the men's section there are three *halvets*.

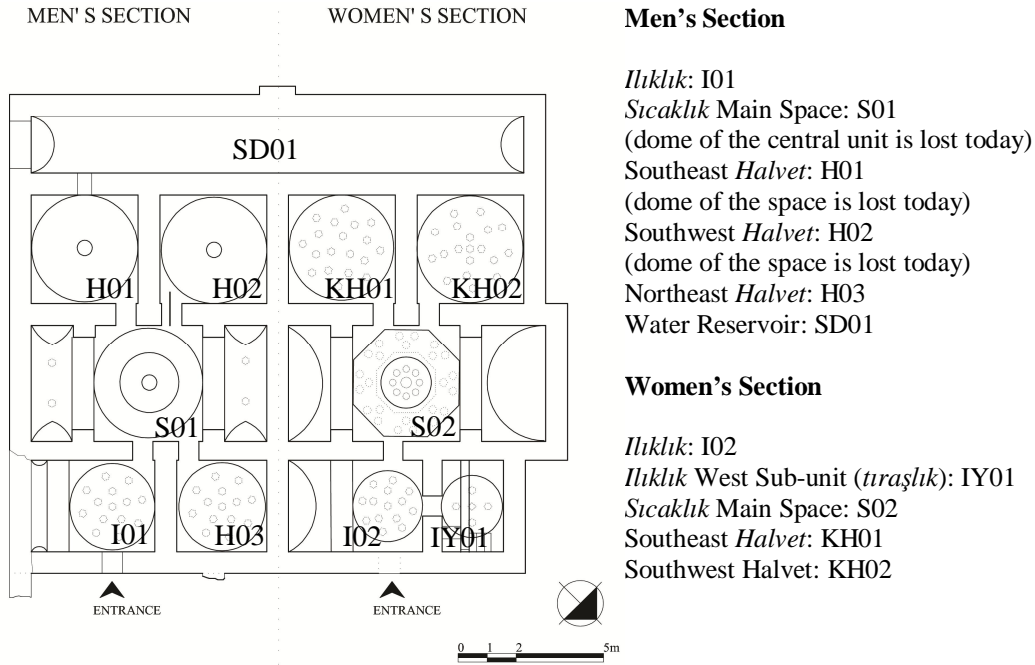

Figure A.81. Urla Hersekzade Ahmet Paşa Hamamı, Plan (2004).

### 3. Definition of Domes

#### The Men's Section, *Ilıklık* Dome (I01)

*Ilıklık* dome covers the square planned central unit of rectangular planned space with the interior dimensions of 3.10 x 4.05 m. The dome was supported by barrel vault at the east. The semi-circular profiled dome has an interior span of 3.00 m and a height of 1.60 m. Thickness of the dome at the springing level is 56-60 cm and at the top of the dome 45-49 cm. The dome, partially collapsed, has equal-size and hexagonal shape oculi in two horizontal rows on the curved surfaces. The oculi are in a form having an opening with 18-19 cm interior while 14 cm exterior sizes with narrowing from interior towards exterior. The interior surface was plastered with horasan 1-1.5 cm in thickness. Transition to the dome was provided with pendentives 1.43 cm in height. The dome was raised above two interior bases successively, below with an octagonal form of 35 cm and above with a circular form of 26 cm in height while settled directly on the walls on the exterior.



Figure A.82. Urla Hersekzade Ahmet Paşa Hamamı, interior and exterior views of *ılıklık* dome in the men's section.

**Construction technique:** *Ilıklık* dome of the men's section was constructed with brick, stone and lime mortar as binder. The dome was covered with horasan plaster 1-1.5 cm in interior thickness while 3-5 cm on the exterior and coated with a thick layer of lime mortar 15-18 cm in thickness including small and large pieces of slate stones, bricks and tiles. The bricks used in the bond are in the dimensions of 30-31 x 23-24 x 3-4 cm as whole bricks and 23-24 x 14-15 x 3-4 cm as half bricks. Dimensions of the slate stones in the bond are the same with the brick dimensions except thickness of the stones are between 5 and 8 cm. Both vertical and horizontal flush joints have dimensions between 1.5 and 2.5 cm in interior width, while between 2 and 5 cm on the exterior.

**Bond type:** Irregular brick / stone bond formed by horizontal stacking of the short side faces of bricks and cut stone in random rows at the springing level while by stacking bricks and cut stone in random rows in perpendicular order to the horizontal plane in the dome thickness on the top of the dome.

**Lighting elements: Oculi on the curved surfaces**

**Construction technique:** Oculi were formed with irregular brick/stone bond in which the bricks and stones were stacked long surfaces forming hexagonal openings in the dome thickness. The hexagonal forms of oculi were formed with lime mortar including brick pieces and dust. Over the lime mortar forming, the exterior surfaces of the oculi were plastered with horasan 1-1.5 cm in thickness.

**Volume:** Semi circular

**Profile:** Semi circular arc

**Center number:** 1

**Center height:** 1.50 m

**Dome span:** 3.00 m

**Impost height (dome height):** 1.60 m

**Dome thickness:** 0.60 m

**Impost line:** Lowered

**Center - impost relation:** Impost line is 10 cm lower than central line

**Impost - wall relation:** Impost is flush with the wall plane

**Dome height / Dome span, Ratio:** 1.60 m / 3.00 m, 0.53

**Dome thickness / Dome span, Ratio:** 0.60 m / 3.00 m, 0.20

**Height of transition element / Dome span, Ratio:** 1.43 m / 3.00 m, 0.47

### **The Men's Section, Northwest *Halvet* Dome (H03)**

Dome covers the square planned space that was juxtaposed to *sıcaklık* main space from northwest side with 3.05 x 3.90 m interior dimensions. The semi-circular arch profiled dome has interior span of 3.00 m and a dome height of 1.50 m. Thickness of the dome at the springing level is 60-65 cm and at the top of the dome 52-55 cm. The dome has a hexagonal shaped skylight with 25 cm opening dimension and oculi that are in two horizontal rows placed as equal-size hexagonal shape eight oculi in the exterior row while five oculi in the interior on the curved surface of the dome. The oculi are in a form having an opening with 18-19 cm interior while 14 cm exterior sizes with narrowing from interior towards exterior. The interior surface was plastered with horasan 1-1.5 cm in thickness. Transition to the dome was provided with pendentives 1.52 m in height. The dome was raised above two interior bases successively, below with an octagonal form of 30 cm and above with a circular form of 25 cm in height while settled directly on the walls on the exterior.



Figure A.83. Urla Hersekzade Ahmet Paşa Hamamı, interior and exterior views of northwest *halvet* dome in the men's section.

**Construction technique:** Northwest *halvet* dome was constructed with brick, stone and lime mortar as binder. The dome was covered with horasan plaster 1-1.5 cm in interior thickness while 6-8 cm on the exterior and coated with a thick layer of lime mortar 15-18 cm in thickness

including small and large pieces of slate stones, bricks and tiles. The bricks used in the bond are in the dimensions of 30-31 x 23-24 x 3-4 cm as whole bricks and 23-24 x 14-15 x 3-4 cm as half bricks. Dimensions of the slate stones in the bond are the same with the brick dimensions except thicknesses of the stones are between 5 and 8 cm. Both vertical and horizontal flush joints have dimensions between 1.5 and 2.5 cm in interior width, while between 3 and 4 cm on the exterior.

**Bond type:** Irregular brick / stone bond

**Lighting elements: Skylight on the top, oculi on the curved surfaces**

**Construction technique:** Skylight and oculi were formed with brick bond. The skylight was formed in a hexagonal shape opening on the top of dome, which was arranged by stacking long surfaces of the half-bricks side by side in perpendicular order to the horizontal plane in the dome thickness. Between the half-bricks forming the hexagonal shaped opening and whole bricks stacked radial towards the center of the dome forming the dome thickness were filled with lime mortar including brick pieces and dust. Oculi were formed with brick bond in which the bricks were stacked long surfaces forming hexagonal shaped openings in the dome thickness. The surfaces of the oculi and skylight were formed with lime mortar coating that included small brick pieces and plastered with horasan. The surface was covered with horasan plaster 1-1.5 cm in interior thickness.

**Volume:** Semi circular

**Profile:** Semi circular arc

**Center number:** 1

**Center height:** 1.50 m

**Dome span:** 3.00 m

**Impost height (dome height):** 1.50 m

**Dome thickness:** 0.65 m

**Impost line:** The same level with central line

**Center - impost relation:** Impost line is the same with central line

**Impost - wall relation:** Impost is flush with the wall plane

**Dome height / Dome span, Ratio:** 1.50 m / 3.00 m, 0.50

**Dome thickness / Dome span, Ratio:** 0.65 m / 3.00 m, 0.21

**Height of transition element / Dome span, Ratio:** 1.52 m / 3.00 m, 0.50

**The Women's Section, *Ilıklık* Dome (I02)**

The dome covers the square planned *ilıklık* central unit with 2.37 x 2.44 m interior dimensions. The depressed arch profiled dome has interior span of 2.25 m and a dome height of

0.75 m. Thickness of the dome at the springing level is 40-45 cm and at the top of the dome 35-40 cm. The dome has circular shaped oculi in two horizontal rows by placing three oculi in the interior row while four oculi in the exterior row on the curved surface of the dome, with the oculi in the interior row smaller than the oculi on the exterior. The oculi are in a form having an opening with 23-24 cm interior and 17-18 cm exterior size in the interior row while with 17-18 cm interior and 13-14 cm exterior size in the interior row with narrowing from interior towards exterior. The interior surfaces were plastered with horasan 1-1.5 cm in thickness. Transition to the dome was provided with pendentives 1.16 m in height. The dome was raised above two interior bases successively, below with an octagonal form of 30 cm and above with a circular form of 25 cm in height while settled directly on the walls on the exterior.



Figure A.84. Urla Hersekzade Ahmet Paşa Hamamı, interior and exterior views of *İliklik* dome in the women's section.

**Construction technique:** *İliklik* dome of the women's section was constructed with brick and lime mortar as binder. The dome was covered with horasan plaster 1-1.5 cm in interior thickness while 5-8 cm on the exterior. The bricks used in the bond are in the dimensions of 30-31 x 11-12 x 4-4.5 cm and 23-24 x 14-15 x 4-4.5 cm as half bricks. Both vertical and horizontal flush joints have dimensions between 1.5 and 2.5 cm in width interior, while between 2 and 5 cm on the exterior.

**Bond type:** Horizontal stacking of the short side faces in places non-parallel rows.

**Lighting elements:** Skylight on the top, oculi on the curved surfaces

**Construction technique:** Skylight and oculi were formed with brick bond. The skylight was formed in a hexagonal shape opening on the top of dome, which was arranged by stacking long surfaces of the half-bricks side by side in perpendicular order to the horizontal plane in the dome thickness. Between the half-bricks forming the hexagonal shaped opening and whole bricks stacked radial towards the center of the dome forming the dome thickness were filled with lime mortar including brick pieces and dust. Oculi were formed with brick bond in which

the bricks were stacked long surfaces forming hexagonal shaped openings in the dome thickness. The surfaces of the oculi and skylight were formed with lime mortar coating that included small brick pieces and plastered with horasan. The surface was covered with horasan plaster 1-1.5 cm in interior thickness while 5-8 cm on the exterior.

**Volume:** Depressed

**Profile:** Depressed arc

**Center number:** 1

**Center height:** 1.13 m

**Dome span:** 2.25 m

**Impost height (dome height):** 0.75 m

**Dome thickness:** 0.45 m

**Impost line:** Raised

**Center - impost relation:** Impost line is 38 cm higher than central line

**Impost - wall relation:** Impost is 19-20 cm from wall plane to the interior side

**Dome height / Dome span, Ratio:** 0.75 m / 2.25 m, 0.33

**Dome thickness / Dome span, Ratio:** 0.45 m / 2.25 m, 0.20

**Height of transition element / Dome span, Ratio:** 1.16 m / 2.25 m, 0.51

#### **The Women's Section, *Ilıklık* Sub-unit (*Tıraşlık*) Dome (IY01)**

The dome covers the square planned space that was juxtaposed to *ilıklık* central unit from northwest side with 2.55 x 2.70 m interior dimensions. The depressed arch profiled dome has interior span of 2.25 m and a dome height of 1.01 m. Thickness of the dome could not be determined due to the dome being filled with debris on the exterior. The dome has a skylight in a square shape on the top with an opening dimension of 30 cm and three pentagonal shaped oculi in one horizontal row and equal-size on the curved surface of the dome. The oculi are in a form having an opening with 23-24 cm on the interior while no determination on the exterior, however, with narrowing from interior towards exterior and interior surfaces of which were plastered with horasan 1-1.5 cm in thickness. Transition to the dome was provided with Turkish triangles 0.76 m in height. The dome was raised above a circular base 30 cm in interior height while settled directly on the walls on the exterior.



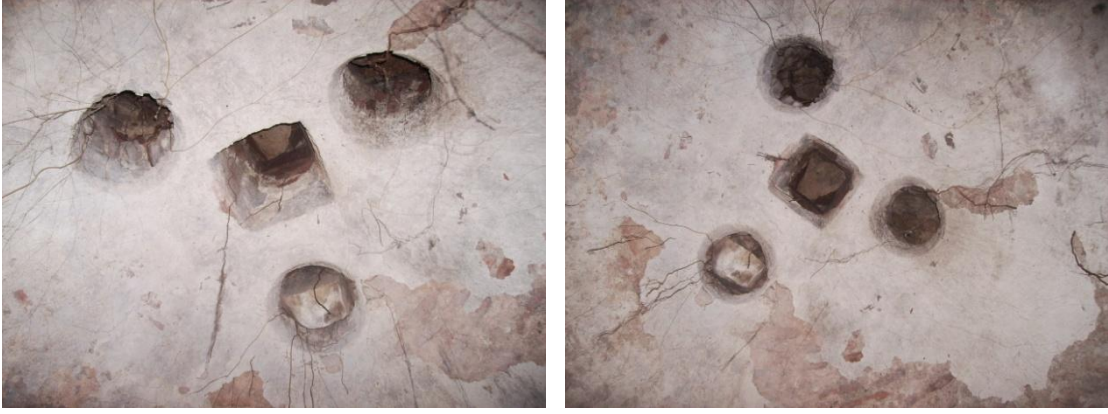

Figure A.85. Urla Hersekzade Ahmet Paşa Hamamı, interior views of *ılıklik* sub-unit dome in the women's section.

**Construction technique:** The construction technique of the dome could not be determined due to the surfaces being plastered on the interior and being filled with debris and soil on the exterior.

**Volume:** Depressed

**Profile:** Depressed arc

**Center number:** 1

**Center height:** 1.13 m

**Dome span:** 2.25 m

**Impost height (dome height):** 1.01 m

**Dome thickness:** Could not be determined

**Impost line:** Raised

**Center - impost relation:** Impost line is 12-15 cm higher than central line

**Impost - wall relation:** Impost is 15-20 cm from wall plane to the interior side

**Dome height / Dome span, Ratio:** 1.01 m / 2.25 m, 0.44

**Height of transition element / Dome span, Ratio:** 0.76 m / 2.25 m, 0.33

#### The Women's Section, the Central Unit Dome of *Sıcaklık* Main Space (S02)

The rectangular planned *sıcaklık* main space, which has interior dimensions of 3.95 x 9.46 m, was covered with barrel vaults in the southeast and northwest sub-units and with dome in the central unit. *Sıcaklık* main space dome covers the square planned middle unit with the interior dimensions of 3.87 x 3.94 m. The octagonal pyramidal and in the middle depressed arch profiled central unit dome has an interior span of 3.70 m and a height of 1.90 m. Thickness of the dome at the springing level is 60-65 cm and at the top of the dome 45-50 cm.

The dome has lighting cupola, on the top of which hexagonal shaped oculi were placed, with a 70 cm opening formed in circular frame of the base and oculi that are in three

horizontal rows with equal-size hexagonal shape sixteen oculi in the exterior row eight oculi in the interior row of the exterior two rows placed on the octagonal surfaces of the dome while eight oculi in the interior row placed in the depressed arch profiled part of the dome. The oculi placed in the two exterior rows were arranged as binary in the exterior row while one in the middle row forming triple order on each surface of octagonal pyramidal dome. In addition, eight oculi were placed in the interior row on the curved surface of the dome, started as octagonal pyramidal profile at the springing and converted into depressed arch profile at the certain level. The oculi placed in the interior row has a smaller size than two exterior rows. The oculi are in a form having an opening with 23-24 cm interior and 17-18 cm exterior size in the interior row, while with 35 cm interior and 20 cm exterior size in two exterior rows with narrowing from interior towards exterior and interior surfaces of which were plastered with horasan 1-1.5 cm in thickness.

Transition to the dome was provided with pendentives 2.95 m in height. The dome was raised above an octagonal base 26 cm in interior height while supported by an octagonal exterior drum with 50-70 cm height.



Figure A.86. Urla Hersekzade Ahmet Paşa Hamami, interior and exterior views of *sıcaklık* main space dome in the women's section.

**Construction technique:** Dome was constructed with brick and lime mortar as binder. The dome was covered with horasan plaster 1-1.5 cm in interior thickness while 4-5 cm on the

exterior. The bricks used in the bond are in the dimensions of 30-31 x 23-24 x 4-4.5 cm as whole bricks and 23-24 x 14-15 x 4-4.5 cm as half bricks. Both vertical and horizontal flush joints have dimensions between 1.5 and 2.5 cm in interior width, while between 3 and 5 cm on the exterior.

**Bond type:** Horizontal stacking of the short side faces in places non-parallel rows in order to constitute octagonal pyramidal form at the inclined surfaces while to constitute depressed circular form at the curved surfaces on the top of the dome.

**Lighting elements: Lighting cupola on the top, oculi on the curved surfaces**

**Construction technique:** Lighting cupola on the top and oculi were formed with brick bond.

Lighting cupola on the top was formed with a circular frame on the top of the dome with 60 cm span, which was arranged by stacking long surfaces of the half-bricks side by side in perpendicular order to the horizontal plane in the dome thickness. Between the half-bricks forming the circular frame and whole bricks stacked radial towards the center of the dome forming the dome thickness were filled with lime mortar including brick pieces and dust. Upper side of the cupola was formed with brick bond arranged by half-bricks 15 cm in thickness overlapped radial towards the cupola center. The surface was covered with horasan plaster 1-1.5 cm in interior thickness while 4-5 cm on the exterior.

Oculi, as well as the oculi on *ilıklık* dome, were formed with brick bond in which the bricks were stacked long surfaces forming hexagonal openings in the dome thickness. Oculi, narrowed from interior to exterior, have 17-18 cm interior span and 13-14 cm exterior in the interior row, whereas 23-24 cm interior span and 17-18 cm exterior in the two exterior rows. The hexagonal forms of oculi were formed with lime mortar including brick pieces and dust. Over the lime mortar forming, the exterior surfaces of the oculi were plastered with horasan 1-1.5 cm in thickness.

**Volume:** Pointed pyramidal

**Profile:** Truncated pyramid (isosceles trapezoid)

**Center height:** 1.85 m

**Dome span:** 3.70 m

**Impost height (dome height):** 1.90 m

**Dome thickness:** 0.65 m

**Impost line:** Lowered

**Center - impost relation:** Impost line is 5-10 cm lower than central line

**Impost - wall relation:** Impost is flush with the wall plane

**Dome height / Dome span, Ratio:** 1.90 m / 3.70 m, 0.51

**Dome thickness / Dome span, Ratio:** 0.65 m / 3.70 m, 0.17

**Height of transition element / Dome span, Ratio:** 2.95 m / 3.70 m, 0.79

**Height of exterior supporting element / Dome span, Ratio:** 0.70 m / 3.70 m, 0.19

#### **The Women's Section, Southeast *Halvet* Dome (KH01)**

The dome covers the square planned space that was juxtaposed to *sıcaklık* main space from southeast side with 3.75 x 3.79 m interior dimensions. The slightly depressed semi-circular arch profiled dome has interior span of 3.56 m and a dome height of 1.64 m. Thickness of the dome at the springing level is 60-65 cm and at the top of the dome 52-55 cm. The dome has oculi in three horizontal rows placed as equal-size hexagonal shape eight oculi in the two exterior rows while three oculi in the interior on the curved surface of the dome. There is no arrangement of lighting element on the top of the dome in the center. The oculi are in a form having an opening with 23-24 cm interior while 17-18 cm exterior size with narrowing from interior towards exterior and interior surfaces of which were plastered with horasan 1-1.5 cm in thickness. Transition to the dome was provided with pendentives 1.65 m in height. The dome was raised above a circular base of 25 cm in height on the interior while settled directly on the walls on the exterior.



Figure A.87. Urla Hersekzade Ahmet Paşa Hamamı, interior and exterior views of southeast *halvet* dome in the women's section.

**Construction technique:** Dome was constructed with brick and lime mortar as binder. The dome was covered with horasan plaster 1-1.5 cm in interior thickness while 6-8 cm on the exterior. The bricks used in the bond are in the dimensions of 27-28 x 17-18 x 4-4.5 cm as whole bricks and 23-24 x 14-15 x 4-4.5 cm as half bricks. Both vertical and horizontal flush joints have dimensions between 1.5 and 2.5 cm in interior width, while between 3 and 4 cm on the exterior.

**Bond type:** Horizontal stacking of the short side faces in places non-parallel rows as placing double row brick along thickness.

**Lighting elements: Oculi on the curved surfaces**

**Construction technique:** Oculi were formed with brick bond in which the bricks were stacked long surfaces forming hexagonal shaped openings in the dome thickness. The surfaces of the oculi and skylight were formed with lime mortar coating that included small brick pieces and plastered with horasan. The surface was covered with horasan plaster 1-1.5 cm in interior thickness while 6-8 cm on the exterior.

**Volume:** Depressed

**Profile:** Depressed arc

**Center number:** 2

**Distance between two centers:** 25 cm

**Center height:** 1.78 m

**Dome span:** 3.56 m

**Impost height (dome height):** 1.64 m

**Dome thickness:** 0.65 m

**Impost line:** Raised

**Center - impost relation:** Impost line is 14-15 cm higher than central line

**Impost - wall relation:** Impost is 8-10 cm from wall plane to the interior side

**Dome height / Dome span, Ratio:** 1.64 m / 3.56 m, 0.46

**Dome thickness / Dome span, Ratio:** 0.65 m / 3.56 m, 0.18

**Height of transition element / Dome span, Ratio:** 1.65 m / 3.56 m, 0.46

**The Women's Section, Southwest Halvet Dome (KH02)**

The dome covers the square planned space that was juxtaposed to *sıcaklık* main space from southwest side with 3.71 x 3.72 m interior dimensions. The depressed arch profiled dome has interior span of 3.52 m and a dome height of 1.65 m. Thickness of the dome at the springing level is 60-65 cm and at the top of the dome 52-55 cm. The dome has oculi in three horizontal rows placed as equal-size hexagonal shape nine oculi in the exterior, five oculi in the middle, and four oculi in the interior row on the curved surface of the dome. There is no arrangement of lighting element on the top of the dome in the center. The oculi are in a form having an opening with 23-24 cm interior while 17-18 cm exterior size with narrowing from interior towards exterior and interior surfaces of which were plastered with horasan 1-1.5 cm in thickness. Transition to the dome was provided with pendentives 1.75 m in height. The dome was raised above a circular base of 25 cm in height on the interior while settled directly on the walls on the exterior.



Figure A.88. Urla Hersekzade Ahmet Paşa Hamamı, interior and exterior views of southwest *halvet* dome in the women's section.

**Construction technique:** Dome was constructed with brick and lime mortar as binder. The dome was covered with horasan plaster 1-1.5 cm in interior thickness while 6-8 cm on the exterior. The bricks used in the bond are in the dimensions of 27-28 x 17-18 x 4-4.5 cm as whole bricks and 23-24 x 14-15 x 4-4.5 cm as half bricks. Both vertical and horizontal flush joints have dimensions between 1.5 and 2.5 cm in interior width, while between 3 and 4 cm on the exterior.

**Bond type:** Horizontal stacking of the short side faces in places non-parallel rows as placing double row brick along thickness.

**Lighting elements: Skylight on the top, oculi on the curved surfaces**

**Construction technique:** Skylight and oculi were formed with brick bond as the lighting elements in the southeast *halvet* dome. The skylight was formed in a hexagonal shape opening on the top of dome, which was arranged by stacking long surfaces of the half-bricks side by side in perpendicular order to the horizontal plane in the dome thickness. Between the half-bricks forming the hexagonal shape opening and the whole bricks stacked radial towards the center of the dome forming the dome thickness were filled with lime mortar including brick pieces and dust. Oculi, which were formed the same as the oculi in the southeast *halvet*, were formed with brick bond in which the bricks were stacked long surfaces forming hexagonal shape openings in the dome thickness. The surfaces of the oculi and skylight were formed with lime mortar coating that included small brick pieces and plastered with horasan. The surface was covered with horasan plaster 1-1.5 cm in interior thickness while 6-8 cm on the exterior.

**Volume:** Depressed

**Profile:** Depressed arc

**Center number:** 2

**Distance between two centers:** 20 cm

**Center height:** 1.76 m

**Dome span:** 3.52 m

**Impost height (dome height):** 1.65 m

**Dome thickness:** 0.65 m

**Impost line:** Raised

**Center - impost relation:** Impost line is 10-13 cm higher than central line

**Impost - wall relation:** Impost is 5-8 cm from wall plane to the interior side

**Dome height / Dome span, Ratio:** 1.65 m / 3.52 m, 0.46

**Dome thickness / Dome span, Ratio:** 0.65 m / 3.52 m, 0.18

**Height of transition element / Dome span, Ratio:** 1.75 m / 3.52 m, 0.49

### **1. Construction Date**

The *hamam* has no inscription. It can be dated back to the 15<sup>th</sup> century taking into consideration the square planned domed *ılıklık* central unit extending to a vaulted unit to one side, the muqarnas decorated pendentives and fountain niche in *sıcaklık* main space, and the belts of Turkish triangles and lobed squinches as transition elements at the corner of the *halvets* (Akyıldız 1988; Önge 1995; Çakmak 2002; Reyhan 2004).



Figure A.89. Urla Kamanlı Hamamı, a general view of superstructure (2004).

### **2. Plan Characteristics**

The *hamam* is composed in a plan organization from south to north *soyunmalık*, a rectangular planned *ılıklık*, *sıcaklık* main space and square planned three corner *halvets*. In addition, in the north part there is a rectangular planned water reservoir. However, *soyunmalık* is lost except for some wall remains and the dome of *ılıklık* central unit is collapsed today. The square planned central unit of *ılıklık* and *sıcaklık* main space, and the corner *halvets* were covered with domes while the rectangular planned *ılıklık* sub-unit, *sıcaklık* main space side units and water reservoir were covered with barrel vaults. The *hamam* can be evaluated in the plan type of elongated *sıcaklık* with domed central unit and two *halvets* (Eyice 1960), but here there are three *halvets*.



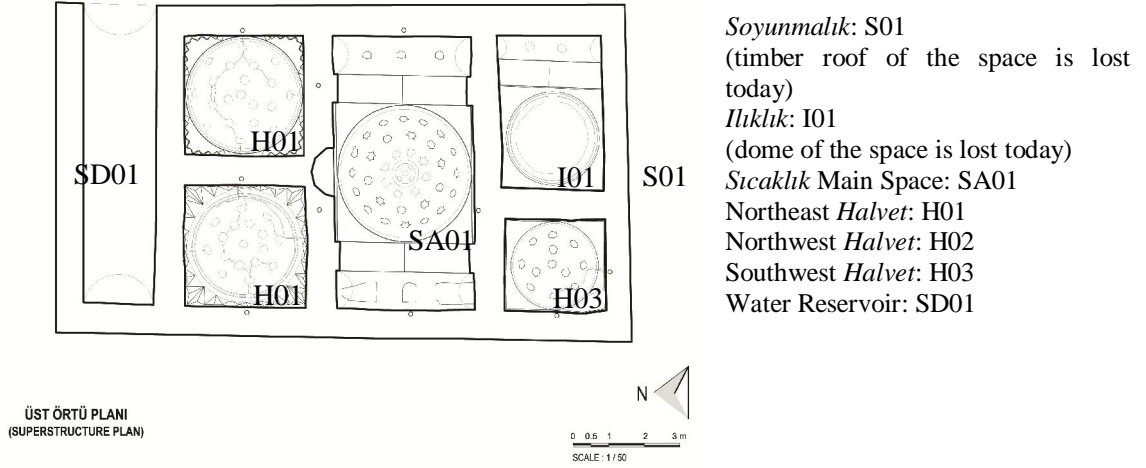

Figure A.90. Urla Kamanlı (Yahşi Bey) Hamamı, Plan (İYTE\_from the archive of the department of Architectural Restoration. Plan drawing was prepared during the studio work named “RES 502 Design in Architectural Restoration II” in the spring term of 2008-2009 education semesters)

### 3. Definition of Domes

#### *Ilıklık* Dome (I01)

*Ilıklık* dome covers the square planned central unit of rectangular planned space with the interior dimensions of 2.85 x 4.27 m. The dome was supported by barrel vault at the east. Dome, the upper part of which from the springing level towards the top is collapsed today, has an interior span of 2.95 m. However, height of the dome could not be determined due to being collapsed. Thickness of the dome is 45-50 cm at the springing level of the dome. The lighting order and lighting elements on the curved surface of the dome and on the top could not be determined due to being collapsed. The interior surfaces of the dome were plastered with horasan 1-1.5 cm in thickness. Transition to the dome was provided with pendentives 1.30 cm in height. The dome was raised above a circular base 27 cm in interior height while settled directly on the walls on the exterior.



Figure A.91. Urla Kamanlı Hamamı, interior and exterior views of *ilıklık* dome.

**Construction technique:** *Ilıklık* dome was constructed with brick and lime mortar as binder. The dome was covered with horasan plaster 1-1.5 cm in interior thickness while 3-5 cm on the exterior. The bricks used in the bond are in the dimensions of 30-31 x 23-24 x 3.5-4 cm as whole bricks and 23-24 x 14-15 x 3.5-4 cm as half bricks. Both vertical and horizontal flush joints have dimensions between 1.5 and 2.5 cm in interior width, while between 2 and 5 cm on the exterior.

**Bond type:** Horizontal stacking of the short side faces in places non-parallel rows.

**Volume:** Could not be determined

**Profile:** Could not be determined

**Center height:** 1.48 m

**Dome span:** 2.95 m

**Impost height (dome height):** Could not be determined

**Dome thickness:** 0.50 m

**Impost - wall relation:** Impost is 5-10 cm from wall plane to the interior side

**Dome thickness / Dome span, Ratio:** 0.50 m / 2.95 m, 0.17

**Height of transition element / Dome span, Ratio:** 1.30 m / 2.95 m, 0.44

#### ***Sıcaklık* Main Space, the Central Unit Dome (SA01)**

The rectangular planned *sıcaklık* main space, which has interior dimensions of 3.30 x 7.75 m, was covered with barrel vaults in the east and west side units and with dome in the central unit. *Sıcaklık* main space dome covers the square planned middle unit with the interior dimensions of 3.85 x 3.85 m. The depressed pointed arch profiled central unit dome has an interior span of 3.56 m and a height of 1.10 m. Thickness of the dome at the springing level is 45-50 cm and at the top of the dome 35-40 cm.

The dome has a lighting cupola, on the top and curved surfaces of which hexagonal shape oculi were arranged smaller in size than the oculi placed on the curved surface of the

dome, with a 55 cm opening formed in circular frame at the base on the top of dome and equal-size star and hexagonal shape oculi that are in three horizontal rows on the curved surface of the dome. The oculi on the curved surfaces of the dome were placed as eight star shape oculi in the interior row, star and hexagonal shape oculi alternately ten in the middle row and sixteen in the exterior row. The oculi are in a form having an opening with 17-18 cm interior while 13-14 cm exterior size with narrowing from interior towards exterior and interior surfaces of which were plastered with horasan 1-1.5 cm in thickness.

Transition to the dome was provided with muqarnas decorated pendentives 1.46 m in height. The dome was raised above a circular base 26 cm in interior height while supported by an octagonal exterior drum 45-70 cm in height.

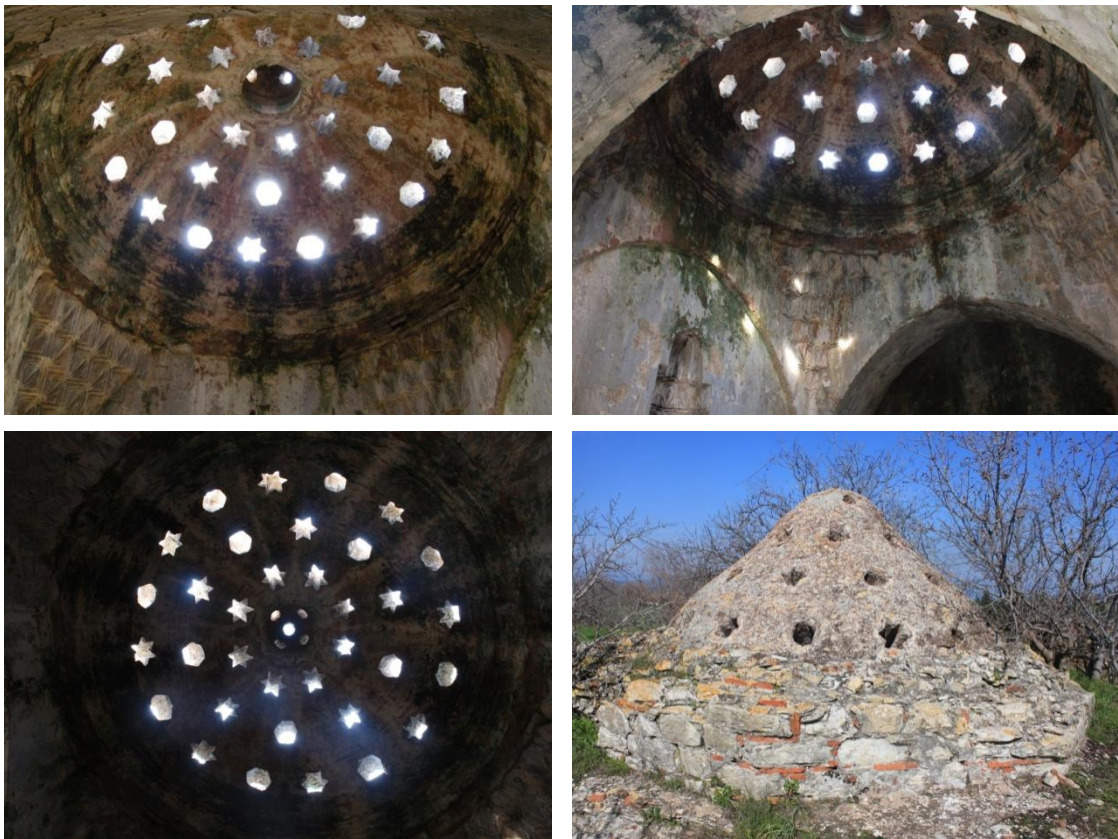

Figure A.92. Urla Kamanlı Hamamı, interior and exterior views of *sıcaklık* main space dome.

**Construction technique:** *Sıcaklık* main space dome was constructed with brick and lime mortar as binder. The dome was covered with horasan plaster 1-1.5 cm in interior thickness while 4-5 cm on the exterior. The bricks used in the bond are in the dimensions of 30-31 x 23-24 x 3.5-4 cm as whole bricks and 23-24 x 14-15 x 3.5-4 cm as half bricks. Both vertical and horizontal flush joints have dimensions between 1.5 and 2.5 cm in interior width, while between 3 and 5 cm on the exterior.

**Bond type:** Horizontal stacking of the short side faces in places non-parallel rows.

**Lighting elements: Lighting cupola on the top, oculi on the curved surfaces**

**Construction technique:** Lighting cupola and oculi were formed with brick bond. The lighting cupola was formed with a circular frame on the top of dome, which was arranged by stacking long surfaces of the half-bricks side by side in perpendicular order to the horizontal plane in the dome thickness. Between the half-bricks forming the circular frame and whole bricks stacked radial towards the center of the dome forming the dome thickness were filled with lime mortar including brick pieces and dust. The curved upper side of lighting cupola was formed by stacking short surfaces of half-brick radial towards the center of the cupola forming the cupola thickness. The hexagonal shape oculi, smaller in size than the oculi placed on the surface of dome, were arranged on the surface of lighting cupola. The surface was covered with horasan plaster 1-1.5 cm in interior thickness while 4-5 cm on the exterior. Oculi were formed with brick bond in which the bricks were stacked long surfaces forming star and hexagonal shape openings in the dome thickness. The surfaces of the oculi and lighting cupola were formed with lime mortar coating that included small brick pieces and plastered with horasan.

**Volume:** Depressed pointed

**Profile:** Depressed pointed arc

**Center number:** 2

**Distance between two centers:** 35 cm

**Center height:** 1.78 m

**Dome span:** 3.56 m

**Impost height (dome height):** 1.10 m

**Dome thickness:** 0.50 m

**Impost line:** Raised

**Center - impost relation:** Impost line is 68 cm higher than central line

**Impost - wall relation:** Impost is 21-26 cm from wall plane to the interior side

**Dome height / Dome span, Ratio:** 1.10 m / 3.56 m, 0.30

**Dome thickness / Dome span, Ratio:** 0.50 m / 3.56 m, 0.14

**Height of transition element / Dome span, Ratio:** 1.46 m / 3.56 m, 0.41

**Height of exterior supporting element / Dome span, Ratio:** 0.70 m / 3.56 m, 0.19

**Northeast Halvet Dome (H01)**

Dome covers the square planned space that was juxtaposed to *sıcaklık* main space from northeast side with 3.31 x 3.34 m interior dimensions. The depressed arch profiled dome has interior span of 3.03 m and a dome height of 1.17 m. Thickness of the dome at the springing level is 40-45 cm and at the top of the dome 35-40 cm. The dome has an octagonal shape skylight on the top with 25 cm opening dimension and equal-size hexagonal shape oculi that are

in three horizontal rows placed as three oculi in the interior row and eight oculi in the two exterior rows on the curved surface of the dome. The oculi are in a form having an opening with 17-18 cm interior while 13-14 cm exterior size with narrowing from interior towards exterior and interior surfaces of which were plastered with horasan 1-1.5 cm in thickness. Transition to the dome was provided with lobbed squinches 1.10 m in height. The dome was raised above a circular base 25 cm in interior height while settled directly on the walls on the exterior.



Figure A.93. Urla Kamanlı Hamamı, interior and exterior views of northeast *halvet* dome.

**Construction technique:** Northeast *halvet* dome was constructed with brick and lime mortar as binder. The dome was covered with horasan plaster 1-1.5 cm in interior thickness while 6-8 cm on the exterior. The bricks used in the bond are in the dimensions of 30-31 x 23-24 x 3.5-4 cm as whole bricks and 23-24 x 14-15 x 3.5-4 cm as half bricks. Both vertical and horizontal flush joints have dimensions between 1.5 and 2.5 cm in interior width, while between 3 and 4 cm on the exterior.

**Bond type:** Horizontal stacking of the short side faces in places non-parallel rows.

**Lighting elements: Skylight on the top, oculi on the curved surfaces**

**Construction technique:** Skylight and oculi were formed with brick bond. The skylight was formed in an octagonal shape opening on the top of dome, which was arranged by stacking long surfaces of the half-bricks side by side in perpendicular order to the horizontal plane in the dome thickness. Between the half-bricks forming the octagonal shape opening and whole bricks stacked radial towards the center of the dome forming the dome thickness were filled with lime mortar including brick pieces and dust. Oculi, which were formed the same as the oculi in the other *halvet* domes, were formed with brick bond in which the bricks were stacked long surfaces forming hexagonal shape openings in the dome thickness. The surfaces of the oculi and skylight were formed with lime mortar coating that included small brick pieces and plastered with horasan. The surface was covered with horasan plaster 1-1.5 cm in interior thickness while 6-8 cm on the exterior.

**Volume:** Depressed

**Profile:** Depressed arc

**Center number:** 2

**Distance between two centers:** 16 cm

**Center height:** 1.52 m

**Dome span:** 3.03 m

**Impost height (dome height):** 1.17 m

**Dome thickness:** 0.45 m

**Impost line:** Raised

**Center - impost relation:** Impost line is 35 cm higher than central line

**Impost - wall relation:** Impost is 12-16 cm from wall plane to the interior side

**Dome height / Dome span, Ratio:** 1.17 m / 3.03 m, 0.38

**Dome thickness / Dome span, Ratio:** 0.45 m / 3.03 m, 0.14

**Height of transition element / Dome span, Ratio:** 1.10 m / 3.03 m, 0.36

**Northwest Halvet Dome (H02)**

The dome covers the square planned space that was juxtaposed to *sıcaklık* main space from northwest side with 3.39 x 3.42 m interior dimensions. The depressed arch profiled dome has interior span of 3.27 m and a dome height of 1.07 m. Thickness of the dome at the springing level is 40-45 cm and at the top of the dome 35-40 cm. The dome has an octagonal shape skylight on the top with 25 cm opening dimension and equal-size hexagonal shape oculi that are in two horizontal rows placed as eight oculi in each row on the curved surface of the dome. The oculi are in a form having an opening with 17-18 cm interior while 13-14 cm exterior size with narrowing from interior towards exterior and interior surfaces of which were plastered with

horasan 1-1.5 cm in thickness. Transition to the dome was provided with Turkish triangles 1.20 m in height. The dome was raised above a circular base 40 cm in interior height while settled directly on the walls on the exterior.



Figure A.94. Urla Kamanlı Hamami, interior and exterior views of northwest *halvet* dome.

**Construction technique:** Northwest *halvet* dome was constructed with brick and lime mortar as binder. The dome was covered with horasan plaster 1-1.5 cm in interior thickness while 6-8 cm on the exterior. The bricks used in the bond are in the dimensions of 30-31 x 23-24 x 3.5-4 cm as whole bricks and 23-24 x 14-15 x 3.5-4 cm as half bricks. Both vertical and horizontal flush joints have dimensions between 1.5 and 2.5 cm in interior width, while between 3 and 4 cm on the exterior.

**Bond type:** Horizontal stacking of the short side faces in places non-parallel rows.

**Lighting elements: Skylight on the top, oculi on the curved surfaces**

**Construction technique:** Skylight and oculi were formed with brick bond as well as the lighting elements in *sıcaklık* main space and northwest *halvet* domes. The skylight was formed in an octagonal shape opening on the top of dome, which was arranged by stacking long surfaces of the half-bricks side by side in perpendicular order to the horizontal plane in the dome thickness. Oculi, which were formed the same as the oculi in the other *halvet* domes, were

formed with brick bond in which the bricks were stacked long surfaces forming hexagonal shape openings in the dome thickness. The surfaces of the oculi and skylight were formed with lime mortar coating that included small brick pieces and plastered with horasan. The surface was covered with horasan plaster 1-1.5 cm in interior thickness while 6-8 cm on the exterior.

**Volume:** Depressed

**Profile:** Depressed arc

**Center number:** 1

**Center height:** 1.64 m

**Dome span:** 3.27 m

**Impost height (dome height):** 1.07 m

**Dome thickness:** 0.45 m

**Impost line:** Raised

**Center - impost relation:** Impost line is 57 cm higher than central line

**Impost - wall relation:** Impost is 6-10 cm from wall plane to the interior side

**Dome height / Dome span, Ratio:** 1.07 m / 3.27 m, 0.32

**Dome thickness / Dome span, Ratio:** 0.45 m / 3.27 m, 0.13

**Height of transition element / Dome span, Ratio:** 1.20 m / 3.27 m, 0.36

### **Southwest *Halvet* Dome (H03)**

The dome covers the square planned space that was juxtaposed to *sıcaklık* main space from southwest side with 2.56 x 2.85 m interior dimensions. The depressed arch profiled dome has interior span of 2.17 m and a dome height of 0.79 m. Thickness of the dome at the springing level is 47-55 cm and at the top of the dome 37-40 cm. The dome has an octagonal shape skylight on the top with 25 cm opening dimension and equal-size hexagonal shape oculi that are in two horizontal rows placed as three oculi in the interior row and eight oculi on the exterior row on the curved surface of the dome. The oculi are in a form having an opening with 17-18 cm interior while 13-14 cm exterior size with narrowing from interior towards exterior and interior surfaces of which were plastered with horasan 1-1.5 cm in thickness. Transition to the dome was provided with pendentives 1.45 m in height. The dome was raised above a circular base 10 cm in interior height while settled directly on the walls on the exterior.





Figure A.95. Urla Kamanlı Hamamı, interior and exterior views of southwest *halvet* dome.

**Construction technique:** Southwest *halvet* dome was constructed with brick and lime mortar as binder. The dome was covered with horasan plaster 1-1.5 cm in interior thickness while 4-5 cm on the exterior. The bricks used in the bond are in the dimensions of 30-31 x 23-24 x 3.5-4 cm as whole bricks and 23-24 x 14-15 x 3.5-4 cm as half bricks. Both vertical and horizontal flush joints have dimensions between 1.5 and 2.5 cm in interior width, while between 3 and 4 cm on the exterior.

**Bond type:** Horizontal stacking of the short side faces in places non-parallel rows.

**Lighting elements: Skylight on the top, oculi on the curved surfaces**

**Construction technique:** Skylight and oculi were formed with brick bond as the lighting elements in *sıcaklık* main space and *halvet* domes. The skylight was formed in an octagonal shape opening on the top of dome, which was arranged by stacking long surfaces of the half-bricks side by side in perpendicular order to the horizontal plane in the dome thickness. Oculi, which were formed the same as the oculi in the other *halvet* domes, were formed with brick bond in which the bricks were stacked long surfaces forming hexagonal shape openings in the dome thickness. The surfaces of the oculi and skylight were formed with lime mortar coating that included small brick pieces and plastered with horasan. The surface was covered with horasan plaster 1-1.5 cm in interior thickness while 4-5 cm on the exterior.

**Volume:** Depressed

**Profile:** Depressed arc

**Center number:** 1

**Center height:** 1.09 m

**Dome span:** 2.17 m

**Impost height (dome height):** 0.79 m

**Dome thickness:** 0.55 m

**Impost line:** Raised

**Center - impost relation:** Impost line is 30 cm higher than central line

**Impost - wall relation:** Impost is 21-26 cm from wall plane to the interior side

**Dome height / Dome span, Ratio:** 0.79 m / 2.17 m, 0.36

**Dome thickness / Dome span, Ratio:** 0.55 m / 2.17 m, 0.25

**Height of transition element / Dome span, Ratio:** 1.45 m / 2.17 m, 0.66

**Catalogue No: 16 – Construction Name: Urla Rüstem Paşa Hamamı**

**1. Construction Date**

The *hamam* has no inscription. It can be dated back to the 16<sup>th</sup> century taking into consideration two rows of muqarnas decorations on the interior base of the dome at the transition zone and the depressed pointed niches on the wall (Akyıldız 1988; Çakmak 2002; Reyhan 2004).



Figure A.96. Urla Rüstem Paşa Hamamı, a general view of superstructure (2008)

**2. Plan Characteristics**

Only a square planned domed space can be observed that remains today. In order to determine the plan type of the construction a further detailed excavation is needed.

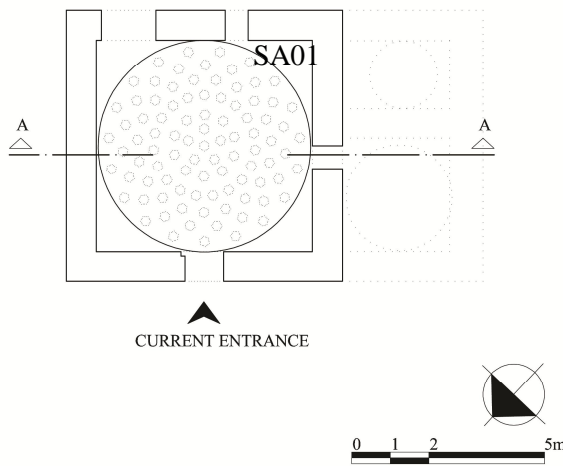

The square planned space: SA01

Figure A.97. Urla Rüstem Paşa Hamamı, Plan (2008).

### 3. Definition of Domes

#### Square Planned Space Dome (S01)

The dome covers the square planned space with the interior dimensions of 5.50 x 5.60 m. The depressed pointed arch profiled dome has an interior span of 5.30 m and a height of 3.51 m. Thickness of the dome at the springing level is 40-45 cm and at the top of the dome 35-40 cm.

The dome has an octagonal shape skylight on the top with 35 cm opening dimension and equal-size hexagonal shape oculi that are in six horizontal rows, placed as dense scattered and decreasing in number, from the springing level to the top on the curved surface of the dome. Nineteen oculi were placed in the exterior four rows while ten oculi took place in the second interior row and five oculi in the first interior row. The oculi are in a form having an opening with 17-18 cm interior while 13-14 cm exterior size with narrowing from interior towards exterior and interior surfaces of which were plastered with horasan 1-1.5 cm in thickness.

Transition to the dome was provided with pendentives 1.85 cm in height. The dome was raised above two interior bases successively, below with a hexagonal form of 23 cm and above with a circular form of 30 cm in height. The dome was supported by an octagonal exterior drum with 50-60 cm height.



Figure A.98. Urla Rüstem Paşa Hamamı, interior and exterior views of *sıcaklık* main space dome.

**Construction technique:** The space dome was constructed with brick and lime mortar as binder. The dome was covered with horasan plaster 1-1.5 cm in interior thickness while 6-8 cm on the exterior. The bricks used in the bond are in the dimensions of 30-31 x 21-22 x 3-4 cm as whole bricks and 30-31 x 10-12 x 3-4 cm and 21-22 x 15-16 x 3-4 cm as half bricks. Both vertical and horizontal flush joints have dimensions between 1.5 and 2.5 cm in interior width, while between 3 and 4 cm on the exterior.

**Bond type:** Horizontal and adjacent stacking of the short side faces in parallel rows.

**Lighting elements: Skylight on the top, oculi on the curved surfaces**

**Construction technique:** Skylight and oculi were formed with brick bond. The skylight was formed in an octagonal shape opening on the top of dome, which was arranged by stacking long surfaces of the half-bricks side by side in perpendicular order to the horizontal plane in the dome thickness. Between the half-bricks forming the octagonal shape opening and whole bricks stacked radial towards the center of the dome forming the dome thickness were filled with lime mortar including brick pieces and dust. Oculi were formed with brick bond in which the bricks were stacked long surfaces forming hexagonal shape openings in the dome thickness. The surfaces of the oculi and skylight were formed with lime mortar coating that included small brick pieces and plastered with horasan. The surfaces of the lighting elements were covered with horasan plaster 1-1.5 cm in interior thickness.

**Volume:** Depressed pointed

**Profile:** Depressed pointed arc

**Center number:** 2

**Distance between two centers:** 43 cm

**Center height:** 2.65 m

**Dome span:** 5.30 m

**Impost height (dome height):** 3.51 m

**Dome thickness:** 0.45 m

**Impost line:** Lowered

**Center - impost relation:** Impost line is 86 cm lower than central line

**Impost - wall relation:** Impost is 10-15 cm from wall plane to the interior side

**Dome height / Dome span, Ratio:** 3.51 m / 5.30 m, 0.66

**Dome thickness / Dome span, Ratio:** 0.45 m / 5.30 m, 0.08

**Height of transition element / Dome span, Ratio:** 1.85 m / 5.30 m, 0.35

**Height of exterior supporting element / Dome span, Ratio:** 0.60 m / 5.30 m, 0.11

**Catalogue No: 17 – Construction Name: Özbek Köyü Hamamı**

**1. Construction Date**

The *hamam* has no inscription. It can be dated back to the 16<sup>th</sup> century taking into consideration the window on the wall of *soyunmalık* space and the use of timber roof as superstructure in the *soyunmalık* space, traditional tiles covering the superstructure involving the domes and the vaults, and niches on the walls of *ılıklik / sıcaklik* main space and east *halvet* (Önge 1995; Çakmak 2002; Reyhan 2004).



Figure A.99. Özbek Köyü Hamamı, a general view of superstructure (2008).

**2. Plan Characteristics**

The *hamam* is composed in a plan organization from southwest to northeast *soyunmalık* covered with a timber roof, a rectangular planned *ılıklik / sıcaklik* main space and two corner *halvets* connected to each other. In addition, in the northeast part there is a rectangular planned water reservoir. The square planned central unit of *ılıklik / sıcaklik* main space and corner *halvets* were covered with domes while *soyunmalık* was covered with a timber roof and the rectangular planned *ılıklik / sıcaklik* main space side units and water reservoir were covered with barrel vaults. The *hamam* can be evaluated in the plan type of elongated *sıcaklik* with domed central unit and two *halvets* (Eyice 1960). However, the corner *halvets* were connected to each other in which the entrance is provided from *ılıklik / sıcaklik* main space to the northwest *halvet* and from there to the northeast *halvet*.

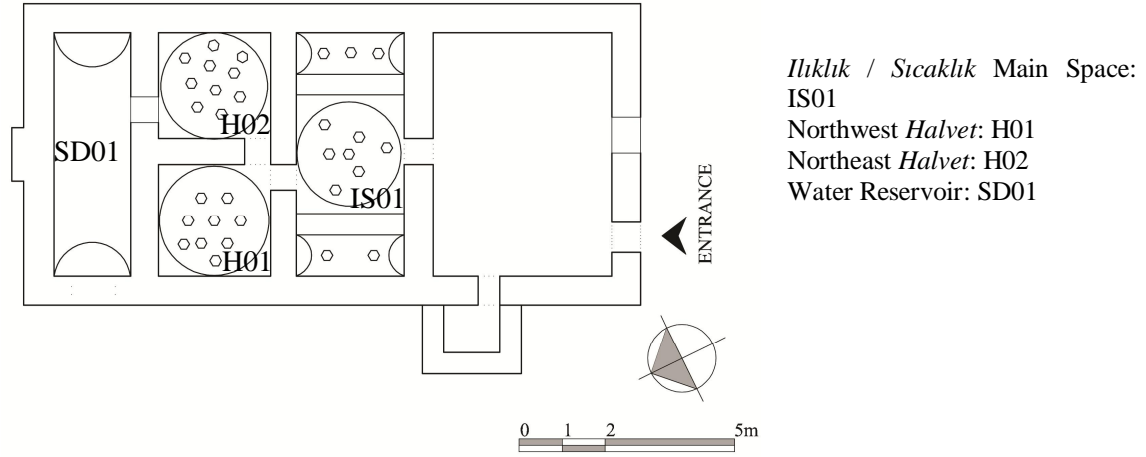

Figure A.100. Özbek Köyü Hamamı, Plan (2004).

### 3. Definition of Domes

#### *Ilıklık / Sıcaklık* Main Space Dome (IS01)

The rectangular planned *ilıklık / sıcaklık* main space, which has interior dimensions of 2.50 x 5.75 m, was covered with barrel vaults in the northeast and southwest side units and with dome in the central unit. *Ilıklık / sıcaklık* main space dome covers the square planned central unit with the interior dimensions of 2.50 x 2.55 m. The depressed arch profiled central unit dome has an interior span of 2.40 m and a height of 1.00 m. Thickness of the dome at the springing level is 40-45 cm and at the top of the dome 35-40 cm. The dome has a circular formed skylight with 20 cm opening dimension on the top and oculi that are in two horizontal rows with equal-size circular shape and placed as three oculi in each row on the curved surface of the dome. The oculi are in a form having an opening with 17-18 cm interior while 13-14 cm exterior size with narrowing from interior towards exterior and interior surfaces of which were plastered with horasan 1-1.5 cm in thickness. Transition to the dome was provided with pendentives 1.36 m in height. The dome was raised above a circular base 25 cm in interior height while settled directly on the walls on the exterior.





Figure A.101. Özbek Köyü Hamamı, interior and exterior views of *ılıklık / sıcaklık* main space dome.

**Construction technique:** *Ilıklık / sıcaklık* main space dome was constructed with brick and lime mortar as binder. The dome was covered with horasan plaster 1-1.5 cm in interior thickness while 3-5 cm on the exterior. Domes were coated with traditional tiles over the horasan plaster on the exterior. The bricks used in the bond are in the dimensions of 30-31 x 20-21 x 3-3.5 cm as whole bricks and 20-21 x 15-16 x 3-3.5 cm as half bricks. Both vertical and horizontal flush joints have dimensions between 1.5 and 2.5 cm in interior width, while between 3 and 5 cm on the exterior.

**Bond type:** Horizontal stacking of the short side faces in places non-parallel rows.

**Lighting elements:** Skylight on the top, oculi on the curved surfaces

**Construction technique:** Skylight was formed with brick bond. The skylight was formed with a circular shape opening on the top of dome, which was arranged by stacking long surfaces of the half-bricks side by side in perpendicular order to the horizontal plane in the dome thickness. Between the half-bricks forming the circular opening and whole bricks stacked radial towards the center of the dome forming the dome thickness were filled with lime mortar including brick pieces and dust. The surface of the skylight was formed with lime mortar coating including small brick pieces and plastered with horasan. Oculi, made of terracotta material and narrowed from interior to exterior in a truncated conical form, have 17-18 cm interior span while 13-14 cm exterior, 34 cm length and 1.5 cm thickness. Between the bricks stacked radial towards the center of the dome forming the dome thickness and the terracotta oculi were filled with lime mortar including brick pieces and dust. The surfaces of the terracotta pipes were plastered with horasan 1-1.5 cm in thickness.

**Volume:** Depressed

**Profile:** Depressed arc

**Center number:** 1

**Center height:** 1.20 m

**Dome span:** 2.40 m

**Impost height (dome height):** 1.00 m

**Dome thickness:** 0.45 m

**Impost line:** Raised

**Center - impost relation:** Impost line is 20 cm higher than central line

**Impost - wall relation:** Impost is 5-10 cm from wall plane to the interior side

**Dome height / Dome span, Ratio:** 1.00 m / 2.40 m, 0.41

**Dome thickness / Dome span, Ratio:** 0.45 m / 2.40 m, 0.18

**Height of transition element / Dome span, Ratio:** 1.36 m / 2.40 m, 0.56

### Northwest *Halvet* Dome (H01)

The dome covers the square planned space that was juxtaposed to *ılıklik / sıcaklik* main space from northwest side with 2.50 x 2.50 m interior dimensions. The depressed arch profiled dome has interior span of 2.28 m and a dome height of 0.87 m. Thickness of the dome at the springing level is 40-45 cm and at the top of the dome 35-40 cm. The dome has a circular formed skylight with 20 cm opening dimension on the top and oculi that are in two horizontal rows with equal-sized circular shape and placed as two oculi in the exterior row on the west side of the dome while six oculi in the interior row on the curved surface of the dome. The oculi are in a form having an opening with 17-18 cm interior while 13-14 cm exterior size with narrowing from interior towards exterior and interior surfaces of which were plastered with horasan 1-1.5 cm in thickness. Transition to the dome was provided with pendentives 1.61 m in height. The dome was raised above a circular base 25 cm in interior height while settled directly on the walls on the exterior.



Figure A.102. Özbek Köyü Hamamı, interior and exterior views of northwest *halvet* dome.

**Construction technique:** Northwest *halvet* dome was constructed with brick and lime mortar as binder. The dome was covered with horasan plaster 1-1.5 cm in interior thickness while 3-5

cm on the exterior. Domes were coated with traditional tiles over the horasan plaster on the exterior. The bricks used in the bond are in the dimensions of 30-31 x 20-21 x 3-3.5 cm as whole bricks and 20-21 x 15-16 x 3-3.5 cm as half bricks. Both vertical and horizontal flush joints have dimensions between 1.5 and 2.5 cm in interior width, while between 3 and 4 cm on the exterior.

**Bond type:** Horizontal stacking of the short side faces in places non-parallel rows.

**Lighting elements: Skylight on the top, oculi on the curved surfaces**

**Construction technique:** Skylight was formed with brick bond. The skylight was formed with a circular shape opening on the top of dome, which was arranged by stacking long surfaces of the half-bricks side by side in perpendicular order to the horizontal plane in the dome thickness. Between the half-bricks forming the circular opening and whole bricks stacked radial towards the center of the dome forming the dome thickness were filled with lime mortar including brick pieces and dust. The surface of the skylight was formed with lime mortar coating that included small brick pieces and plastered with horasan. Oculi, made of terracotta material and narrowed from interior to exterior in a truncated conical form, have 17-18 cm interior span while 13-14 cm exterior, 34 cm length and 1.5 cm thickness. Between the bricks stacked radial towards the center of the dome forming the dome thickness and the terracotta oculi were filled with lime mortar including brick pieces and dust. The surfaces of the terracotta pipes were plastered with horasan 1-1.5 cm in thickness.

**Volume:** Depressed

**Profile:** Depressed arc

**Center number:** 1

**Center height:** 1.14 m

**Dome span:** 2.28 m

**Impost height (dome height):** 0.87 m

**Dome thickness:** 0.45 m

**Impost line:** Raised

**Center - impost relation:** Impost line is 27 cm higher than central line

**Impost - wall relation:** Impost is 11-12 cm from wall plane to the interior side

**Dome height / Dome span, Ratio:** 0.87 m / 2.28 m, 0.38

**Dome thickness / Dome span, Ratio:** 0.45 m / 2.28 m, 0.19

**Height of transition element / Dome span, Ratio:** 1.61 m / 2.28 m, 0.70

### Northeast *Halvet* Dome (H02)

The dome covers the square planned space that was juxtaposed to *ılıklik / sıcaklik* main space from northeast side with 2.50 x 2.50 m interior dimensions. The semi-circular arch profiled dome has interior span of 2.25 m and a dome height of 1.10 m. Thickness of the dome at the springing level is 40-45 cm and at the top of the dome 35-40 cm. The dome has a circular formed skylight with 20 cm opening dimension on the top and oculi that are in two horizontal rows with equal-size circular shape and placed as three oculi in the exterior row on the east side of the dome while six oculi in the interior row on the curved surface of the dome. The oculi are in a form having an opening with 17-18 cm interior while 13-14 cm exterior size with narrowing from interior towards exterior and interior surfaces of which were plastered with horasan 1-1.5 cm in thickness. Transition to the dome was provided with pendentives 1.10 m in height. The dome was raised above a circular base 25 cm in interior height while settled directly on the walls on the exterior.



Figure A.103. Özbek Köyü Hamamı, interior and exterior views of northeast *halvet* dome.

**Construction technique:** Northeast *halvet* dome was constructed with brick and lime mortar as binder. The dome was covered with horasan plaster 1-1.5 cm in interior thickness while 6-8 cm on the exterior. Domes were coated with traditional tiles over the horasan plaster on the exterior. The bricks used in the bond are in the dimensions of 30-31 x 20-21 x 3-3.5 cm as whole bricks and 20-21 x 15-16 x 3-3.5 cm as half bricks. Both vertical and horizontal flush joints have dimensions between 1.5 and 2.5 cm in interior width, while between 3 and 4 cm on the exterior.

**Bond type:** Horizontal stacking of the short side faces in places non-parallel rows.

#### **Lighting elements: Skylight on the top, oculi on the curved surfaces**

**Construction technique:** Skylight was formed with brick bond. The skylight was formed with a circular shaped opening on the top of dome, which was arranged by stacking long surfaces of the half-bricks side by side in perpendicular order to the horizontal plane in the dome thickness. Between the half-bricks forming the circular opening and whole bricks stacked radial towards

the center of the dome forming the dome thickness were filled with lime mortar including brick pieces and dust. The surface of the skylight was formed with lime mortar coating including small brick pieces and plastered with horasan. Oculi, made of terracotta material and narrowed from interior to exterior in a truncated conical form, have 17-18 cm interior span while 13-14 cm exterior, 34 cm length and 1.5 cm thickness. Between the bricks stacked radial towards the center of the dome forming the dome thickness and the terracotta oculi were filled with lime mortar including brick pieces and dust. The surfaces of the terracotta pipes were plastered with horasan 1-1.5 cm in thickness.

**Volume:** Depressed

**Profile:** Depressed arc

**Center number:** 1

**Center height:** 1.13 m

**Dome span:** 2.25 m

**Impost height (dome height):** 1.10 m

**Dome thickness:** 0.45 m

**Impost line:** Raised

**Center-impost relation:** Impost line is 3-5 cm higher than central line

**Impost - wall relation:** Impost is 12-13 cm from wall plane to the interior side

**Dome height / Dome span, Ratio:** 1.10 m / 2.25 m, 0.38

**Dome thickness / Dome span, Ratio:** 0.45 m / 2.25 m, 0.19

**Height of transition element / Dome span, Ratio:** 1.10 m / 2.25 m, 0.70

# VITA

## PERSONAL INFORMATION

Date of Birth                   **1978**  
Place of Birth                   **Antakya**  
e-mail                           **kaderreyhan@iyte.edu.tr or kaderreyhan@gmail.com**

## EDUCATION

2004 – 2011                   **Ph.D. Program in Architecture**  
Izmir Institute of Technology, Faculty of Architecture,  
Dep. of Architecture, Izmir, Turkey.

2005-2006                   **Socrates; Department of Architecture**  
Universidade Lusófona de Humanidades e Tecnologias,  
Department of Architecture, Campo Grande 376,  
Lisbon-Portugal

2001 – 2004                   **Master of Science Program in Architectural Restoration**  
Izmir Institute of Technology, Faculty of Architecture,  
Dep. of Architectural Restoration, Izmir, Turkey.

2000 – 2001                   **Non-Degree Advanced English Education Course**  
Izmir Institute of Technology, Graduate School of Engineering  
and Science, The English Preparatory School, Izmir, Turkey.

1995 – 2000                   **Bachelor of Architecture**  
Çukurova University, Dep. of Architecture, Adana, Turkey.

## WORK EXPERIENCE

2002 – 2010                   **Research and Teaching Assistant**  
Izmir Institute of Technology, Faculty of Architecture, Izmir,  
Turkey.

## RESEARCH INTERESTS

Primary Interests           Historical Construction Technology; Architectural  
Characteristics and Construction Techniques; Historical  
Buildings and Sites; Architecture; Architectural Restoration.

Secondary Interests       Building Technology in Science.