

The Architectural Application of Altmann Linkage as a Light Shelf

Fulya ATARER*, Z.Tuğçe KAZANASMAZ^a, Koray KORKMAZ^a, Gökhan KİPER^b

*İzmir Institute of Technology, Department of Architecture, İzmir, Turkey
Gülbahçe, 35430, İzmir, Turkey
fulya.atarer@gmail.com

^a İzmir Institute of Technology, Department of Architecture, İzmir, Turkey

^b İzmir Institute of Technology, Department of Mechanical Engineering, İzmir, Turkey

Abstract

Daylight and its penetration in a room are significant concerns in architectural design. Light shelves are necessary to control daylight on fenestration. In the literature, there are many daylight controller systems such as light shelves. This paper presents the possibility of using Altmann linkage as the basis of constructing such a light shelf in rectangular form. It is basically a horizontal or inclined device, having high reflectance on the upper surface to control and redistribute daylight, placed above the eye-level in the fenestration system. The performance of a light shelf varies according to its dimensions, distance to window sill, distance to window head, its rotation angle and orientation in terms of daylight efficiency and visual comfort. It is also used to provide shading. This system can be internal or external and being static or movable. A light shelf presents its maximum efficiency in south facing façades receiving higher direct sun incident angles in medium latitudes of northern hemisphere. The aim of this study is to explain the design process of an adaptable Altmann light shelf including dimensioning the links in a rectangular form, calculating rotation angles, modelling this device in Relux to test its daylight performance. Regarding the Altmann geometries, three variations are set while changing its distance to window sill. The aim is to test illuminance and uniformity. Relux calculates illuminance and uniformity at four significant dates and three chosen hours for each one, to obtain the best design.

Keywords: Light Shelf, Altmann Linkage, Adaptive Façade, Daylight, Redirection

Introduction

A light shelf is a kind of the improved daylight system. The function of a light shelf is to reflect daylight deep inside a space providing uniformity. It is applied in the fenestration system horizontally on the external or the internal or both side of the façade with a considerable reflective upper surface (Freewan, 2010). It keeps away from the direct sun light and reduces possible heat gain and glare occurrence in the room because of providing shading additionally. Its dimension, its location, and its material reflectance, the shape of the room, room surfaces, and ceiling geometry are significant design properties of a light shelf for its highly influenced performance (Soler&Otezia, 1997).

Literature cites several studies based on best performance light shelf design. Soler and Oteiza (1996), and Claros and Soler (2002) studied to design for increasing the performance of light shelf on solar geometry according to solar angle. They studied on 1:10 scale model (0.60 m x 0.60 m x 0.28 m), and the both sides horizontal light shelf's dimensions were 0.56 m x 0.14 m and its high from the bottom 0.20 m. Ochoa and Capeluto (2006) compared illuminance between horizontal both sided light shelf and anidolic light shelf. While horizontal light shelf was appropriate for South and partially appropriate for East and West, anidolic light shelf moderately performed suitable for all directions. Beltran et al. (1997) analyzed many light shelf systems like horizontal, single level, and multi-level. Kurtay and Esen (2017) designed a special curves light shelf called CUN-OKAY to improve the performance of light shelf. Another interesting study is that designed a light shelf with a solar module based on the solar module attachment area (Lee, 2019). Though the above examples have mentioned only fixed type of light shelves, in recent years, the focus has been directed to movable versions either towards the sun or tracking the sun to enhance the device performance. While Chan and Tzempelikos (2015) have designed one direction movable light shelf that the light shelf is fixed on one hand with joints and moved up/down, Lee et al. (2016) have designed two-direction movable light shelf that the light shelf is fixed two different sides and moved up/down or right/left. Despite of studies dealing with movable light shelves, their action of movement is limited either in e.g. x-axis which is aligned to the façade or in e.g. perpendicular to the façade similar to the movements of horizontal and vertical blinds. That action of movement does not change the form of light shelf. In the previous study, we designed for both sides 9 light shelves – 5 of them are 0.60 m x 0.60 m and 4 of them are 0.70 m x 0.70 m in dimension– based on like an Altmann mechanism. We analysed and compared without light shelf and two different version of the light shelf (Atarer et. al., 2017). Now, this study indicates the performance of the differences among three light shelves calculating their position analysis.

Project Description

The light shelf was assembled for a room used as an office for academicians of architecture. The case room is located on the third floor of an Architectural building in the İzmir Institute of Technology as shown in Figure 1 which is highlighted with red rectangle. The building is situated in a campus in İzmir (latitude 38°3'N; longitude 27°1'E). Dimension and details are based on feasible deep room, which is 2.85 m width, 6.45 m length and 3.80 m height (Figure). The window has 2.00 m width and 2.00 m height in the southern part located 1.00 m higher than the floor. The light shelf is also located 2.45 m higher than the floor. The surface reflectance and materials are 65% - coarse-grained granite for floor; 90% - white plaster for ceiling; 92% - grey plaster for walls; 78% - for glass; 97% - silver metal for light shelves; 65% - plastic for table as shown Table 1.



Figure 1. Case Room at the Architectural department of IZTECH.



Figure 2. Plane and Indoor of Case Room.

Table 1: The reflectance value of materials

Components and Materials	Surface Reflectance
Floor: Coarse-grained	65%
Ceiling: White plaster	90%
Wall: Grey plaster	92%
Glass	78%
Light Shelf: Silver metal	97%
Table: Plastic	65%

This study examines the possibility of designing a movable light shelf using Altmann linkages for the movement. The Altmann (1954) is a single DoF single loop overconstrained 6R linkage. It is a special case of Bricard's line-symmetric linkage. This mechanism moves like folding diagonally. **Error! Reference source not found.** illustrates the movement of the Altmann linkage. In order to obtain a better light shelf, this plate which is inspired by the movement geometry of the Altmann linkage, as shown in **Error! Reference source not found.** is used. To get a better understanding the geometric properties of overconstrained mechanisms, Denavit- Hartenberg method can be used for their position analysis.

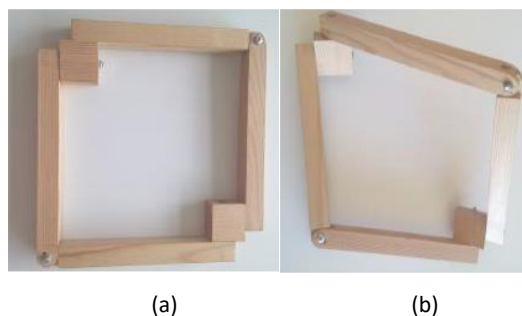

Figure 3. (a) Deployed configuration of Altmann linkage, (b) Semi-deployed (45° angle) configuration of Altmann linkage.

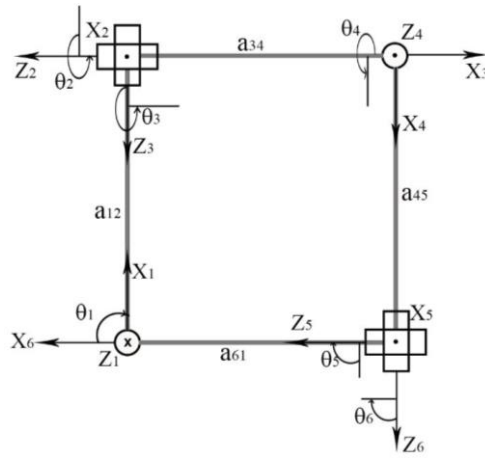

Figure 4. The Schema of Denavit-Hartenberg parameters of Altmann linkage

The schema of D-H parameters of Altmann Linkage **Error! Reference source not found.** and **Error! Reference source not found.** is created. According to **Error! Reference source not found.4**;

$\alpha_{12} = \pi/2$, $\alpha_{23} = \pi/2$, $\alpha_{34} = -\pi/2$, $\alpha_{45} = \pi/2$, $\alpha_{56} = \pi/2$ and $\alpha_{61} = -\pi/2$ as in Baker's (1993) representation. In calculation of this over-constrained linkage, a_{23} and a_{56} are equal to zero because of geometric conditions. Also, all "d" values are equal to zero as shown in **Error! Reference source not found.2**. Thanks to geometric properties of Altmann linkage, the daylight can be better transmitter in the deep office room which has South façade as the sun rises and sets. Therefore, angles of the Altmann linkage calculate as follows:

Table 2: D-H parameters of Altmann Linkage

i	θ_{ij}	d_i	a_{ij}	α_{ij}
1	θ_1	0	a_{12}	α_{12}
2	θ_2	0	$a_{23}=0$	α_{23}
3	θ_3	0	a_{34}	α_{34}
4	θ_4	0	a_{45}	α_{45}
5	θ_5	0	$a_{56}=0$	α_{56}
6	θ_6	0	a_{61}	α_{61}

$$\theta_2 = a \tan \left(\frac{\tau \sqrt{2c\theta_1(1+c\theta_1)}}{-s\theta_1} \right) = a \tan \left(\frac{\tau \sqrt{c\theta_1}}{-s(\theta_1/2)} \right) \quad (1)$$

$$\theta_3 = \pi - \theta_2 \quad (2)$$

This study is to examine an Altmann light shelf which is designed different dimensions for a window. The Altmann linkage has six links including reciprocal links are equal and two links are equal to zero because of the geometric properties as mentioned in previous chapter. For designing as a light shelf, two distances of joints which are "a" (long link) and "b" (short link) are important as shown in **Error! Reference source not found.**

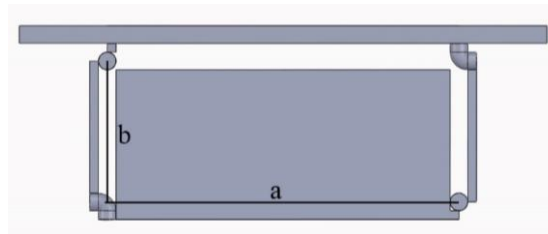

Figure 5. Altmann light shelf

For comparison of efficiency using daylight, the dimensions of the chosen external light shelf are such that 80 cm, 55 cm and 15 cm as shown "b" and constant "a" (window width), each are calculated and analyzed. In Figure 6, when link "b" of the three different designed light shelf is moved with the same angle like θ_1 , each designed light shelf has different angles which are the angle with the building ($\beta_{80}, \beta_{55}, \beta_{15}$) and the angle with the west ($\gamma_{80}, \gamma_{55}, \gamma_{15}$). The shortest one has a minimum angle with both building and west (β_{15}, γ_{15}) (**Error! Reference source not found.6-c**). When link "b" is extended, the angle is expanded (**Error! Reference source not found.6-a** and **Error! Reference source not found.6-b**).

When calculating the β and γ angles, equation 3 and 4 can be used. θ_1 is input, θ_2 and θ_3 were calculated with Equation 1 **Error! Reference source not found.** and 2.

$$\beta = \cos^{-1}(\sin \theta_1 \cos \theta_2 \sin \theta_3 + \cos \theta_1 \cos \theta_3) \tag{3}$$

$$\gamma = -\sin^{-1}(\cos \theta_1 \cos \theta_2 \sin \theta_3 - \sin \theta_1 \cos \theta_3) \tag{4}$$

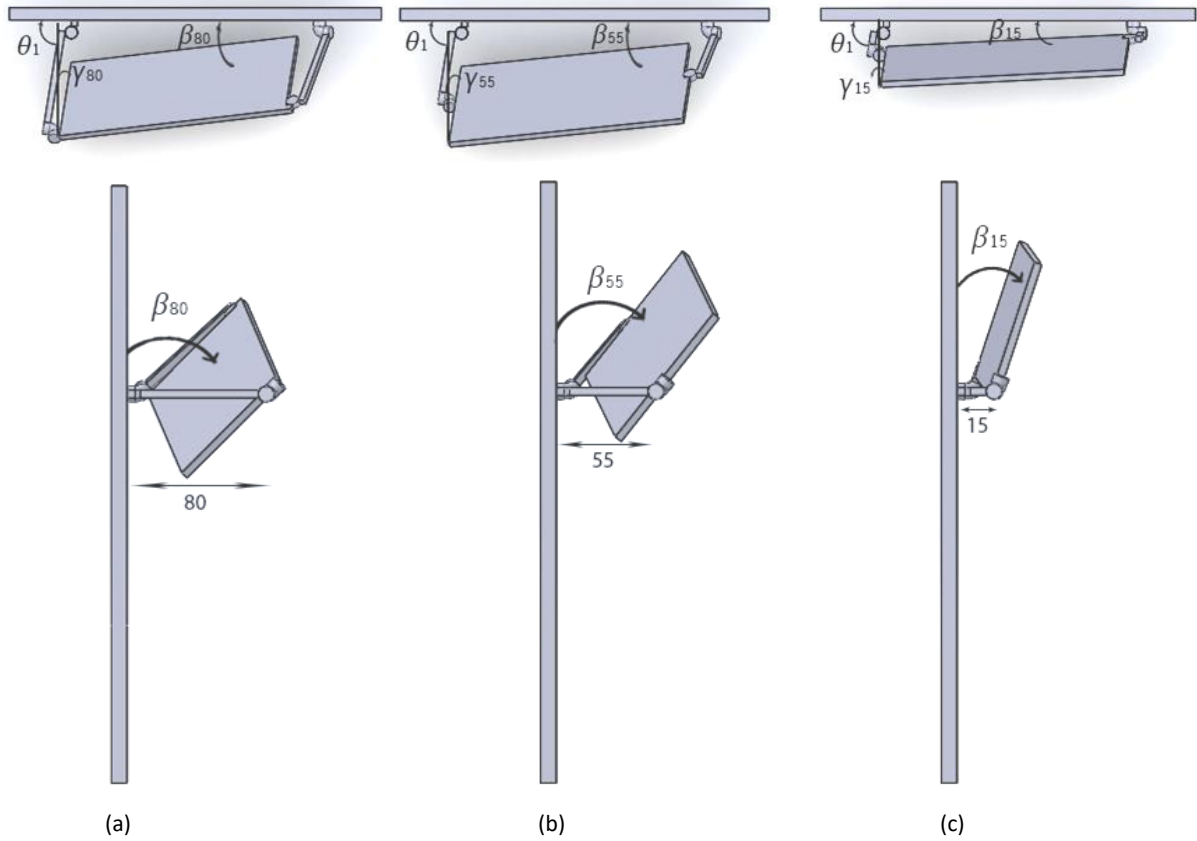

Figure 6. Three different alternatives of Altmann light shelf design

Error! Reference source not found. shows us a variation of Altmann light shelf which has different angles with the building (β) and with the west (γ). This table represents alteration of β and γ angles of three Altmann light shelves designed separately. The link a is constant (200 cm) and b is three different size (80, 55 and 15 cm). If the ratio between link length (a/b) is closed to 1, the rotation of Altmann light shelf represents more movements for using daylight efficiently.

Figure 717 shows the fluctuation between β and γ for each variation of the Altmann light shelf. Three different curves for each three different designed Altmann light shelf are shown. The blue curve is 15, the yellow curve is 55 and the orange curve is 80. Thanks to β and γ angles, the convenient Altmann light shelf can be designed. Because the west sun is significant for studying afternoon in the office room has the south facing window. Eventually, paying attention to the ratio between link length is significant for designing Altmann light shelf. **Error! Reference source not found.** supports to show the maximum angle of γ .

Table 3: The different variaton of Altmann light shelf

	b=80		b=55		b=15	
θ_1 (Input)	β_{80}	γ_{80}	β_{55}	γ_{55}	β_{15}	γ_{15}
90	90	0	90	0	90	0
80	43,37	15,53	37,13	11,89	17,28	3,99
70	30,43	16,56	24,76	12,39	9,73	3,88
60	22,64	15,45	17,90	11,49	6,49	3,57
50	17,09	13,47	13,27	10,03	4,59	3,13
40	12,74	11,07	9,78	8,27	3,29	2,61
30	9,09	8,43	6,92	6,33	2,28	2,02
20	5,86	5,68	4,44	4,27	1,45	1,37
10	2,88	2,85	2,17	2,15	0,70	0,69
0	0	0	0	0	0	0

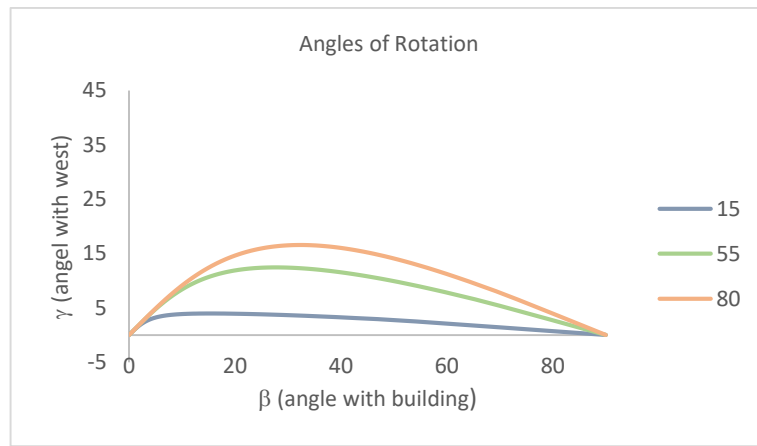

Figure 71. Diagram of the fluctuation between β and γ for each variation of Altmann light shelf.

Table 4: Maximum angle with west angle for three different design

	b= 80	b= 55	b= 15
Max angle of γ	16,60	12,46	4,00

As a result, the dimension especially the ratio of reciprocal links is notable designing an Altmann light shelf. As is observed in **Error! Reference source not found.** and Figure 71, the first one (80) is more suitable for light shelf because γ angle of the first one is higher than the others. Especially, when short link length increases, the west rotation angle increases. Also, according to Moazzeni and Ghiabaklou (2016), the optimum width of the light shelf must be 80-100 cm in their study. As is determined in **Error! Reference source not found.** and all calculation, the chosen Altmann light shelf must be 80 cm width and 200 cm length which has efficient motion for direct sunlight. The phase of this motion of $b=80$ is shown in **Error! Reference source not found.**.

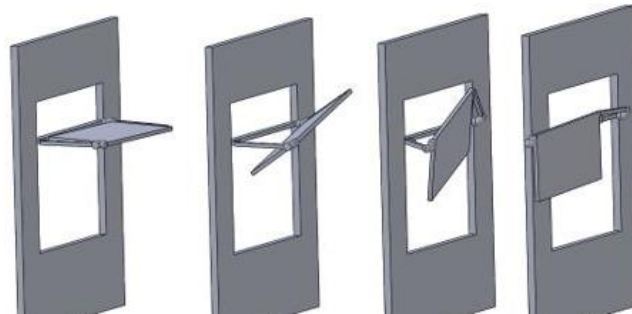

Figure 8. The Motion of the Altmann Light shelf $b= 80$

Result and Discussion

A geometric model of the case room and the external light shelf were created using Relux. The light shelf is designed to be analysed in three configurations which are shelf-less, plane light shelf and angulated (β is equal to 45°) light shelf. The calculation of these three configurations is assessed during the year or in a special time, based on annual weather information and changing conditions.

Error! Reference source not found. represents the results of average illuminance (E_{av}), minimum (E_{min}) and maximum (E_{max}) at four significant days (21st March, June, December and 23rd September) and at three hours (09:30, 12:30, 15:30) for each day. According to **Error! Reference source not found.**, average illuminance increases from 2580 lux to 2610 lux with the usage of plane configuration for 21 March 12:30 simulation result. While plane configuration increases 1,16%, angulated one decreases 1,16% average illumination level for the same date. For 23 September 12:30, this lapse-rate is happened 0% between shelf-less and plane configurations and angulated configuration decreases 2,79% average illumination level. With respect to these results, it is seen that Altmann light shelf contributes not only light directive panel but also using shading device for different seasons and timing (**Error! Reference source not found.**-**Error! Reference source not found.**).

Table 5: Illuminance calculation for South direction

Eav	21June			21March		
	Shelf-less	Plane	Angulated	Shelf-less	Plane	Angulated
09:30	222	257	196	569	632	561
12:30	378	395	342	2580	2610	2550
15:30	332	388	305	566	528	623
Emin						
09:30	107	129	94	158	179	130
12:30	178	187	160	227	278	221
15:30	148	189	150	164	172	162
Emax						
09:30	340	378	305	3050	3240	2780
12:30	600	637	553	36200	36300	36100
15:30	556	621	486	2820	2430	3560
Eav	21Dec			23Sept		
	Shelf-less	Plane	Angulated	Shelf-less	Plane	Angulated
09:30	1300	1340	1360	387	381	437
12:30	4280	4020	4120	1840	1840	1790
15:30	1370	1360	1270	823	936	848
Emin						
09:30	236	240	238	123	129	115
12:30	542	451	448	218	241	192
15:30	259	247	211	200	216	194
Emax						
09:30	4660	4790	4840	1060	839	1700
12:30	29400	29100	29300	34900	35000	3490
15:30	4690	4720	4370	28200	29300	28900

Table 6: Three different configurations in Summer



Summer	Shelf-less	Plane	Angulated
09:30			
12:30			
15:30			
Summer	Shelf-less	Plane	Angulated
09:30			
12:30			
15:30			

Table 7: Three different configurations in Winter





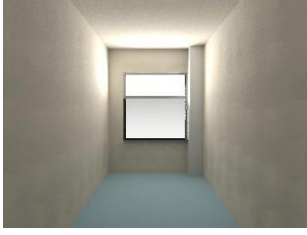
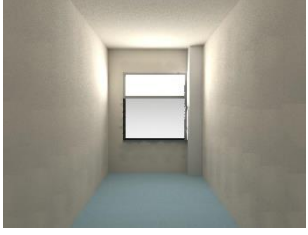
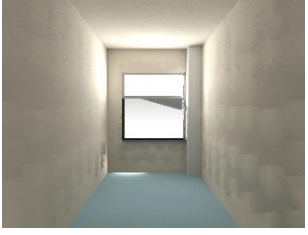
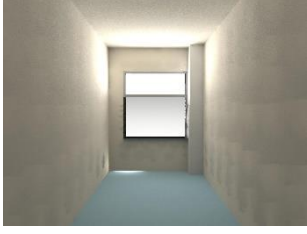
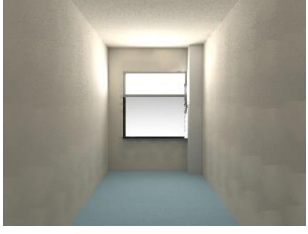
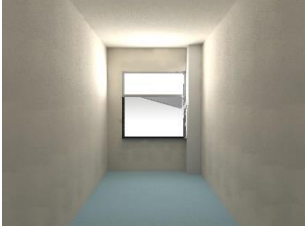

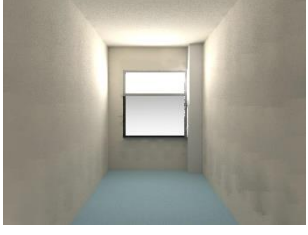
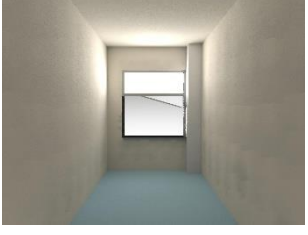
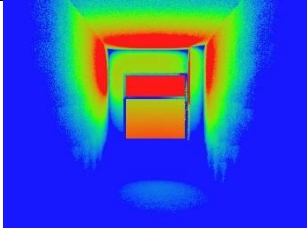
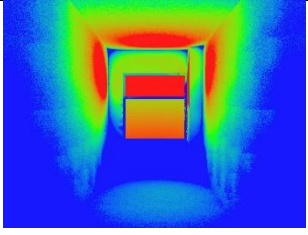
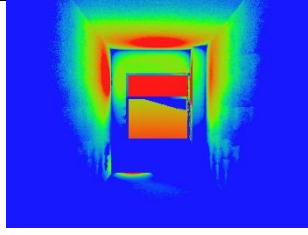
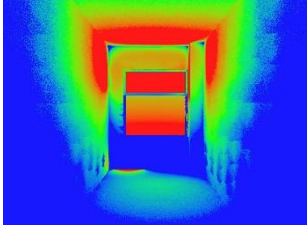
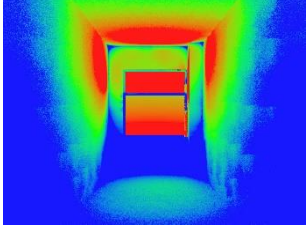
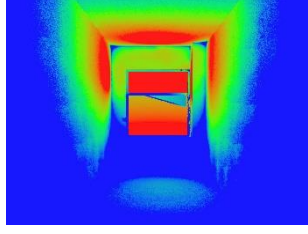
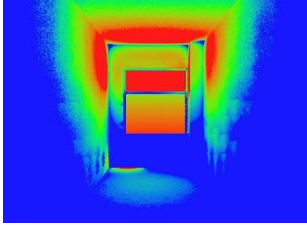
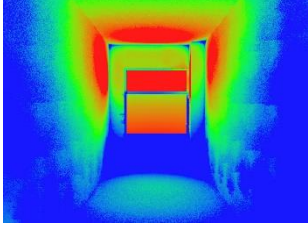
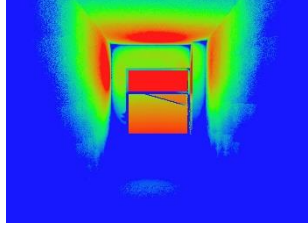

Winter	Shelf-less	Plane	Angulated
09:30			
12:30			
15:30			
Winter	Shelf-less	Plane	Angulated
09:30			
12:30			
15:30			

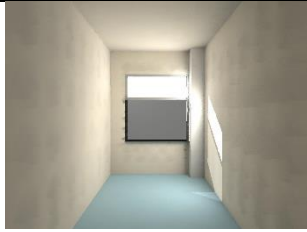
Table 8: Three different configurations in Spring

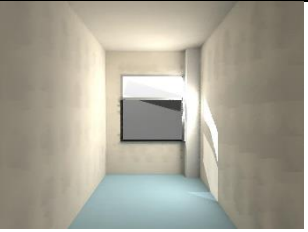



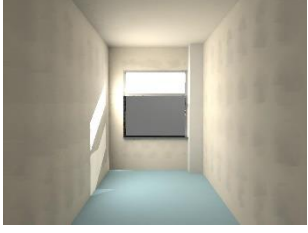

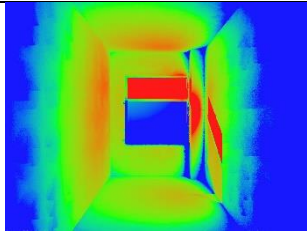
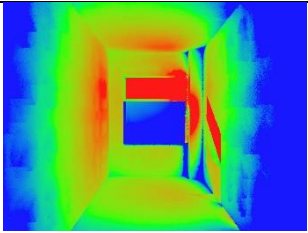
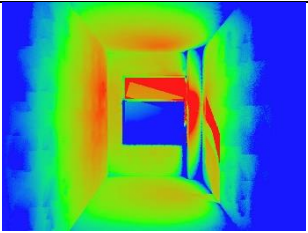
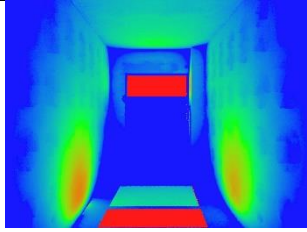
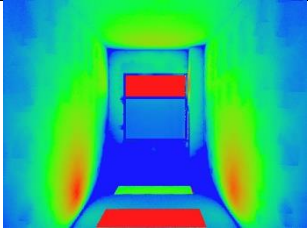
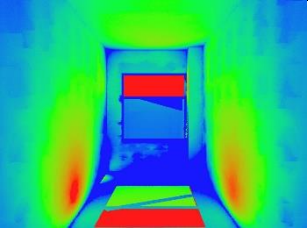
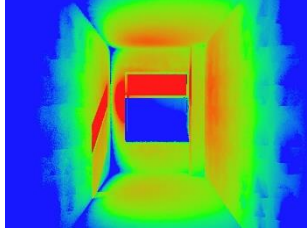
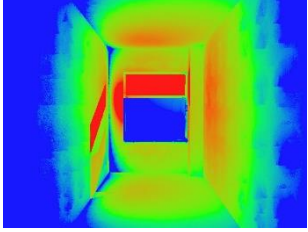
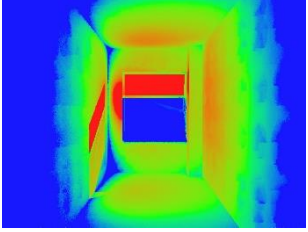

Spring	Shelf-less	Plane	Angulated
09:30			
12:30			
15:30			
Spring	Shelf-less	Plane	Angulated
09:30			
12:30			
15:30			

Table 9: Three different configurations in Autumn

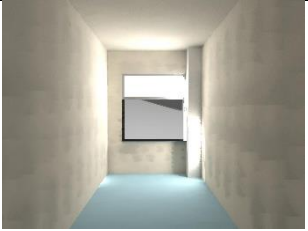
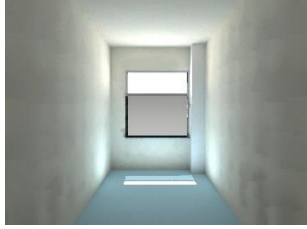
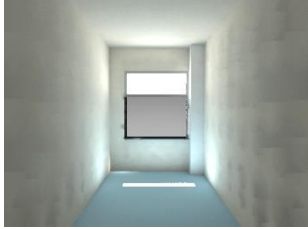
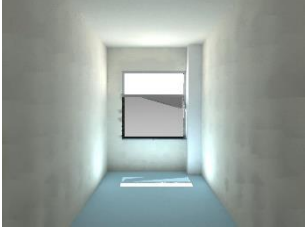
Autumn	Shelf-less	Plane	Angulated
09:30			
12:30			
15:30			
Autumn	Shelf-less	Plane	Angulated
09:30			
12:30			
15:30			

While **Error! Reference source not found.** and **Error! Reference source not found.** present sDA (Spatial Daylight Autonomy) values of three different configurations, **Error! Reference source not found.** and **Error! Reference source not found.** represent ASE (Annual Sunlight Exposure). These values represent that angulated configuration is using as a shading device at 9:30 in summer and in winter, all configurations have the same values at 12:30. The light shelf can convert from plane to angulated in Autumn.

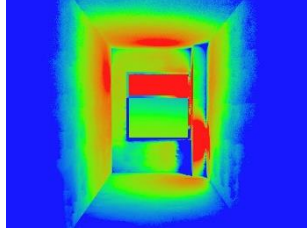
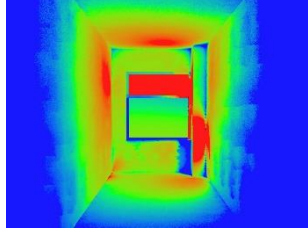
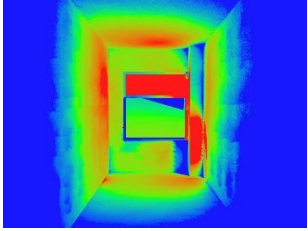
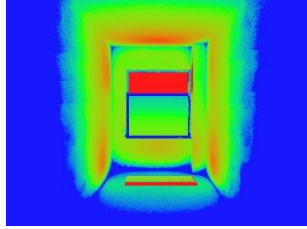
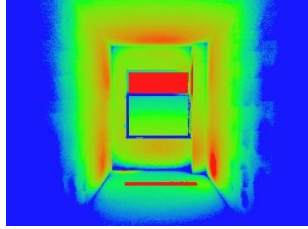
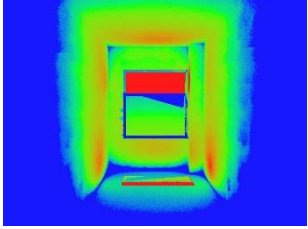
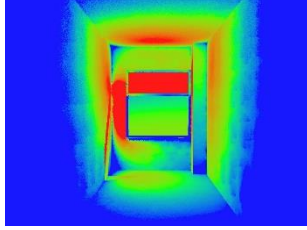
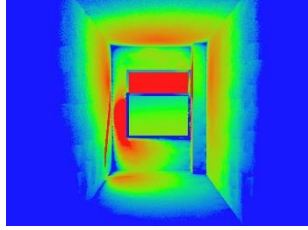
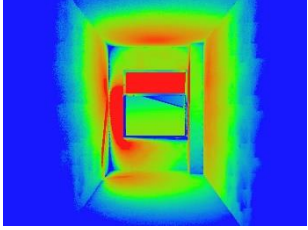
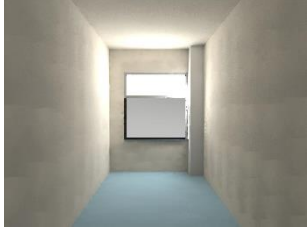
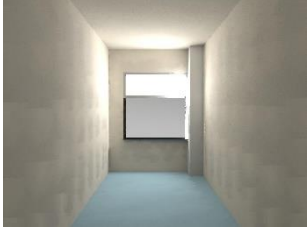
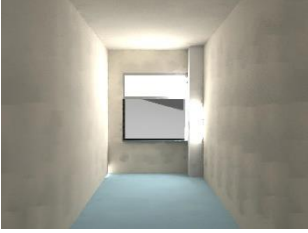
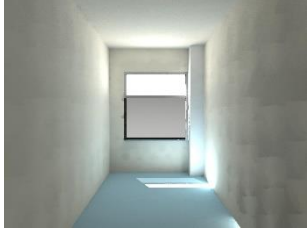
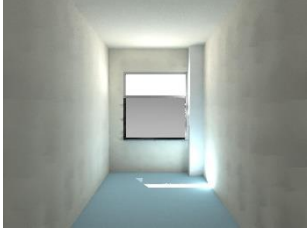
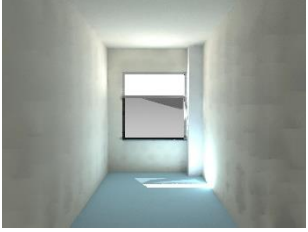
Table 10: sDA values of three version

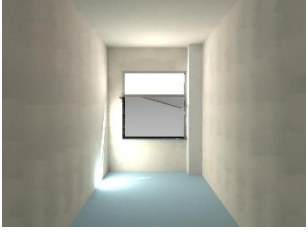
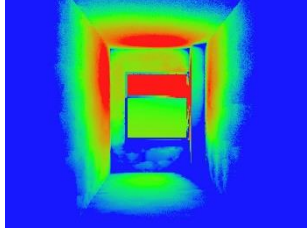
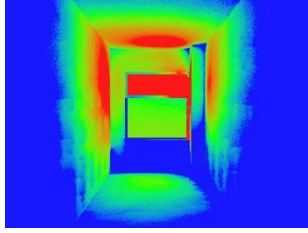
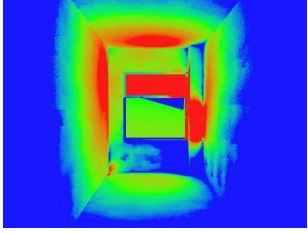
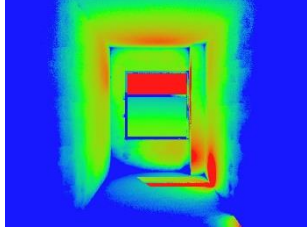
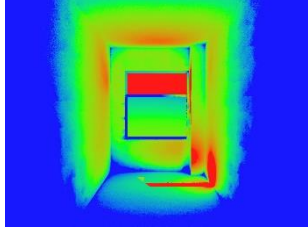
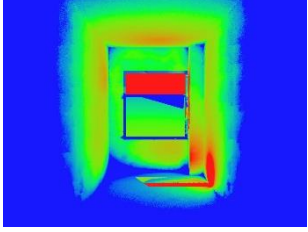
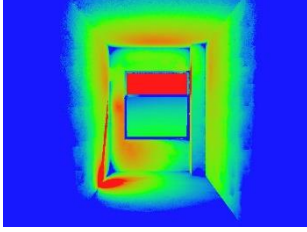
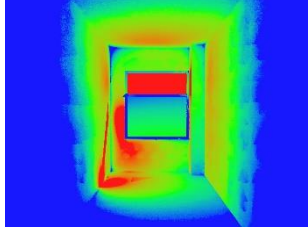
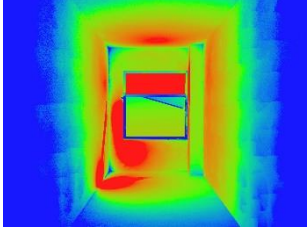
		Shelf-less	Plane	Angulated
Summer	09:30	29,09	41,81	9,09
	12:30	56,36	63,63	58,18
	15:30	54,54	63,63	49,09
Winter	09:30	85,45	87,27	85,45
	12:30	100	100	100
	15:30	90,90	90,90	83,63
Spring	09:30	60	67,27	61,81
	12:30	74,54	89,09	80
	15:30	61,81	69,09	63,63
Autumn	09:30	45,45	54,54	45,45
	12:30	76,36	81,81	70,90
	15:30	74,54	76,36	67,27

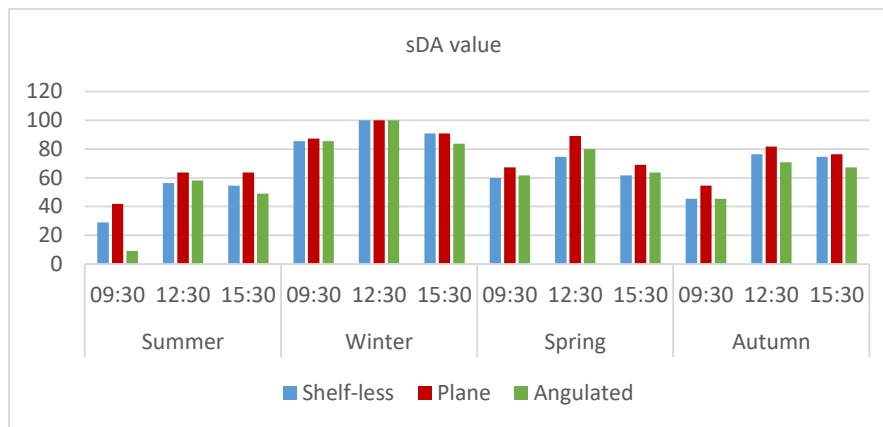

Figure 9. sDA values of three cases for each season

Table 11: ASE values of three version

		Shelf-less	Plane	Angulated
Summer	09:30	0	0	0
	12:30	0	0	0
	15:30	0	0	0
Winter	09:30	43,63	45,45	45,45
	12:30	58,18	27,27	40
	15:30	45,45	45,45	43,63
Spring	09:30	14,54	10,90	9,09
	12:30	9,09	12,72	9,09
	15:30	9,09	9,09	9,09
Autumn	09:30	1,81	0	7,27
	12:30	7,27	5,45	6,36
	15:30	5,45	18,18	3,63

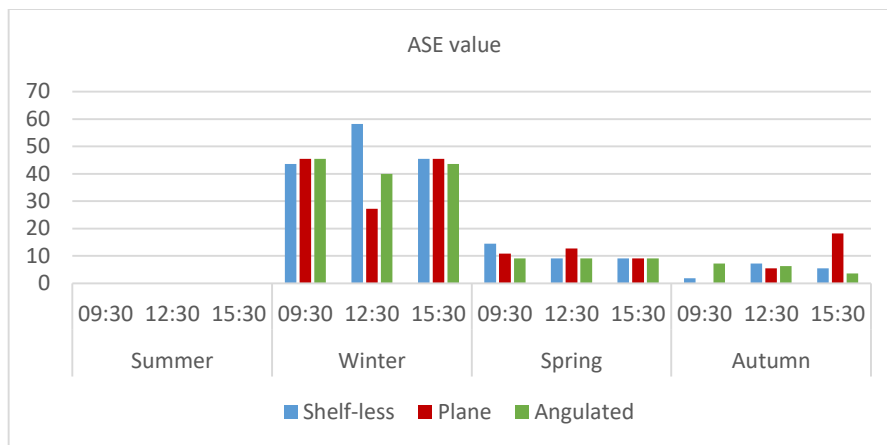

Figure 10. ASE values of three cases for each season

Error! Reference source not found. shows annually sDA and ASE values. While sDA of plane configuration is 73,78%, the value of 45° angle configuration is 64,54%. Occurring sun patch, ASE of plane configuration is higher than 45° angle configuration. Because ASE value of 45° angle is 14,47% otherwise; the value of plane configuration is 14,54%.

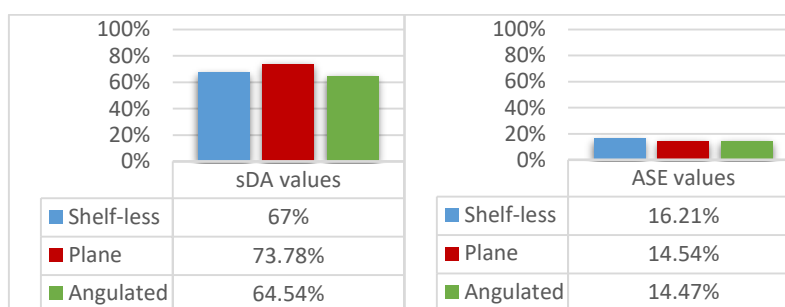

Figure 11. Annually sDA and ASE values

Conclusion

Light shelves are known to be stable or movable through x and y-directions. The Altmann light shelf is a linkage whose diagonal movement changes. In previous study (2017), the daylight system consists of 9 square light shelves but now, this study includes a rectangular light shelf. Thanks to this design difference, sun patch formation is minimized. Previous study shows that the sDA and ASE values of 45° angle configuration and plane configuration are similar but 45° angle configuration is better in Summer noon and Spring morning.

In this study, three different light shelf design indicates when designing movable light shelf, the daylight orientation angle is more significant to use the daylight more efficiently. Thanks to geometric properties of Altmann linkage, it presents that many different light shelves are designed just changing dimension of two reciprocal links. Three different sizes of light shelves which have two link size two of them are stable (link a) and two of them are variable link length (link b = 15/55/80) are used in this study, considering the optimum dimensions of the light shelf. All calculations illustrate that it needs to use b=80 because the ratio between link length (a/b) is more closed to 1 because it rotates more movement for using daylight efficiently. After that, selected light shelf is analysed daylight performance in Relux. The light shelf is designed three different configurations for analyzing which are shelf-less, plane light shelf and angulated (β is equal to 45°) light shelf. Illuminance values and uniformity of three different configurations are calculated at four significant dates (two equinox and two solstice) and three chosen hours (09:30, 12:30, 15:30) for each one. Then, sDA and ASE values are calculated for each configurations to understand which one is more efficient. All results show that although the values of plane and angulated configuration look like the same, angulated configuration is more efficient in winter.

References

- Freewan, A. A. (2010). Maximizing the light shelf performance by interaction between Light shelf geometries and a curved ceiling. *Energy Conversion and Management*, 51, 1600–1604.
- Soler, A. & Oteiza, P. (1997). Light Shelf Performance in Madrid, Spain. *Building and Environment*, 32(2), 87-93.
- Soler, A. & Oteiza, P. (1996). Dependence on solar elevation of the performance of a light shelf as a potential daylighting device. *Renew Energy*, 8, 198-201.
- Claros, S.T. & Soler, A. (2002). Indoor daylight climate – influence of light shelf and model reflectance on light shelf performance in Madrid for hours with unit sunshine fraction. *Building and Environment*, 37(5), 87-98.
- Beltran, L.O., Lee, E.S., & Selkowitz, S.E. (1997). Optical daylighting systems: light shelves and light pipes. *Illuminating Engineering Society*, 20, 91-106.

6. Kurtay, C. & Esen, O. (2017). A new method for light shelf design according to latitudes: CUN-OKAY light shelf curves. *Journal of Building Engineering*, 10 (2017), 140-148.
7. Lee, H. (2019). Performance evaluation of a light shelf with a solar module based on the solar module attachment area. *Building and Environment*, 159(2019), 106161.
8. Chan, Y.C. & Tzempelikos, A. (2015). Daylighting and energy analysis of multi-sectional facades. *6th International Building Physics Conference* (p. 189-194).
9. Lee, H., Gim, S., Seo, J., & Kim, Y. (2016). Study on movable light-shelf system with location-awareness technology for lighting energy saving. *Indoor and Built Environment*, 0(0), 1-17.
10. Atarer, F., Kazanasmaz, T. and Korkmaz, K. (2017). "Design of A Light Shelf with the Altmann Linkage." In *Interdisciplinary Perspectives For Future Building Envelopes*, 14–24. İstanbul: ICBEST.
11. Altmann, F.G. (1954). Über räumliche sechsgliedrige Koppelgetriebe, *Sonderdruck aus der Zeitschrift des Vereines Deutscher Ingenieure*, 96(8), 245–249.
12. Baker, J. E. (1993). A Geometrico-Algebraic Exploration of Altmann's Linkage *Mech. Mach. Theory*, 28 (2):249–260.
13. Moazzeni, M.H. & Ghiabaklou, Z. Investigating the Influence of Light Shelf Geometry Parameters on Daylight Performance and Visual Comfort, a Case Study of Educational Space in Tehran, Iran. *Buildings* 2016, 6, 26; doi:10.3390/buildings6030026