



Hybrid-Model Simulations to Equilibrate Energy Demand and Daylight Autonomy as a Function of Window-to-Wall Ratio and Orientation For a Perimeter Office in Izmir

İzmir’de Tek Hacimli Bir Ofisin Enerji Yükü ve Gün Işığı Otonomisini Dengelemek İçin Pencere-Duvar Oranı ve Yönelimine Bağlı Olarak Gerçekleştirilen Hibrit-Model Simülasyonları

Hakan BAŞ,¹ Tuğçe KAZANASMAZ²

ABSTRACT

This study is based on integrated thermal-lighting simulations to find the optimal value of the window-to-wall ratio (WWR) for a perimeter, single-zone office to equilibrate daylight autonomy and overall energy demand in the climate of Izmir, Turkey. A hybrid model approach has been adopted that combines thermal and lighting calculations in a single model via the IES <VE> software. The optimal WWRs to achieve the highest possible daylight benefit and lowest overall energy use at the same time has been found to have 30% WWR in the South and West, 40% WWR in the East and 60% WWR in the North. These WWR values trade-off daylight benefit, total energy consumption for lighting, heating, and cooling, and visual comfort compared to larger and smaller WWR options. Since the daylight use can significantly reduce artificial lighting energy consumption as long as WWR increases, the energy benefit from lighting reaches 79% as a function of daylight for the South case at 30% optimal WWR. The strongest effect of cooling demand is evident in the breakdown of energy consumption and the amount of glazing is the dominant factor defining the cooling demand. The implications of this study can help architects get feedback on how to save energy for each final energy use (heating, cooling, and lighting) reduction in window space and convey this message to their designs with suggested optimal WWR values.

Keywords: Daylight autonomy; daylighting; energy use; visual comfort; window-to-wall ratio.

ÖZ

Bu çalışma, İzmir iline ait iklim koşulları bağlamında tek hacimli bir ofisin gün ışığı otonomisini ve toplam enerji yükünü dengelemek için optimum pencere-duvar oranını (PDO) bulmak için yapılan entegre termal-aydınlatma simülasyonlarına dayanmaktadır. IES<VE> yazılımıyla termal ve aydınlatma hesaplarını bir modelde birleştiren "hibrit model" yaklaşımı benimsenmiştir. Olası en yüksek gün ışığı faydası ve en düşük toplam enerji tüketimini sağlamak için en uygun pencere-duvar oranı değerleri sırasıyla güney ve batıda %30, doğuda %40 ve kuzeyde %60 olarak bulunmuştur. Bulunan pencere-duvar oranı değerleri gün ışığından yararlanmayı ve görsel konforu sağlarken, aydınlatma, ısıtma ve soğutma için genel enerji tüketimini daha büyük ve daha küçük pencere-duvar oranı alternatiflerine göre daha iyi dengelemektedir. Pencere-duvar oranı arttığında artan gün ışığı miktarı, yapay aydınlatma enerji tüketimini önemli ölçüde azaltmakta ve aydınlatma enerjisi kazancı, güney cephede optimum %30 pencere-duvar oranı için %79'a kadar ulaşmaktadır. Enerji tüketimi analizinde soğutma talebinin güçlü etkisi açıkça görülmektedir ve pencere alanı soğutma talebini belirleyen en önemli etkidir. Bu çalışmada ortaya çıkan sonuçlar, pencere alanındaki azalmanın her bir enerji kullanımında (ısıtma, soğutma ve aydınlatma) ne kadar enerji tasarrufu sağladığına dair mimarların geri bildirim almalarına ve önerilen optimum pencere-duvar oranı değerlerinin tasarıma aktarılmasına yardım etmektedir.

Anahtar sözcükler: Gün ışığı otonomisi; doğal aydınlatma; enerji kullanımı; görsel konfor; pencere-duvar oranı.

¹Department of Architecture, İzmir Katip Çelebi University Faculty of Faculty of Engineering and Architecture, İzmir, Turkey

²Department of Architecture, İzmir Institute of Technology Faculty of Architecture, İzmir, Turkey

Article arrival date: June 20, 2019 - Accepted for publication: August 27, 2020

Correspondence: Hakan BAŞ. e-mail: hakanbash@hotmail.com

© 2020 Yıldız Teknik Üniversitesi Mimarlık Fakültesi - © 2020 Yıldız Technical University, Faculty of Architecture

Introduction

While office buildings account for 19% of global lighting energy consumption by commercial-building type (IEA, 2006), lighting comprises 30% to 40% of total energy consumption in office buildings (Halonen et al., 2010). The common trend for designing low-energy office buildings is to reduce electricity for illumination using light sources with high luminous efficiency and minimum power density along with lighting control systems. Daylight is also integrated to this.

Compared to electrical light sources, there are many useful aspects of using daylight in buildings. It is regarded as a more efficient light source as it provides more “lumens per unit of heat content” (Heschong, 2002, p. 65) compared to lamps and luminaries. It reduces dependence on electrical lighting, while creating a sense of “cheeriness and brightness” (Li et al., 2006, p. 1343) and improves visual comfort conditions that provide health and productivity benefits for office workers (Nabil, 2006). The joint contribution of electrical lighting and window design is a major determinant of energy requirements related to thermal energy performance in office buildings. Using daylight effectively, the excess use of electrical lighting and the need for cooling loads can be reduced, respectively as the heat generated from the electrical light sources and the high solar heat gain from direct sunlight can be reduced. In this context, there is a strong and complex interaction between the windows’ WWR, its thermal/optical characteristics and its total energy performance. This relationship also depends on climate and orientation (Clarke et al., 1998; IEA, 2006; Meresi, 2016).

There is a growing tendency to design fully glazed offices from architectural and aesthetic concerns. However, an increase in the glazed area, without any proper shading, will lead to some contradictory effects, i.e. positive effects such as solar heat gain, view; and negative ones such as thermal and visual discomfort (Clarke et al., 1998). The integrated design approach balances these constructive and undesirable effects of windows and ensures optimal energy equilibrium (CIBSE Lighting Guide, 1999; Fasi & Budaiwi, 2015). To achieve this, it is inevitable to generate a numerical model following an integrated thermal-daylighting design approach to accurately measure the implementation of daylight impact on the energy equation. As a result, special attention should be paid to the window design. Despite the tendency to increase the window space for external visual contact, or to promote daylight, it is essential to find the best possible solution measured by the the window-to-wall ratio (WWR) indicator (Kazanasmaz et al., 2016). WWR is defined as “the ratio of the total area of windows to the overall gross external wall area (including windows)” (Li et al.,

2006, p. 1344). Although the thermo-physical properties of windows, shading devices, control systems, window width, ratio of window height to floor area and room geometry significantly affect daylight availability (Standard DIN, 1994; Freewan, 2015), WWR has been found to be the most critical direct parameter in establishing a link between daylighting and the thermal performance of a perimeter space (Tzempelikos & Athienitis, 2005, 2006, 2007). Such integration of daylighting and thermal performance provides an opportunity to control the accuracy of the WWR controlled in both in the daylight availability and in the breakdown of total energy consumption. Hence, the research questions are as follows:

1. What are the ideal alternatives to WWR in terms of the *lowest* energy consumption (heating, cooling and lighting), *preferred* daylight autonomy, and individually *preferred* visual comfort for the South, North, East and West orientation?
2. What is the optimal value of WWR using *low* energy for heating, cooling, and lighting as well as providing the *acceptable* daylight autonomy and *satisfactory* visual comfort in a perimeter office?
3. How do WWR values and energy end-uses vary according to façade orientation?

Various studies concerning the WWR have been analyzed in the literature in terms of daylighting and thermal performance of office buildings. (Reinhart, 2002; Melendo & Roche 2009; Reinhart et al., 2014; Chen & Yang, 2015; Mangkuto et al., 2016). Tzempelikos and Athienitis (2007) showed that a 30% window-to-wall ratio for south-facing facades in Montreal (continental climate) provides 500 lx daylight illumination on the work plane and 76% of working time within a year and, that any rise in WWR does not provide additional daylight benefits, but results in glare and overheating risks. Poirazis and Blomsterberg (2005) stated that 60% and 30 % WWRs led to similar total energy use lower than the energy consumed when 100% WWR is applied in an office building in Sweden (ocean climate). The optimal WWR for heating, cooling, and lighting was found to be 80%, 10% and 40% respectively in Iran’s hot and dry climate zone, and maintained the best performance solution in total primary energy consumption without using any shading devices, keeping the WWR at 50% (Nasrollahi, 2010).

Other studies were conducted comparatively (Inanici&Demirbilek, 2000; Özkan& Onan, 2011; Yildiz et al., 2011; Bostancioglu&Telatar 2013; Leonidaki et al., 2014; Goia 2016) to evaluate the climate and location impact on optimal WWR in different cities. Leonidaki et al. (2014) conducted thermal simulations to identify optimal WWR and thermal mass in Thessaloniki, Greece, and Nicosia, Cyprus (Mediterranean climate) and London, United

Kingdom, and Munich, Germany (Oceanic climate). The study compares the 25%, 50% and 75% WWRs in different climate zones and cities. In terms of heating energy consumption in the Mediterranean climate, the best-case scenario is 75% WWR, however, given the cooling energy consumption, 25% WWR is better. In this study, the best performance solution for overall energy consumption was found to keep the WWR as low as possible by minimizing thermal heat losses regardless of climate.

Regarding WWR, only lighting energy savings were quantified in the London climate; WWR's were suggested for distances ranging from 10 % to %40 for each location, orientation and window distance (Acosta et al., 2016). The study by Berardi and Anaraki (2018) reveals that an application of a daylight redirecting system i.e. a light shelf, with a WWR above 25% increases daylight illumination at the back side of the room, while a WWR of over 35% does not change the conditions much.

A wide range of studies has been carried out to find the optimum WWR in buildings in different climate zones of Turkey. Yılmaz, Y., and Yılmaz, B. Ç. (2020) conducted a study to optimize the window size in terms of energy, thermal comfort and daylight performances in Istanbul representing the temperate-humid climate zone. They found that the optimized window sizes for the North, South, West and East facades were 29.47%, 35.06%, 15.99%, and 19.18% WWRs, respectively. Ünlü (2018) investigated WWR options between %5 and % 95 to minimize energy use and maximize the level of daylight illumination options in four different climate zone of Turkey. He found that the optimal WWR varied between 0.10 to 0.35 for the North, 0.10 to 0.15 for the East, 0.10 to 0.20 for the South and 0.10 for the West in the Izmir climate.

In addition to the hypothetical approach, some fieldwork were carried out to find the impact of WWR on the energy consumption and daylight level of existing buildings in Izmir. Bayram (2015) conducted a fieldwork in an educational building to find the optimal values of the window- wall ratio, shading devices, surface colors and lighting fixture types in terms of daylighting, visual comfort and energy consumption and stated that sufficient WWR is needed to ensure adequate daylight levels. Öner (2020) carried out a fieldwork investigating the impact values of design parameters such as window-wall ratio, wall-to- floor ratio, window- to-floor ratio, total building area, wall- to- volume ratio, settlement pattern and plan type in existing 19th century Izmir Houses and stated that WWR is very effective in the energy performance of 19th century Izmir houses.

Although such studies on WWR are found in the literature, each case represents a variety of building characteristics/geometry, climate, location, mechanical/

natural ventilation, even daylight/thermal control systems, and combined energy strategies etc. They used various simulation tools/techniques or methodologies. Unlike the previously mentioned studies, this study relates to daylight autonomy and visual discomfort along with overall energy performance for heating, cooling and lighting to find optimal WWR with the help of climate-based and *hybrid model* approach.

Thus, this study aims primarily to achieve the optimum WWR value for office spaces in Izmir, which will ensure the lowest overall energy consumption while aiming at the best daylight autonomy without neglecting visual discomfort. The method includes a *hybrid model* as explained in the following section. The findings of this demonstration are expected to deliver a useful message and feedback to designers to achieve the best possible lighting and primary energy performance for office design in Izmir.

Method

The method of this theoretical study is based on simulations. There are two different approaches to the problem of daylight and thermal energy in simulations. The *single model* approach performs daylight, thermal and energy simulations without taking electric lighting into account. Nevertheless, the *hybrid model* approach takes daylight and thermal effects into account in two independent models (Jakubiec, 2011, p. 2202). In this study, since electric lighting is a significant factor in the energy consumption of an office building, the *hybrid model* approach was adopted by combining hourly permanent lighting and thermal simulations.

To achieve a *hybrid model* approach through simulations, IES <VE> (Integrated Environmental Solutions-Virtual Environment) software is used because of its user-friendly graphical user interface and template-oriented approach that facilitates to attain fast and accurate results (Attia et al., 2009). IES <VE> is one of the main programs whose validation is widely reported. It has been validated and recognized by the BESTEST Standard of International Energy Agency (2006) and also achieved a high score in the comparative study of the capacity of twenty building energy simulation programs conducted by Crawley et al. (2005).

IES <VE> is a complete building energy performance modeling software that can simulate hour by hour, time-varying thermal and daylighting using a realistic weather file. Integrated daylighting and thermal simulations in IES <VE> were carried out with Model-IT 3-D modeling module, ApacheSim thermal simulation engine, FlucsPro electrical and daylighting design section and RadianceIES Climate Based Daylight Modelling (CBDM) section. ApacheSim is a thermal simulation engine that

models dynamic interactions between the building and the outdoor climate taking into account internal loads and building HVAC systems. FlucsPro is a module that performs both lighting design and analysis calculations based on CIBSE methods. It can automatically design light-fitting layouts with sufficient Light Power Density (LPD). RadianceIES is based on a *backward ray-tracing* algorithm program and provides the design of an optimal lighting system that accounts for both natural and artificial light. It allows the impact of the electrical light dimming system on total energy consumption to be calculated as a function of daylight level by connecting to the thermal simulation engine ApacheSim,. It also provides Climate Based Daylight Modeling (CBDM) technology that uses standardized climate data to estimate any luminous quantity by using realistic sky conditions. It is, therefore, more realistic as it provides time-varying sky and sun conditions and hourly results.

Daylight Metrics and CBDM

Daylight metrics are used to quantify daylight availability in spaces. One of the well-known and widely applied daylight metrics to calculate daylight sufficiency is the daylight factor (DF) (Nabil & Mardaljevic, 2005). Daylight factor (DF) is the ratio of horizontal illumination from the interior under standard CIE cloudy sky conditions. However, it is not a completely reliable metrics because it does not consider the effect of the sun and ignores the daylight produced in clear skies and partly cloudy conditions (Boyce et al., 2014). At the same time, daylight assessment with DF is static, and results are based on *a single point in time* calculations in a relatively short period.

To overcome the disadvantages of the DF approach, the IES Daylight Metrics Committee introduced a new climate-based IES Approved metrics (LM, 2013) called Spatial Daylight Autonomy (SDA), based on a climate-based method that provides a time-varying sky and solar conditions as opposed to the conventional daylight factor approach. The sDA is a metric to predict daylight sufficiency, reports how the percentage of the floor area of a given space exceeds the required illumination during a particular analysis period. If the required illuminance is 500 lx for a given space, hourly illumination values above 500 lx can be contributed to calculations. sDA consists of two threshold values. First, the preferred value $sDA_{500,50\%} \geq 75\%$ of the analysis area means that sDA provides a 500 lx daylight level in 50 % hours of total time in 75% of the analysis area. The second is a *nominally acceptable* threshold value, $sDA_{500,50\%} \geq 55\%$ of the analysis area. These threshold values and performance criteria are derived from site measurement and field research (LM, 2013). However, there is no upper limit for calculating excessive daylight levels and sunlight penetration in the sDa. The IES

Daylight Metrics Committee has developed a new metric called Annual Sunlight Exposure (ASE) to calculate the potential visual discomfort and probability of glare caused by direct sunlight. ASE reports how the percentage of the floor area of the space exceeds a certain direct sunlight illumination. It uses 1000 lx as the threshold value for sunlight and is allowed no more than 1000 lx daylight not to exceed 250 hours a year and calculates the percentage of analysis points that receive 1000lx more than 250 hours per year. ASE consists of two threshold values. The *preferred* threshold written using the subscript $ASE_{1000,250h} < 3\%$ of the analysis area and the *nominally acceptable* threshold is $ASE_{1000,250h} < 7\%$ of the analysis area. More than 10% of the analysis area for $ASE_{1000,250h}$ is considered an *unsatisfactory* threshold (LM, 2013).

According to the CEC PIER Daylight Metrics Research Project which has a total of 61 workspaces in three types of sites, such as classroom, office and library, the Spatial Daylight Autonomy (sDA) and Annual Sunlight Exposure (ASE) were found to best correlate with occupant assessments (LM, 2013). These two new climate-based daylight metrics are found in the RadianceIES module in IES <VE>. However, sDA cannot measure potential visual discomfort as it does not have a maximum threshold value for daylight illumination, and ASE does not evaluate daylight sufficiency separately. This study, therefore, uses both sDA and ASE metrics to assess the target illuminance of daylight as well as taking into account visual discomfort as a function of WWR. It is significant to assess that the results are valid during occupancy hours.

Climatic Conditions

The study was conducted in Izmir located at 38.42°N latitude and 27.14°E longitude. The climate of Izmir shows the characteristic features of a typical Mediterranean climate labeled with CSa in the Köppen climate classification. The city mostly experiences hot/dry summers and wet/warm winters. July is the hottest month with an average maximum temperature of 33.2 °C and January is the coldest month with an average minimum temperature of 5.9 °C. July is the sunniest month with 12.2 hours of sunshine per day whereas December is the coldest with 4.1 hours. Izmir has the potential for an average of 2886 hours per year of intense daylight during the day according to the database between 1938 and 2017 of the Turkish State Meteorological Service. Izmir is also categorized in ASHRAE Climate as Zone 3 and Aplocate tool, the weather and site location editor of IES <VE> uses ASHRAE Design Weather Database v5.0.

Description of the Reference Office Model

The reference single perimeter test office proposed by Van DIJK & Platzer (2003) is used for simulations (Fig. 1-2).

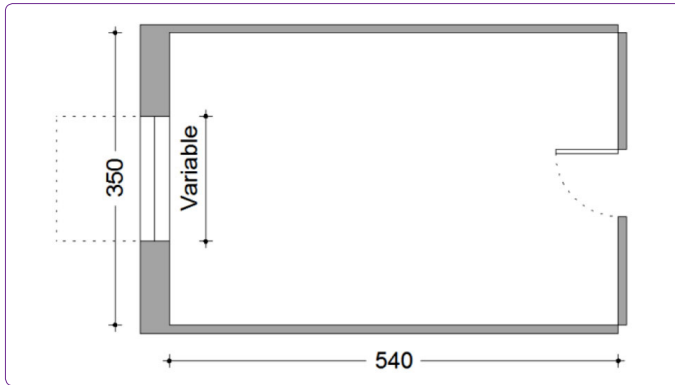

Figure 1. Plan view of reference test office room.

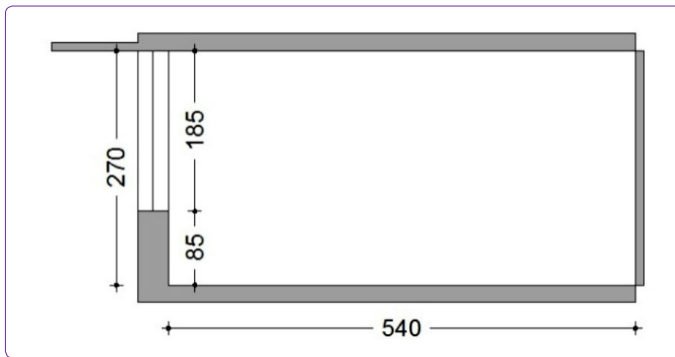

Figure 2. Longitudinal section of reference test office room.

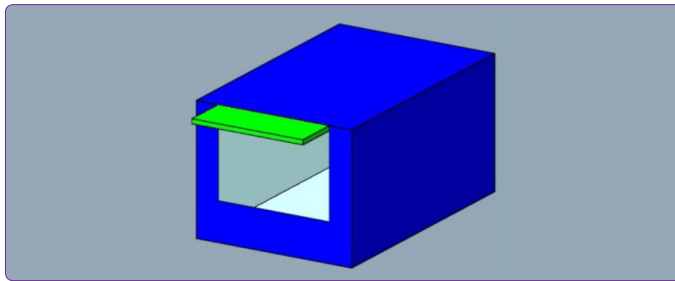

Figure 3. 3-D Model obtained from Model-IT tools of IES <VE>.

The test office room is a sub-office with only an external wall. The office is 5.4 m depth, 3.5 m long and 2.7 m high and has a floor area of 18,9 m². The office for calculation is modeled using the Model-IT tools of IES <VE> (Fig. 3).

To increase the window width from 50 cm to 350 cm, a total of 7 WWR alternatives was generated from 10% to 70% of WWR (Fig. 4). Window height (1.85 m) was set to be fixed. The window sill is located at a height of 85 cm above the ground. This level is equal to the height of the reference working plane when additional glazing below the height of the working plane does not contribute to the required illumination but affects the thermal energy load.

Lighting Calculations

In WWR optimization work, the interaction between daylight and artificial light is important due to these are in a complementary relationship to provide necessary illumination. Still, it is hard to estimate the energy savings from an electrical light dimming system. In this study, automatic electrical lighting control is presented by using a “continuous dimming system” in response to the level of daylight in which the continuous dimming system in the offices minimizes the employee’s distraction by switching the electrical lights. A dimming sensor grid consisting of 6 sensors was generated on working plane to measure the illumination value (Fig. 5). The daylight control sensors were placed on the ceiling in accordance with the workplace positioning (Fig. 6). The sensors are connected to fluorescent lamp fixture on the ceiling at 2.7 m, detect the illumination value from the working plane and modulation of the light flux from the luminaries. The illuminance level of 500 lx required for general office work was selected (IESNA Lighting Handbook, 2000). If the lights were on during working hours and if daylighting provides

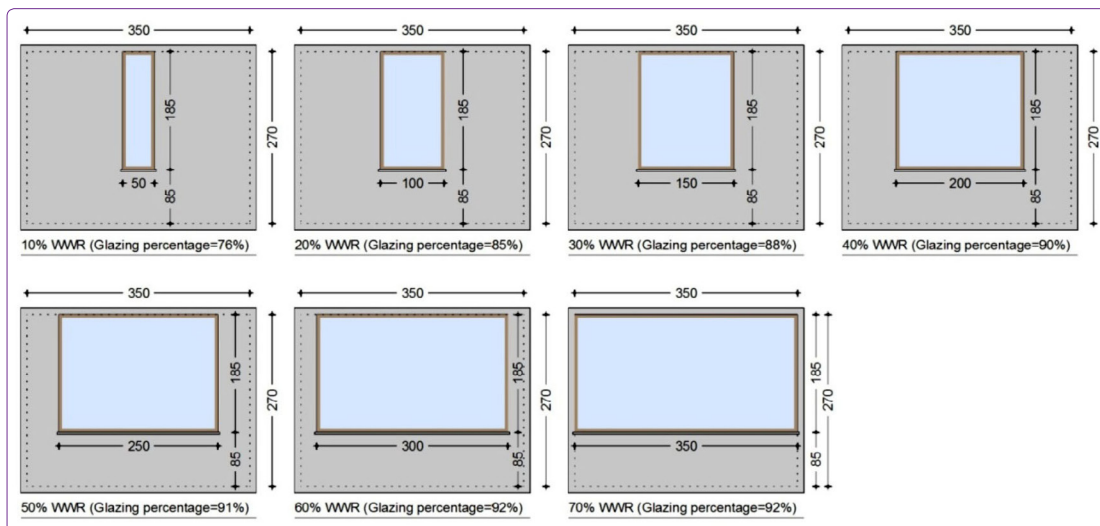

Figure 4. Façade view of WWR options.

less than 500 lx, artificial lighting complements daylighting to meet the required level of illuminance.

APpro, the Profiles Database of the Apache module in IES <VE>, can modulate lighting gain with a time series value in the of 0-1 range. The modular lighting dimming profile is applied in simulations using a “ramp function” to produce the following formula: ramp (e1,0,1,500,0). The formula is suitable for controlling the lighting gain as a function of daylight illumination on the workplane. The value of the profile falls from “1” (at this value there is no daylight on the workplane and the required 500 lx illumination level is provided by artificial light) to “0” (daylight illuminance more than 500 lx) (Apache Profiles Database, 2014). Since it is integrated into the electrical light dimming system, it is critical to calculate the hourly changing lamp heat dissipation in heating and cooling load. This was achieved through the integration of the Apache thermal simulation module of IES <VE> and RadianceIES CBDM technology.

As an electrical lighting system, fluorescent lamps are highly suitable for dimming and are also the more preferred type of lamp in European countries for office lighting (Van Tichelen et al., 2007). In the reference model, artificial lighting consists of 6 high-frequency

tubular T16 fluorescent lamps in high-efficiency lighting luminaries. Lighting Power Density (LPD) was set at 9,7 W/m² and lamp/ballast efficiency was 98 lumens/watt following ASHRAE (2001). The layout and calculations were performed by the FlucsPro IES <VE> module to provide adequate lighting levels not less than 0,8 x illumination design value (500 lx) on the work plane. Calculations show that 6 luminaries (3 luminaries per line) are required (Fig. 7) and therefore light-fitting layout consists of two continuous luminaire rows according to workplace locations (Fig. 8).

For CBDM simulations in RadianceIES, the ceiling, all sidewalls, and floor reflectance values are shown in Table 1 according to the ASHRAE (2001) standard values. RadianceIES uses transmissivity (t_n) rather than transmittance (T_n). Transmissivity (t_n) is the fraction of light passing through the interior of a glass pane at normal incidence, whereas transmittance (T_n) is the ratio of total light measured at normal incidence (RadianceIES: Glossary, 2014). Glazing manufacturers generally use transmittance rather than transmissivity as it is easier to use. However, RadianceIES takes transmissivity as an input

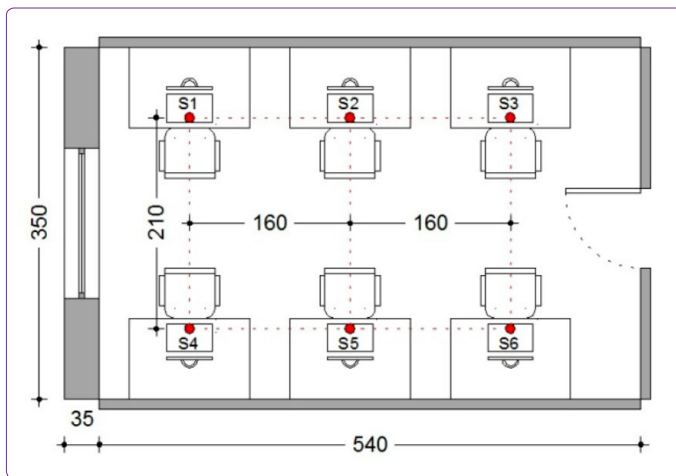

Figure 5. Plan view of daylight control sensors.

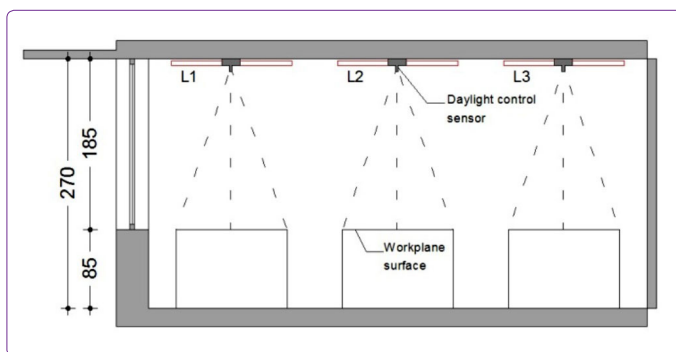

Figure 6. Longitudinal section of daylight control sensors.

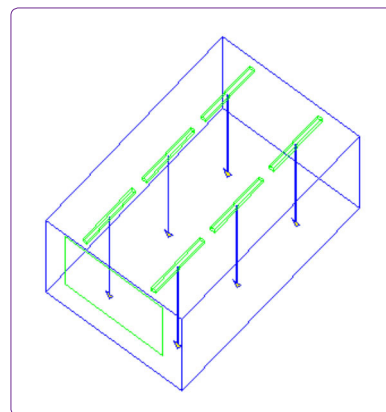

Figure 7. Array of lighting fixtures

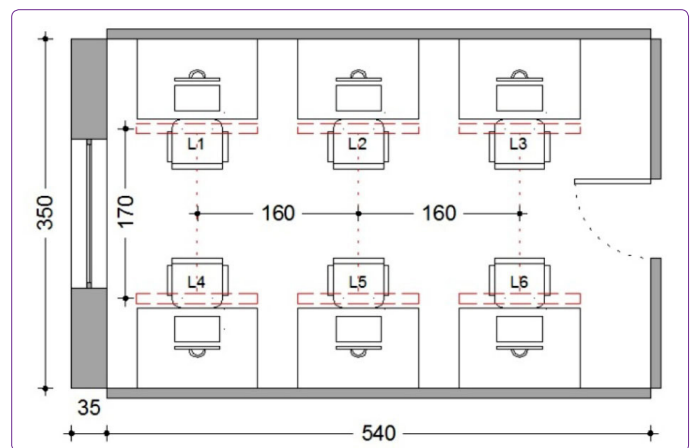

Figure 8. Plan view of lighting fixtures in accordance with workplace positions.

Table 1. Radiance IES material surface properties

1. Ceiling Reflectance	0.80
2. Wall Reflectance	0.70
3. Floor Reflectance	0.20
4. Glazing Transmittance (Tn)	0.76
5. Glazing Transmissivity (tn)	0.83

to its transparent materials and converts transmittance to transmissivity with the formula below.

$$t_n = 1.09 \times T_n \quad (1)$$

In the IES software, a small dialog box allows the user to automatically calculate the transmissivity from transmittance. Using the small dialog box the transmittance value (0,76) is converted to a transmissivity as 0,83. In CBDM simulations no furniture is considered in the office room.

Thermal Analysis

For thermal analysis, the office was occupied from Monday to Friday between 8 a.m. and 6 p.m., according to the IES (2012) occupancy schedule. The HVAC system started at 7 a.m., an hour before the start time, and ended at 6 p.m. Lighting fixtures were in service for four hours in the morning and five hours in the afternoon. The room occupancy index was 0.32 people/m² (6 occupants in 18,9 m² office room). The office was heated with natural gas with a furnace efficiency of 89%. Cooling energy is provided by electricity with the Coefficient Of Performance (COP) 3.2 according to the ASHRAE (2001). The heating setpoint was 20°C in the cold season and the cooling setpoint was 24°C in the warm season. Infiltration heat loss was 0.25 ac/h and air change rate was 10 l/s per person (The Building Regulations, 2010). Ventilation was provided by mechanical ventilation with a heat recovery system with

90% efficiency. Maximum sensible heat gain was defined 90.0 W/person. A total of 6 computers and monitors, each with 110 W, included loads of electrical equipment during the occupation period (Table 2).

Thermal calculations take into account two standards for building envelope design: The first is the national standard TSE 825 (2008) and the second is ASHRAE (2001). According to the national standard of TSE 825, Izmir is located in the 1st climate zone in Turkey and the U-values of walls and windows should be maximum 0.70 (W/m²K) and 2.4 (W/m²K), respectively. On the other hand, ASHRAE (2001) classifies Izmir in Climate Zone 3 and recommends a continuously insulated (c.i) R-9.5 wall for Climate Zone 3. This value is compatible with TSE 825 and is used for the outer wall. Interior walls, floor, and roof are considered adiabatic, assuming they are surrounded by zones with the same indoor thermal conditions.

Considering the location and sunshine hours of Izmir and also building type, it is recommended to use a selective glazing. The choice of glazing in office buildings is very critical because the visible light transmission of glazing is useful for lighting, but direct sunlight transmittance of glazing is not desirable for office workers. Selective low-e cool glazing, (DGU low-e sputtered single silver solar gain control with Argon filling) is therefore used to regulate solar gain and visible light transmittance in response to the climatic needs of the reference office room. The low-e surface is located on Surface 2 (the inner surface of the outer pane) to cut solar heat gain by reflecting invisible infrared and to transmit the visible part of the solar spectrum without compromising daylight. To quantify the performance of the glazing, the light/ solar gain ratio $\{T_n / T_{SHGC} \}$ (T_n : glazing transmittance, SHGC: solar heat gain coefficient) is an important rating. Daylighting is mostly related to the T_n , while cooling energy depends on the T_{SHGC} . The 1.1 value of T_n / T_{SHGC} is recommended by ASHRAE

Table 2. Thermal analysis assumptions

1. People occupancy profile	Between 8 am and 6 pm, From Monday to Friday
2. HVAC occupancy profile	Between 7 am to 6 pm, From Monday to Friday
3. The occupancy index	0.32 people/m ² (6 occupants in 18,9 m ² office room)
4. Heating System	Natural gas with furnace efficiency of 89%
5. Heating setpoint temperature	20°C
6. Cooling System	Electric with the Coefficient Of Performance (COP) as 3.2
7. Cooling setpoint temperature	24°C
8. Ventilation System	Mechanical ventilation with heat recovery system with 90% efficiency
9. Infiltration heat loss	0.25 ac/h
10. Air change rate	10 l/s per person
11. People sensible heat gain	90.0 W/person
12. Equipment heat gain	6 computers and monitors with 110 W of each (6x110W)

Table 3. Thermophysical characteristics of windows

WWR options	Glazing percentage	U _{glass} -value	U _{frame} -value	U _{window} -value	Solar heat gain coefficient (SHGC)	Glazing transmittance (T _n)
10%	76%	1.15	2.40	1.45	0.58	0.75
20%	85%	1.15	2.40	1.34	0.58	0.75
30%	88%	1.15	2.40	1.30	0.58	0.75
40%	90%	1.15	2.40	1.28	0.58	0.75
50%	91%	1.15	2.40	1.26	0.58	0.75
60%	92%	1.15	2.40	1.25	0.58	0.75
70%	92%	1.15	2.40	1.25	0.58	0.75

(2004). In the test model, the T_n / T_{SHGC} ratio was 1.29 for the selected glazing consisting of two panes (4-12-4) with U-value of 1.140 (W/m² K), SHGC of 0,58 and T_n of 0,76.

A composite frame consisting of a hardwood timber frame covered with an external aluminum layer was used for the windows with total U-value of 2.4 W/m²K. By combining the U-value of the window frame with the glazing, the total U-value of the windows varies for each case as the test WWR options have different percentages of window glazing. Table 3 shows the glazing percentages of each case and thermophysical properties of the windows.

Shading Strategy

Direct sunlight is undesirable and causes visual discomfort in office spaces. In addition, the gain from solar energy without shading increases the demand for cooling in the climate of Izmir. To reduce the penetration of sunlight, a static shading device consists of a continuous horizontal overhang with a width of 1 m. was used for the test office (ASHRAE, 2001) (Fig. 9).

The horizontal overhang was mostly applied to the South, East and West facades mostly exposed to the sun, but not in the North. It is particularly suitable for blocking high-angle sunlight in summer, while making maximum use of sun in winter. For CBDM simulations, the surface

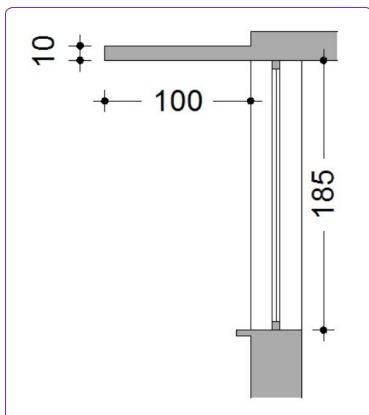

Figure 9. Longitudinal section of horizontal overhang.

reflectance of the overhang was set to 0.5. Dynamic shading devices such as venetian blinds and curtains were not considered for the test room that could not be integrated with the CBDM method in RadianceIES module. This was mainly due to limited software.

Results Lighting Analysis Regarding WWR

As a function of window- wall ratio (WWR) and orientation, climate-based daylight modeling (CBDM) calculations was conducted with RadianceIES in the climate of Izmir. Figure 10 shows the results of CBDM simulations for South, North, East and West orientation. Visualizing Spatial Daylight Autonomy (sDA) with continuous lines, the graphic displays the lighting performance of WWR alternatives. According to the graph, West-facing cases have the highest daylight autonomy, while the North-facing cases have the lowest daylight autonomy in every single option of WWR. In general, cases facing East and South tend to be in line with relatively similar sDA values. According to the IES (2012), 55% sDA_{500,50%} is defined as the *nominally acceptable* threshold, while 75% sDA_{500,50%} is the *preferred* value. When the WWR is at 30%, the South-facing case exceeds the *nominally acceptable* threshold and meets the IES sDA criteria in 55,6% of the analysis area. In this WWR option, North and East-facing cases do not provide the *nominally acceptable* daylight levels, while West-facing case exceeds the *preferred* threshold by meeting the IES criteria in 91,1 of the analysis area. All

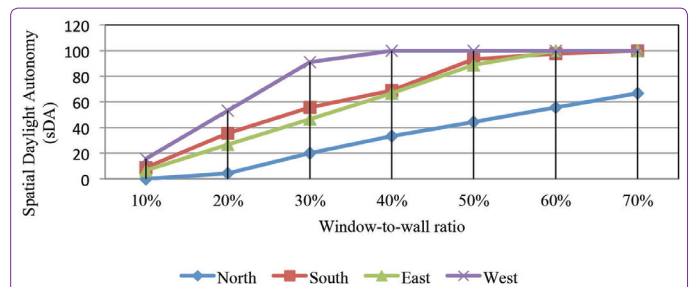

Figure 10. Analysis of Spatial Daylight Autonomy (sDA) regarding WWR and orientation.

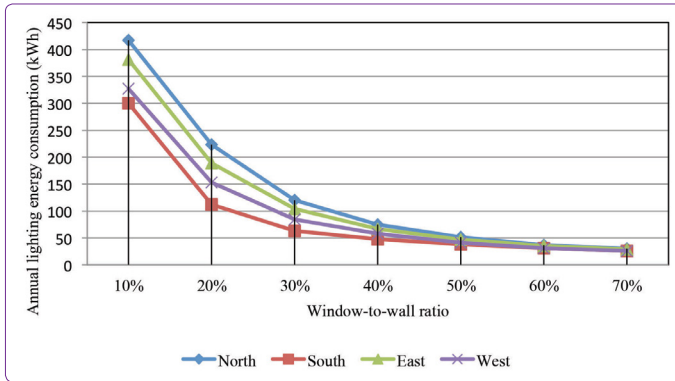

Figure 11. Analysis of annual lighting energy demand regarding WWR and orientation.

the WWR options reach 100 % sDA_{500,50%} value except for North-facing WWRs which provide the lowest performance compared to other cases. For the cases facing North, sDA gradually increases with increasing WWR but fails to reach 100% of the analysis area. For the West-facing cases, while the maximum level is obtained at 40% WWR, the preferred level is achieved at 30% WWR. No case provides the nominally acceptable level below 20% WWR. WWRs that will provide a *nominally acceptable* level should be at least 30% for West and South, 40% for East, 60% for North.

Figure 11 shows the decline in lighting energy with increasing WWR for each orientation. Lighting load drops sharply from 10% to 40% with increasing WWR, and then it slightly decreases as the WWR rises from 40% to 70%. However, no significant reduction in annual lighting energy demand when the WWR exceeds 50%. Due to the least daylight adequacy, the highest lighting load is observed for the North-facing case with 10% WWR while the lowest lighting load is for the South-facing cases.

It is noteworthy that West-facing cases have the highest daylight autonomy, but in South-facing cases, there is the lowest use of lighting energy. Although an electric lighting dimming system integrated with daylighting is applied in all cases, it is clear that daylight autonomy and the use of

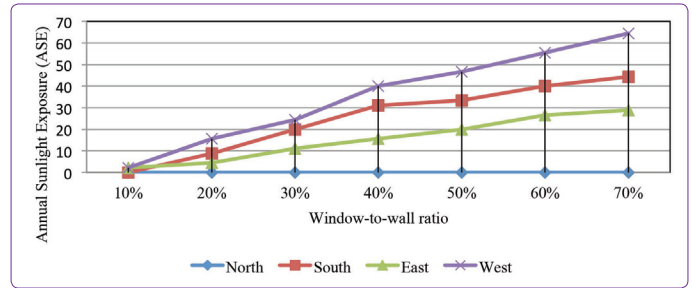

Figure 12. Analysis of annual sunlight exposure demand regarding WWR and orientation.

lighting energy are not in complete consistency between each other. The reason for this is twofold. First, daylight autonomy is calculated for 50% of the analysis time, however, lighting calculations are valid for a full-occupancy time. Second, the sDA calculates illuminance level at many points in the 50 cm range of the analysis area, but electrical lighting mainly depends on daylight levels detected by 6 lighting control sensors.

Figure 12 indicates a rise of Annual Sunlight Exposure (ASE) with an increase in WWR for each orientation. The ASE trend is upwards with a WWR increase for each orientation. West-facing cases have the highest Annual Sunlight Exposure while there is no exposure to sunlight in North-facing cases. According to the IES standards, Annual Sunlight Exposure for ASE_{1000,250h} should not exceed 10% of the analysis area for the *satisfactory* level. It is therefore generally, WWR should be below 30% to provide at least satisfactory visual comfort conditions.

Energy Analysis on WWR

Table 4 summarizes the distribution of energy end-uses with numerical quantities, in terms of WWR. According to the table, cooling load is the leading factor in the overall energy demand compared to heating and lighting loads. It is clearly seen in the Table 4 that the heating load decreases while the cooling load increases in the use of artificial lighting as lighting fixtures dissipate heat as internal gain.

Table 4. Heating, cooling and lighting loads regarding WWR

WWR (%)	South			North			East			West		
	Heating (kWh)	Cooling (kWh)	Lighting (kWh)	Heating (kWh)	Cooling (kWh)	Lighting (kWh)	Heating (kWh)	Cooling (kWh)	Lighting (kWh)	Heating (kWh)	Cooling (kWh)	Lighting (kWh)
10	272	1774	300	279	1781	417	273	1812	381	282	1788	327
20	287	1698	112	290	1731	223	279	1802	189	285	1780	153
30	252	1785	63	296	1733	120	278	1843	104	282	1825	84
40	237	1839	48	298	1769	75	272	1909	67	276	1894	58
50	228	1883	38	302	1805	51	272	1969	47	276	1953	41
60	216	1932	31	302	1845	37	267	2036	35	271	2018	31
70	206	1980	26	302	1885	30	262	2102	29	266	2081	26

For South, East and West-facing cases, in general, higher WWR provides more solar gain and thus reduces the heating load. However, this trend is not valid between 10% and 20% WWR due to the large decrease in internal heat gain in lighting over the heating load. In this range, internal heat gain in lighting is more effective than solar gain on the thermal load. The reverse effect of internal heat gain in lighting on the cooling load is observed. As a result of the increase in WWR, solar gain increases and cooling load also increases. For example, at 70% WWR for the South, the cooling load is 1980 kWh while for the North it is 70% WWR at 1885 kWh. This is due to the impact of orientation and more amount of solar energy gain from the South. However, at 10% WWR, when the lighting load is at the highest level, the cooling load in the North-facing case is bigger than that of the South-facing case, regardless of orientation. A large amount of reduction of internal heat gain from lighting with increase of WWR from 10% to 20% reduces the cooling load.

The use of daylight with an increase of WWR significantly reduces the lighting load. The common contribution of the lighting dimming system and the increase of WWR from 10% to 70% save almost 91-93% lighting energy for each orientation. North-facing cases have the highest lighting load as they reach relatively less daylight illuminance than the other cases.

Integrated Energy Performance On WWR

Figure 13-16 shows the results of daylight autonomy

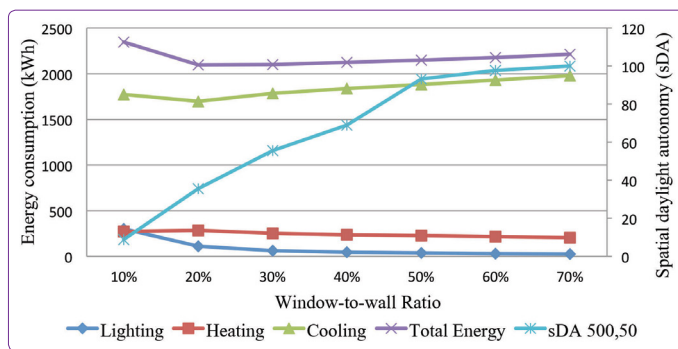

Figure 13. Integrated performances for South.

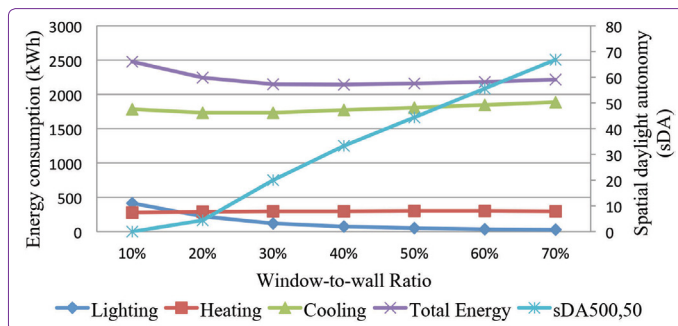

Figure 14. Integrated performances for North.

and energy demand by creating integrated performance indices. Lighting and energy demand of WWR alternatives are evaluated for South, North, East and West orientation. In each of these graphs, daylight assessment results are visualized with continuous lines for sDA, as well as energy consumption for heating, cooling and lighting. The sDA is measured in percentages, as represented on the vertical axis on the right side of the graph. The lines also indicate the energy demand that occurs at kWh on the vertical axis on the left side of the graph. 10% WWR and 70% WWR are two extreme options representing the best and the worst daylight autonomy limit values. The window area is responsible for the variation in lighting performance in this range.

Considering the total demand for heating-lighting and cooling energy, the optimal value of WWR are determined as 20%, 40% and 30% for South, North and East/West, respectively. These values provide the lowest total energy demand, but cannot provide enough daylight levels defined as (55%) for IES standard for nominally acceptable value on the work plane. With WWR increase for all integrated performances, the overall trend in total primary energy demand is first down, and then upward. This is primarily due to the lighting load, while it has a dual effect on the total energy balance. First, the direct effect of the use of electrical energy and secondly the

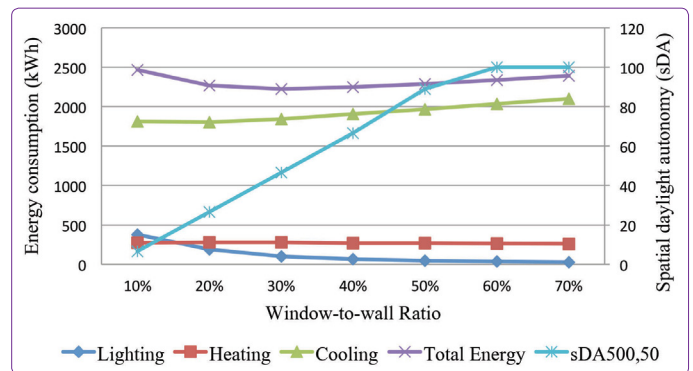

Figure 15. Integrated performances for East.

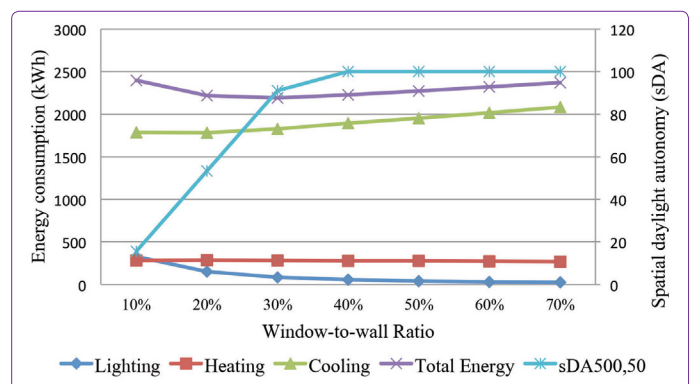

Figure 16. Integrated performances for West.

indirect effect as internal heat gain. When the WWR is between 10% and 30%, lighting load reduces significantly and affects overall energy load considerably. But when the WWR exceeds the 30%, the effect of lighting load on overall energy load reduces due to ever-increasing daylight level. With the discharge of the lighting load, cooling becomes more dominant in the total energy balance. Although the test model uses selective glass with low SHGC and external shading, it is the most effective factor in the energy equation. Such a demand for the higher amount of cooling indicates the importance of selection of appropriate glazing properties and shading with some potential for cutting solar gain in this climate. However, heating is less effective on total energy balance compared to lighting and cooling. High internal heat gain from lighting fixtures at low WWRs reduces heating demand.

Overall Performance Assessment and Determination of Optimal WWR

Table 5 reports annual sDA and ASE performance related to WWR for four orientations. The lightest emphasis for sDA metric is over >75% of the sDA defined as the preferred value in IES standards (IES, 2012). The darkest highlight is defined as an insufficient value below <55% of the SDA, while the medium-dark highlight shows a nominally acceptable value of between 55% and 75%. The boldest emphasis for ASE metric corresponds to ASE below 3%,

defined as the preferred value in IES standard (IES, 2012). The lightest emphasis presents ASE above 10%, which is defined as an unacceptable value. The two medium-thick emphasis indicate nominally acceptable sDA between 3% and %7 and a satisfactory level between 7% and %10. As integrated into Table 5, Table 6 is generated to show the overall performance scheme and find the optimal WWR that asses sDA, ASE and total energy demand together. To evaluate the performance of sDA and ASE, Table 6 uses the characters A, B, C for sDA and X, Y, Z and Q for ASE. It is also the total amount of energy shown in the numerical values at Table 6.

According to Table 6, the total energy demand for best possible case of the south-facing case with 20% WWR, with the lowest energy in 2097 kWh is a remarkable finding. Though, no significant difference in energy use (almost 1-2%) is found between 20%, 30% and 40% WWRs. This condition provides us with the broadest selection framework for defining the optimal WWR in terms of energy consumption.

Considering the total energy use for heating, cooling, and lighting only, the optimum WWR found to be 20%, 40% and 30% for South, North and East/West, respectively. Nevertheless, these values cannot meet the least nominally acceptable Spatial Daylight Autonomy (sDA) except for the West-facing case. Additionally, the introduction of the visual discomfort metric, the Annual Sunlight Exposure (ASE) makes the definition of optimal WWR more difficult

Table 5. Spatial Daylight Autonomy (sDA) and Annual Sunlight Exposure (ASE) performance indexes as a function of WWR for South, North, East and West

WWR (%)	South		North		East		West	
	sDA 500,50%	ASE 1000,250h	sDA 500,50%	ASE 1000,250h	sDA 500,50%	ASE 1000,250h	sDA 500,50%	ASE 1000,250h
10	8,9	0	0	0	6,7	2,22	15,6	2,22
20	35,6	8,89	4,4	0	26,7	4,44	53,3	15,56
30	55,6	20	20	0	46,7	11,11	91,1	24,44
40	68,9	31,11	33,3	0	66,7	15,56	100	40
50	93,3	33,33	44,4	0	88,9	20	100	46,67
60	97,8	40	55,6	0	100	26,67	100	55,56
70	100	44,44	66,7	0	100	28,89	100	64,44

SDA500, 50%	<55% Insufficient	55%-75% Nominally acceptable	>75% Preferred	ASE1000, 250h	<3% Preferred	3%-7% Nominally acceptable	7%-10% Satisfactory	>10% Unacceptable

Table 6. Spatial Daylight Autonomy (sDA) and Annual Sunlight Exposure (ASE) performance indexes as a function of WWR for South, North, East and West

	South	North	East	West
WWR	sDA-ASE-Total Energy	sDA-ASE-Total Energy	sDA-ASE-Total Energy	sDA-ASE-Total Energy
10%	C-X-2346 kWh	C-X-2477 kWh	C-X-2466 kWh	C-X-2397 kWh
20%	C-Z-2097 kWh	C-X-2244 kWh	C-Y-2270 kWh	C-Q-2218 kWh
30%	B-Q-2100 kWh	C-X-2149 kWh	C-Q-2225 kWh	A-Q-2191 kWh
40%	B-Q-2124 kWh	C-X-2142 kWh	B-Q-2248 kWh	A-Q-2228 kWh
50%	A-Q-2149 kWh	C-X-2158 kWh	A-Q-2288 kWh	A-Q-2270 kWh
60%	A-Q-2179 kWh	B-X-2183 kWh	A-Q-2338 kWh	A-Q-2320 kWh
70%	A-Q-2212 kWh	A-X-2214 kWh	A-Q-2393 kWh	A-Q-2373 kWh

<p>Spatial Daylight Autonomy for sDA_{500,50}</p> <p>A: Preferred Daylight levels > 75% of the area</p> <p>B: Nominally Acceptable Daylight levels > 55% of the area</p> <p>C: Unsatisfactory Daylight levels</p>	<p>Annual Sunlight Exposure for ASE_{1000,250h}</p> <p>X: Preferred threshold < 3% of the area</p> <p>Y: Nominally Acceptable threshold < 7% of the area</p> <p>Z: Satisfactory threshold < 10% of the area</p> <p>Q:Unacceptable threshold</p>
<p>*Optimal WWR</p>	

since sDA and ASE metrics are inversely correlated in defining the optimal WWR. As long as WWR increases the performance of Spatial Daylight Autonomy increases but the performance of Annual Sunlight Exposure decreases. For small WWRs, the sDA is too low, although the ASE requirements could be met. To offset all these effects, optimal WWR should provide the optimized conditions with *low energy* use, at least acceptable daylight sufficiency and at least satisfactory sunlight exposure. To meet this, using the *low energy* target instead of the *lowest energy* can trade-off sDA, energy and ASE performance and provide the optimal WWR in many respects.

For the *South case*, the ideal WWR was found to be 20%, 70% and 10% in terms of the *lowest energy* demand, *preferred* Spatial Daylight Autonomy (sDA) and *preferred* Annual Sunlight Exposure (ASE), respectively. 20% WWR provides the lowest energy and meet the corresponding threshold for ASE that a maximum of 8, 89% of the analysis area can exceed 1000 lx for more than 250 h per year in occupancy hours between 8 am and 6 pm. However, at least 30% WWR can meet the corresponding threshold, *nominally acceptable* sDA value (55%) annually. The 30% WWR case consumes 3 kWh more energy than 20% WWR case. This

difference accounts for the 0,14 % of the total energy, so can be neglected. On the other hand, 30% WWR could not meet the ASE requirement because 20% of the analysis area can exceed 1000 lx for more than 250 h per year. However with the addition of the internal blind or curtain, visual discomfort should be reduced to at least 10% and *satisfactory* ASE level should be provided. For this reason, 30% WWR is the optimal option for the southern orientation and is therefore called optimal WWR in this study.

For the *North case*, the ideal WWR was found to be 40% and 70% respectively, in terms of the lowest energy demand and *preferred* Spatial Daylight Autonomy (sDA) respectively. The 40% WWR has the lowest energy demand but cannot meet the *nominally acceptable* daylight levels of the IES standard. However, the 60% WWR meet the corresponding threshold for the annual sDA value (55%) and it consumes 41 kWh more energy than 40% WWR option. This difference is a very small amount that equals to 1,9% in total energy demand. Therefore, 40 % WWR was eliminated and 60% WWR was determined as the *optimal WWR* in this study. In defining the optimal WWR, ASE metric was not considered as all WWR options provide the preferred ASE threshold (<3%).

For the East case, the ideal WWR was found to be 30%, 60-70% and 10% in terms of the lowest energy demand, preferred Spatial Daylight Autonomy (sDA) and preferred Annual Sunlight Exposure (ASE), respectively. The 30% WWR option has the lowest energy demand at 2225 kWh, but could not meet the *nominally acceptable* daylight level and *satisfactory* sunlight exposure.

While 20% WWR provides merely *nominally acceptable* sunlight exposure, 40% WWR provides a *nominally acceptable* daylight level. The 40% WWR option consumes 23 kWh (1%) more energy than the 30% WWR, and this is negligible. However for the 40% WWR option, the analysis area has 15,56 unsatisfactory visual discomfort value for ASE_{1000,250h}. This value is above the 10% threshold for the *satisfactory level*. For this reason, 40% WWR was determined as the optimal option for East orientation and was called as optimal WWR in this study. However, along with the horizontal overhang, an inner blind or curtain should be used to reduce visual discomfort by 10% to achieve the least *satisfactory* ASE level.

For the West case, the ideal WWR was determined to be 30%, 40-70% and 10% in terms of the lowest energy demand, preferred Spatial Daylight Autonomy (sDA), and preferred Annual Sunlight Exposure (ASE), respectively. The 30% WWR option has the lowest energy consumption and meets the preferred daylight levels for 91,1% analysis area for sDA_{500,50%}. Yet, 24,44 of the analysis area has unsatisfactory visual discomfort for ASE_{1000,250h}. As in the East and South cases, visual comfort should be improved with the use of inner blind or curtain to regulate sunlight exposure when the sunlight is strong. Therefore 30% WWR was determined as the *optimal WWR for West case* in this study.

As a result, with the introduction of the overall (sDA, ASE and energy) performance scheme, daylight and energy benefits were balanced by identifying optimal WWRs for each orientation. For the South, West and East cases, it is important to further improve the visual discomfort by using additional inner blinds.

Discussion

To sum up, this study follows a *hybrid model* approach for an office in Izmir using climate-based analysis to figure out the optimal WWR in terms of overall energy performance for heating, cooling and lighting, daylight autonomy and annual sunlight exposure. When integrated performances became a matter of the concern, 30% WWR in the South, 60% WWR in the North, 40% WWR in the East and 30% WWR in the West were the recommended sizes of windows that consumed the least energy and, as general findings, provided the best daylight penetration/performance in Izmir.

Despite the similarities between the overall results of this study and previous studies conducted in different climates of cities, this study exhibits remarkable findings using the latest dynamic daylight metrics and *hybrid model* approach. For example, the minimum window size for the South and East facades in Izmir (38° latitude) was found to be 30%, different from the wider window size range of 10-40% in the study of Acosta et al. (2016), which dealt with four locations - London, Madrid, Munich, Stockholm - and accepted the threshold illuminance as 250 lx excluding energy consumption. In our study, the best solution for the North façade in Izmir is 60% WWR, however, in the case of Madrid (40° latitude) in the study of Acosta et al. this is 10-20%. The integration of energy demand, the required illuminance and acceptable visual comfort according to IES standards are obviously effective on making the window size decisions, as opposed to previous study.

Ochoa et al. (2012) focused on finding optimal WWR using similarly the IEA Task 27 reference office with typical occupancy, load conditions and lighting dimming system in the Amsterdam's warm climate, where sunlight hours and average air temperature are relatively lower than the climate of Izmir (Mediterranean). The study considers acceptable visual comfort, as well as illuminance performance and the least energy use to find optimal WWR. The recommended window sizes in terms of minimum energy usage were found to be 30% for the North and 20% for the South, East and West. It is also stated that WWRs that consume minimum total energy have the lowest visual performance. Given the acceptable visual comfort and illuminance performance along with the energy issue, working as optimal WWRs recommends 70% for the North, 60% for the South, East and West. These findings are relatively larger than our findings, since the mentioned study on illumination performance uses the level of *critical region* that "a limit when increasing window size does not contribute any more to daylight availability" instead of minimal acceptance criteria using performance metrics such as sDA and ASE. This clearly shows the importance of selected metrics and evaluation method in the making of window size decision.

Globally, reducing the amount of glazing in offices has been demonstrated to reduce energy load, and fully-glazed office buildings appear not to provide additional energy savings and daylight benefits. However, it should be noted that optimal WWR options are valid in the context of climate and geography of each analysis. There has been no constant WWR value agreed on yet; so it is still necessary to test the mutual effects of the amount of glazing and the total energy use with a pure, simple and daylight model.

In this study, fluorescent lamps were used in electrical lighting system, because they are more preferred lamp types in office lighting. Instead of fluorescent lamps,

LEDs can be used as a more energy-efficient alternative as the lamp/ballast efficiency is higher than fluorescent lamps. In energy calculations, the lighting energy load decreases slightly by using LEDs compared to fluorescent lamps. In addition, since the LEDs do not disperse heat like fluorescent lamps, the cooling load decreases slightly while the total heating load increases.

Conclusion

In this study different window-to-wall ratios were compared and variations were tested to explore how the overall energy-saving, adequate daylight autonomy and visual comfort are precisely balanced by WWR. The findings of integrated thermal-lighting simulations underline optimal WWRs in accordance with *low energy demand*, providing the minimum *acceptable daylight autonomy* and visual comfort possible according to IES standards for the four main orientations in the Izmir climate. WWR was found to have a profound impact on the the energy equation and daylight autonomy. Integrated simulation results showed that a WWR increase from 10% to 30% on the south façade can reduce the demand for artificial lighting to 79% and overall energy demand to almost 11%. Yet, maximum use of WWR-related daylight saves substantial artificial lighting energy, but it causes a significant increase in overall primary energy demand as much of the energy demand is originated from the cooling in the climate of Izmir. Therefore it is more effective to control artificial lighting on the overall energy equation to reduce the use of cooling energy. This requires keeping WWR as low as possible. However, low values of WWR provide insufficient daylight illuminance and WWR needs to be kept high for more daylight. Along with these aspects, visual discomfort increases noticeably while holding high levels of WWR. Within this framework, this study points out that a largest-glazed case (70% WWR) cannot provide more daylight benefit compared with i.e. 40% WWR in the West, or 60% in the East, but can cause substantial energy demand.

When taking into account of both daylight autonomy and energy-saving, firstly, the “*nominally acceptable*” daylight level is defined as a critical point. The WWRs at the critical point were found to be 30% for the South and West, 40% for the East and 60% for the North. These WWRs provide *nominally acceptable* daylight criteria of IES for $sDA_{500,50\%}$ and also consumes merely (1 or 2%) more energy than the WWR options that meet the lowest energy. WWR values above the *nominally acceptable* daylight point are not advisable in terms of visual discomfort and overall energy performance. This option showed us the probability of window size, which provides lower energy consumption without neglecting daylight performance. Therefore, these values were determined as optimal WWRs in this

study. However, especially the South, East and West-facing cases require the inner blind or curtain to mitigate direct sunlight and excessive daylight illuminance. In this study, an inner blind could not be modelled integrated with climate-based daylighting approach since RadianceIES is not capable of considering this option yet. This is the main limitation of this study. However, for further research, the use of dynamic shading device will be examined through the development of RadianceIES CBDM technology to understand the impact on WWR integrated with climate-based daylight and thermal energy modeling.

In view of these comparative findings, designers can get feedback about window design with its strong influence on energy use in heating, cooling and lighting, both in a separate and integrated way. Given that this hypothetical study points out that electrical power is the strongest element in the distribution of energy-end uses in cooling of the climate in Izmir, even for the North façade, the cooling systems powered by electricity and subsequent release of CO₂ into the environment will be considered for further studies. Such a message needs to be conveyed to designers while comparing the results of WWR alternatives.

References

- Acosta, I., Campano, M. Á., & Molina, J. F. (2016). Window design in architecture: Analysis of energy savings for lighting and visual comfort in residential spaces. *Applied Energy*, 168, 493-506. <https://doi.org/10.1016/j.apenergy.2016.02.005>
- American Society of Heating, Refrigerating, & Air-Conditioning Engineers. (2001). Standard Method of Test for the Evaluation of Building Energy Analysis Computer Programs (Standard No:140). American Society of Heating, Refrigerating and Air-Conditioning Engineers, Incorporated. http://www.eep-performance.org/uploads/8/6/5/0/8650231/ashrae_140.pdf
- American Society of Heating, Refrigerating, & Air-Conditioning Engineers. (2004). *Advanced Energy Design Guide for Small Office Buildings*. American Society of Heating, Refrigerating and Air-Conditioning Engineers, Incorporated. <https://www.ashrae.org/technical-resources/aedgs/50-percent-aedg-free-download>
- American Society of Heating, Refrigerating, & Air-Conditioning Engineers. (2001). *Energy Standard for Buildings Except Low-Rise Residential Buildings* (Standard No: 90.1). American Society of Heating, Refrigerating and Air-Conditioning Engineers, Incorporated.
- APpro, the Profiles Database of the Apache module in IES <VE>, can modulate lighting gain with a time series value in the of 0-1 range. The modular lighting dimming profile is applied in simulations using a “ramp function” to produce the following formula: ramp (e1,0,1,500,0). The formula is suitable for controlling the lighting gain as a function of daylight illumination on the workplane. The value of the profile falls from “1” (at this value there is no daylight on the workplane and the required 500 lx illumination level is provided by artificial light) to “0” (daylight illuminance more than 500 lx) (Apache Profiles Database, 2014). Since it is integrated into the electrical light dimming system, it is critical to calculate

- the hourly changing lamp heat dissipation in heating and cooling load. This was achieved through the integration of the Apache thermal simulation module of IES <VE> and Radiance/IES CBDM technology.
- Apache Profiles Database. (2014). APpro User Guide. IES Virtual Environment. https://www.iesve.com/downloads/help/Thermal/5.9_APPro.pdf
- Attia, S., Beltrán, L., De Herde, A., & Hensen, J. (2009). "Architect friendly": A comparison of ten different building performance simulation tools. Proceedings of the IBPSA 2009–International Building Performance Simulation Association Conference and Exhibition, Glasgow, UK, 204–211. https://orbi.uliege.be/bitstream/2268/167578/1/BS09_0204_211.pdf
- Bayram, G. (2015). A Proposal For A Retrofitting Model For Educational Buildings In Terms of Energy Efficient Lighting Criteria. [Unpublished doctoral dissertation]. İzmir Institute of Technology.
- Berardi, U., & Anaraki, H. K. (2018). The benefits of light shelves over the daylight illuminance in office buildings in Toronto. *Indoor and Built Environment*, 27(2), 244-262. <https://doi.org/10.1177/1420326X16673413>
- Bostancıoğlu, E., & Telatar, B. (2013). Effect of window size on residential buildings' energy costs. *World Applied Sciences Journal*, 21(4), 631-640. <https://doi.org/10.5829/idosi.wasj.2013.21.4.860>
- Boyce, P. R., & Smet, K. A. G. (2014). LRT symposium 'Better metrics for better lighting'—a summary. *Lighting Research & Technology*, 46(6), 619-636. <https://doi.org/10.1177/1477153514558161>
- Chen, X., & Yang, H. (2015). Combined thermal and daylight analysis of a typical public rental housing development to fulfil green building guidance in Hong Kong. *Energy and Buildings*, 108, 420-432. <https://doi.org/10.1016/j.enbuild.2015.09.032>
- CIBSE Lighting Guide 10. (1999). Daylighting and window design. The Chartered Institution of Building Services Engineers. <https://nowalcott.files.wordpress.com/2010/03/daylighting-and-window-design.pdf>
- Clarke, J. A., Janak, M., & Ruyssevelt, P. (1998). Assessing the overall performance of advanced glazing systems. *Solar Energy*, 63(4), 231-241. [https://doi.org/10.1016/S0038-092X\(98\)00034-6](https://doi.org/10.1016/S0038-092X(98)00034-6)
- Crawley, D. B., Hand, J. W., Kummert, M., & Griffith, B. T. (2005). Contrasting the capabilities of building energy performance simulation programs, Proceeding of ninth international IBPSA conference, Montreal, Canada, 15-18. http://www.ibpsa.org/proceedings/BS2005/BS05_0231_238.pdf
- Fasi, M. A., & Budaiwi, I. M. (2015). Energy performance of windows in office buildings considering daylight integration and visual comfort in hot climates. *Energy and Buildings*, 108, 307-316. <https://doi.org/10.1016/j.enbuild.2015.09.024>
- Freewan, A. A. (2015). Developing daylight devices matrix with special integration with building design process. *Sustainable Cities and Society*, 15, 144-152. <https://doi.org/10.1016/j.scs.2014.11.003>
- Goia, F. (2016). Search for the optimal window-to-wall ratio in office buildings in different European climates and the implications on total energy saving potential. *Solar Energy*, 132, 467-492. <https://doi.org/10.1016/j.solener.2016.03.031>
- Halonen, L., Tetri, E. & Bhusal, P. (2010). Guidebook on energy efficient electric lighting for buildings. Aalto University, School of Science and Technology, Department of Electronics Lighting Unit. http://www.ecbcs.org/Data/publications/EBC_Anex_45_Guidebook.pdf
- Heschong, L. (2002). Daylighting and human performance. *ASHRAE journal*, 44(6), 65-67. <http://www.livingdaylights.nl/wp-content/uploads/2016/12/Heschong-2002.-Daylighting-and-Human-performance.pdf>
- IESNA Lighting Handbook. (2000). The Standard Lighting Guide. Illuminating Engineering Society of North America.
- Inanici, M. N., & Demirbilek, F. N. (2000). Thermal performance optimization of building aspect ratio and south window size in five cities having different climatic characteristics of Turkey. *Building and Environment*, 35(1), 41-52. [https://doi.org/10.1016/S0360-1323\(99\)00002-5](https://doi.org/10.1016/S0360-1323(99)00002-5)
- International Energy Agency. (2006). Light's Labour's Lost, IEA Publications. <https://www.osti.gov/etdeweb/servlets/purl/20836234>
- Jakubiec, J. A., & Reinhart, C. F. (2011). DIVA 2.0: Integrating daylight and thermal simulations using Rhinoceros 3D, Daysim and EnergyPlus. Proceedings of building simulation, Sydney, 20(11), 2202-2209. http://ibpsa.org/proceedings/BS2011/P_1701.pdf
- Kazanasmaz, T., Grobe, L. O., Bauer, C., Krehel, M., & Wittkopf, S. (2016). Three approaches to optimize optical properties and size of a South-facing window for spatial Daylight Autonomy. *Building and Environment*, 102, 243-256. <https://doi.org/10.1016/j.buildenv.2016.03.018>
- Leonidaki, K., Kyriaki, E., Konstantinidou, C., Giama, E., & Papadopoulos, A. M. (2014). Thermal performance of office building envelopes: the role of window-to-wall ratio and thermal mass in Mediterranean and Oceanic climates. *Journal of Power Technologies*, 94(2), 128-134. <http://papers.itc.pw.edu.pl/index.php/JPT/article/view/550>
- Li, D. H., Wong, S. L., Tsang, C. L., & Cheung, G. H. (2006). A study of the daylighting performance and energy use in heavily obstructed residential buildings via computer simulation techniques. *Energy and Buildings*, 38(11), 1343-1348. <https://doi.org/10.1016/j.enbuild.2006.04.001>
- LM, I. (2013). Approved method: IES spatial Daylight autonomy (sDA) and annual sunlight exposure (ASE). Illuminating Engineering Society. <https://www.ies.org/product/ies-spatial-daylight-autonomy-sda-and-annual-sunlight-exposure-ase/>
- Mangkuto, R. A., Rohmah, M., & Asri, A. D. (2016). Design optimisation for window size, orientation, and wall reflectance with regard to various daylight metrics and lighting energy demand: A case study of buildings in the tropics. *Applied Energy*, 164, 211-219. <https://doi.org/10.1016/j.apenergy.2015.11.046>
- Melendo, J. M. A., & Roche, P. (2009). Effects of window size in daylighting and energy performance in buildings. Proceedings of the PLEA, 26th Conference on Passive and Low Energy Architecture, Quebec City, Canada.
- Meresi, A. (2016). Evaluating daylight performance of light shelves combined with external blinds in south-facing classrooms in Athens, Greece. *Energy and Buildings*, 116, 190-205. <https://doi.org/10.1016/j.enbuild.2016.01.009>

- Nabil, A., & Mardaljevic, J. (2005). Useful daylight illuminance: a new paradigm for assessing daylight in buildings. *Lighting Research & Technology*, 37(1), 41-57. <https://doi.org/10.1191/1365782805li128oa>
- Nabil, A., & Mardaljevic, J. (2006). Useful daylight illuminance: A replacement for daylight factors. *Energy and Buildings*, 38(7), 905-913. <https://doi:10.1016/j.enbuild.2006.03.013>
- Nasrollahi, F. (2010). Window area in office buildings from the viewpoint of energy efficiency. *Proceedings of the Third German-Austrian IBPSA Conference Vienna University of Technology*. http://info.tuwien.ac.at/bausim/conftool/nasrollahi-2010-window_area_in_office_buildings_from_the_viewpoint-180.pdf
- Ochoa, C. E., Aries, M. B., Van Loenen, E. J., & Hensen, J. L. (2012). Considerations on design optimization criteria for windows providing low energy consumption and high visual comfort. *Applied Energy*, 95, 238-245. <https://doi.org/10.1016/j.apenergy.2012.02.042>
- Öner Ö. C. (2020). Comparison of Architectural Design Parameters In Traditional Buildings In Terms Of Energy Performance For Future Housing Design. [Unpublished doctoral dissertation]. İzmir Institute of Technology.
- Özkan, D. B., & Onan, C. (2011). Optimization of insulation thickness for different glazing areas in buildings for various climatic regions in Turkey. *Applied Energy*, 88(4), 1331-1342. <https://doi.org/10.1016/j.apenergy.2010.10.025>
- Poirazis, H., & Blomsterberg, Å. (2005). Energy and thermal analysis of glazed office buildings using a dynamic energy simulation tool. *Proceeding of ninth international IBPSA conference, Montreal, Canada*, 945-952. http://www.ibpsa.org/proceedings/BS2005/BS05_0945_952.pdf
- RadianceIES:Glossary. (2014). IES Virtual Environment. <https://docplayer.net/61802765-Radianceies-glossary.html>
- Reinhart, C. F. (2002). Effects of interior design on the daylight availability in open plan offices. *Proceedings of the 2002 American Council for an Energy Efficient Economy (ACEEE) Summer Study on Energy Efficiency in Buildings*, 3, 309-322.
- Reinhart, C. F. (2014). *Daylighting handbook: fundamentals, designing with the sun*. Christoph Reinhart. <https://architecture.mit.edu/publication/daylighting-handbook-i>
- Standard DIN. (1994). Daylight in interiors- Simplified regulation for minimum window sizes. (Standard No.5034-4). German Institute for Standardisation.
- The Building Regulations. (2010). Approved Document F1A: Means of Ventilation. National Building Services.
- TSE 825. (2008) Thermal Insulation Requirements for Buildings. Turkish Standard Institution.
- Turkish State Meteorological Service. Climate Data. Turkey. <https://www.mgm.gov.tr/veridegerlendirme/il-ve-ilceler-istatistik.aspx?m=IZMIR>
- Tzempelikos, A., & Athienitis, A. K. (2005). Integrated Thermal and Daylighting Analysis for Design of Office Buildings. (Standard No: 111-1). American Society of Heating, Refrigerating and Air-Conditioning Engineers, Incorporated.
- Tzempelikos, A., & Athienitis, A. K. (2006, September). Shading as an active component for solar control: an integrated approach at the early design stage. *Proceedings of the PLEA, 26th Conference on Passive and Low Energy Architecture*, Quebec City, Canada.
- Tzempelikos, A., & Athienitis, A. K. (2007). The impact of shading design and control on building cooling and lighting demand. *Solar Energy*, 81(3), 369-382. <https://doi.org/10.1016/j.solener.2006.06.015>
- Ünlü, N. P. B. (2018). An Investigation Into Fenestration Strategies on Building Performance: Case of Residential Buildings In Turkey. [Unpublished master's thesis]. Yaşar University.
- Van DIJK, D., & Platzer, W. J. (2003). Reference office for thermal, solar and lighting calculations. (Report No. swift-wp3-tno-dvd-030416). International Energy Agency (IEA) Task 27.
- Van Tichelen, P., Geerken, T., Jansen, B., Bosch, M. V., Van Hoof, V., Vanhooydonck, L., & Vercajsteren, A. (2007). Preparatory studies for eco-design requirements of EuPs. Final Report: Lot, 9: Public street lighting. VITO.
- Yıldız, Y., Özbalta, T. G., & Arsan, Z. D. (2011). Impact of Window-to-Wall Surface Area for Different Window Glass Types and Wall Orientations on Building Energy Performance: A Case Study for a School Building Located in İzmir, Turkey//Farklı Cam Türleri ve Yönler Göre Pencere/Duvar Alanı Oranının Bina Enerji Performansına Etkisi: Eğitim Binası, İzmir. *Megaron*, 6(1), 30.
- Yılmaz, Y., & Yılmaz, B. Ç. (2020). A weighted multi-objective optimisation approach to improve based facade aperture sizes in terms of energy, thermal comfort and daylight usage. *Journal of Building Physics*, 1744259120930047. <https://doi.org/10.1177/1744259120930047>