

**Speciation and Preconcentration of Inorganic
Antimony and Manganese in Waters Using
Microcolumn-Flow Injection System and
Determination by
Atomic Absorption Spectrometry**

**By
Aşlı ERDEM**

**A Dissertation Submitted to the
Graduate School in Partial Fulfillment of the
Requirements for the Degree of**

MASTER OF SCIENCE

**Department: Chemistry
Major: Chemistry**

**İzmir Institute of Technology
İzmir, Turkey**

September, 2003

ACKNOWLEDGEMENTS

I would like to express my gratitude to my advisor Assoc. Prof Dr. Ahmet E. EROĞLU for his excellent supervision, help, guidance and encouragement he provided throughout my thesis.

I also would like to thank to other members of the thesis committee, Prof. Dr. O. Yavuz ATAMAN, Prof. Dr. Emür HENDEN, Prof. Dr. Tamerkan ÖZGEN and Asst. Prof. Dr. Durmuş ÖZDEMİR for their valuable comments and suggestions.

I am very grateful to my sister Arzu ERDEM, and my friends Müşerref YERSEL, Filiz PARLAYAN, Murat ERDOĞAN and Sinan YILMAZ for their help, patience and encouragement in every step of my study.

Special thanks to Mr. Polat BULANIK and Miss Dilek ÖZCANŞEN for their friendship and support during this thesis.

Finally, I am thankful to my father and mother for their help and understanding.

TABLE OF CONTENTS

LIST OF FIGURES	vi
LIST OF TABLES	vii
CHAPTER 1 INTRODUCTION	1
1.1. The Philosophy of Trace Analysis	1
1.2. Speciation of Trace Elements in Waters	6
1.3. Hydride Generation Atomic Absorption Spectrometry	8
1.4. Flow Injection Analysis (FIA)	9
1.5. Antimony.....	13
1.5.1. Antimony in Nature.	13
1.5.2. Antimony Speciation	15
1.5.3. Methods for Antimony Determinations	17
1.6. Manganese	19
1.6.1. Manganese in Nature	19
1.6.2. Manganese Speciation	20
1.7. Aim of This Work	22
CHAPTER 2 EXPERIMENTAL	23
2.1. Chemicals and Reagents.....	23
2.2. Instrumentation.....	24
2.2.1. HGAAS for Sb.....	24
2.2.2. FAAS for Mn	25
2.2.3. ETAAS for Sb	25
2.3. Determination of Antimony	26
2.3.1. Optimization of HGAAS Parameters for Sb Determinations	26
2.3.1.1. Sb(III) Signal	26
2.3.1.1.1. Effect of HCl Concentration	26
2.3.1.1.2 Effect of NaBH ₄ Concentration	26
2.3.1.1.3. Carrier Gas Flowrate	27
2.3.1.2. Sb(V) Signal	27
2.3.1.2.1. Pre-reduction of Sb(V) to Sb(III)	27
2.3.1.3. Calibration Curves for Sb(III) and Sb(V)	27

2.3.2. Speciation and Preconcentration of Sb(III) and Sb(V) using Solid Sorbents	28
2.3.2.1. Sorption	28
2.3.2.1.1. Batch Type	28
2.3.2.1.1.1. Types of Sorbents	28
2.3.2.1.2. Desorption from the Sorbents	29
2.3.2.1.3. Microcolumn Sorption	29
2.3.2.1.3.1. Effect of Microcolumn Length	30
2.3.2.1.3.2. Effect of the Sorbent Particle Size	30
2.3.2.1.3.3. Effect of Flowrate during Deposition and Elution in Microcolumns	30
2.3.2.1.4. Extraction Efficiency as a function of pH	31
2.3.2.1.5. Performance of Speciation and Preconcentration Steps	31
2.3.2.1.5.1. Preconcentration Ratio	31
2.3.3. Method Validation	31
2.3.3.1. Recoveries with Sb(III) and Sb(V)	31
2.3.3.2. Performance of the Study	32
2.3.3.3. Analysis of Real Samples	32
2.4. Manganese Determinations	33
2.4.1. Calibration Curves for Mn(II) and Mn(VII).....	33
2.4.2. Speciation of Mn(II) and Mn(VII) using Solid Sorbents	33
2.4.2.1. Sorption	33
2.4.2.2. Effect of Solution pH on Sorption of Mn(II) and Mn(VII)	34
2.4.2.3. Desorption from the Sorbents	34
2.4.2.4. Recovery of the Proposed Method	35
CHAPTER 3 RESULTS AND DISCUSSION	36
3.1. Determination of Antimony	36
3.1.1. Optimization of HGAAS for Antimony Determinations	36
3.1.1.1. Sb(III) Signal	36
3.1.1.1.1. Effect of HCl Concentration	36
3.1.1.1.2. Effect of NaBH ₄ Concentration	38

3.1.1.1.3. Carrier Gas Flowrate	39
3.1.1.2. Sb(V) Signal	40
3.1.1.2.1. Pre-reduction of Sb(V) to Sb(III)	40
3.1.1.3. Calibration Curves for Sb(III) and Sb(V)	43
3.1.2. Speciation and Preconcentration of Sb(III)	
and Sb(V) Using Solid Sorbents	45
3.1.2.1 Sorption	45
3.1.2.1.1 Batch Type	45
3.1.2.1.2. Elution from the Sorbents	47
3.1.2.1.3. Microcolumn Sorption	48
3.1.2.1.3.1. Effect of Microcolumn Length	48
3.1.2.1.3.2. Effect of Sorbent Particle Size	49
3.1.2.1.3.3. Effect of flowrate during deposition	
and elution in microcolumns	49
3.1.2.1.4. Extraction Efficiency as a Function of pH	49
3.1.2.1.5. Performance of Speciation and	
Preconcentration Steps	50
3.1.2.1.5.1. Preconcentration Ratio	50
3.1.3. Method Validation	52
3.1.3.1 Recoveries with Sb(III) and Sb(V)	52
3.1.3.2. Performance of the Study	54
3.1.3.3. Analysis of Real Water Samples	56
3.2. Determination of Manganese	57
3.2.1. Calibration plots for Mn(II) and Mn(VII) with FAAS	57
3.2.2. Studies for Sorption and Speciation of Mn(II) and Mn(VII)	58
3.2.2.1. Sorption	58
3.2.2.2. Extraction Efficiency as a Function of pH	62
3.2.2.3. Desorption Studies	64
3.2.2.4. Total Recovery of the Proposed Method	
for Mn Determination	65
CHAPTER 4 CONCLUSION	67
REFERENCES	69

LIST OF FIGURES

Figure 1.1. Steps in microcolumn field sampling	5
Figure 1.2. The schematic of FIA	10
Figure 1.3. A simple single-line FIA manifold	11
Figure 1.4. Eh-pH diagram of antimony in the Sb-S-H ₂ O system	14
Figure 1.5. Eh-pH diagram of Mn-CO ₂ -H ₂ O system	21
Figure 2.1. Segmented Flow Injection (SFI)–HGAAS system used in Sb determinations	24
Figure 3.1. Effect of HCl concentration on Sb(III) signal	37
Figure 3.2. Effect of NaBH ₄ (m/v) concentration on Sb(III) signal	38
Figure 3.3. Effect of carrier gas flowrate on Sb(III) signal	39
Figure 3.4. Absorbance signals for Sb(V) using KI as a pre-reduction agent.	41
Figure 3.5. Absorbance signals obtained from Sb(V) after certain periods following pre-reduction with 5% (m/v) KI	41
Figure 3.6. Absorbance signals for Sb(V) using L-cysteine as a pre-reducing agent.	43
Figure 3.7. Calibration curves of Sb(III) and Sb(V).	44
Figure 3.8. Effect of presence of 0.05 M KIO ₃ in calibration standards	45
Figure 3.9. Percentage uptake of Duolite GT-73 chelating resin for Sb(III) and Sb(V) as a function of pH and acidity	50
Figure 3.10. Calibration curves of aqueous and matrix-matched standards for Mn(II) and Mn(VII)	57
Figure 3.11. Percentage uptake of Amberlite XAD-7HP and Duolite C-467 resins for Mn(II) and Mn(VII) as a function of pH	60
Figure 3.12. Percentage uptake of Diaion SK 1BS, Diaion SK 116 and Dowex 50WX4 resins for Mn(II) and Mn(VII) as a function of pH	60
Figure 3.13. Percentage uptake of Amberlite 120 plus, Diaion SA 20 A and Dowex 1X4 resins for Mn(II) and Mn(VII) as a function of pH	61
Figure 3.14. Percentage uptake of Amberlite IRA 743 and Amberlite IRN 78 resins for Mn(II) and Mn(VII) as a function of pH	61
Figure 3.15. Percentage uptake of Amberlite XAD-7HP resin for Mn(II) and Mn(VII) as a function of pH	62

LIST OF TABLES

Table 2.1. The temperature program for ETAAS measurements of Sb.	25
Table 2.2. Properties of the sorbents used in Mn speciation at pH 3.0, 7.0, and 10.0	34
Table 3.1. Absorbance signals obtained from investigated pre-reduction agents	42
Table 3.2. Sorption of Sb(III) and Sb(V) with selected sorbents	46
Table 3.3. Elution of sorbed Sb(III) from the sorbents	47
Table 3.4. Recovery results for ultra-pure water	51
Table 3.5. Recovery results for bottled-drinking water	51
Table 3.6. Recovery results for sea-water	51
Table 3.7. Recovery results for tap water	51
Table 3.8. Spike recovery results for Sb(III) and Sb(V) with ultrapure water.	53
Table 3.9. Composition of the SRM used in the study.	54
Table 3.10. Results obtained for SRM solution.	55
Table 3.11 Recovery results obtained for synthetic SRM solution.	55
Table 3.12. Results obtained from bottled drinking water samples using the proposed methodology.	55
Table 3.13. Sorption of Mn(II) and Mn(VII) towards selected sorbents.	59
Table 3.14. Percent sorption of Mn species at different pH values.	63
Table 3.15. Desorption of Mn species from Amberlite XAD-7HP.	65
Table 3.16. Percent recovery of the proposed methodology.	65

ABSTRACT

A selective separation/preconcentration method utilizing microcolumn of a chelating resin with –SH functional groups (Duolite GT-73) was proposed for the determination of Sb(III) in waters by segmented flow injection HGAAS. The selectivity of the resin towards Sb(III) and Sb(V) was not dependent on the pH of the solution; Sb(III) was retained by the resin quantitatively in a broad pH and acidity range whereas Sb(V) was not retained at all and could be determined after a pre-reduction step with L-cysteine. Spike recoveries were tested at various concentration levels in different water types and were found to vary between 80-110 %. Accuracy of the proposed methodology was checked by analyzing a standard reference material and a good correlation was found between the determined and the certified values. The method was applied to several bottled drinking water samples for antimony determination. The samples were found to contain no antimony above the permissible level (5 µg/L). The applicability of the microcolumn separation/preconcentration method for flow injection systems was also demonstrated.

A similar separation system was proposed for Mn determination in waters. A macroporous resin with no functional groups (Amberlite XAD-7HP) was employed for the speciation of Mn(II) and Mn(VII) and was found to retain Mn(VII) at pH values from 4.0 to 12.0. Mn(II) was retained at a pH of 12.0, possibly due to MnO₂ precipitation rather than adsorption by the resin.

ÖZ

Sulardaki Sb(III)'ün kesikli akış enjeksiyon hidrür oluşturmali atomik absorpsiyon spektrometri ile tayin edilebilmesi için -SH fonksiyonel gruplara sahip kelatlayıcı reçine (Duolite GT-73) içeren bir mikrokolonlu ayırma/önderiştirme metodu önerilmiştir. Reçinenin Sb(III) ve Sb(V)'e olan seçiciliğinin çözelti pH'sından bağımsız olduđu, Sb(III)'ün geniş bir pH ve asitlik aralığında tutulduđu halde Sb(V)'in hiç bir pH'da tutulmadığı ve L-cysteine ile bir indirgeme basamağından sonra tayin edilebileceği belirlenmiştir. Katma (spike) geri kazanma deneyleri, farklı su örnekleri ve çeşitli derişimler ile test edilmiş ve sonuçların % 80-110 arasında değıştığı bulunmuştur. Önerilen metodun doğruluđu bir standart referans madde ile kontrol edilmiş ve belirlenen derişim sertifikalı değere yakın bulunmuştur. Metot, çeşitli içme sularına uygulanmış ve hiç birinde izin verilen değerin üzerinde (5 µg/L) Sb derişimine rastlanmamıştır. Söz konusu mikrokolon ayırma/önderiştirme metodunun akış enjeksiyon sistemlerine uygulanabilirliği gösterilmiştir.

Sulardaki Mn tayini için benzer bir ayırma sistemi önerilmiştir. Bu amaçla Mn(II) ve Mn(VII) türlemesinde herhangi bir fonksiyonel grup içermeyen Amberlite XAD-7HP reçinesi kullanılmıştır. Reçinenin, kantitatif olarak, Mn(VII)'yi pH 4-12 aralığında, Mn(II)'yi ise pH 12'de tuttuđu gözlenmiştir. Mn(II)'nin tutunmasının reçine üzerinde adsorpsiyondan çok MnO₂ çökmesi ile oluştđu belirlenmiştir.

CHAPTER 1

INTRODUCTION

1.1. The Philosophy of Trace Analysis

Trace analysis can be defined as an analytical procedure requiring special steps to be taken because of the low levels of the analyte in the sample. This may involve precautions in handling to minimize contamination, the extensive purification of reagents or the use of instrumentation near to the limits of its performance. A long time ago, concentrations around mg/L levels were called as “trace”. Nowadays, concentrations from $\mu\text{g/L}$ to ng/L levels (or even lower) are considered as trace. However, it is very difficult to specify an element as trace. One element which is at high concentration in one sample can be trace amount in another one.

There are several sources of trace elements in nature both natural and anthropogenic. Natural sources include the weathering of rocks, volcanoes, sea spray, thermal springs, lake and river sediments, vegetation and forest fires. Inputs from anthropogenic sources are from metal mining and smelting, combustion of coal, oil and wood, industrial operations, waste disposal, agricultural activities. It is often difficult to assign the source or sources of trace elements to a particular location and sometimes too much emphasis is given to anthropogenic sources. Volcanic activity is a significant source of several trace elements, for example, Br, Se and Sb. The main source of Zn may be a smelter, a power station, a volcano; fertiliser production, vegetation or motor tyre wears, depending on the nearness of the sampling location to the source. It has been reported that, concentrations of many elements in some environmental samples have appeared to drop by orders of magnitude. The authors state that this is due to the improvements in sample handling and analytical instrumentation rather than real drop in concentration [1].

Trace analysis, or analysis in general, can be considered to include several steps. These are sample collection (if the analysis is not being carried out *in situ*), storage and transportation of sample to the laboratory, preparation for the measurement, calibration of the instrument (if an instrumental determination is necessary), measurement, data analysis and reporting. One of the major problems in the analysis is the contamination of the sample during collection, in storage, transport and during the analysis. This requires several measures to be taken to prevent contamination. Many natural water samples might be among the most difficult matrices to analyze for their trace element contents. The extremely high concentrations of alkali and alkaline earth halides in seawater for example, make direct analysis by most of the analytical techniques difficult or impossible. Because of very low levels of the trace elements (0.02-10 µg/L), contamination problems become extremely important. Serious changes in the liquid sample can occur during the storage due to contamination by the container material, loss by adsorption on the container walls, contamination by desorption of previously adsorbed ions from the walls. Adsorptional losses also play a very important role in filtration for removing the suspended metal ion [2]. So, careful storage of samples and their transport is very important. It is common practice to acidify water to the pH<2 at the time of collection, in order to reduce possible loss of elements by adsorption onto the walls of containers or to freeze the samples [3].

A number of basic prerequisites must be considered for accurate working procedures which naturally apply to the same degree for all non-polluted waters. Firstly, it is recommended to use all containers exclusively for trace analysis. They are thoroughly cleaned prior to first use generally with nitric acid and checked regularly for blank values. Secondly, the reagents are of the highest purity and are used in the smallest possible volumes. Thirdly, if possible, all steps are carried out in a clean room, or at least in a dust free environment to minimize contamination from the laboratory atmosphere or from dust. In addition, on-line procedures in closed systems are superior to all manual batch procedures due to the significantly lower risk of contamination and to their much better repeatability and reproducibility [4].

Depending on the sensitivity required in the quantitation step, generally two approaches are followed in trace element determinations. The first strategy is to use or develop special measurement systems which are capable of detecting the low concentrations of certain species directly in the sample. Instrumental developments have produced an increasing number of methods suitable for trace element determinations without an enrichment step. For example, graphite furnace atomic absorption spectrometry (GFAAS) [5], hydride generation atomic absorption spectrometry (HGAAS) [6] and in recent years inductively coupled plasma mass spectrometry (ICP-MS) [7] have been extensively used in the determination of trace metals in the samples either directly or after a matrix separation step. The second strategy in trace analysis is to use some preconcentration methods to increase the concentrations of the analytes to a measurable level using available techniques. Meanwhile, the analyte is usually separated from the interfering components.

The preconcentration technique used most widely and for the longest period of time for trace elements in fresh waters and seawater is liquid-liquid extraction. Another very effective preconcentration procedure is coprecipitation. An advantage of this technique is the possibility of preconcentrating a large number trace elements at the same time; one disadvantage is the longer times and effort required and that considerable experience is necessary.

In recent years solvent extraction and coprecipitation have been increasingly replaced by sorbent (solid phase) extraction and ion exchange. In solid phase extraction the components of the sample are distributed between the sample phase and a sorbent material. The sorbent material is a solid in which the sample components are bound by a variety of mechanisms, including adsorption, ion exchange, complex formation etc. The common procedure involves preconditioning of the sorbent with a proper eluent to convert it into a known form and then allowing the conditioned stationary phase to equilibrate with the sample. Use of solid phase extraction systems markedly lower the quantity of reagents required and this feature is frequently quoted as an advantage, although this is strongly method dependent. A further advantage is that the solid phase is packed into a column and can thus be used repeatedly for reversible reactions.

Preconcentration utilizing solid sorbents can be performed in two distinct forms, namely the batch and the column methods. In the batch mode, a quantity of the sorbent is added to the sample and the mixture is then shaken for a prespecified period. If the conditions are suitable, the analytes of interest become bound to the sorbent which are then separated from the sample solution by filtration. The batch method is considered to suffer from a number of drawbacks including: (i) the efficiency with which the analyte binds to the sorbent is often low because of equilibrium effects; (ii) the sample volume is usually large; (iii) the reaction time must be adjusted whenever the composition of the sample changes; (iv) the sorbent must be cleaned thoroughly to eliminate contamination of the sample.

In view of the drawbacks mentioned above, preconcentration is normally carried out in the column mode. Here, the sorbent is packed into a suitable column through which a volume of sample is passed. The dimensions and nature of the column will vary with the type of the sample and will range from very simple devices, such as a Pasteur pipet, to special purpose disposable columns and even microcolumns. Column preconcentration can be performed either off-line or on-line. In the former case, the sample is passed through a suitable column after which the enriched analyte is desorbed from the column with an eluent. The resultant solution is analyzed by an appropriate procedure. In the on-line method, the sorbent column is coupled directly to the analytical instrument so that the sample enrichment, desorption, and determination steps can be carried out at the same time automatically.

For field sampling, several types of sorbents can be used depending on the aim of the study. The silylated silica gel columns, chelating cellulose filters and membrane adsorptive filters are reported to be the most satisfactory [8]. These sorbents can even be used for on-line preconcentrations at the natural pH without requiring any previous addition of chemicals. In the ion-exchange methods, the column is packed with an ion-exchange material which shows selectivity towards desired ions. In chelating resins, the stationary phase consists of a ligand bound to a suitable support. These phases can give complexation reactions and they have been used widely for trace enrichment of metal ions from natural waters. In addition to the feasibility of their use at field applications, column methods have many advantages over other preconcentration methods. They are simpler to use, less time consuming than solvent extraction and allow much higher

concentration factors to be attained. In addition to these, the sample is not contaminated with heavy metal impurities from buffers, organic reagents used for extraction and chemicals used for co-precipitation.

Enrichment procedures utilizing mini or microcolumns of various solid sorbents have broadened the range of applications of separation and preconcentration methods. Especially incorporation of microcolumns in a flow injection system has been the method of choice for many applications [9,10,11,12]. Microcolumns have also several advantages over the other preconcentration methods; they include the use of moderate sample volumes (5-100 mL) rather than applying relatively large amounts of samples (> 1L); they are suitable for field sampling and the transportation of the microcolumns to the laboratory is easy and the preservation of the analyte species in their original forms (matrix isolation, separation) is possible. During field sampling, water samples are processed in flow systems at the sampling site and trace elements of interest are immobilized on microcolumns. The microcolumns can be eluted right after the deposition step at site or later in the laboratory (off-line elution). They can also be inserted into the FI system for on-line elution (Figure 1.1) [13].

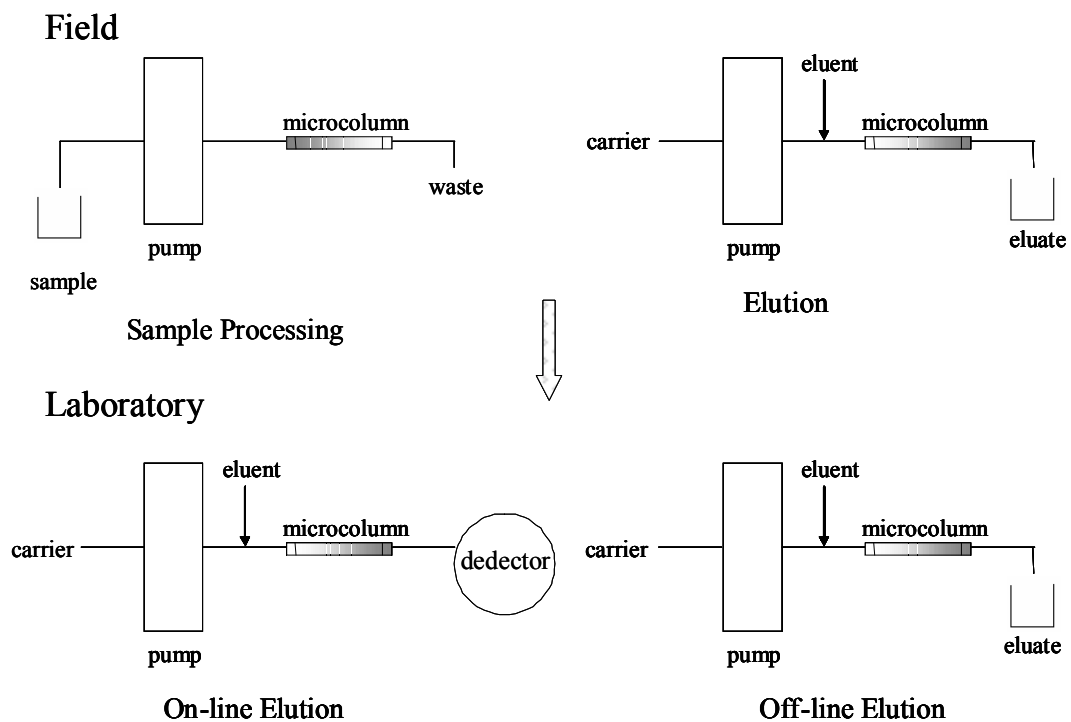

Figure 1.1. Steps in microcolumn field sampling.

1.2. Speciation of Trace Elements in Waters

The importance of knowing that a given element occurs in different physico-chemical forms in various natural matrices has been widely recognized in the last years. In the past a large proportion of all inorganic analyses have involved the measurement of the total quantity of an element. In order to bridge the gulf between methods, which give the total amount of an element in a sample, and the methods, which give full structural information on the chemical form of the element, the concept of “speciation analysis” has been developed.

Speciation of an element is the determination of the individual physico-chemical forms of that element which together make-up its total concentration in a sample. Speciation analysis is described as a measurement, which gives qualitative and/or quantitative information on the chemical form of the element.

Different chemical forms of an element may exhibit different reactivity, toxicity and bioavailability. One of the key issues of speciation analysis is to preserve the composition of the sample and the species of interest during sampling, sample storage and pretreatment, such as dissolution, extraction and preconcentration. Any treatment that would result in a shift of equilibria or in a destruction or transformation of one species into another must carefully be avoided.

Speciation analysis mostly involves two steps: separation and determination. The success of such a procedure is limited by difficulties in taking into consideration all kinetic factors, adsorption processes, polymerization reactions and heterogeneous processes [14]. There are many speciation analyses which are possible for any particular element and the chosen method must be well matched to the requirements of the particular scientific study. The most difficult problem encountered in speciation is to develop a procedure, which does not disturb the chemical equilibria between forms of the element existing in a given matrix. In addition, to avoid excessive preconcentration, only the most sensitive detectors are suitable for speciation analysis [15].

1.3. Hydride Generation Atomic Absorption Spectrometry (HGAAS)

One of the most sensitive techniques that can be employed in the determination of a group of elements is hydride generation atomic absorption spectrometry. Covalent hydrides are a series of compounds whose elements are the C, N and O groups where the number of valency electrons is equal to or greater than the number of orbitals. These elements include As, Al, B, Bi, Ge, P, Pb, Se, Sb, Sn, Te and Ti. Of these thirteen elements, eight have been induced to form covalent hydrides in sufficient amounts to be of practical analytical use; these are As, Bi, Ge, Pb, Sb, Se, Sn and Te. Such a procedure enhances the detection limits by a factor of 10 to 100. Because several of these species are highly toxic, their determination at low concentration levels is of considerable importance. This toxicity also dictates that gases from atomization must be disposed of in a safe and efficient manner. The basic design of a hydride generation system with subsequent atomic absorption may conveniently be considered to consist of four steps: First, generation of hydride; second, collection of the hydride (if necessary); third, transfer of the hydride to the atomizer; and fourth, decomposition of the hydride to the gas-phase metal atoms within the optical axis of the atomic absorption spectrophotometer. The measured atomic absorption signal is directly proportional to the number of free metal atoms per unit optical axis cross-section at a given instant. In order to increase this signal, it is necessary to generate the hydride quickly, or collect it and then transfer it as quickly as possible to the atomizer. This reduces dilution of the hydride by the carrier gas.

Basic methodologies about the generation of covalent hydrides have been described in a major review paper by Godden and Thomerson [16]. Various reducing agents and sources of nascent hydrogen have been suggested in order to convert the element of interest into its hydride. The Marsh reaction, using zinc metal and dilute hydrochloric acid or sulphuric acid, was the most frequently used.

A mixture of dilute hydrochloric acid, potassium iodide solution, tin (II) chloride solution (using the dilute hydrochloric acid solution as the solvent) and granular zinc metal has been described. This appears to give a faster reaction time as no collection metal, or carrier gas, was found to be necessary.

Pollock and West concluded that the above mixture was not suitable for the generation of the stibine (SbH_3) from solutions containing antimony (III). However, they found that a magnesium-hydrochloric acid-titanium (III) chloride medium was entirely satisfactory. The advantage of this reduction mixture is that it can be also used for the determination of Bi and Te.

The use of sodium borohydride reported by Schmidt is a landmark in the development of the technique. A typical hydride generation reaction is given below with As(III) as the analyte and NaBH_4 as the reductant. This reaction shows that the reaction medium must be strongly acidic in order to produce the hydride [17].

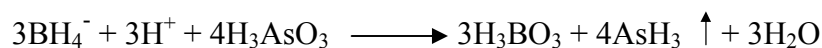

The sodium borohydride method offers several advantages over the other reduction methods. The reaction of an analyte species with aqueous sodium borohydride is most frequently employed to yield a volatile hydride which can be readily removed from the bulk matrix. This results in the isolation of the analyte from interferences and gives a species which can be readily concentrated and separated from other species.

After the generation of the hydride, it is transferred directly to the atomizer by means of plastic connection tubes. There is generally no need to collect the liberated hydride by using different collection devices namely, liquid nitrogen trap, balloon method etc.; but liquid nitrogen trap can be used for the speciation and it also offers further increase in the sensitivity. If collection device is used, it will be placed between the hydride generation vessel and the atomization unit.

Air-acetylene and argon-hydrogen flames are most widely used flames in the hydride generation method. With an air-acetylene flame as an atom reservoir, one of the primary difficulties encountered was the presence of 60% absorbance of the flame. A quartz tube mounted on the flame reduced the flame absorption. There are number of studies related to matrix interferences in atomization techniques. Electrically heated quartz tubes can also be used for atomization. Flame-heated quartz tube atomizers are cheaper to acquire than electrically heated quartz tube atomizers but more expensive to run. The

silica tube is mostly mounted in a holder that allows it to be moved into the flame. It should be remembered that the flame-heated quartz tube atomizers cause the devitrification of the silica tube since the flame is hot or oxidizing. The analyte hydrides are normally introduced at the center of the heated quartz tube. The tube length and diameter have a complex influence on the analyte signal and on interferences due to concomitants.

1.4. Flow Injection Analysis (FIA)

Flow injection analysis was defined by first Ruzicka and Hansen as “A method based on injection of a liquid sample into a moving unsegmented continuous stream of a suitable liquid. The injected sample forms a zone which is then transported toward a detector that continuously records the absorbance, electrode potential, or any other physical parameter, as it continuously changes as a result of the passage of sample material through the flow cell” [18]

Later, in the second edition of the book, flow injection has been defined as “Information-gathering from a concentration gradient formed from an injected, well defined zone of fluid, dispersed into a continuous unsegmented stream of a carrier.”

The concept of FIA after its introduction has become an accepted and versatile technique for solution handling and information gathering [18,19] and has created a revolution in analytical methodology directed at automation, miniaturization and mechanization of routine operations. Main features of FIA include good precision, ease of automation and sample throughput.

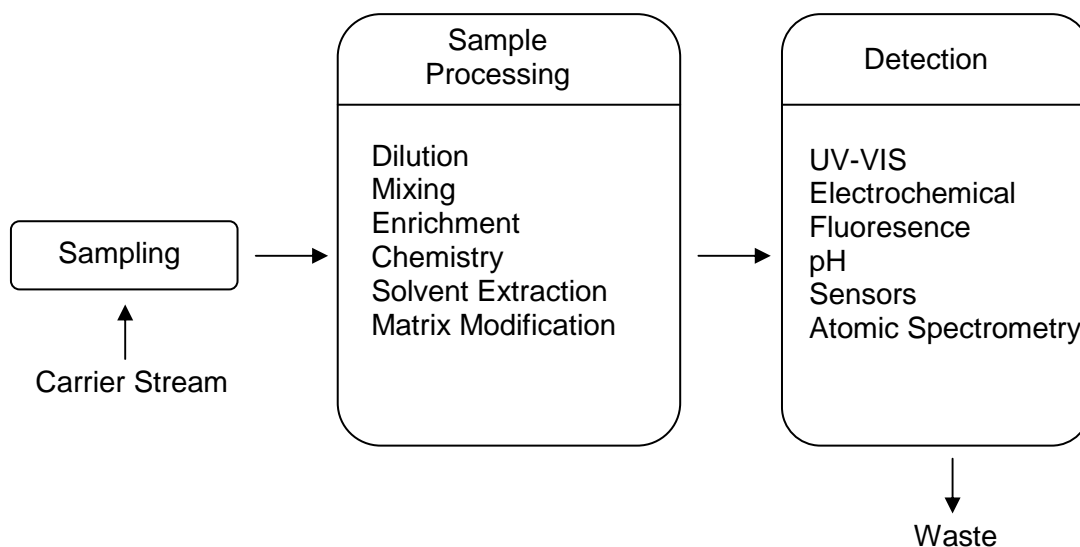

Figure 1.2. The schematic of FIA.

Figure 1.2 indicates the flow injection analysis process into three stages to help visualize how the technique performs a method or analysis. Flow injection analysis is based on a combination of three principles: sample injection, controlled dispersion of the injected sample zone, and reproducible timing of its movement from the injection point toward and into the detector. The first step consists of sampling where the sample is measured out and injected into the flowing carrier stream. The purpose of the second stage is to transform the analyte into a species that can be measured by the detector and manipulate its concentration into a range that is compatible with the detector using one or more of the indicated processes. The third stage is detection where the analyte generates a signal peak which is used for quantitation. FIA can be applied to a variety of tasks ranging from pH or conductivity measurement, to colorimetric titrations and enzymatic essays. To design a FIA system properly, one must consider the desired function to be performed. Thus FI methods have been developed for UV-VIS absorption spectrophotometry, molecular luminescence and a variety of electrochemical techniques (including potentiometry and voltammetry) as well as for the various atomic spectrometric techniques [13]. The power of FIA as an analytical tool lies in its ability to combine these analytical functions in a wide variety of different ways to create a broad range of methodologies and perform these automatically with relatively small amounts of sample.

A basic FI system consists of a pump, usually a peristaltic pump due to its high versatility, which is used to propel the carrier stream through a narrow tube; an injection port where a well-defined volume of sample solution is injected into the carrier stream in a reproducible manner; and a reactor in which the sample zone disperses and reacts with the components of the carrier stream, forming a species that is sensed by a flow-through detector and recorded (Figure 1.3).

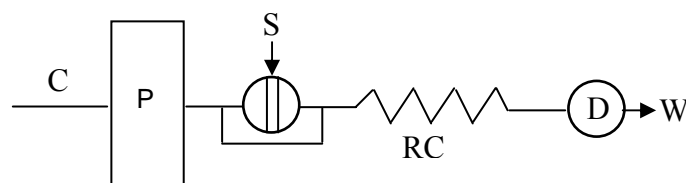

Figure 1.3. A simple single-line FIA manifold. C, a carrier stream of reagent; S, injection port; RC, reaction coil; D flow cell; W waste.

Flow injection analysis can also be used for separation and preconcentration which exhibit some favorable features over batch preconcentration. The technique is easier to operate than other separation methods and the equipment is more robust where it also offers a broad range of choices for different sorbents, complexing systems and eluents. The general merits can be summarized below:

- High sample throughput, 1-2 orders of magnitude higher than batch procedures with short operation times typically in the range of 10-200 s per determination (including separations)
- High enrichment efficiencies for preconcentration systems, typically a factor of 5-50 higher than batch procedures.
- Low sample consumption, 1-2 orders of magnitude lower than batch procedures. This is a feature important for valuable samples; such as blood, or for samples which have to be transported to the laboratory from distant collection sites.
- High reproducibility; typically in the range of 1-3 % rsd.
- Simple automated operation, which allows implementation with continuous monitoring systems and use in process control.
- Low contamination risks owing to closed and inert separation systems used, a feature important in trace analysis.

- Possible enhancement in selectivity by applying kinetic discrimination.
- Very limited laboratory bench space required.

Flow injection analysis is also a versatile sample introduction system for atomic spectrometry. In general, atomic spectrometric determinations suffer from several interference effects. Usually these effects arise from the components of the sample as it is constituted after preparation and pretreatment. FI procedures are used in conjunction with atomic spectrometry for the following purposes;

- Automated micro-sample introduction system. The use of discrete sample volume injection provides improved tolerance to high dissolved solids, organic solvents, and variable viscosity. Flow injection analysis also provides on-line dilution and a suitable means of handling slurried samples.
- Automated preconcentration with direct coupling to the spectrometer. Retention of the analyte on a solid phase extractant followed by dissolution in a clean matrix is the most implemented technique. This also provides separation of the analyte from potentially interfering matrix components.
- Automated implementation of chemical vapor generation procedures (hydride generation or cold vapor systems). There are significant advantages to the use of a FI procedure instead of a batch procedure. For example, the interferences by first row transition metals (such as copper and nickel) are considerably decreased. In addition to coupling with the normal quartz tube atomizer, this FI method may be readily coupled with a graphite furnace atomizer.

1.5 Antimony

1.5.1. Antimony in Nature

Antimony is a naturally occurring element. Its geochemical behavior is similar to arsenic, so it is commonly associated with nonferrous deposits and is emitted to the environment during the smelting of these ores. Antimony is used in semiconductors for making infrared detectors and diodes. The presence of antimony greatly increases the hardness and the mechanical strength of lead. Batteries, antifriction alloys, type-metal, small arms and tracer bullets are the main products containing antimony. Antimony trioxide, Sb_2O_3 has many uses including as a flame-proof retardant of textiles, papers, plastics and adhesives; as a paint pigment, ceramic opacifier and catalyst. Antimony tetroxide, Sb_4O_8 is used as an oxidation catalyst for the dehydrogenation of olefins [20].

Antimony can exist in a variety of oxidation states (-III, 0, III, V) but it is mainly found in two oxidation states (III and V) in environmental, biological and geochemical samples. Antimony and its compounds are considered as pollutants of priority interest by the Environmental Protection Agency of the United States [21] and the European Union [22]. The USEPA drinking water standards are: maximum contaminant level goal (MCLG) and maximum contaminant level (MCL), are both $6 \mu\text{g/L}$ [23] The European Union established a maximum admissible concentration of antimony in drinking water of $5 \mu\text{g/L}$ [24] Typical concentrations of dissolved antimony in unpolluted waters are less than $1 \mu\text{g/L}$. The mean antimony concentration in surface marine waters is $184 \pm 45 \text{ ng/L}$. However in the proximity of anthropogenic sources, higher concentrations can be found [20].

Antimony has no known biological function and like arsenic, it is toxic. Trivalent species are reported to be more toxic than pentavalent forms [25]. These two forms exhibit pronounced differences in their analytical behavior, toxicity and mobility. Because the pentavalent antimony appears to be the predominant species in most environmental waters, it is insufficient to determine only the total amount of antimony in a given sample for estimating its physiological or environmental risks. There are more than 3000 organic antimony compounds described in literature, only two organic

species are present in natural waters (methylstibonic acid and di-methyl-stibinic acid), which are less toxic than inorganic forms [26].

According to thermodynamic equilibrium, antimony exists as Sb(V) in oxic systems and as Sb(III) in anoxic ones [27]. The redox behavior of elements like antimony can be illustrated by Eh-pH diagrams. Figure 1.5 shows an Eh-pH diagram for the system Sb-S-H₂O at environmentally relevant concentrations for antimony concentration of 10⁻⁸ mol/L and a dissolved sulfur concentration of 10⁻³ mol/L. According to this diagram, it is stated that antimony is present as soluble Sb(OH)₆⁻ in oxic systems and as soluble Sb(OH)₃ in anoxic ones at natural pH values. Under reducing conditions, and in the presence of sulfur, stibnite, Sb₂S₃(s), is formed at low to intermediate pH values. At higher pH values, the Sb₂S₄²⁻ species replaces stibnite.

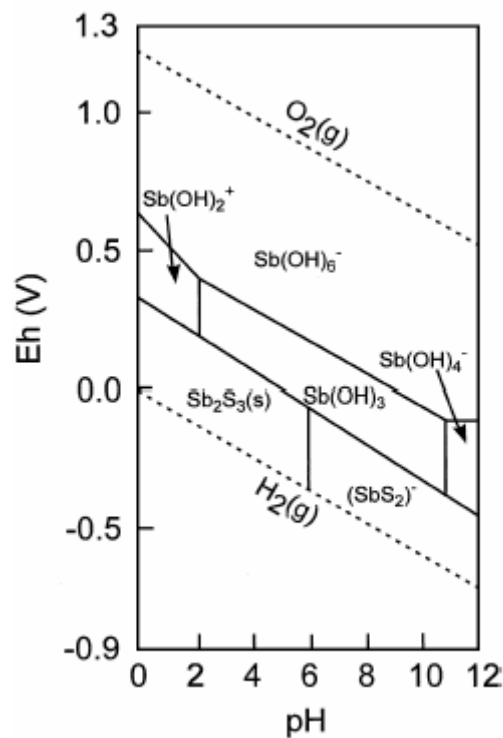

Figure 1.4. Eh-pH diagram of antimony in the Sb-S-H₂O system at a dissolved antimony concentration of 10⁻⁸ mol/L and a dissolved sulfur concentration of 10⁻³ mol/L [27].

1.5.2. Antimony Speciation

It is nowadays well recognised that the understanding of biogeochemical processes depends upon the knowledge of the chemical forms, or species, that are present in the natural environment. Despite this well-known requirement, the speciation of many elements in the natural environments is not adequately known. Antimony is not an exception. As mentioned in the previous section, antimony occurs in two oxidation states in natural waters and, thus, its behaviour can be affected by changes in the redox status of the aquatic environment. In natural water speciation studies, a rapid and reliable separation technique coupled with a suitable detection system is required. The samples should be analyzed as soon as possible after collection without use of sample preservation techniques such as acidification, which will modify the natural equilibria of species present.

Many workers have performed the speciation of Sb(III) and Sb(V) and determined their concentrations with a subsequent detection system. Wang et al. [28] have performed a potentiometric stripping analysis with a thin-film gold electrode for the determination antimony. Ariza et al. [29] described a procedure for the separation and the determination of inorganic species of antimony based on the use of coupled high performance liquid chromatography (HPLC) hydride generation (HG) atomic fluorescence spectrometry (AFS). Sb(III) and Sb(V) were separated on a miniaturized anion exchange column using ammonium tartrate aqueous solution at pH 6.9 as eluent. Dingman et al. [30, 31] have synthesized a polydithiocarbamate resin and tested it with Sb(III) using AAS. Andreae et al. [32] have determined Sb(III) and Sb(V) in natural waters by HGAAS where Sb(III) was selectively reduced at near-neutral pH whereas Sb(V) was not reduced. Sb(III) and Sb(V) were reduced together to stibine under highly acidic conditions in a solution containing iodide. Sturgeon et al. [33] have used GFAAS after chelating Sb(III) with ammonium pyrrolidine dithiocarbamate and subsequent adsorption on C₁₈ bonded silica gel. Kamada et al. [34] have investigated many chelating agent-solvent couples for the selective determination of Sb(III) and Sb(V) by AAS with a carbon-tube atomizer. Han-wel et al. [35] have performed selective separation and differential determination of Sb(III) and Sb(V) by solvent extraction with N-benzoyl-N-phenyl hydroxylamine and GFAAS using a matrix modification technique. Sato [36] has shown that Sb(III) reacts easily with mandelic acid to form a

complex anion which is extractable into chlorobenzene with malachite green from acidic media at room temperature.

Besides the use of the other techniques for speciation, chelating resins were also used for the same purpose. Sugawara et al. [37] have reported the immobilization of 8-hydroxyquinoline on controlled pore glass beads. This was done using γ -amino propyl triethoxysilane which was bound to the glass via a silylation reaction. Leyden et al. [38] have carried out a similar procedure to immobilize a variety of functional groups on both silica gel and glass beads. Yu et al. [39], in one of the landmark studies in this field, have investigated the use of cotton impregnated with thioglycolic acid for the separation of various oxidation states of arsenic antimony, selenium and tellurium. They have stated that adsorptive power of thiol cotton depends on the oxidation state of the element considered and generally lower oxidation states are readily absorbed whereas the higher states are not.

Recently, an increasingly attractive research area for antimony speciation has been the development of hyphenated techniques, i.e.; the on-line combination with suitable element specific detectors of modern separation techniques such as GC, HPLC, CE. These coupled techniques permit the simultaneous separation and determination of Sb(III) and Sb(V) as well as organoantimony species. Gürleyük et al. [40] demonstrated that an organic salt (potassium antimonyltartrate) and an inorganic salt (potassium hexahydroxyantimonate) of antimony are reduced and methylated biologically to Me_3Sb by micro-organisms. This was confirmed by matching retention time of the compound in GC, as detected by fluoride-induced chemiluminescence, with a commercial standard, and by its mass spectrum determined by GC-MS.

1.5.3. Methods for Antimony Determination

There are many methods for the determination of antimony in various samples. Conventional methods such as gravimetry and volumetry can be used when the concentration of antimony is relatively high. For example Sb(III) can be titrated with standard triiodide solution in iodimetric method [41]. Potentiometric stripping analysis was also used for the determination of Sb(III) with a thin-film gold electrode [28]. Spectrophotometric determination of Sb(III) can be carried out after complexing it with some complexing agents such as mandelic acid and malachite green [36] and chromium (VI) solution [42]. Due to simultaneous multielement determination capability, X-ray fluorescence spectrometry is a well-known technique especially if more than one element is to be determined [43]. Atomic fluorescence spectrometry is another useful technique for antimony determination [44]. Neutron activation analysis (NAA) is a very sensitive technique for determining antimony especially when coupled with hydride generation [45]. Of all inductively coupled plasma mass spectrometry (ICP-MS) [44] and atomic absorption spectrophotometry (AAS) [47, 48, 49] are the most useful and the most sensitive techniques with some modifications, for the determination of antimony.

Using atomic absorption spectrometry, antimony can be determined in the air-acetylene flame practically free of interferences. However, little has been published about the determination of this element by FAAS since it is mostly present in very low concentrations and must therefore be determined using more sensitive techniques. Antimony can be determined by GFAAS under stabilized temperature platform furnace (STPF) conditions and using the Pd-Mg modifier [Reference No.4 and the related references therein]. Concentrations of NaCl of up to 30 g/L is reported to have no influence on the Sb signal under these conditions. Solely, sulfate contents of >20 mg/L cause a slight gas-phase interference, which can nevertheless be largely eliminated by optimizing the thermal pretreatment condition [Reference No.4 and the related references therein]. Antimony can be determined with advantage by HGAAS. The atomization signal is nevertheless dependent on the oxidation state and the hydride system used. In batch systems Sb(III) generates a signal that is nearly twice as high as that for the same mass of Sb(V). In flow systems this difference can be more than one order of magnitude, depending on the reaction zone. These differences are also pH

dependent; this offers the possibility, for example, of selectively determining Sb(III) at pH 8 in the presence of a large excess of Sb(V) [Reference No.4 and the related references therein].

For the determination of total antimony content it is nevertheless necessary to perform a prereduction to ensure that all of the antimony is present as Sb(III). A solution of potassium iodide in hydrochloric acid is frequently used for this purpose. However we must consider that the high acid concentration and also the potassium iodide pose a substantial disposal problem. In addition, potassium iodide solutions only have limited stability. For this reasons L-cysteine is highly recommended as the reductant; investigated by Welz and Sucmanova . The major advantages of this reagent are that it is virtually non-toxic, it is fully effective in acid concentrations of only 1 mol/L, and the solutions are stable for several weeks. Moreover, interferences caused by transition metals especially copper and nickel, can be far more effectively avoided with L-cysteine than with potassium iodide [Reference No.4 and the related references therein].

1.6 Manganese

1.6.1. Manganese in Nature

Manganese is a very abundant element in nature with an average concentration in natural waters in the range 0.1-1.0 mg/L. It can be found in various samples such as soils, surface and ground waters in the +1 through +7 oxidation states [4]. Manganese is an essential micro-nutrient that is present in all living cells. Its presence is essential for the proper function of several enzymes and is an essential micro-nutrient for the function of the brain, nervous system and normal bone growth [50]. It is used in various steel materials as a hardening agent and also finds application in pharmaceutical preparations. However, it is toxic at high levels and can cause lesions, headache, psychotic behavior, drowsiness and other related symptoms and/or diseases [50]. It is known that excessive intake of Mn^{2+} affects human health. In public water supplies, MnO_4^- causes such difficulties as the staining of clothes and encrustation of mains. However, although manganese is of little direct toxicological significance, with the exception of the purple-colored permanganates which have bactericidal properties, it may have a protective effect and control the concentrations of other elements, including toxic heavy metals in surface waters.

The current World Health Organization (WHO) guideline for manganese levels is 0.5 mg/L for health and 0.1 mg/L to avoid staining problems [51]. The limit value for Mn in drinking is 50 μ g/L according to both EU and USA regulations [4].

Many methods have been used to determine manganese, including spectrophotometry, polarography, neutron activation analysis (NAA), atomic absorption spectrometry (AAS) [52] and inductively coupled plasma atomic emission spectrometry (ICP-AES).

The standard method of determination of manganese is described in US EPA Method 7460. The determination is based on the measurement of absorption signal at 279.5 nm with an air-acetylene flame of an AAS. Background correction is required, and quantification is done using matrix matched standards or standard addition method. Although atomic spectrometric methods can be applied for the direct determination of

elements in most circumstances, several preconcentration techniques are still necessary especially for environmental samples. For example a chelating poly(dithiocarbamate) resin (PDTC) has been proposed by Yebra-Biurrun et al. [53] for the preconcentration of manganese and determination by flame atomic absorption spectrometry. However, this technique is rather time-consuming and requires a large number of samples. Teo and Chen used [50] cloud point extraction for the preconcentration of manganese, after the formation of a complex with 1-(2-thioazolylazo)-2-naphthol (TAN) and determined by flame atomic absorption spectrometry using octylphenoxypolyethoxyethanol (Triton X-114) as surfactant. Yebra et al. [54] extracted manganese on-line from solid seafood samples by a simple continuous ultrasound-assisted extraction system which is connected to an on-line manifold of a flow-injection flame atomic absorption spectrometry.

1.6.2. Manganese Speciation

The behavior and the forms of Mn in waters can be predicted from its Eh-pH diagram (Figure 1.5). Redox conditions and the acidity/alkalinity existing in the solution have a direct influence in Mn speciation. According to Figure 1.5, the expected form of Mn in most natural waters is the hydrated Mn^{2+} ion. This prediction is also supported by various studies [55,56,57,58]. In oxygenated waters and high pH, MnO_2 is likely to be the predominant form. Although Mn^{2+} is expected to be readily oxidized especially at high pH waters, the rate of this oxidation has been reported to be very slow and meta-stable Mn^{2+} may persist for some time in oxic water [Reference No.57 and the related references therein]. Because of this reason, Mn studies in natural waters have generally been concentrated on the determination of Mn^{+2} .

Qian et al. [52] described a novel method for the speciation and preconcentration of Mn(II)/Mn(VII) with crosslinked chitosan (CCTS) and determination by flame atomic absorption spectrometry. Özdemir et al. [59] developed a speciation scheme for the identification of the chemical forms of manganese in tea leaves and tea infusions. A speciation method was developed to study distribution of copper and manganese species in cow milk by Aceto et al [60]. The method is based upon solid-phase extraction of selective fractions of the analytes, followed by elution and determination by inductively coupled plasma-atomic emission spectrometry (ICP-AES) [58].

A palmitoyl quinolin-8-ol (P.Ox) functionalized Amberlite XAD-2 copolymer resin (XAD-P.Ox) was used by Dođutan et al. [58] in the column mode to preconcentrate

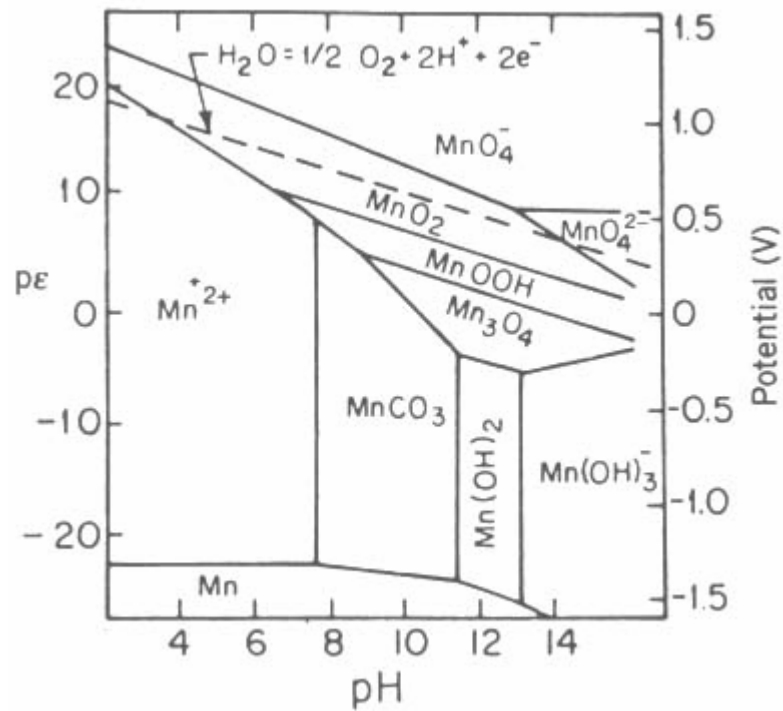

Figure 1.5. Eh-pH diagram of Mn-CO₂-H₂O system (25°C). The solid phases are considered are Mn(OH)₂(s) (pyrochroite), MnCO₃(s) (rhodochrosite), Mn₃O₄(s) (hausmannite), γ -MnOOH(s) (manganite) and γ -MnO₂(s) (nsutite). $c_{\text{T}} = 10^{-3}$ M and $\text{Mn}_{\text{T}} = 10^{-5}$ M [55]

trace Mn(II) from artificial and real seawater, and Mn in the eluate was determined by the formaldoxime (FAD) spectrophotometric method. The results compared with those of FAAS. Speciation studies of dissolved and particulate manganese have been performed by Ouddane et al. [57] in order to establish a model for manganese behaviour in the Seine river estuary. A sequential extraction procedure was applied to assess the manganese distribution in solid samples where ETAAS was used for the determinations.

1.7. Aim of This Work

One of the important research fields in analytical chemistry is the development of reliable and practical methods for the speciation and determination of trace elements in environmental samples.

The purpose of this study is to develop a microcolumn-flow injection system for the determination of Sb(III) and Sb(V) in waters including drinking water. For this purpose, chelating resins and natural and synthetic zeolites were tried as sorbents and their selectivity towards Sb(III) and Sb(V) were examined. The efficiency of the sorbent was studied as a preconcentration agent and then was examined by recovery studies. The samples prepared using the mentioned methodology was analyzed by hydride generation atomic absorption spectrometry (HGAAS) since this technique is one of the most sensitive techniques in Sb determinations. Availability of atomic absorption spectrometry in our laboratory was another factor in choosing this method. Several important parameters in HGAAS technique such as the concentration of the acid used, concentration of NaBH_4 reagent, concentration of the pre-reducing agent, etc. that affect the sensitivity for the determination of antimony were examined.

A similar system was investigated for the determination of manganese (Mn) and initial results were obtained. Manganese concentrations were determined by flame AAS.

CHAPTER 2

EXPERIMENTAL

2.1. Chemicals and Reagents

All reagents were analytical grade. 18 MΩ ultra pure water was used throughout the study. Glassware and plasticware were cleaned by soaking them in dilute nitric acid (10%) and rinsed with distilled water prior to use.

1. Standard Sb(III) stock solution (1000 mg/L): Prepared by dissolving 1.408 g of potassium antimony tartrate ($C_4H_4KO_7Sb$) in 500 mL ultra pure water.
2. Standard Sb(V) stock solution (1000 mg/L): Prepared by dissolving 1.116 g of potassium antimonate ($KSb(OH)_6 \cdot \frac{1}{2} H_2O$) in 500 mL ultra pure water.
3. Standard Mn(II) stock solution (1000 mg/L): Prepared by dissolving 0.275 g of manganese sulfate ($MnSO_4$) in 100 mL ultra pure water.
4. Standard Mn(VII) stock solution (1000 mg/L): Prepared by dissolving 0.287 g of potassium permanganate ($KMnO_4$) in 100 mL ultra pure water.
5. Calibration Standards: Lower concentration standards were prepared daily from their stock standard solutions.
6. Sodium borohydride solution (1% m/v): Prepared daily and stabilized by the addition of 0.1% (m/v) NaOH.
7. pH adjustment: Various concentrations of HCl, NaOH and $NH_3 \cdot H_2O$ solutions were used.

2.2. Instrumentation

An atomic absorption spectrometer, Thermo Elemental Solaar M6 Series with an air-acetylene burner assembly was used for the measurements. Antimony determinations were performed with HGAAS whereas FAAS was used in Mn determinations. ETAAS was also applied in some experiments. In sorption studies with batch process, Yellowline RS 10 orbital shaker was used to provide efficient mixing. The manifold for off-line separation/preconcentration system utilized a Gilson Miniplus 3 and/or Ismatec 834 model peristaltic pump with either Tygon or PVC tubings of various diameters. The pH measurements were performed by using Corning 450 pH/ion meter with a pH combination electrode.

2.2.1. HGAAS for Sb

The hydride generation system coupled with segmented flow injection unit (FI 90) was used in all measurements for antimony determinations (Figure 2.1). It is a continuous HG system segmented with air bubbles. Antimony hollow cathode lamp operated with a maximum current of 10 mA at 217.6 nm and deuterium (D_2) background correction was used in all measurements. The monochromator slit was kept at 0.5 mm.

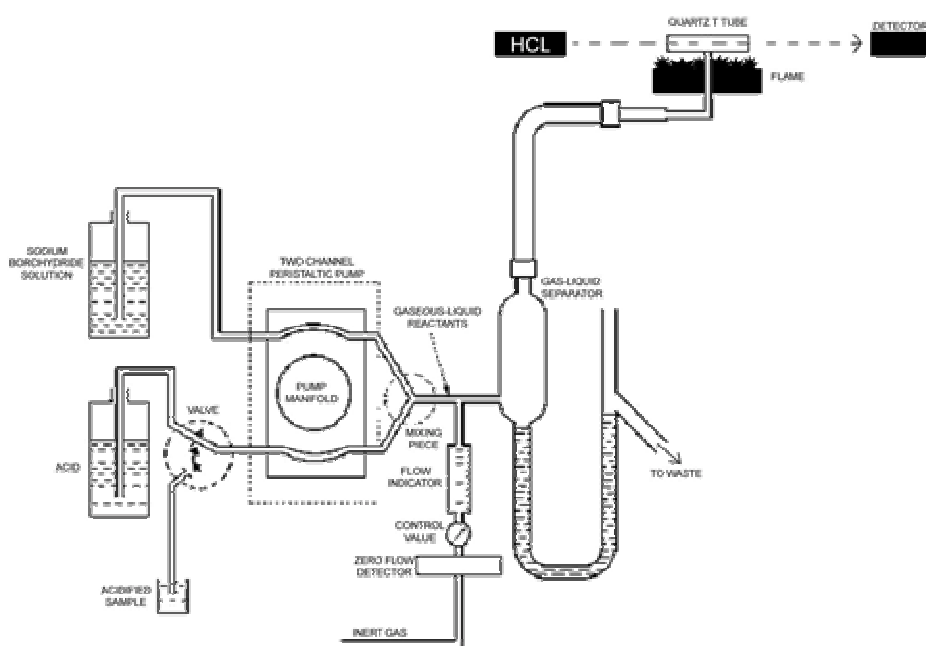

Figure 2.1. Segmented Flow Injection (SFI-HGAAS) system used in Sb determinations.

In HGAAS, the quartz tube atomizer was 10 cm long, 8 mm in internal diameter and 10 mm in external diameter with a 4 mm bore inlet tube fused at the middle for the introduction of stibine. Air-acetylene flame was used for heating the quartz tube externally and nitrogen was used as the carrier gas.

2.2.2. FAAS for Mn

For manganese determinations flame atomic absorption spectrometry was used with the manganese hollow cathode lamp (a maximum current of 12 mA at 279.5 nm) and deuterium (D₂) background correction. The monochromator slit was kept at 0.5 mm. Air-acetylene flame was employed under the conditions recommended by the manufacturer.

2.2.3. ETAAS for Sb

Electrothermal atomic absorption spectrometry (ETAAS) was applied as a supplementary technique to HGAAS for the comparison purposes. The temperature program is given in Table 2.1.

Table 2.1. The temperature program for ETAAS measurements of Sb.

Step	Temperature (°C)	Heating Rate (°C/s)	Hold Time (s)
Drying	100	10	45
Ashing	800	150	30
Atomization	2200	0	3
Clean	2500	0	3

2.3. Determination of Antimony

2.3.1. Optimization of HGAAS Parameters for Sb Determinations

The sensitivity of the method is influenced by several factors such as the carrier gas flowrate, the concentrations of acid, NaBH₄ and pre-reducing agent, etc. These parameters were optimized. In the SFI 90 system, the standby delay, stabilize delay and baseline delay periods were applied as 20, 40, 40 seconds respectively as recommended by the operators manual.

2.3.1.1. Sb(III) Signal

2.3.1.1.1. Effect of HCl Concentration

The first parameter was the acidity of the sample since hydride generation strongly depends on the acid concentration. Among various acids HCl has been almost universally accepted and therefore it was used throughout the study. The change in absorbance signal of 40.0 µg/L solution of Sb(III) as a function of HCl concentration from 0.06 M to 2.4 M was examined.

2.3.1.1.2 Effect of NaBH₄ Concentration

It is known that the sensitivity of the system is affected also by the concentration of NaBH₄. So, it is important to find the optimum concentration of NaBH₄ solution due to the need to obtain the maximum signal and for economical reasons. For this purpose, 40.0 µg/L solutions of Sb(III) in 0.12 M HCl were analyzed with different concentrations of NaBH₄ solution from 0.1-5% (m/v) and the absorbance signals were obtained.

2.3.1.1.3. Carrier Gas Flowrate

The carrier gas flowrate used to transport stibine into quartz T-tube (atomizer tube) was also optimized. To obtain the optimum flowrate, 40.0 µg/L of Sb(III) solution was prepared in 0.12 M HCl and analyzed by SFI-HGAAS using 0.12 M HCl as the carrier solution and 1%(m/v) NaBH₄ as the reductant at different flowrates from 100 mL/min to 500 mL/min.

2.3.1.2. Sb(V) Signal

The difference between the absorbance signals obtained from trivalent and pentavalent antimony depends very strongly on the system used and experimental conditions. Since Sb(V) gives very low signal in HGAAS systems, the reduction of Sb(V) to Sb(III) is needed. Because of this reason, the reduction process was also optimized.

2.3.1.2.1. Pre-reduction of Sb(V) to Sb(III)

For the initial stages of the study several pre-reduction agents such as potassium iodide, tartaric acid, citric acid, tartaric or citric acid mixed with potassium iodide, L-cysteine in 5% (m/v) and 4 M HCl (heating at 80-100 °C) were examined using 40.0 µg/L Sb(V) solution. As a result, L-cysteine was decided as the pre-reduction agent for the further periods of the study. So, the concentration of the L-cysteine from 1-5% (m/v) was also optimized using the same concentration of Sb(V).

2.3.1.3. Calibration Curves for Sb(III) and Sb(V)

In order to plot the calibration curves of Sb(III) and Sb(V), standard solutions from 5.0 µg/L to 60.0 µg/L were prepared in 0.12 M HCl and the absorbance signals were obtained by SFI-HGAAS using 0.12 M HCl as the carrier solution and 1%(m/v) NaBH₄ as the reductant.

2.3.2. Speciation and Preconcentration of Sb(III) and Sb(V) using Solid Sorbents

In the initial stages of the study, preconcentration and speciation of antimony were performed both with microcolumns and through batch type process.

2.3.2.1. Sorption

2.3.2.1.1. Batch Type

In order to find the appropriate sorbent for the speciation of Sb(III) and Sb(V), various adsorbents such as chelating resins, natural and synthetic zeolites were tried. As an initial experiment, 500 µg/L solutions of Sb(III) and Sb(V) were prepared from their stock solutions separately. The pH of the solutions was adjusted to 7.0 since the pH of the natural waters lies generally between 6.0 and 8.0. About 0.1 g sorbent was added immediately after the addition of stock solutions in order not to be affected from possible conversions. The solution was shaken manually for 1-2 minutes and then placed on the shaker for 15 minutes. The contents were filtered through filter paper and the filtrate, after acidification, was measured by SFI-HGAAS using the optimum conditions.

2.3.2.1.1.1. Types of Sorbents

As mentioned above, to find the suitable sorbent for the speciation and preconcentration of antimony species, several adsorbents such as chelating resins, natural and synthetic zeolites were investigated. The properties of the sorbents used are given below:

a) Zeolites: A group of naturally occurring aluminosilicates, which have a porous molecular framework structure. The regularly spaced pores allow some molecules to pass into and through the crystal lattice while keeping others outside (molecular sieving). Such physio-chemical properties give zeolite high cation exchange, gas absorption and water retention capabilities. Throughout the study various zeolites, namely, clinoptilolite, zeolite beta, mordenite, zeolite Y and zeolite ZSM-5 were tried.

b) Chelating Resins

- **Amberlite IRC-718:** It has iminoacetic acid $[-\text{CH}_2-\text{N}(\text{CH}_2-(\text{COOH})_2]$ functional groups. It has high affinity for heavy metal cations over alkali or alkaline earth metals.
- **Chelex-100:** It also has iminoacetic acid functional groups. It is useful in concentrating or removing polyvalent cations from solution and it is also used in wastewater treatment.
- **Muromac A-1:** It resembles Chelex-100 resin with iminoacetic acid functional groups and which does not swell or shrink to an appreciable extent.
- **Duolite GT-73:** It is a macroporous resin with a crosslinked polystyrene matrix bearing thiol ($-\text{SH}$) functional groups.

2.3.2.1.2. Desorption from the Sorbents

After collection of Sb(III) on the sorbents, its release was investigated using several eluents. For this purpose, 50 mL of 40.0 $\mu\text{g/L}$ Sb(III) was prepared and 0.1 g of sorbent was added to it. After shaking for 15 minutes, the mixture was filtered and the sorbent was taken into the eluent. The new mixture was shaken once again for 15 minutes. At the end of this period, the solution was filtered and the eluate was analyzed for its Sb content.

2.3.2.1.3. Microcolumn Sorption

As explained in Introduction, another feature of this study is the use of microcolumns of the sorbent in the enrichment and speciation step. Therefore the subsequent experiments were concentrated on the microcolumns.

The manifold for off-line flow injection preconcentration utilized a peristaltic pump furnished with either Tygon or PVC tubings of various diameters and a packed microcolumn. Microcolumns were constructed from 1.5 mm i.d. PTFE tubings and filled with the Duolite GT-73 chelating resin (As it will be shown later, Duolite GT-73 chelating resin with its $-\text{SH}$) functional groups was used in Sb experiments). Small

pieces of sponge at both ends were used to keep the sorbent tightly packed and to prevent material losses. The sponge size was minimal so as not to cause any column back-pressure. Both ends of the columns and the packing is retained by inserting additional tubes connecting the microcolumn to peristaltic pump tubing. The column dimensions and physical characteristics of the resins are important parameters to be optimized. Therefore, several factors that would affect deposition and elution were also optimized.

2.3.2.1.3.1. Effect of Microcolumn Length

Microcolumns with the lengths of 1 to 10 cm packed with Duolite GT-73 chelating resin were prepared in order to obtain quantitative sorption. For this purpose, 40.0 µg/L Sb(III) solution was used. The standard solutions were passed through the microcolumns of different lengths and the percent sorption was determined by analyzing the effluents after acidification using 0.12 M HCl as the carrier solution and 1% (m/v) NaBH₄ as the reductant in SFI-HGAAS.

2.3.2.1.3.2. Effect of the Sorbent Particle Size

The sorbent particles having various diameters from 75 to 300 µm were packed into the PTFE tubings and the optimum particle size for microcolumn sorption was investigated using 40 µg/L Sb(III) solution. The solutions prepared were analyzed by SFI-HGAAS using 0.12 M HCl as the carrier solution and 1% (m/v) NaBH₄ as the reductant

2.3.2.1.3.3. Effect of Flowrate during Deposition and Elution in Microcolumns

It is known that sampling flowrate is an important factor for complete sorption on the resin. Therefore, several flowrates were tested in order to determine the optimum conditions for the sorption of Duolite GT-73 chelating resin. For this purpose, 40.0 µg/L solutions of Sb(III) were prepared and passed through the microcolumns at different flowrates from 0.5-5 mL/min. The effluents were analyzed using 0.12 M HCl as the carrier solution and 1% (m/v) NaBH₄ as the reductant in SFI-HGAAS. Subsequently, the flowrate of the eluent (0.05 M KIO₃ in 2M HCl) varied between 0.5-5 mL/min was also optimized.

2.3.2.1.4. Extraction Efficiency as a Function of pH

To understand the uptake behavior of Duolite GT-73 resin in a large pH range, separate solutions of Sb(III) and Sb(V) at 40.0 µg/L concentration were prepared in different buffer solutions from pH 1 to 10 at a constant ionic strength; and in different concentrations of HCl solution from 0.25 to 4 M. The percent sorption of the solutions was determined by the same procedure mentioned above. In these experiments; except the already acidified ones; the final solutions after shaking with or passing through the chelating resin were acidified with HCl to obtain a final concentration of 0.12 M.

2.3.2.1.5. Performance of Speciation and Preconcentration Steps

2.3.2.1.5.1. Preconcentration Ratio

Several waters including ultrapure water, bottled drinking water, tap water and sea water were used for recovery tests. In order to investigate the efficiency of Duolite GT-73 chelating resin in the enrichment of Sb(III) from different concentrations and different volumes (keeping the absolute amount constant), solutions at various volumes (20-2000 mL) and concentrations (20-0.2 µg/L.) were prepared. Meanwhile, the possible interference from the matrix of each type of water sample was checked. Appropriate amount of sorbent was added into each solution and the mixture was shaken as before. The same procedure was followed with an eluent volume of 20 mL. The preconcentration method proposed was also applied to the real water samples including tap water, sea water and bottled drinking water.

2.3.3. Method Validation

2.3.3.1. Recoveries with Sb(III) and Sb(V)

Recovery tests were performed using ultrapure water. Aliquots of sample were spiked with 20 µg/L Sb(III) and Sb(V) separately and applied to separate microcolumns of Duolite GT-73 resin. After loading the analyte, each microcolumn was washed with de-ionized water and then eluted with 0.05 M KIO₃ in 2 M HCl (As will be shown in the Results and Discussion, 0.05 M KIO₃ in 2 M HCl was used as the eluent). Blank

solution and the calibration standards were prepared using the same procedure. The so-called “recovered standard calibration curve” was used in quantitation. These standards prepared after sorption and elution can therefore be considered as the “matrix-matched standards”. The concentration of Sb in the eluates was determined by HGAAS and the percent recovery in each sample was calculated.

2.3.3.2 Performance of the Study

A standard reference material (SRM), Trace Elements in Natural Water (NIST, Cat. No 1640) was employed for method validation. As an initial study, to investigate the influence of the foreign ions coexisting in Standard Reference Material (SRM), a solution which is similar to SRM solution (synthetic SRM solution) was prepared. The effect of the sample matrix was studied in the volume range of 20-2000 mL. The experiments were performed to separate/preconcentrate spiked Sb(III) at concentrations from 0.2-20 μ g/L. The final volume of the solutions was 20 mL. Using the proposed methodology, the samples prepared were analyzed with HGAAS using 0.12 M HCl and 2% (m/v) NaBH₄. The results of the HGAAS method was tested by analyzing the same samples by ETAAS.

The subsequent study was concentrated on the determination of antimony content in standard reference material (SRM) using the proposed methodology. Ten milliliters aliquots of SRM were taken and processed by the proposed methodology; loading onto the Duolite GT-73 microcolumn and elution with KIO₃/HCl mixture. The eluates were analyzed by HGAAS and Sb concentrations were determined using the matrix matched standards.

2.3.3.3. Analysis of Real Samples

In order to apply the proposed method to bottled-drinking waters, several brands were collected; and analyzed for their Sb concentrations. To test the accuracy of the method once again, one brand was spiked with 15.0 and 30.0 μ g/L of Sb(III); and after the pre-reduction step, percent recovery was calculated by SFI-HGAAS using 0.12 M HCl as the carrier solution and 1%(m/v) NaBH₄ as the reductant.

2.4. Manganese Determinations

2.4.1. Calibration Curves for Mn(II) and Mn(VII)

Calibration standards from 0.01 to 2.5 mg/L were prepared in 0.14 M HNO₃ and analyzed by FAAS using the conditions recommended by the manufacturer. Standards prepared from MnSO₄ and KMnO₄ were also measured to check if they give different response. As in the case of Sb, the matrix-matched standards for Mn were prepared using the proposed sorption/elution steps with Amberlite XAD-7HP (As will be shown in Results and Discussion, this resin was used in sorption studies with Mn).

2.4.2. Speciation of Mn(II) and Mn(VII) using Solid Sorbents

2.4.2.1. Sorption

To find the appropriate sorbent for the speciation of Mn(II) and Mn(VII), experiments were performed with batch equilibration using various sorbents such as chelating and ion-exchange resins, natural and synthetic zeolites. As an initial study, 2.0 mg/L (20.0 mL) solutions of Mn(II) and Mn(VII) were prepared separately and the pH of the solutions was adjusted to 7.0. About 0.100 g sorbent was added immediately after pH adjustment. The solutions were shaken for about 15 minutes. The contents were filtered through filter paper and the filtrate was used for the determination of percent sorption using FAAS. (The details of the sorption experiments at pH 7.0 will be given in the Results and Discussion). Among the sorbents investigated some of them were selected for further studies (Table 2.2) In the subsequent experiment, the pH of the solutions was adjusted to pH 3.0, 7.0 and 10.0 to determine the approximate sorption in acidic, neutral and basic media. The percent sorption was examined using the same procedure mentioned above.

Table 2.2. Properties of the sorbents used in Mn speciation at pH 3.0, 7.0 and 10.0.

Sorbent	Property	Form
Diaion SK 116	Strong cation exchanger	sodium
Diaion SK 1BS	Strong cation exchanger	sodium
Diaion SA 20 A	Strong anion exchanger	chloride
Amberlite IRN-78	Strong anion exchanger	hydroxide
Amberlite IRA-743	Weak anion exchanger	free base
Amberlite IR 120 Plus	Strong cation exchanger	-
Dowex 1X4	Strong anion exchanger	chloride
Dowex 50WX4	Strong cation exchanger	hydrogen
Duolite C-467	Chelating resin	sodium
Amberlite XAD-HP	Adsorbent	-

2.4.2.2. Effect of Solution pH on Sorption of Mn(II) and Mn(VII)

To see the change in uptake behavior of the sorbent Amberlite XAD-7 HP in a wide pH range (2.0-12.0), 2.0 mg/L solutions of Mn(II) and Mn(VII) were prepared separately and the pH of the solutions was adjusted to the desired value using NaOH (0.1 M-1 M) and HCl (0.1 M-1 M). The percent sorption of the solutions was determined by the same procedure mentioned above.

2.4.2.3. Desorption from the Sorbents

After collection of Mn(II) and Mn(VII) on Amberlite XAD-7HP, the release from the resin was investigated using various eluents namely 2 M HNO₃, 2 M HCl, 0.02 M KI / 1 M HNO₃ and 0.01 M K₂C₂O₄ / 1 M HNO₃.

For this purpose, 2.0 mg/L 20.0 mL Mn(VII) solutions was prepared separately and the pH of the solutions were adjusted to 5.0. About 0.100 g of sorbent is added to the solutions. After shaking for 15 minutes, the solutions were filtered and the sorbents left on the filter paper were taken into the eluent solutions one by one. The solutions were

shaken again for 15 minutes for elution. After the end of this period, the solutions were filtered and the eluates were analyzed for their manganese content.

2.4.2.4. Recovery of the Proposed Method

In order check the total recovery of the method after sorption/elution stages, 15.0 mL of 2.0 mg/L for Mn(II), 15.0 mL of 2.0 mg/L Mn(VII) alone, 15.0 mL of 2.0 mg/L Mn(II) + 2.0 mg/L Mn(VII) together solutions were prepared separately and processed with the method. The final volume of the solution (0.01 M $K_2C_2O_4$ /1 M HNO_3) was also 15 mL. Percent recovery values were calculated from the matrix-matched calibration plots.

CHAPTER 3

RESULTS AND DISCUSSION

3.1. Determination of Antimony

3.1.1. Optimization of HGAAS for Antimony Determinations

Hydride generation methods have been widely used in atomic spectrometry due to their simplicity, high sensitivity and speciation capability. The technique has also been used in the determination of antimony in environmental samples usually after a suitable preconcentration step. Although the necessary conditions for Sb determination are given in these applications, initial studies in this work were still concentrated on the optimization of the HGAAS measurements since a different enrichment procedure and different chemicals were used. It is known that only Sb(III) gives an efficient signal in HGAAS; therefore, the optimizations were carried out only with standard Sb(III) solution. Optimization of HCl and NaBH₄ concentrations, carrier gas flowrate, pre-reducing agent concentration (for Sb(V)-to-Sb(III) conversion) etc. can be stated among these optimizations.

3.1.1.1. Sb(III) Signal

3.1.1.1.1. Effect of HCl Concentration

Generation of the hydride depends upon the acidity of the sample. In order to determine the acid concentration for optimum performance, 40.0 µg/L Sb(III) solution was prepared in various concentrations from 0.012 M to 2.4 M of hydrochloric acid and analyzed using HGAAS. Other acid matrices were not examined since hydrochloric acid is considered as the most convenient acid. As seen from Figure 3.1, almost a constant absorbance is obtained from the standard solutions having an HCl concentration between 0.06 M to 2.4 M.

The calibration standards were prepared in 0.12 M HCl throughout the study. (When the original HCl bottle with $d=1.19$ g/mL, 37% (v/v), is considered to be 100% (v/v), 0.12 M corresponds to 1% (v/v)). This property provided a convenience in solution preparation) As seen from Figure 3.1, there is minor signal suppression in hydrochloric acid concentrations higher than 0.12 M. This does not mean that higher acid concentrations cannot be used for the determination of the element. Sometimes even a 25%-50% decrease in the sensitivity is quite acceptable if interference-free analysis is possible. For instance, the use of higher acid concentrations has been suggested by some workers to lower the extent of interference due to an increase in the solubility of reduced metal species [61].

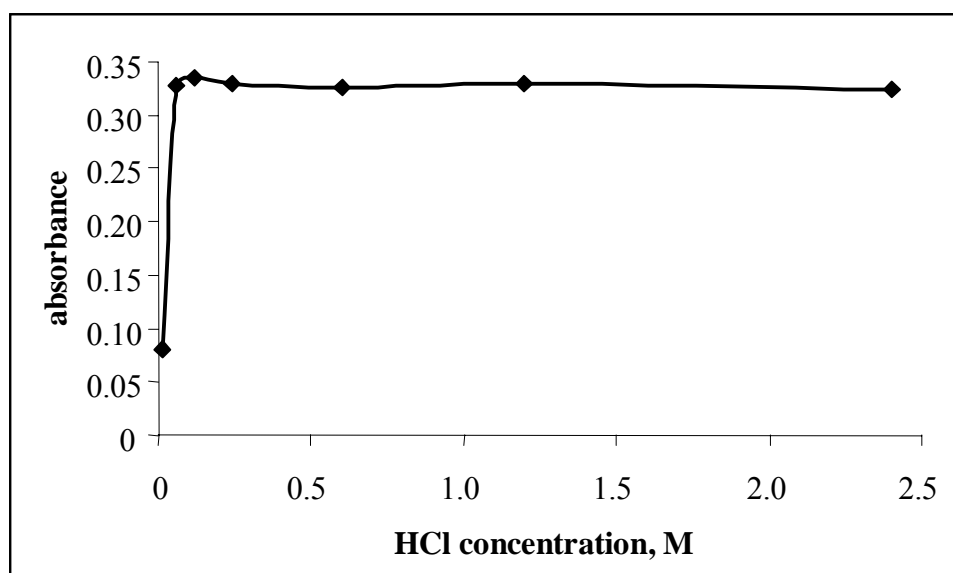

Figure 3.1. Effect of HCl concentration on Sb(III) signal. (40.0 $\mu\text{g/L}$ Sb(III), 1.0 % (m/v) NaBH_4 .)

3.1.1.1.2. Effect of NaBH₄ Concentration

It is known that the concentration of NaBH₄ has a direct effect on HGAAS system. So it is important to find the optimum concentration of NaBH₄ due to the need to obtain the maximum signal.

Figure 3.2 indicates the effect of NaBH₄ concentration on the absorbance signal of Sb(III). As seen, 1% (m/v) NaBH₄ gives the highest absorbance. Thus, 1% (m/v) NaBH₄ was used throughout the study unless stated otherwise. This result is also the best possible value due to economical reasons. Sodiumborohydride concentration higher than 1% (m/v) cause a decrease in the sensitivity. The reason for that is possibly the dilution of stibine (SbH₃) with large amount of H₂ gas produced during the reduction process.

It is recommended that the NaBH₄ solution should be prepared daily [4]. Some researchers mentioned that the solution was stable for several weeks if certain precautions were taken, e.g., if the NaBH₄ was dissolved in 2% (m/v) percent of sodium hydroxide solution and stored in a refrigerator at 4°C, or if the solution was filtered [4]. To be on the safe side, throughout the study, 1% (m/v) NaBH₄ was prepared daily and stabilized in 0.1 % (m/v) NaOH solution. Throughout the study if a cloudy solution is observed, it is filtered through filter paper prior to use.

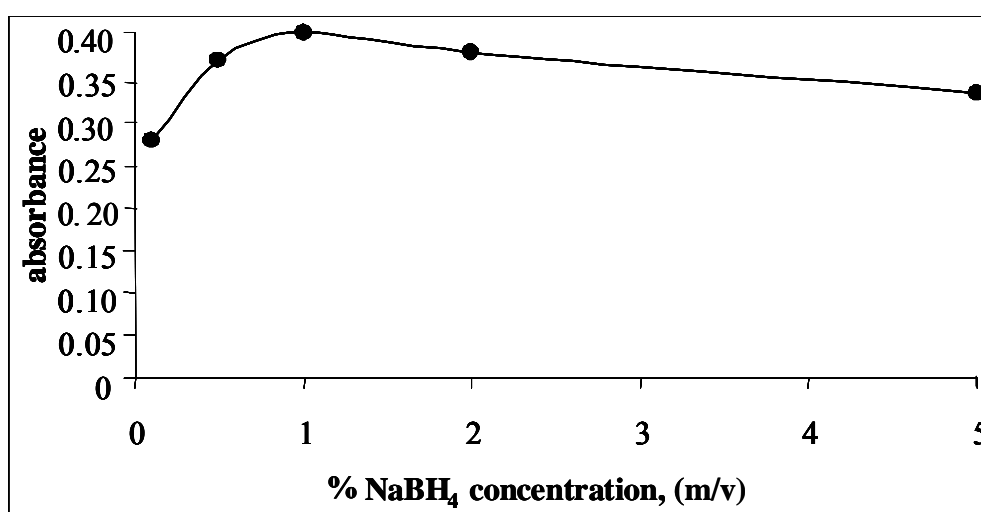

Figure 3.2. Effect of NaBH₄ (m/v) concentration on Sb(III) signal. (40.0 µg/L Sb(III), 0.12 M HCl.)

3.1.1.1.3. Carrier Gas Flowrate

The carrier gas flowrate is also an important parameter influencing the sensitivity, reproducibility and analytical throughput. Hence the carrier gas flowrate used to transport stibine to quartz atomizer was also optimized. For this purpose, 40.0 $\mu\text{g/L}$ of Sb(III) solution was prepared in 0.12 M HCl and analyzed using 1% (m/v) NaBH_4 solution at different flowrates from 100 mL/min to 500 mL/min. According to Figure 3.3, the maximum absorbance was obtained at a value of 200 mL/min and therefore this flowrate was used throughout the study.

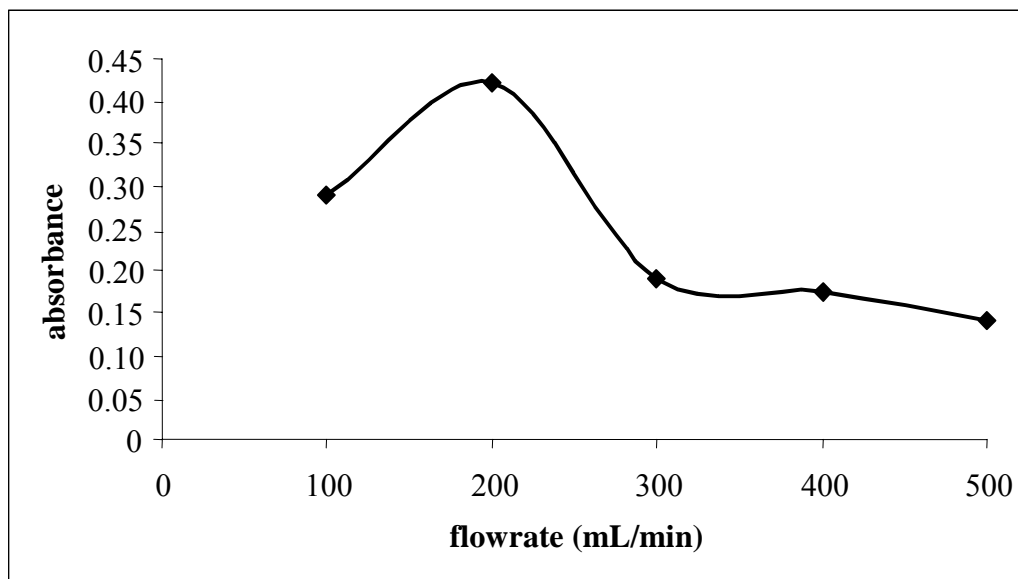
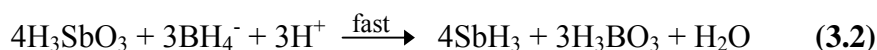
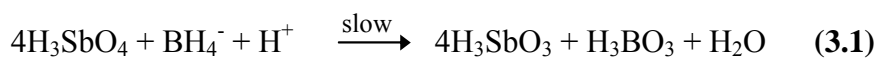

Figure 3.3. Effect of carrier gas flowrate on Sb(III) signal. (40.0 $\mu\text{g/L}$ Sb(III), 0.12 M HCl, 1%(m/v) NaBH_4).

3.1.1.2. Sb(V) Signal

Since Sb(V) cannot be completely reduced to stibine with NaBH₄, there is a need to pre-reduce Sb(V) to Sb(III). It also exhibits a very poor sensitivity compared to Sb(III). Stibine has been stated to occur through the following reactions [62]:



The second reaction reaction (3.2) is a fast reaction while the first (3.1) is extremely slow. Because the mixing time of sample solution with the sodium borohydride solution is very short in this hydride generation system, reaction (3.1) can be considered not to take place, this indicates the need for the reduction of Sb(V) solutions to Sb(III). To perform this reduction the use of potassium iodide either alone or mixed with ascorbic acid is suggested. L-cysteine is also proposed as an alternative reductant to potassium iodide [Reference No.4 and the related references therein].

3.1.1.2.1. Pre-reduction of Sb(V) to Sb(III)

Several pre-reduction agents are tried. starting with KI were tried to convert Sb(V) to Sb(III). Standard solutions of 40.0 µg/L Sb(V) are prepared and acidified with 0.12 M HCl. After the addition of KI from 0.5% to 5% (m/v), the solutions were analyzed analyzed by SFI-HGAAS using 0.12 M HCl as the carrier solution and 2%(m/v) NaBH₄ as the reductant. Figure 3.4 shows the absorbance signals of Sb(V) by HGAAS after a pre-reduction step with potassium iodide.

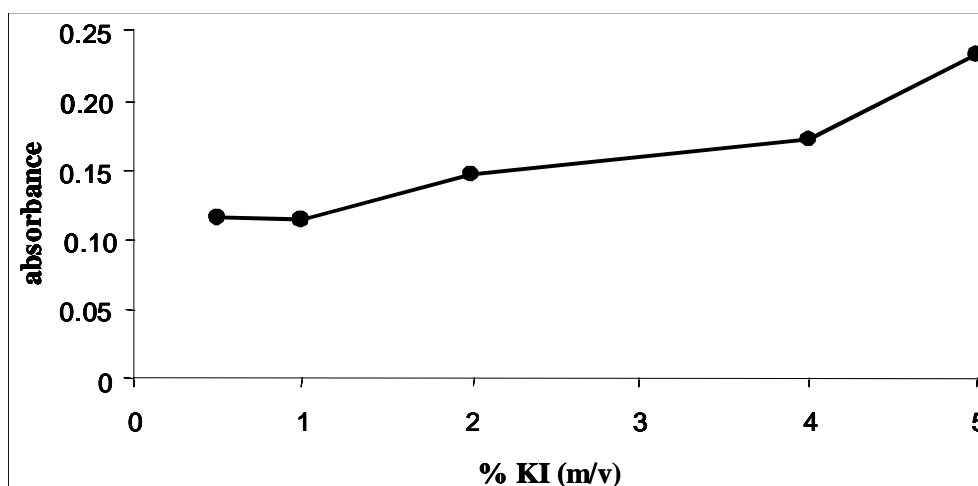

Figure 3.4. Absorbance signals for Sb(V) using KI as a pre-reduction agent (40.0 $\mu\text{g/L}$ Sb(V), 0.12 M HCl, 2% (m/v) NaBH_4 .)

It is important that the solutions be analyzed soon after the addition of the potassium iodide to prevent the formation of excess iodine in the acid solution which, otherwise, would interfere with the hydride generation step. Hence, 50.0 $\mu\text{g/L}$ standard solution of Sb(V) was prepared and analyzed at certain periods after the addition of 5% (m/v) KI.

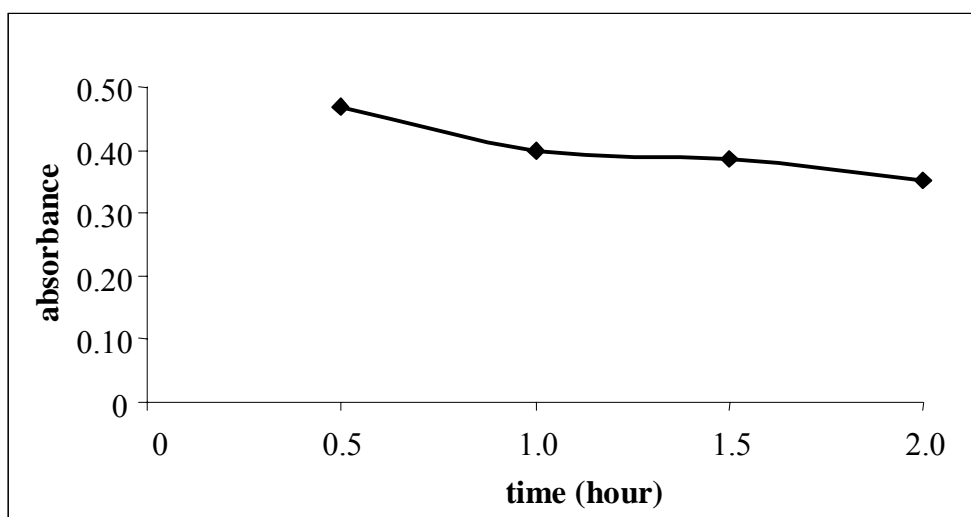

Figure 3.5. Absorbance signals obtained from Sb(V) after certain periods following pre-reduction with 5% (m/v) KI. (50.0 $\mu\text{g/L}$ Sb(V), 0.12 M HCl, 2% (m/v) NaBH_4 .)

Figure 3.5 shows the absorbance signals versus the stabilization time of Sb(V) in 5% (m/v) KI. As seen from the figure, when KI is added, the solutions should be analyzed in half an hour to avoid loss in sensitivity. This characteristic of KI solution, that is, its relative unstability can be considered as a disadvantage. Therefore, other reducing agents were tried in addition to KI. These were tartaric acid with/without KI, citric acid with/without KI, L-cysteine, and HCl (with a heating step). Their concentrations were 5% (m/v) as a starting point. Table 3-1 indicates the relative Sb(V) signals obtained from the examined reducing agents.

Table 3.1. Absorbance signals obtained from investigated reducing agents.

Pre-reduction Agents	Sb(V) Absorbance Signal
4 M HCl + heat	0.2606
5% (m/v) tartaric acid	0.2994
5% (m/v) citric acid	0.0345
5% (m/v) citric acid + 5% KI (m/v)	0.1578
5% (m/v) tartaric acid + 5% KI (m/v)	0.2456
5% (m/v) L-cysteine	0.3828

As seen from Table 3.1 the maximum signal is obtained from Sb(V) pre-reduced with L-cysteine. Although it is not given in the table, this result was confirmed also in subsequent studies. The mechanism of reduction of Sb(V) to Sb(III) with L-cysteine can be understood from the following reaction [62].

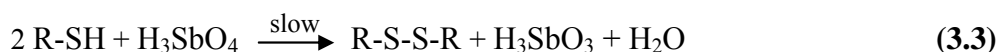

where R= -CH₂CH(NH₂)CO₂H.

L-cysteine can be applied at concentrations of 0.5 to 5% (m/v) with an HCl concentration of 0.1 to 1 M. Another advantage of L-cysteine is that it stabilizes the trivalent antimony for several days [4]. Figure 3.6 illustrates the optimization of L-cysteine concentration. As seen from the figure the highest signal was obtained with 2% (m/v) L-cysteine. Therefore L-cysteine with a concentration of 2% (m/v) was decided to be used in the subsequent experiments.

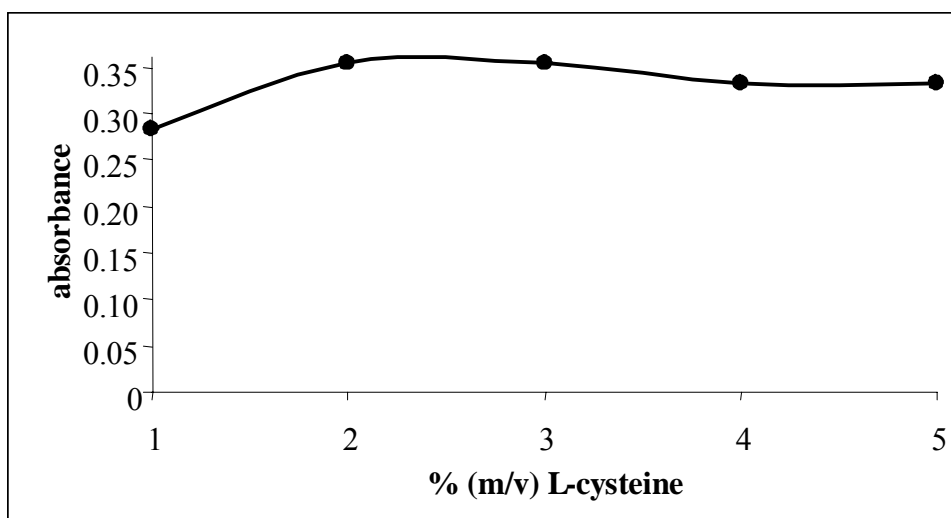

Figure 3.6. Absorbance signals for Sb(V) using L-cysteine as a pre-reducing agent. (40.0 $\mu\text{g/L}$ Sb(V), 0.12 M HCl, 1%(m/v) NaBH_4 .)

3.1.1.3. Calibration Curves for Sb(III) and Sb(V)

Absorbance versus concentration plots were obtained both for Sb(III) directly, and Sb(V) after a pre-reduction step with L-cysteine. The calibration plot for Sb(III) in 2% (m/v) L-cysteine was also obtained to examine the effect of the pre-reducing agent on the Sb(III) signal. As shown in Figure 3.7, all three calibration plots have very similar sensitivities and were linear at least up to 80.0 $\mu\text{g/L}$. The *characteristic concentration* (the concentration of the analyte corresponding to an absorbance of 0.0044) for Sb(III) without pre-reduction, and Sb(V) are 0.547 $\mu\text{g/L}$ and 0.383 respectively. The limit of detection (LOD) based on 3s (3 times the standard deviation above the blank value); for the above-mentioned calibration strategies were very similar. It is 0.298 $\mu\text{g/L}$ for Sb(III) after pre-reduction and 0.313 $\mu\text{g/L}$ for Sb(V).

An approximate number of 0.30 $\mu\text{g/L}$ was accepted as the limit of detection throughout the study.

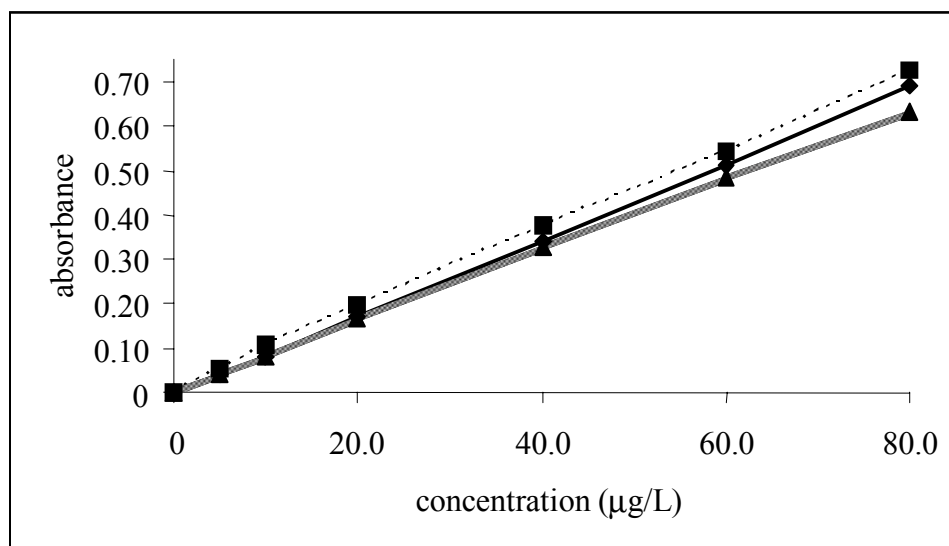

Figure 3.7. Calibration curves of Sb(III) and Sb(V). (■) Sb(III) without pre-reduction ($y= 0.099x + 0.0113$, $R^2= 0.9993$), (◆) Sb(III) in 2% (m/v) L-cysteine, ($y= 0.087x - 0.0031$, $R^2= 0.9999$), (▲) Sb(V) in 2% (m/v) L-cysteine; ($y= 0.0080x + 0.0030$, $R^2= 0.9997$), in all calibration plots 0.12 M HCl, 1% (m/v) NaBH_4 was used.

In the recovery studies, a so-called “recovered standard calibration plot” was applied for quantitation. These matrix matched standards were prepared in such a way that they were passed through the microcolumns of Duolite GT-73 and then the sorbed species were eluted using KIO_3/HCl solution. Also the concentration of NaBH_4 was increased from 1% (m/v) and 2% (m/v) NaBH_4 due to the strong oxidizing capacity of KIO_3 , which could suppress the signal (Figure 3.8). The calibration plots obtained with 1% (m/v) and 2% (m/v) NaBH_4 (all other parameters were kept constant) are shown in Figure 3.8. As seen, when 2% (m/v) NaBH_4 is used, the sensitivity approaches that of aqueous calibration plot.

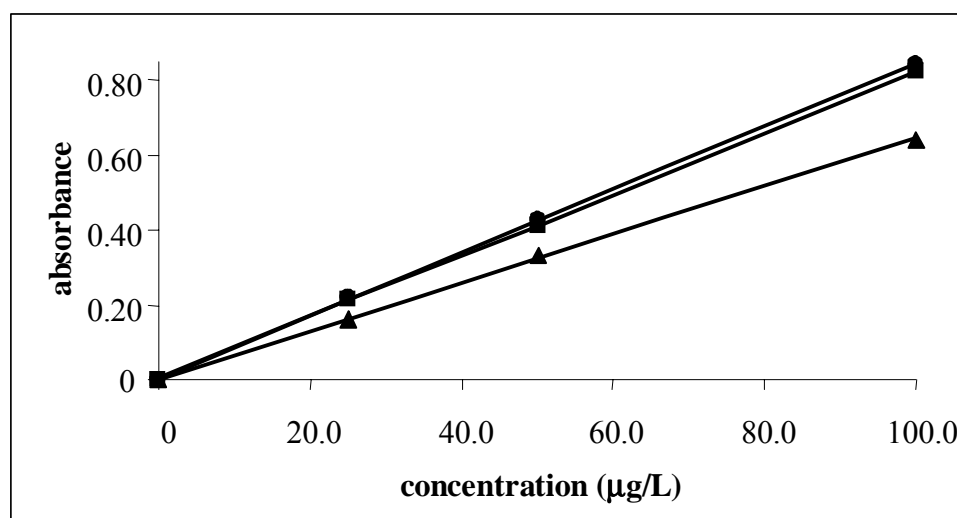

Figure 3.8: Effect of presence of 0.05 M KIO₃ in calibration standards. (in both calibration plots 0.12 M HCl were used.); (▲) 1 % (m/v) NaBH₄, (●) 2 % (m/v) NaBH₄, (■) aqueous calibration plot in 0.12 M HCl; 1 % (m/v) NaBH₄

3.1.2. Speciation and Preconcentration of Sb(III) and Sb(V) using Solid Sorbents

3.1.2.1. Sorption

3.1.2.1.1. Batch Type

Using batch process, the appropriate sorbent for the speciation of Sb(III) and Sb(V) was investigated. Several sorbents were tried as mentioned in Experimental. Standard solutions of Sb(III) and Sb(V) at a concentration of 500 µg/L were prepared from stock solutions separately. The pH of the solutions was adjusted to 7.0 since the pH of the waters generally lie between pH 6.0 and 8.0. About 0.100 g sorbent was added immediately after the addition of stock solutions. The mixture was shaken manually for 1-2 minutes and then placed on the shaker for 15 minutes. The contents were filtered through filter paper and the filtrate was used for the determination of percent sorption.

Table 3.2. Sorption of Sb(III) and Sb(V) with selected sorbents (initial study).
500 µg/L Sb(III), sample volume=20 mL amount of sorbent=0.100 g, pH=7)

Sorbents	% Sorption	
	Sb(III)	Sb(V)
Clinoptilolite	~ 35	-
Zeolite beta	~ 50	-
Mordenite	> 95	-
Zeolite Y	~ 45	-
Zeolite ZSM-5	~ 20	-
Muromac A-1	~ 10	-
Chelex 100	~ 10	-
Amberlite IRC-718	~ 85	-
Duolite GT-73	>95	-

Table 3.2 gives a rough idea about the uptake of selected sorbents towards Sb(III) and Sb(V) species. As can be seen, among the sorbents investigated, Mordenite, Amberlite IRC-718 and Duolite GT-73 offer significant results for the speciation of antimony at pH 7. However, Mordenite was not quite suitable in the study due to its small particle size; an inconvenient situation for low pressure microcolumn studies. Therefore, it was decided to carry on the further work with Duolite GT-73 resin which shows quantitative sorption towards Sb(III).

Duolite GT-73 is a macroporous resin with a crosslinked polystyrene matrix bearing thiol (-SH) functional groups. The suitability of mercaptosilica, a thiol-containing sorbent, to enrich As [8], Sb [63], Ge [64], Te [65] and Se [66] has also been shown previously. As seen from Table 3.2, Duolite GT-73 is selective for Sb(III) whereas Sb(V) is not taken up on the resin.

3.1.2.1.2. Elution from the Sorbents

It was thought that a reagent which would oxidize Sb(III) to Sb(V) could be used as the eluent solution due to the selectivity of Duolite GT-73 chelating resin only to Sb(III) but not to Sb(V). For this purpose, several oxidizing solutions namely $K_2Cr_2O_7$, KIO_3 , $KClO_3$, $KBrO_3$, $K_2S_2O_8$, KIO_4 , HNO_3 were prepared and examined for the recovery of Sb(III). Recovery studies were first performed using batch process. About 0.100 g Duolite GT-73 chelating resin was added to 20.0 mL of 50.0 $\mu\text{g/L}$ Sb(III) solution and the contents were shaken for 15 minutes for sorption. Then, the mixture was filtered through filter paper and the resin was taken into the eluent. The mixture was shaken for another 15 minutes and at the end of this period, the contents were filtered. The filtrate was acidified with 0.12 M HCl and was analyzed by SFI-HGAAS using 0.12 M HCl as the carrier solution and 2%(m/v) $NaBH_4$ as the reductant. Blank solution was also prepared by the same procedure. The eluent concentrations and the corresponding recoveries are given in Table 3.3.

Table 3.3. Elution of sorbed Sb(III) from the sorbents.

Eluent	% Recovery
0.05 M KIO_3 in 2 M HCl	> 99
0.05 M $KClO_3$ in 2 M HCl	~ 55
0.05 M KIO_4 in 2 M HCl	~ 70
0.05 M $KBrO_3$ in 2 M HCl	~ 50
0.05 M $K_2S_2O_8$ in 2 M HCl	~ 90
0.05 M $K_2Cr_2O_7$ in 2 M HCl	~ 65
10 % (v/v) HNO_3	< 10
10 % (v/v) HCl	< 5

As can be seen from Table 3.3, 0.05 M KIO_3 in 2 M HCl can be used efficiently as an eluent. This eluent worked very efficiently also in the microcolumn studies It eluted

sorbed Sb(III) species from the microcolumn easily. In addition, it was possible to quantify Sb(III) in KIO₃ solution directly without the need for pre-reduction step. This finding is also in accordance with a previous study [65]. Due to the oxidizing capacity of KIO₃, the concentration of the NaBH₄ was increased to 2% (m/v).

3.1.2.1.3. Microcolumn Sorption

In microcolumn field sampling, water samples are processed in flow systems at the sampling site and trace elements of interest are immobilized on microcolumns. The microcolumns may then be returned to the laboratory and directly inserted into a FI system for on-line elution and quantitative analysis. By means of microcolumns, more efficient, cost-effective and environment-friendly sampling and analysis can be achieved. It also shows a potential for speciation studies. With these potential advantages in mind, laboratory-made microcolumns were prepared from Teflon tubings (1.5 mm id) and were dry-packed with Duolite GT-73 chelating resin. Small pieces of sponge were placed at both ends of the columns and the packing is retained by inserting additional tubes. Later, the microcolumns were rinsed with ultra-pure water until any excess reagent was eliminated from the resin.

3.1.2.1.3.1. Effect of Microcolumn Length

As mentioned in Chapter 2, the column dimensions and physical characteristics are critical in terms of analytical performance necessitating the optimization of column length. For this purpose, microcolumns of Duolite GT-73 resin ranging from 1-10 cm length were prepared and 40.0 µg/L of Sb(III) solutions were passed through the microcolumns. The effluents were analyzed by SFI-HGAAS using 0.12 M HCl as the carrier solution and 2% (m/v) NaBH₄ as the reductant. The sampling flowrate was kept at 1.0 mL/min and it was found that the minimum length of the column must be 5 cm for quantitative sorption. Therefore, in the rest of the studies, 5 cm microcolumns were applied.

3.1.2.1.3.2. Effect of Sorbent Particle Size

It was expected, in the beginning, that the use of smaller particle size would give improved retention. In order to check this, microcolumns were packed with the different particle sizes of from 75 to 300 μm were prepared and subjected to sorption procedure. The microcolumns packed with 125-150 μm Duolite GT-73 resin was found to give the maximum sorption. It was not possible to use smaller particle sizes due to high back-pressure generated.

3.1.2.1.3.3. Effect of flowrate during deposition and elution in microcolumns

It is known that the sampling/elution flowrates must be adjusted very carefully for a better quality analysis. To determine the optimum flowrate for sorption Sb(III) solutions were passed at various flowrates from 0.5-5 mL/min through the microcolumns of Duolite GT-73 resin. Maximum adsorption of Sb(III) on the resin was obtained at a flowrate of 1 mL/min. Sorption was not quantitative at higher flowrates due to incomplete adsorption. Elution flowrate was kept at 1 mL/min in all experiments.

3.1.2.1.4. Extraction Efficiency as a Function of pH

Extraction efficiency of many of the sorbents used in speciation studies is pH dependent. In order to examine the sorption behavior of Duolite GT-73 resin towards Sb(III) and Sb(V) separate standard solutions of 40.0 $\mu\text{g/L}$ Sb(III) and Sb(V) were prepared in various concentrations of HCl from 4 M to 1 M and pH range between 1-10 at constant ionic strength. About 0.1 g of the resin was added into each solution after the usual sorption and filtration steps, the filtrates were analyzed as before for their Sb concentrations. The sorption efficiency at different pH and acidities are shown in Figure 3.9.

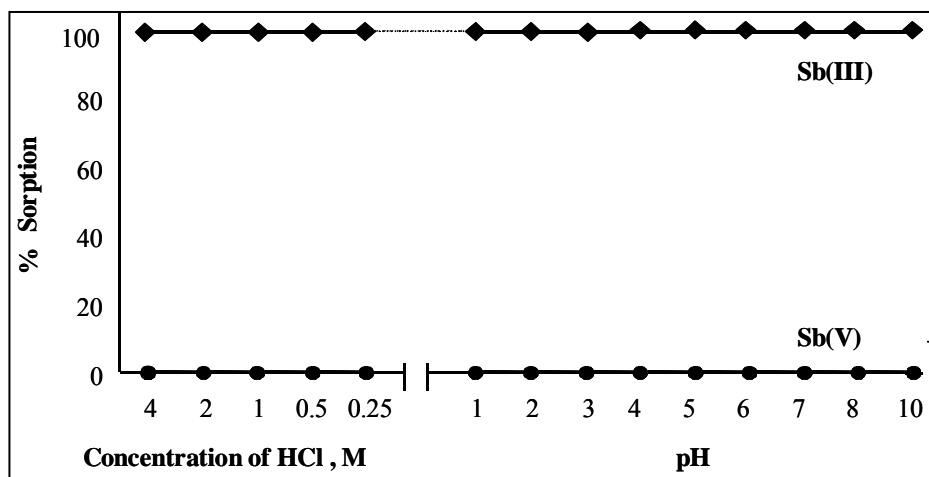

Figure 3.9. Percentage uptake of Duolite GT-73 chelating resin for Sb(III) and Sb(V) as a function of pH and acidity.(◆) Sb(III) and (●) Sb(V).

As seen from the figure, the uptake of neither species is pH or acidity dependent in the range of 4 M HCl to pH 10. Sb(III) is taken up by Duolite GT-73 resin at all pH and acidity values whereas Sb(V) is not taken up at any pH and acidity values. Moreover, there would not be any need to adjust the pH of the working solutions when working with real water samples. This property may be considered as an important advantage since it will possibly eliminate the pH-adjustment step when working with real samples.

3.1.2.1.5. Performance of Speciation and Preconcentration Steps

3.1.2.1.5.1. Preconcentration Ratio

In order to investigate the preconcentration efficiency of Duolite GT-73 chelating resin with the proposed method, the sorption studies were performed using variable volumes from 20-2000mL of the real water samples including ultra-pure water, tap water, sea water and bottled drinking water. The final volume of the eluent solution (0.05 M KIO_3 in 2 M HCl) was 20 mL. The results are depicted in Tables 3.4, 3.5, 3.6 and 3.7.

Table 3.4. Recovery results for ultra-pure water.

	Sb(III) spike ($\mu\text{g/L}$)	Initial Volume	Final Volume	Enrichment Factor	Sb(III) found	Recovery %
Ultra pure Water	20	20	20	1	23.0 (\pm 1.0)	114.9 (\pm 5.1)
	4	100	20	5	21.9 (\pm 0.9)	109.7 (\pm 4.3)
	1	400	20	20	16.5 (\pm 0.5)	82.7 (\pm 2.3)
	0.2	2000	20	100	7.3 (\pm 0.5)	36.5 (\pm 2.5)

Table 3.5. Recovery results for bottled-drinking water.

	Sb(III) spike ($\mu\text{g/L}$)	Initial Volume	Final Volume	Enrichment Factor	Sb(III) found	Recovery %
Bottled Drinking Water	20	20	20	1	22.4 (\pm 1.8)	112.1 (\pm 9.1)
	4	100	20	5	19.7 (\pm 1.0)	98.3 (\pm 5.2)
	1	400	20	20	14.6 (\pm 0.5)	73.1 (\pm 2.6)
	0.2	2000	20	100	5.8 (\pm 0.6)	28.9 (\pm 3.0)

Table 3.6. Recovery results for sea-water.

	Sb(III) spike ($\mu\text{g/L}$)	Initial Volume	Final Volume	Enrichment Factor	Sb(III) found	Recovery %
Sea Water	20	20	20	1	19.6 (\pm 0.2)	98.1 (\pm 1.0)
	4	100	20	5	4.4 (\pm 1.8)	21.9 (\pm 9.2)
	1	400	20	20	2.6 (\pm 0.8)	12.9 (\pm 3.9)
	0.2	2000	20	100	2.5 (\pm 0.6)	12.3 (\pm 3.1)

Table 3.7. Recovery results for tap water.

	Sb(III) spike ($\mu\text{g/L}$)	Initial Volume	Final Volume	Enrichment Factor	Sb(III) found	Recovery %
Tap Water	20	20	20	1	3.9 (\pm 0.2)	19.6 (\pm 1.2)
	4	100	20	5	-	-
	1	400	20	20	-	-
	0.2	2000	20	100	-	-

As can be seen from Tables 3.4, 3.5, and 3.6, the proposed methodology works efficiently when a separation is desired. In fact, this matrix-removal step might be sufficient for some situations where there is no need for preconcentration. A very interesting and difficult-to-explain situation was obtained in the studies with tap water in our campus. The percent recovery was about 20 % even no preconcentration was applied. The tap water in Urla is very hard and it might have caused the recovery to be very low.

Another very important point must be mentioned here; in these spike recovery studies a L-cysteine was not used due to economical reasons; and this might have caused Sb(III) not to be stabilized in the matrix and to be converted to a species that is not retained by Duolite GT-73 resin. The situation was even worse for higher volumes (lower concentration-spikes) of tap water.

When the spike levels were decreased to 4.0 µg/L (by increasing the sample volume but keeping the absolute amount constant), the method still works efficiently for ultrapure and bottled-drinking waters, but not for sea water. This results indicates that the method can still be applied for separation purposes for the determination of antimony in samples with heavy matrix.

The recovery results obtained from 400 mL samples with 1 µg/L Sb(III) concentrations, can be acceptable for screening tests. In these studies the amount of resin was between 0.1 to 1.0 g depending on the volume of the solutions. An improvement in the recovery results is expected with an increase on the amount of resin used which has not been tried yet. The use of L-cysteine may also provide greater recoveries.

3.1.3. Method Validation

3.1.3.1 Recoveries with Sb(III) and Sb(V)

The efficiency of the proposed method, for Sb(III) and Sb(V) with and without pre-reduction step was checked with microcolumns of Duolite GT-73 resin. The results given in Table 3.8 are efficient for Sb(III) with/without L-cysteine pre-reduction and for Sb(V) with L-cysteine pre-reduction.

Table 3.8. Spike recovery results for Sb(III) and Sb(V) with ultrapure water. (2% L-cysteine was used as the pre-reductant)

Sb(III)	Sb(V)	Sample Pretreatment	Sb Found ($\mu\text{g/L}$)	% Recovery
20	-	No	19.8 (± 0.7)	99.0 (± 3.5)
20	-	Yes	20.1 (± 0.9)	100.5 (± 5.0)
-	20	No	-	-
-	20	Yes	20.4 (± 0.2)	102.0 (± 1.0)
20	20	No	20.8 (± 0.1)	104.0 (± 0.5)
20	20	Yes	40.7 (± 0.8)	101.8 (± 2.0)

3.1.3.2. Performance of the Study

The accuracy of the method was tested by analyzing the antimony concentration of a standard reference material. The composition of the SRM used is given in Table 3.9.

Table 3.9. Composition of the SRM “Trace Elements in Natural Water” (NIST, Cat. No. 1640) used in the study.

Certified Mass Fractions			
Element	($\mu\text{g}/\text{kg}$)	Element	($\mu\text{g}/\text{kg}$)
Aluminum	52.0 ± 1.5	Iron	34.3 ± 1.6
Antimony	13.79 ± 0.42	Lead	27.89 ± 0.14
Arsenic	26.67 ± 0.41	Manganese	121.5 ± 1.1
Barium	148.0 ± 2.2	Molybdenum	46.75 ± 0.26
Beryllium	34.94 ± 0.41	Selenium	21.96 ± 0.51
Boron	301.1 ± 6.1	Silver	7.62 ± 0.25
Cadmium	22.79 ± 0.96	Strontium	124.2 ± 0.7
Chromium	38.6 ± 1.6	Vanadium	12.99 ± 0.37
Cobalt	20.28 ± 0.31		
Reference Mass Fractions			
Element	($\mu\text{g}/\text{kg}$)	Element	(mg/kg)
Copper	85.2 ± 1.2	Calcium	7.045 ± 0.089
Lithium	50.7 ± 1.4	Magnesium	5.819 ± 0.056
Nickel	27.4 ± 0.8	Silicon	4.73 ± 0.12
Potassium	994 ± 27	Sodium	29.35 ± 0.31
Rubidium	2.00 ± 0.02		
Zinc	53.2 ± 1.1		
Information Mass Fraction			
Thallium	$< 0.1 \text{ mg}/\text{kg}$		

SRM solution was analyzed as explained in Section 2.3.3.2. in triplicate by the proposed methodology utilizing microcolumns of Duolite GT-73 resin. The concentration of Sb was found to be $13.3 \pm (1.1) \mu\text{g}/\text{L}$ with a percent recovery of $96.4 (\pm 8.0)$. In addition to the microcolumn proposed methodology the SRM solution was analyzed also with

SFI-HGAAS system directly after acidification and Sb concentration very close to the certified value found.

Table 3.10. Results obtained for SRM solution.

	Certified Value ($\mu\text{g/L}$)	Found ($\mu\text{g/L}$)	% Recovery
Direct Determination by HGAAS	13.79 (± 0.42)	13.1	95.0
Proposed Methodology	13.79 (± 0.42)	13.3 (± 1.1)	96.4 (± 8.0)

These results may be evaluated in such a way that there is no need to apply the Duolite GT-73 microcolumn method for such situations. However, it is essential to mention here that the SRM used does not contain a high matrix and can be considered as a “clean” solution for HGAAS to be directly applied. But in case of analyzing a solution with a heavy matrix, there is always need to employ a matrix separation and/or preconcentration step prior to determination.

The efficiency of the proposed separation/preconcentration scheme was performed through another spike recovery experiment. So, to examine the accuracy of HGAAS measurements, electrothermal AAS was used by analyzing the same samples prepared. The solutions prepared in the usual way as before were analyzed by SFI-HGAAS and also by ETAAS for comparison. The results are given in Table 3.11. Almost identical results were obtained as shown in Table 3.11.

Table 3.11. Recovery results obtained for synthetic SRM solution.

	Sb(III) spike ($\mu\text{g/L}$)	Initial Volume	Final Volume	Enrichment Factor	Sb(III) determined by HGAAS ($\mu\text{g/L}$)	Recovery %	Sb(III) determined by ETAAS ($\mu\text{g/L}$)	Recovery %
	50	20	20	1	53.5	107	51.5	101
	20	50	20	2.5	50.5	101	42.5	85
Synthetic	10	100	20	5	45.2	90	35.8	72
SRM	5	200	20	10	36.9	74	26.5	53
Solution	2	500	20	25	28.9	58	23.6	47
	0.5	2000	20	100	18.7	38	17.5	35

3.1.3.3. Analysis of Real Water Samples

The proposed method involving the use of microcolumns was applied to several bottled drinking water samples for antimony determination. The samples were found to contain no Sb above the permissible level. The concentrations were below limit of quantitation which can be assumed as 10 times the standard deviation above the blank value.

A spike recovery test was also applied to check the efficiency of the method for these samples and was found to be working well.

Table 3.12. Results obtained from bottled drinking water samples using the proposed methodology.

Sample	Sb Concentration ($\mu\text{g/L}$)
BDW 1	< LOQ
BDW 2	< LOQ
BDW 3	< LOQ
BDW 4	< LOQ
BDW 5	< LOQ
BDW 6	< LOQ
BDW 7	< LOQ
BDW 8	< LOQ
BDW 9	< LOQ
BDW 10	< LOQ
BDW 1 + 15 $\mu\text{g/L}$ Sb(III)	12.6 (\pm 0.5)
BDW 1 + 30 $\mu\text{g/L}$ Sb(III)	25.5 (\pm 0.8)

(LOQ= 3 $\mu\text{g/L}$)

3.2. Determination of Manganese

3.2.1 Calibration plots for Mn(II) and Mn(VII) with FAAS

In order to obtain the calibration plot for Mn, standards were prepared in concentrations from 0.01 to 2.5 mg/L. For lower concentrations, Figure 3.10 was used in which a good linearity is obtained even in 0.01 to 0.1 mg/L range. In addition, Mn(II) and Mn(VII) standards were prepared separately to check whether they give different responses (Figure 3.10). As can be seen from the figure the calibration plot is independent of the chemical form which the standards are prepared from (MnSO_4 or KMnO_4). For the aqueous standards, the *characteristic concentration* (the concentration of the analyte corresponding to an absorbance of 0.0044) is 0.0396 mg/L and the limit of detection (LOD) based on 3s (3 times the standard deviation above the blank value is) 0.054 mg/L.

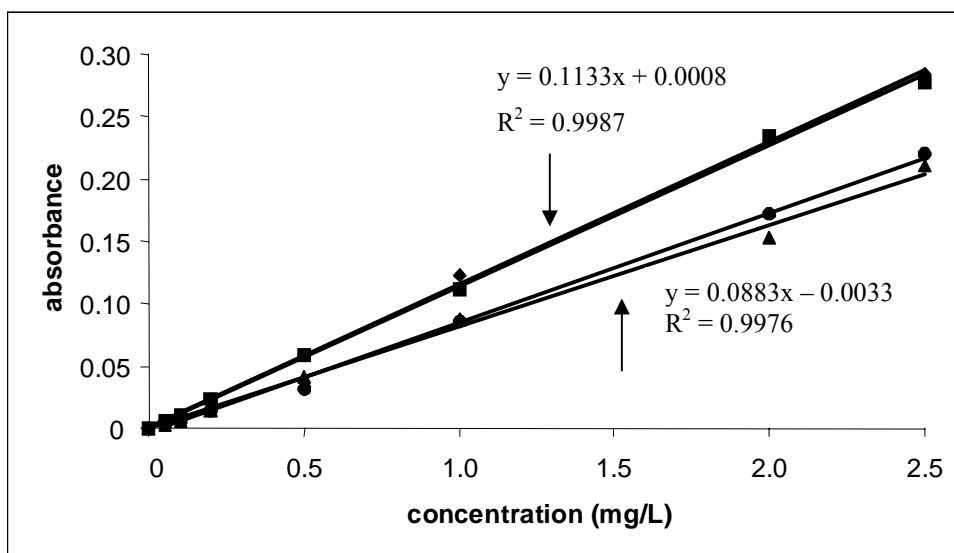

Figure 3.10. Calibration curves of aqueous (\blacksquare) Mn(II) and (\blacklozenge) Mn(VII) and matrix-matched standards, (\blacktriangle) Mn(II), (\bullet) Mn(VII).

In addition to aqueous calibration plots, the so-called “recovered calibration plot” was also obtained using the proposed sorption-elution steps with Amberlite XAD-7HP resin (As will be shown later, this resin was used in sorption studies with Mn). The purpose of this experiment was to prepare matrix-matched standards. As also shown in Figure 3.10, the matrix-matched standards give a calibration plot with a 30% reduction in sensitivity.

3.2.2. Studies for Sorption and Speciation of Mn(II) and Mn(VII)

3.2.2.1. Sorption

As mentioned in Introduction, the form of Mn is very sensitive to redox conditions and pH of the natural matrices. Depending also on the presence of other ions in the solutions Mn can be found in different forms. In a study by Quddane et al. [57], about 60 % in marine water and about 90% in river water of the total Mn have been reported to be in Mn^{2+} form in the Seine river estuary. The results are consistent with the manganese Eh-pH diagram (Figure 1.5).

In this study, our purpose was to find a proper method for the determination of Mn^{2+} in natural waters. In addition to Mn^{2+} , similar investigations were carried out for Mn(VII) to obtain supplementary information. For this purpose, several ion-exchange or chelating resins, natural and synthetic zeolites were tried as sorbents and their selectivity towards Mn(II) and Mn(VII) were examined. Standard solutions of (2.0 mg/L, 20 mL) Mn(II) and Mn(VII) were prepared separately from their respective stock solutions. As an initial study, the pH of the solutions was adjusted to 7.0 and percent sorption was determined using batch process. About 0.100 g sorbent was added and the solution was shaken manually for 1-2 minutes and then placed on the shaker for another 15 minutes. The contents were filtered through filter paper and the filtrate was used for the determination of percent sorption.

Table 3.13. Sorption of Mn(II) and Mn(VII) towards selected sorbents.

Sorbents	% Sorption	
	Mn(II)	Mn(VII)
Alumina basic	~ 80	~ 40
Chelex 100	> 95	~ 40
Duolite GT-73	> 95	> 95
Clinoptilolite	> 95	> 90
Zeolite beta	> 95	> 95
Zeolite Y	> 95	> 95
Zeolite ZSM-5	> 95	> 95
MCM-41	> 95	> 90
Chitin	~ 85	> 95
chitosan ^a	> 95	> 90
chitosan ^b	~ 50	> 95
chitosan ^c	~ 65	> 95
Amberlite IRN-78	> 95	> 95
Amberlite IRA-743	~ 80	~ 80
Amberlite IR 120	> 95	~ 30
Dowex 1X4	> 95	~ 30
Dowex 50 WX4	> 95	> 95
Duolite C-467	> 95	~ 30
Diaion SK 116	> 95	~ 40
Diaion SK 1BS	> 95	~ 35
Diaion SA 20A	> 95	~ 35
Rexyn 101	> 95	~ 35
Amberlite XAD-7HP	~ 15	~ 80

^a low molecular weight, ^b medium molecular weight, ^c high molecular weight

Table 3.13 gives preliminary results about the uptake of selected sorbents towards Mn(II) and Mn(VII) species. In view of the fact that sufficient information could not be obtained from Table 3.14, it was decided to determine the percent sorption of the various sorbents at acidic, neutral and basic media. For this purpose, the pH of the solutions was adjusted to 3.0, 7.0 and 10.0 and percent sorption was determined using the same procedure mentioned above. The percentage sorption graphs for the selected sorbents at different pH values are shown in Figures 3.11-3.14.

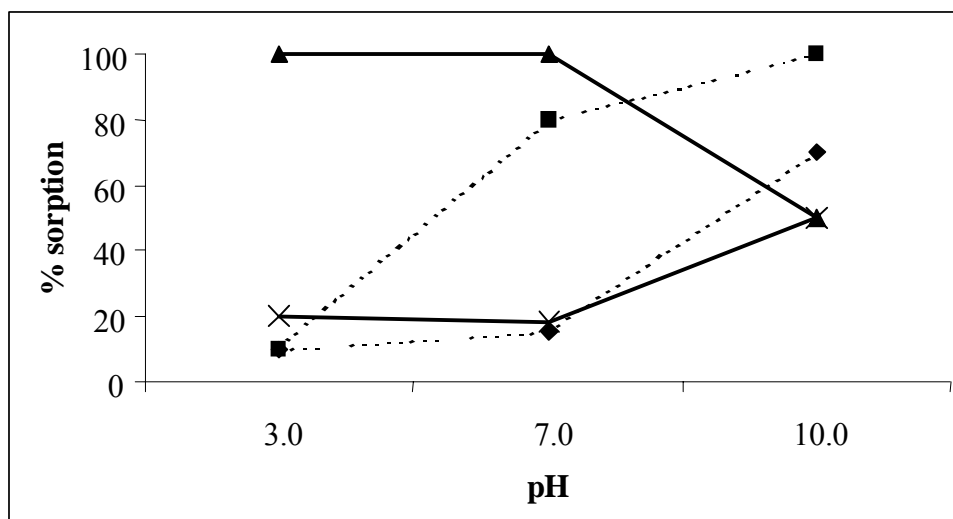

Figure 3.11. Percentage uptake of Amberlite XAD-7HP, (●) Mn(II), (■) Mn(VII) and Duolite C-467 (▲) Mn(II), (◆)Mn(VII) as a function of pH.

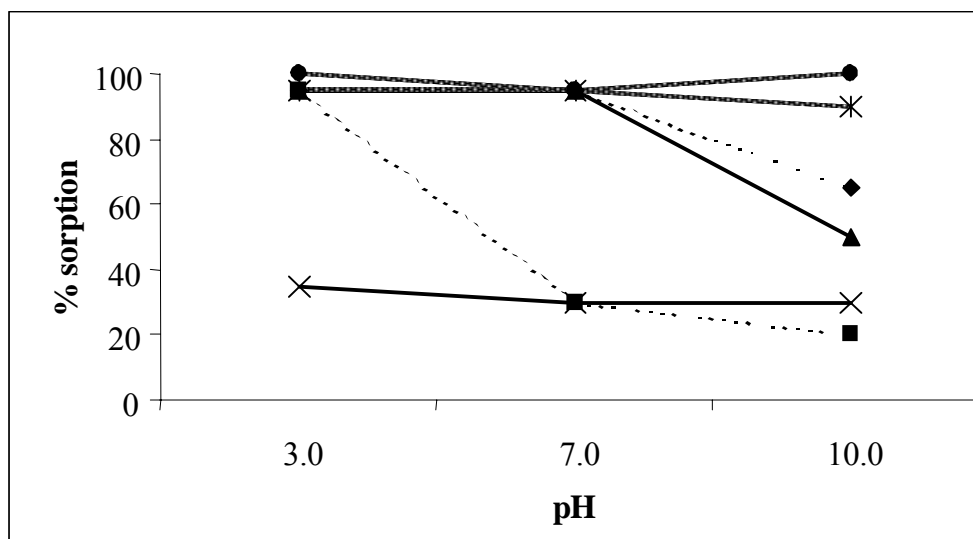

Figure 3.12. Percentage uptake of Diaion SK 1BS (◆) Mn(II), (■) Mn(VII), Diaion SK 116 (▲) Mn(II), (x) Mn(VII) and Dowex 50WX4 (*) Mn(II), (●)Mn(VII) Mn(II) as a function of pH.

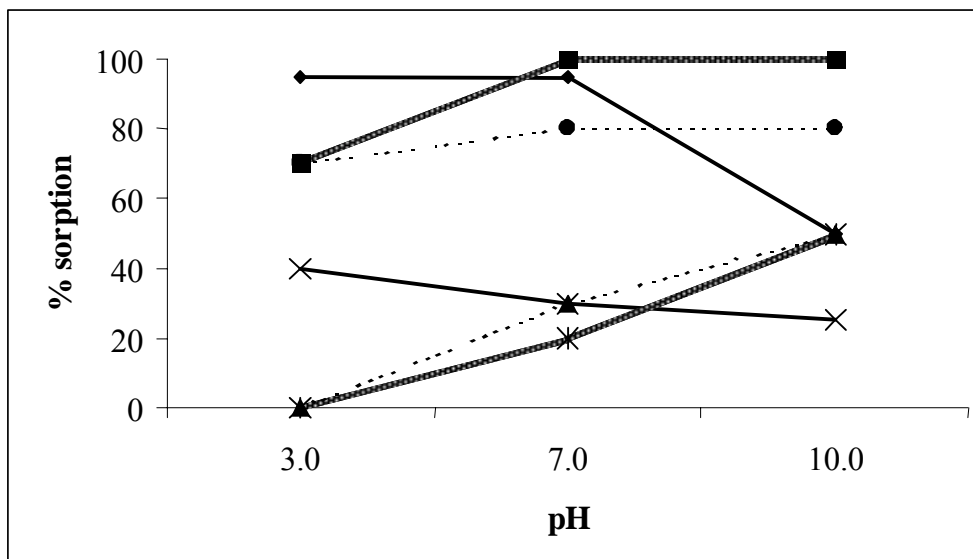

Figure 3.13. Percentage uptake of Amberlite 120 plus (◆) Mn(II), (x) Mn(VII), Diaion SA 20 A (*) Mn(II), (■) Mn(VII) and Dowex 1X4 (▲) Mn(II), (●) Mn(VII) as a function of pH.

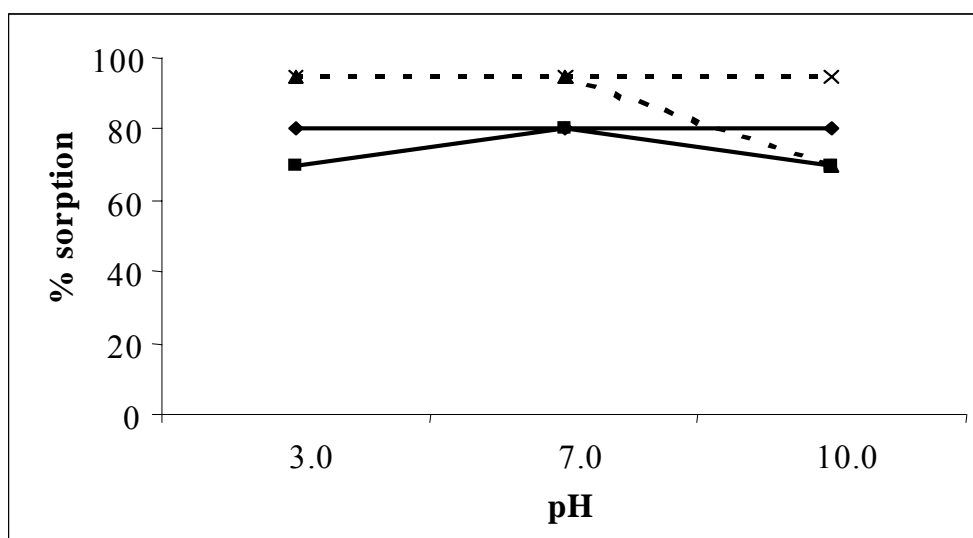

Figure 3.14. Percentage uptake of Amberlite IRA 743 (◆) Mn(II), (■) Mn(VII) and Amberlite IRN 78 (▲) Mn(II), (x)Mn(VII) as a function of pH.

Among the sorbents tried, Amberlite XAD-7HP gave the most promising results for the speciation of Mn. Therefore, the further experiments were carried out with Amberlite XAD-7HP resin. It is a macroporous acrylic ester resin with no functional group on it [67]. It resembles other XAD resins like XAD-1, -2, and -4 which comprise styrene polymers with divinylbenzene crosslinking. These XAD resins can be applied directly or after a chemical pretreatment step to introduce ionic groups. For example, Doğutan et al. [58] functionalized XAD-2 with palmitoyl quinolin-8-ol and used the modified resin to preconcentrate Mn(II) from natural waters. In our study, we did not apply a treatment step and used Amberlite XAD-7HP in its original form.

3.2.2.2. Extraction Efficiency as a Function of pH

The studies in which Amberlite XAD-7HP was used have shown that the preconcentration ability of the resin is pH-dependent. Many workers mention about the differences in the extraction efficiency of XAD-7 type resins depending on the charge of the metal ion; whether it is divalent, trivalent etc. [Reference No.67 and the related references therein]. For this reason, the first experiment with the resin was about the determination of its extraction efficiency for Mn(II) and Mn(VII) at different pH values by batch equilibration.

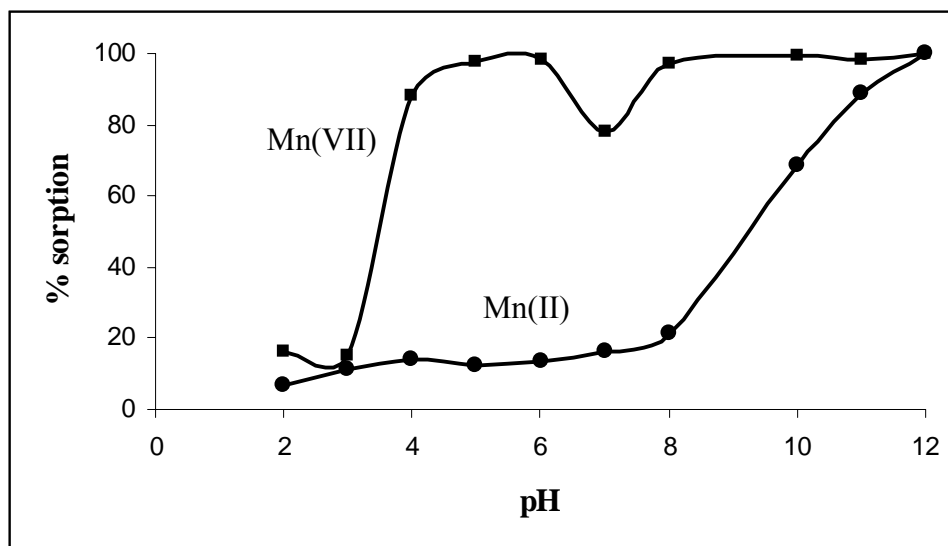

Figure 3.15. Percentage uptake of Amberlite XAD-7HP resin for Mn(II) and Mn(VII) as a function of pH. (●) Mn(II) and (■) Mn(VII).

As it is illustrated in Figure 3.15 Mn(VII) is taken up by the resin almost quantitatively between pH 4 and 12 except pH 7 where the sorption is about 80 %. It is also seen from the figure that Mn(II) adsorption is less than 20 % from pH 2 to 8. Then its retention reached its maximum value at a pH of 12. Without going further, based on this observation and the Eh- pH diagram of Mn (Figure 1.5) it can be said that Mn(II) at this pH was not Mn^{2+} ion anymore and had been converted to MnO_2 (or any other insoluble manganese species namely $Mn(OH)_2$, Mn_3O_4 , $MnCOOH$). So, it was the physical retention of solid MnO_2 on the resin particles, or more possibly on the filter paper during filtration rather than the ionic bonding of Mn^{2+} in the macro pores of Amberlite XAD-7HP resin. When the initial concentration of Mn^{2+} in the solution was 2.0 mg/L or lower MnO_2 particles formed could not easily be seen by the naked eye. When the concentration exceeded 2.0 mg/L, brownish-black MnO_2 was readily seen on the filter paper. (This experiment was repeated without adding Amberlite XAD-7HP and pH of solution was brought to 12 with the addition of 1 M NaOH. Meanwhile, a precipitate was obtained and filtered out.) Both the filtrate and the precipitate after dissolution in HCl were analyzed for their Mn content and it was found that more than 90 % of the original Mn was in the solid phase and the rest in the filtrate. This finding confirmed the precipitation of MnO_2 (or other insoluble forms) under these conditions.

In the next set of experiments, it was planned to repeat sorption studies at different pH values for Mn(II) alone, Mn(VII) alone and Mn(II) + Mn(VII) together. For this purpose three pH values were selected to work at; namely pH 1, 5, and 12. The results are given in Table 3.14.

Table 3.14. Percent sorption of Mn species by Amberlite XAD-7HP at different pH values (sample volume = 20 mL, amount of resin= 0.100 g, initial concentrations= 2.0 mg/L for both Mn(II) and Mn(VII), n =3)

	% sorption		
	pH = 1	pH =5	pH =12
Mn(II) alone	31 (\pm 5)	19 (\pm 2)	95 (\pm 3)
Mn(VII) alone	23 (\pm 2)	98 (\pm 1)	95 (\pm 2)
Mn(II) + Mn(VII) together	83 (\pm 3)	97 (\pm 1)	93 (\pm 3)

As can be understood from Table 3.14, the percent sorption results for Mn(II) and Mn(VII) when they are alone are in accordance with the previous findings. But when they were together in the same solution, they demonstrate very high take-up even at pH=1 (> 80 % take-up). Although this result was thought to be wrong at first look, it is likely to be true due to the following reaction [17].

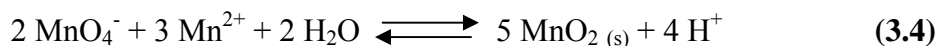

It is mentioned that this reaction has an equilibrium constant of about 10^{47} ; but the rate at which it occurs is said to be slow. In our experiments during sorption, the solutions were being shaken at least 15 minutes and this relatively long time must have been sufficient for the formation of MnO_2 precipitate in the solution. And again, since the mixture is filtered after shaking with the resin (so MnO_2 is removed), the filtrate is found to contain less Mn than the expected amount. This finding can lead to further studies in which MnO_2 precipitation can be used to determine the concentration of Mn(II) in the original solution and/or it can be used for the coprecipitation of some trace elements in various samples [67].

3.2.2.3. Desorption Studies

As explained in Experimental two strategies were followed for desorption of Mn from Amberlite XAD-7HP resin. The first strategy was to wash the surface of the resin with strong acids and to release the Mn species adsorbed by converting them into Mn^{2+} which is not adsorbed at low pH values. The second strategy was to apply several reactants such as KI (3.5), $\text{K}_2\text{C}_2\text{O}_4$ (3.6) based on the reactions;

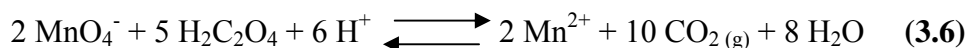
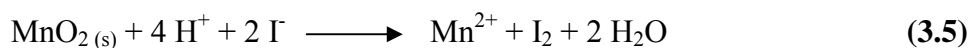

The results of the desorption (elution) studies are given in Table 3.15.

Table 3.15. Desorption of Mn species from Amberlite XAD-7HP.

Eluent	% elution
2 M HNO ₃	~ 45
2 M HCl	~ 45
0.02 M KI in 1 M HNO ₃	-
0.01 M K ₂ C ₂ O ₄ in 1 M HNO ₃	> 95

As seen from the table the most efficient eluent was 0.01 M K₂C₂O₄ (in 1 M HNO₃). It was so successful that it was able to desorb Mn(VII) species adsorbed on the resin and also dissolve MnO₂ readily. This is a new finding that, to our knowledge, nobody has used this eluent before.

3.2.2.4. Total Recovery of the Proposed Method for Mn Determination

Based on the sorption-elution studies, the expected total recovery of the method must have been greater than 90 %. In order to check whether this is achieved, separate solution of Mn(II) alone, Mn(VII) alone, and Mn(II) + Mn(VII) together, were prepared and subjected to the sorption-elution steps as before. The results are given in Table 3.16.

Table 3.16. Percent recovery of the proposed methodology (initial and final volumes, 15 mL; initial concentrations, 2.0 mg/L; eluent, 0.01 M K₂C₂O₄ in 1 M HNO₃; n = 2)

	% Recovery		
	pH = 2	pH = 5	pH = 12
Mn(II) alone	6 (± 1)	10 (± 1)	96 (± 2)
Mn(VII) alone	8 (± 1)	97 (± 1)	97 (± 7)
Mn(II) + Mn(VII) together	58 (± 4)	81 (± 4)	96 (± 6)

The results indicate the efficiency of the method. When the solution contains only one of the species, namely either Mn(II) or Mn(VII), the resin behaves selectively

depending on the pH of the solution. If pH is 2, neither Mn(II) nor Mn(VII) is adsorbed efficiently. The lower recoveries at acidic pH values must be due to the conversion of Mn species to Mn^{2+} which is not adsorbed by the resin. At pH 2, if the species had behaved as they were alone, we would have obtained about 10-20 % recovery. Instead, 58 % was obtained. This must be again due to the reaction 3.4 at the end of which MnO_2 could have been formed, collected on the filter paper and analyzed after dissolution in $\text{K}_2\text{C}_2\text{O}_4$ (in 1 M HNO_3). A similar effect is also observed at pH 5 together with the quantitative sorption of Mn(VII) on the resin. At pH 12; both species can be adsorbed (or collected) quantitatively.

When analyzing real samples pH must be adjusted to 12 if both species are to be determined. The precipitate formed can be analyzed for Mn concentration.

CHAPTER 4

CONCLUSION

Two independent topics have been studied in this thesis. In the first study, a new method utilizing a microcolumn of Duolite GT-73 resin (a chelating resin with –SH functional groups) is proposed for the speciation and preconcentration of Sb from waters. In the second, a similar method incorporating a microcolumn of Amberlite XAD-7HP (a macroporous resin with no functional groups) is suggested for the speciation of Mn from waters. Hydride generation and flame atomic absorption spectrometry were used in the determination of Sb and Mn, respectively.

It has been shown that Duolite GT-73 resin with its –SH functional groups can be employed for the selective sorption of Sb(III) from the waters. Since the predominant form of Sb in many types of oxic waters is Sb(V), a pre-reduction step with L-cysteine is required. The method works efficiently for $\mu\text{g/L}$ concentrations of Sb in which only a matrix removal step is necessary. If higher enrichments factors are needed, it can be realized by decreasing the final volume of eluent solutions rather than increasing the sample volume. This can be achieved by connecting the microcolumn loaded with Sb(III) directly to the HGAAS system (or to the nebulizer of an ICP-MS) and eluting the microcolumn on-line with a lower volume of eluent. Our system was a continuous flow hydride generation system requiring about 10-15 mL solution for one determination. So, if the microcolumn is incorporated into a FIA manifold, the method can be used for on-line separation and preconcentration which requires 1 mL of eluent at most. Another advantage of Duolite GT 73 resin is that there is no need for pH adjustment since only Sb(III) is retained on the column at all pH and acidity values.

In the speciation studies with Mn, Amberlite XAD-7HP resin has been shown to retain Mn(VII) between pH 4 and 12. Mn (II) determination in mg/L level can be done by forming MnO_2 precipitate at a pH of 12. The elution from the microcolumn and/or the dissolution of MnO_2 formed can be realized by $\text{K}_2\text{C}_2\text{O}_4$ in HNO_3 which have been shown to be very effective.

Both microcolumn systems for Sb and Mn species can be very advantageous in terms of suitability for the field work. The species can be processed *in situ* and brought to the laboratory more easily when compared to the conventional separation/preconcentration schemes involving large volumes of water samples. In addition, it is likely to preserve the species in their original forms utilizing microcolumns of proper sorbents.

REFERENCES

- [1] Howard, A.G., Statham, P. J., Inorganic Trace Analysis Philosophy and Practice, John Wiley and Son, UK, 1997.
- [2] Truitt, R.E., Weber, J.H., "Trace metal ion filtration at pH 5 and 7," *Anal. Chem.*, **51**, (1979), 2057.
- [3] Hoenig, M., "Preparation steps in environmental trace element analysis- facts and traps," *Talanta*, **54**, (2001), 1021.
- [4] Welz, B., Sperling, M., Atomic Absorption Spectrometry, WILEY-VCH, Weinheim, 1999.
- [5] Zih-Perenyi, K., Laszteity, A. Kelko-Levai, A., "On-line preconcentration and GFAAS determination of trace metals in waters," *Microchem. Journal*, **67**, (2000), 181.
- [6] De la Calle Guntinas, M.B., Madrid, Y., Camara, C., "Determination of total available antimony in marine sediments by slurry-formation-hydride generation atomic absorption spectrometry, applicability to the selective determination of Antimony(III) and Antimony(V)," *Analyst*, **1116**, (1991), 1029
- [7] Mandal, B.K., Ogra, Y., Suzuki, K.T., "Speciation of arsenic in human nail and hair from arsenic-affected area by HPLC-inductively coupled argon plasma mass spectrometry," *Toxicology and Applied Pharmacology*, **189**, (2003), 73.
- [8] Howard, A.G., Volkan, M., Ataman, O.Y., "Selective pre-concentration of arsenite on mercapto-modified silica gel," *Analyst*, **112**, (1987), 159.
- [9] Yebra, M.C., Garcia, A., Moreno-Cid, A., Puig, L., "Design of a field flow preconcentration system for cadmium determination in seawater by flow injection atomic absorption spectrometry," *Talanta*, **56**, (2001), 777.
- [10] Sperling, M., Xu, S., Welz, B., "Determination of Cr(III) and Cr(VI) in water using flow injection on-line preconcentration with selective adsorption on activated alumina and flame atomic absorption spectrometry," *Anal. Chem.*, **64**, (1992), 3101.
- [11] Dadfarnia, S., McLeod, C.W., "On-line trace enrichment and determination of uranium in waters by floe injection inductively coupled plasma mass spectrometry," *Appl. Spectro.*, **48**, (1994), 1331.

- [12] Eroğlu, A.E., McLeod, C.W, Leonard, K.S., McCubbin, D., “Determination of technetium in sea-water using ion-exchange and inductively coupled plasma mass spectrometry with ultrasonic nebulization,” *J. Anal. At. Spectrom.*, **13**, (1998), 875.
- [13] Fang, Z., Flow Injection Separation and Preconcentration, VCH Publishers, Weinheim, 1993.
- [14] Welz, B., “Speciation analysis: The future of atomic absorption spectrometry,” *J. Anal. At. Spectrom.*, **13**, (1998), 413.
- [15] Campanella, L., Pyrzynska, K., Trojanowicz, M., “Chemical speciation by flow-injection analysis,” *Talanta*, **43**, (1996), 825.
- [16] Godden, R.G., Thomerson, D.R., “Generation of covalent hydrides in atomic absorption spectrometry,” *Analyst*, **105**, (1980), 1257.
- [17] Skoog, D.A., Holler, F.J., Nieman, T.A., Principles of Instrumental Analysis, 5th edition, Saunders College Publishing, Philadelphia, 1998.
- [18] Ruzicka, J., Hansen, E. H., Flow Injection Analysis, 2nd edition, John Wiley and Sons, New York, 1988.
- [19] Valcarcel, M., Luque de Castro, M.D., Flow Injection Analysis – Principles and Applications, John Wiley and Sons, Chichester, 1987.
- [20] Fiella, M., Belzile, N., Chen, Y.W., “Antimony in the environment: a review focused on natural waters: I. Occurrence,” *Earth-Sci. Rev.*, **57**, (2002), 125.
- [21] United States Environmental Protection Agency, “Water Related Fate of the 129 Priority Pollutants,” USEPA, 1, (1979), EP-440/ 4-79-029A.
- [22] Council of the European Communities, “Council Directive 76/464/EEC of 4 May 1976 on pollution caused by certain dangerous substances discharged into the aquatic environment of the Community,” *Official Journal L*, 129, (1976), 23.
- [23] United States Environmental Protection Agency, “National Primary Drinking Water Standards,” USEPA Office of Water, (1999), Doc. 810-F-94-001.
- [24] Council of the European Union, “Council Directive 98/83/EC of 3 November 1998 on the quality of water intended for human consumption,” *Official Journal L*, 330, (1998), 32.
- [25] Bencze, K., Handbook on Metals in Clinical and Analytical Chemistry, Marcel Dekker, New York, 1994.

- [26] Ariza, J.L.G., Morales, E., Sanchez-Rodas, D., Giraldez, I., "Stability of chemical species in environmental matrices," *Trends Anal. Chem.*, **19**, (2000), 200.
- [27] Fiella, M., Belzile, N., Chen, Y.W., "Antimony in the environment: a review focused on natural waters: II. Relevant solution chemistry," *Earth-Sci. Rev.*, **59**, (2002), 265.
- [28] Wang, E., Sun, W., Yang, Y., "Potentiometric stripping analysis with a thin-film gold electrode for determination of copper, bismuth, antimony and lead," *Anal. Chem.*, **56**, (1984), 1903.
- [29] Ariza, J.L.G., Sayago, A., Beltran, R., "Hydride generation atomic fluorescence spectrometry (HG-AFS) as a sensitive detector for Sb(III) and Sb(V) speciation in water," *J. Anal. At. Spectrom.*, **15**, (2000), 423.
- [30] Dingman, J., Siggia, S., Barton, C., Hiscock, B., "Concentration and separation of trace metal cations by complexation on polyamine-polyurea resins," *Anal. Chem.*, **44**, (1972), 1351.
- [31] Dingman, J., Siggia, S., Gloss, K.M., Milano, E.A., "Concentration of heavy metals by complexation on dithiocarbamate resins," *Anal. Chem.*, **46**, (1974), 774.
- [32] Andreae, M.O., Asmode, J.F., Foster, P., Dack, L.V., "Determination of antimony(III), antimony(V) and methylantimony species in natural waters by atomic absorption spectrometry with hydride generation," *Anal. Chem.*, **53**, (1981), 1766.
- [33] Sturgeon, R.E., Willie, S.N., Berman, S.S., "Preconcentration of selenium and antimony from sea-water for determination by graphite furnace atomic absorption spectrometry," *Anal. Chem.*, **57**, (1985), 6.
- [34] Kamada, T., Yamamoto, Y., "Selective determination of antimony(III) and antimony(V) with ammonium pyrrolidinedithiocarbamate, sodium diethyldithiocarbamate and dithizone by atomic-absorption spectrometry with a carbon-tube atomizer," *Talanta*, **24**, (1977), 330.

- [35] Han-Wen, S., Xiao-Quan, S., Zhe-Ming, N., "Selective separation and differential determination of antimony(III) and antimony(V) by solvent extraction with *N*-benzoyl-*N*-phenylhydroxylamine and graphite-furnace atomic-absorption spectrometry using a matrix-modification technique," *Talanta*, **29**, (1982), 589.
- [36] Sato, S., "Differential determination of antimony(III) and antimony(V) by solvent extraction-spectrophotometry with mandelic acid and Malachite Green, based on the difference in reaction rates," *Talanta*, **32**, (1985), 341.
- [37] Sugawara, K.F., Weetall, H.H., Shucker, D.G., "Preparation, properties and applications of 8-hydroxyquinoline immobilized chelate," *Anal. Chem.*, **46**, (1974), 489.
- [38] Leyden, D.E., Luttrell, G.H., "Preconcentration of trace metals using chelating groups immobilized via silylation," *Anal. Chem.*, **47**, (1975), 612.
- [39] Yu, M., Liu, G., "Determination of trace arsenic, antimony, selenium and tellurium in various oxidation states in water by hydride generation and atomic-absorption spectrophotometry after enrichment and separation with thiol cotton," *Talanta*, **30**, (1983), 265.
- [40] Gürleyük, H., Van Fleet-Stalder, V., Chasteen, T.G., "Confirmation of the biomethylation of antimony compounds," *Appl. Organomet. Chem.*, **11**, (1997), 471.
- [41] Skoog, D.A., West, D.M., Fundamentals of Analytical Chemistry, 7th edition, Holt-Saunders Inter. Ed's, USA, 1997.
- [42] Yonehara, N., Nishimoto, Y., Kamada, M., "Indirect spectrophotometric determination of traces of antimony(III) based on its oxidation by chromium(VI) and reaction of chromium(VI) with diphenylcarbazide," *Anal. Chim. Acta*, **172**, (1985), 183.
- [43] Haffer, E., Schmidt, D., Freimann, P., Gerwinski, W., "Simultaneous determination of germanium, arsenic, tin and antimony with total-reflection X-ray fluorescence spectrometry using the hydride generation technique for matrix separation-first steps in the development of a new application," *Spectrochim. Acta B*, **52**, (1997), 935.

- [44] Montesinos, P., Cervera, M.L., Pastor, A., Guardia, M., "Determination of arsenic and antimony in milk by hydride generation atomic fluorescence spectrometry," *Talanta*, **60**, (2003), 787.
- [45] Sun, Y.C., Yang, J. Y., "Simultaneous determination of arsenic(III,V), selenium(IV,VI), and antimony(III,V) in natural water by coprecipitation and neutron activation analysis," *Anal. Chim. Acta*, **395**, (1999), 293,
- [46] León, C.A., Montes-Bayón, M., Caruso, J.A., "Elemental speciation by chromatographic separation with inductively coupled plasma mass spectrometry detection," *J. Chromatogr.*, **974**, (2002), 1.
- [47] Kubota, T., Kawakami, A., Sagara, T., Ookubo, N., Okutani T., "Determination of antimony content in natural water by graphite furnace atomic absorption spectrometry after collection as antimony(III)-pyrogallol complex on activated carbon," *Talanta*, **53**, (2001), 1117.
- [48] De la Calle Guntinas, M.B., Camara, C., Madrid, Y., "Flow-injection and continuous-flow systems to determine Sb(III) and Sb(V) by hydride generation atomic absorption spectrometry," *Anal. Chim. Acta*, **232**, (1991), 161.
- [49] Garbos, S., Bulska, E., Hulanicki, A., Shcherbinina, N.I., Sedykh, E.M., "Preconcentration of inorganic species of antimony by sorption on Polyorgs 31 followed by atomic absorption spectrometry detection," *Anal. Chim. Acta*, **342**, (1997), 167.
- [50] Teo, K.C., Chen, J., "Determination of manganese in water samples by flame atomic absorption spectrometry after cloud point extraction," *Analyst*, **126**, (2001), 534.
- [51] Kargosha, K., Norrozifar, M., "Flow Injection Speciation Analysis of Manganese in Real Samples by Diphenylcarbazide-Spectrophotometric Determination," *Turk J. Chem.*, **27**, (2003), 227.
- [52] Qian, A.X.S., Huang Fei He, G., Han, X., "Separation and preconcentration of Mn(VII) / Mn(II) speciation on crosslinked chitosan and determination by flame atomic absorption spectrometry," *Analyst*, **126**, (2001), 239.
- [53] Yebra-Biurrun, M.C., Garcia-Dopazo, M.C., Bermejo-Barrera, A., Bermejo-Barrera, M.P., "Preconcentration of trace amounts of manganese from natural waters by means of a macroreticular poly(dithiocarbamate) resin," *Talanta*, **39**, (1992), 671.

- [54] Yebra, M.C., Moreno-Cid, A., "On-line determination of manganese in solid seafood samples by flame atomic absorption spectrometry," *Anal. Chim. Acta*, **477**, (2003), 149.
- [55] Stumm, W., Morgan, J.J., Aquatic Chemistry, Chemical Equilibria and Rates in Natural Waters, 3rd edition, John Wiley and Sons, USA, 1996
- [56] Florence, T.M., "The speciation of trace elements in waters," *Talanta*, **29**, (1982), 345.
- [57] Quddane, B., Martin, E., Boughriet, A., Fischer, J.C., Wartel, M., "Speciation of dissolved and particulate manganese in the Seine river estuary," *Marine Chem.*, **58**, (1997), 189.
- [58] Dođutan, M., Filik, H., Apak, R., "Preconcentration of manganese(II) from natural and sea water on a palmitoyl quinolin-8-ol functionalized XAD copolymer resin and spectrophotometric determination with the formaldoxime reagent," *Anal. Chim. Acta*, **485**, (2003), 205.
- [59] Özdemiř, Y., Güçer, Ő., "Speciation of manganese in tea leaves and tea infusions," *Food Chem.*, **61**, (1998), 313.
- [60] Aceto M., Abollino, O., Bruzzoniti, M.C., Mentasti, E., Sarzanini, C., "Speciation of copper and manganese in milk by solid-phase extraction/inductively coupled plasma-atomic emission spectrometry," *Anal. Chim. Acta*, **375**, (1998), 299.
- [61] Welz, B., Melcher, M., "Determination of antimony, arsenic, bismuth, selenium, tellurium and tin in metallurgical samples using the hydride AA technique- I. Analysis of low-alloy steels," *Spectrochim. Acta*, **36B**, (1980), 439.
- [62] Feng, Y.L., Narasaki, H., Chen, H.Y., Tian, L.C., "Speciation of antimony(III) and antimony(V) using hydride generation inductively coupled plasma atomic emission spectrometry combined with the rate of pre-reduction of antimony," *Anal. Chim. Acta*, **386**, (1999), 297.
- [63] Erođlu, A.E., M. Sc. Thesis, METU, Ankara, 1988.
- [64] Gökürk, G., Delzendeħ, M., Volkan, M., "Preconcentration of germanium on mercapto-modified silica gel," *Spectrochim. Acta Part B*, **55**, (2000), 1063.

- [65] Körez, A., Eroğlu, A.E., Volkan, M., Ataman, O.Y., “Speciation and Preconcentration of inorganic tellurium from waters using a mercaptosilica microcolumn and determination by hydride generation atomic absorption spectrometry,” *J. Anal. At. Spectrom.*, **15**, (2000), 1599.
- [66] Sahin, F., Volkan, M., Howard, A.G., Ataman, O.Y., “Selective preconcentration of selenite from aqueous samples using mercapto-silica,” *Talanta*, **60**, (2003), 1003.
- [67] Alfassi, Z.B., Wai, C.M., Preconcentration Techniques for Trace Elements, CRC Press Inc., Florida, 1992.