

**Industrial Product Design by Using Two-Dimensional  
Material in the Context of Origamic Structure  
and Integrity**

**By**

**Nergiz YIĞIT**

**A Dissertation Submitted to the  
Graduate School in Partial Fulfillment of the  
Requirements for the Degree of**

**MASTER OF INDUSTRIAL DESIGN**

**Department: Industrial Design  
Major: Industrial Design**

**İzmir Institute of Technology  
İzmir, Turkey**

**July, 2004**

We approve the thesis of **Nergiz YİĞİT**

**Date of Signature**

.....

**28.07.2004**

**Assist. Prof. Yavuz SEÇKİN**

Supervisor

Department of Industrial Design

.....

**28.07.2004**

**Assist.Prof. Dr. Önder ERKARSLAN**

Department of Industrial Design

.....

**28.07.2004**

**Assist. Prof. Dr. A. Can ÖZCAN**

İzmir University of Economics, Department of Industrial Design

.....

**28.07.2004**

**Assist. Prof. Yavuz SEÇKİN**

Head of Department

## **ACKNOWLEDGEMENTS**

I would like to thank my advisor Assist. Prof. Yavuz Sekin for his continual advice, supervision and understanding in the research and writing of this thesis.

I would also like to thank Assist. Prof. Dr. A. Can zcan, and Assist.Prof. Dr. nder Erkarlan for their advices and supports throughout my master's studies.

I am grateful to my friends Aslı etin and Deniz Deniz for their invaluable friendships, and I would like to thank to Yankı Gktepe for his being.

I would also like to thank my family for their patience, encouragement, care, and endless support during my whole life.

## ABSTRACT

Throughout the history of industrial product design, there have always been attempts to shape everyday objects from a single piece of semi-finished industrial materials such as plywood, sheet metal, plastic sheet and paper-based sheet. One of the ways to form these two-dimensional materials into three-dimensional products is bending following cutting. Similar concepts of this spatial transformation are encountered in the origami form, which has a planar surface in unfolded state, then transforms to a three-dimensional state by folding or by folding following cutting. If so, conceptually it may be useful to think of one-axis bending, which is a manufacturing technique, is somewhat similar to folding paper.

In this regard, the studies in the scope of computational origami, which light the way for real-world problems such as how sheets of material will behave under stress, have applications especially in ‘manufacturing phase’ of industrial product design. Besides manufacturing phase, origami design is also used as a product design tool either in ‘concept creating phase’ (in the context of its concepts) or in ‘form creating phase’ (in the context of its design principles).

In this thesis, the designing of industrial products, which are made from sheet material, is presented in a framework that considers the origami design. In the theoretical framework, evolutionary progression of origami design is discussed briefly in order to comprehend the situation of origami design in distinct application fields. Moreover, the elements, principles, basics of origami design and origamic structures are generally introduced. The theoretical framework is completed with the descriptions of the concepts on origami design and origamic structures. In the practical framework, typical applications that have origamic structures in distinct industrial product fields are exemplified. Furthermore, sheet materials and their bending process are taken up separately. By means of its excessive advantages, sheet metal bending is particularly emphasized. The practical framework is completed with several case studies base on sheet metal bending. Finally, the study is concluded with the evaluation of the origamic-structured product in respect of good design principles. Furthermore, designing by considering origami design is recommended to designer to design a good industrial product.

## ÖZ

Tasarım tarihi boyunca, gündelik objeleri tek bir parça kontraplak, metal levha, plastik levha ve kağıt esaslı levha gibi yarı ürünlerden biçimlendirme girişiminde bulunulmuştur. İki boyutlu bu levha malzemeleri üç boyutlu ürünlere dönüştürme yöntemlerinden birisi, kesmeyi takiben bükmedir. Buna benzer bir uzamsal dönüşüme, açılmış bir durumdayken düzlemsel bir yüzeyi olan, daha sonra katlayarak ya da kesmeyi takiben katlayarak üç boyutlu bir hale dönüştürülen origami yapılarında rastlanır. Öyleyse, bir imalat tekniği olan tek eksenli bükmenin kağıt katlamaya benzediğini düşünmek kavramsal olarak yararlı olabilir.

Bu bakış açısıyla, matematiksel origami kapsamında yer alan ve levha malzemelerin belli bir baskı altındaki davranışlarına açıklık getiren çalışmalar özellikle endüstri ürünleri tasarımının ‘imalat safhası’nda uygulama alanı bulmaktadır. Origami tasarımı, imalat safhasının yanısıra, hem ‘konsept tasarımı safhası’nda (tasarım konseptleri bağlamında) hem de ‘form tasarımı safhası’nda (tasarım prensipleri bağlamında) bir tasarım aracı olarak da kullanılır.

Dolayısıyla, bu tezde, levha malzemelerden yapılmış endüstri ürünlerinin tasarımı, origami tasarımını göz önüne alan bir çerçevede sunulmuştur. Teorik çerçevede, origami tasarımının farklı uygulama alanlarındaki konumunu kavrayabilmek için evrimsel gelişimine kısaca değinilmiştir. Ayrıca, origami tasarımının elemanları, prensipleri, esasları ve origami türündeki yapılar tanıtılmıştır. Teorik çerçeve, origami türündeki yapılara ve origami tasarımına dair kavramların betimlenmesiyle tamamlanmıştır. Pratik çerçevede, origami türü yapılara sahip tipik ürün uygulamaları farklı alanlara dair olmak üzere örneklenmiştir. Bunun yanında, levha malzemeler ve bükülme yöntemleri ayrı ayrı ele alınmıştır. Çok sayıda avantajı olduğu için, metal levhaların bükülmesi üzerinde özellikle durulmuştur. Pratik çerçeve, metal levhaların bükülmesine dayalı birkaç uygulama ile tamamlanmıştır. Çalışmanın sonunda, origamik yapıya sahip endüstri ürünleri ‘iyi tasarım prensipleri’ne göre değerlendirilmiş, daha da fazlası, iyi bir ürün tasarlayabilmeleri için, tasarımcıya origami tasarımını göz önünde alarak tasarım yapabileceği salık verilmiştir.

# TABLE OF CONTENTS

LIST OF FIGURES .....	ix
Chapter 1. INTRODUCTION.....	1
1.1. Definition of the Problem .....	1
1.2. Aims of the Study .....	1
1.3. Method of the Study .....	2
Chapter 2. NATURE OF ORIGAMI DESIGN AND ORIGAMIC STRUCTURE.....	4
2.1. Overview on Origami .....	4
2.1.1. The Origins of the Term ‘Origami’ .....	4
2.1.2. Evolution of Origami and Origami Design.....	5
2.1.3. Definition of Origami Design.....	12
2.2. Elements of Origami Design.....	13
2.3. Principles of Origami Design .....	16
2.4. Basics of Origami Design.....	19
2.4.1. Folding and Unfolding.....	19
2.4.1.1. Folding Geometries.....	21
2.4.1.2. Flat Foldability.....	23
2.4.1.3. Miura Ori Flat Folding Technique.....	24
2.4.1.4. Wrapping Fold .....	25
2.4.1.4. Unfolding and Flattening Polyhedra.....	25
2.4.2. Base.....	26
2.4.3. Crease Pattern .....	28
2.4.4. Origami Tessellations .....	28
2.5. Classification of Origamic Structure .....	30
2.5.1. Deployable (Transformable) Planar Structures .....	31
2.5.1.1. Pop-Up Structures.....	31
2.5.1.2. Biomimetic Folding Patterns .....	33
2.5.1.3. Deployable Cylinders .....	36
2.5.2. Modular Structures .....	37
2.6. Concepts on Origami Design and Origamic Structure .....	39

Chapter 3. ORIGAMIC STRUCTURED INDUSTRIAL PRODUCT.....	42
3.1 Definition of Origamic Structured Industrial Product .....	42
3.2. Overview on Origamic Structured Industrial Product .....	42
3.2.1. Origamic Structured Sheet Metal Products .....	43
3.2.2. Origamic Structured Plywood Products .....	48
3.2.3. Origamic Structured Plastic Sheet Products .....	50
3.2.4. Origamic Structured Paper Based Sheet Products.....	54
3.3. Forming Two Dimensional Material into Origamic Structured Product.....	56
3.3.1. Sheet Metal Bending Process .....	56
3.3.1.1. Designing Sheet Metal.....	59
3.3.1.2. Flat Processing (Shearing process).....	62
3.3.1.3. Sheet Metal Bending.....	64
3.3.2. Plywood Bending Process .....	67
3.3.3. Plastic Sheet Bending Process .....	70
3.3.4. Paper Sheet Folding Process.....	71
 Chapter 4. CASE STUDIES ON ORIGAMIC STRUCTURED PRODUCT .....	 74
4.1. Base.....	74
4.1.1. Problem Definition .....	75
4.1.2. Formal Description of Base .....	75
4.1.3. Functional Description of Base.....	79
4.2. Pure .....	81
4.2.1. Problem Definition .....	81
4.2.2. Formal Description of Pure.....	81
4.2.3. Functional Description of Pure .....	85
4.3. Leaf .....	87
4.3.1. Problem Definition .....	87
4.3.2. Formal Description of Leaf.....	87
4.3.3. Functional Description of Leaf.....	93
4.4. Triori .....	95
4.4.1. Problem Definition .....	95
4.4.2. Formal Description of Triori.....	95
4.4.3. Functional Description of Triori.....	98
4.5. Modulori .....	100

4.5.1. Problem Definition .....	100
4.5.2. Formal Description of Moduli.....	100
4.5.3. Functional Description of Moduli .....	103
4.6. Windrose .....	105
4.6.1. Problem Definition .....	105
4.6.2. Formal Description of Windrose .....	106
4.6.3. Functional Description Of Windrose .....	108
4.7. Radius .....	109
4.7.1. Problem Definition .....	110
4.7.2. Formal Description of Radius.....	110
4.7.3. Functional Description Of Radius .....	110
 Chapter 5. CONCLUSION .....	 112
 REFERENCES .....	 115



## LIST OF FIGURES

Figure 2.1. The earliest origami models .....	5
Figure 2.2. Reference pages to ‘Kirigami’ .....	6
Figure 2.3. ‘Tsurifune’ the large folded crane suspended from a chain of small folded cranes .....	7
Figure 2.4. Paper cutting and folding examples from Bauhaus Preliminary Course.....	8
Figure 2.5. Curved line folding.....	10
Figure 2.6. Crease pattern constituted by Treemaker Program to form a lizard.....	11
Figure 2.7. Crease patterns constituted by Treemaker Program for Kirigami.....	11
Figure 2.8. Tessellation constituted by Tess Program .....	11
Figure 2.9. Crease pattern of a crane. ....	15
Figure 2.10. Two most common kinds of symmetry .....	17
Figure 2.11. Samples of rotational symmetries .....	17
Figure 2.12. The pattern constituted by rotational and reflection symmetries .....	18
Figure 2.13. Isometries .....	18
Figure 2.14. Seventeen symmetry groups.....	19
Figure 2.15. Basic Folds .....	20
Figure 2.16. Huzita's six Origami axioms.....	20
Figure 2.17. Natural folding geometries of square and rectangle.....	22
Figure 2.18. Geometrically folded structures .....	23
Figure 2.19. Sample of non-flat foldable form .....	23
Figure 2.20. A flat-foldable vertex .....	24
Figure 2.21. Miura Ori Map Folding .....	24
Figure 2.22. Wrapping Fold around a central circular hub.....	25
Figure 2.23. Wrapping Fold around a central prismatic hub .....	25
Figure 2.24. Unfolding of an octahedron.....	26
Figure 2.25. Flattening a tetrahedron, from left to right.....	26
Figure 2.26. Flat foldable Origami bases.....	27
Figure 2.27. Polyhedral bases of modular origami .....	27
Figure 2.28. Crease pattern .....	28
Figure 2.29. Pre-creasing and twist folding.....	29
Figure 2.30. Tessellation groups.....	29
Figure 2.31. Tessellations designed by Enlai Hooi .....	30

Figure 2.32. Pop-up structures .....	32
Figure 2.33. Additional pop-up effects by folding .....	33
Figure 2.34. Unfolding manner of hornbeam leaves .....	34
Figure 2.35. Stages in making 'ha-ori' (leaf-folding) .....	34
Figure 2.36. The leaf-folding structure extends simultaneously in two directions.....	34
Figure 2.37. Leaf patterns. ....	35
Figure 2.38. The deployment of leaf patterns paper model, in four stages .....	35
Figure 2.39. Deployment of a cylinder .....	36
Figure 2.40. Modular patterns.....	37
Figure 2.41. Two Fold Star .....	38
Figure 2.42. Modular surfaces .....	38
Figure 2.43. Modular structures.....	39
Figure 3.1. '2D:3D' Office accessories and racks designed by Charlie Lazor, 1999.....	43
Figure 3.2. Square Dance Low Table, designed by Ronen Kadushin, 2000 .....	44
Figure 3.3. Piclip, designed by Chris Smith, 2002 .....	44
Figure 3.4. Prismatic Table, designed by Isamu Noguchi, 1957 .....	45
Figure 3.5. Fly, designed by Mehmet Ermiyagil, 2004 .....	45
Figure 3.6. Tufold, By Scot Laughton .....	46
Figure 3.7. Origami P1 Table, designed by Mehmet Ermiyagil, 2004.....	46
Figure 3.8. Noan, designed by Gualtiero Sacchi, 2004 .....	47
Figure 3.9. Diana side table series, Red Dot Award: Product Design 2002, designed by Konstantin Grcic, 2002, Manufacturer: ClassiCon.....	47
Figure 3.10. Plywood Armchair, designed by Gerald Summers, 1934 .....	48
Figure 3.11. Capelli Stool, IDEA Industrial Design Excellence Award 2002: designed by Carol Catalano, 2002 .....	49
Figure 3.12. Bend Table, designed by Mehmet Ermiyagil, 2000.....	49
Figure 3.13. Voxia series, designed by Peter Karpf, 2000 .....	50
Figure 3.14. Fluent, designed by Studio Platform .....	51
Figure 3.15. Self Lock Kaki, designed by Naoko Takeda, 2000 .....	51
Figure 3.16. City Knife II, by Kirsten Schambra, 1998, Manufacturer: Nike.....	52
Figure 3.17. Flat Foldable Sandal .....	53
Figure 3.18. Acrylic series, designed by David Ross, 2001 .....	53
Figure 3.19. Folder Coffeetable , designed by Ole Petter Wullum & Arnstein Sarset...	54
Figure 3.20. Flov Series, designed by Mirzat Koç, 2003 .....	54

Figure 3.21. Spotty child's chair, designed by Peter Murdoch, 1963 .....	55
Figure 3.22. Sturdy paper pot, designed by Tomoko Fuse .....	55
Figure 3.23. The same pieces despite different functions.....	58
Figure 3.24. Sheet Metal forming process.....	58
Figure 3.25. Saving material by using an optimized placement strategy .....	60
Figure 3.26. Rounding outer and inner corners .....	60
Figure 3.27. Notching the bending zones .....	60
Figure 3.28. Bend Radius .....	61
Figure 3.29. Elongated length.....	62
Figure 3.30. Resiliency (spring back).....	62
Figure 3.31. Various shearing operations .....	63
Figure 3.32. Bending process phases.....	64
Figure 3.33. Special punch and dies for sheet metal bending.....	64
Figure 3.34. V bending styles .....	65
Figure 3.35. Special Bending Operations. ....	66
Figure 3.36. Most common forms .....	67
Figure 3.37. Cross-layered structure of plywood .....	67
Figure 3.38. Foiled and laminated plywood .....	68
Figure 3.39. The EL Plywood Desk was designed by Sheila Kennedy, Developed with support from the U.S. Department of Energy .....	68
Figure 3.40. Plywood bending process.....	69
Figure 3.41. Hot line bending by manually .....	70
Figure 3.42. Hot line bending with bending machine.....	71
Figure 3.43. The principle of scoring .....	72
Figure 3.44. Working principle of 'Buckler' Folding Machine .....	72
Figure 3.45. Working principle of 'Knife' Folding Machine .....	72
Figure 4.1. Product Proposal 1: Base.....	74
Figure 4.2. One unit form' Of Base that will be repeated .....	75
Figure 4.3. Constituting the pattern by considering symmetry principal .....	76
Figure 4.4. Crease pattern of Base .....	76
Figure 4.5. Bending Sequence Of Base .....	77
Figure 4.6. Technical Drawings Of Base (measures: mm, scale: 1/20).....	78
Figure 4.7. Magazine holder function of Base.....	79
Figure 4.8. Coffee table function of Base .....	79

Figure 4.9. Stockability.....	79
Figure 4.10. Graphical effect that adds emotional appeal .....	79
Figure 4.11. Perspective Preview 1 of Base .....	80
Figure 4.12. Perspective Preview 2 of Base .....	80
Figure 4.13. Product Proposal 2: Pure .....	81
Figure 4.14. Unit Forms of Pure .....	82
Figure 4.15. Crease pattern of Pure .....	82
Figure 4.16. Bending sequence of Pure .....	83
Figure 4.17. Technical drawings of one unit Pure in unfolded state .....	83
Figure 4.18. Technical Drawings Of Pure in folded state .....	84
Figure 4.19. Stocking Function.....	85
Figure 4.20. Low table function.....	85
Figure 4.21. Stockability Of Pure .....	85
Figure 4.22. Perspective Preview 1 of Pure.....	86
Figure 4.23. Perspective Preview 2 of Pure.....	86
Figure 4.24. Product Proposal 3: Leaf .....	87
Figure 4.25. Patterns Constituted By One Leaf Unit.....	88
Figure 4.26. Crease pattern of one Leaf unit .....	89
Figure 4.27. Bending Sequence Of One Leaf Unit.....	90
Figure 4.28. Technical Drawings of Patterns Constituted By One Leaf Unit .....	91
Figure 4.29. Technical Drawings Of one Leaf unit (measures: mm, scale: 1/20).....	92
Figure 4.30. Stockability.....	93
Figure 4.31. Multipurpose of Leaf unit.....	93
Figure 4.32. Perspective Previews of Three Leaf Units (first alternative) .....	93
Figure 4.33. Perspective Previews of Two Leaf Units (first alternative) .....	94
Figure 4.34. Perspective Previews of Two Leaf Units (second alternative).....	94
Figure 4.35. Perspective Previews of Three Leaf Units (second alternative).....	94
Figure 4.36. Product Proposal 4: Triori .....	95
Figure 4.37. One Unit Form and Three Units Form of TriOri.....	96
Figure 4.38. Crease pattern of Triori .....	96
Figure 4.39. Technical Drawings Of TriOri (measures: mm, scale: 1/20).....	97
Figure 4.40. Multipurpose of Triori in erected state.....	98
Figure 4.41. Multipurpose of Triori in unerected state.....	98
Figure 4.42. Flat packaging of Triori.....	98

Figure 4.43. Perspective Preview 1 of TriOri.....	99
Figure 4.44. Perspective Preview 2 of TriOri.....	99
Figure 4.45. Product Proposal 5: Modulori .....	100
Figure 4.46. Crease Pattern Of ModulOri.....	100
Figure 4.47. Bending sequence of ModulOri .....	101
Figure 4.48. Technical Drawings of One unit ModulOri in unfolded state.....	101
Figure 4.49. Technical Drawings Of ModulOri (measures: mm, scale: 1/20) .....	102
Figure 4.50. Multipurpose of ModulOri .....	103
Figure 4.51. Four Units Form Of ModulOri (first alternative).....	103
Figure 4.52. Four Units Form Of ModulOri (second alternative) .....	103
Figure 4.53. Two Units Form Of ModulOri (first alternative) .....	104
Figure 4.54. Two Units Form Of ModulOri (second alternative) .....	104
Figure 4.55. One Unit Form Of ModulOri .....	104
Figure 4.56. Perspective Previews of ModulOri.....	105
Figure 4.57. Product Proposal 6: Windrose.....	105
Figure 4.58. Crease Pattern Of Windrose .....	106
Figure 4.59. Bending sequence of Windrose.....	106
Figure 4.60. Technical Drawings of One unit Windrose in unfolded state .....	106
Figure 4.61. Technical Drawings of Windrose.....	107
Figure 4.62. Multipurposes Of WindRose.....	108
Figure 4.63. One Unit Form Of WindRose .....	108
Figure 4.64. Two Units Form Of WindRose .....	108
Figure 4.65. Four Units Form Of WindRose .....	108
Figure 4.66. Perspective Previews of WindRose.....	109
Figure 4.67. Radius Office Systems, Delta Office Systems Design Competition 2003: Honorable Mention, designed by Nergiz Yiğit, 2003.....	109
Figure 4.68. Bending of Radius .....	110
Figure 4.69. Technical Drawings of Radius .....	110
Figure 4.70. Alternative combinations of Radius.....	111

# CHAPTER 1

## INTRODUCTION

### 1.1 Definition of the Problem

When constituting a pattern to structure a form, nature knows no interruption of materials and surfaces in order to achieve the economy of materials, methods and purpose. By imitating these concepts of the nature, in designing, the planar surface are use to create stable spatial structures and/or dynamic surface movement to achieve the concept of 'unity' and 'wholeness' or to integrate the parts, which are formed from planes, into a seamless whole. Consequently, designing with planar surface have always been challenging to designers 1920's onwards. Especially the contemporary designers of 2000's are seized by the tendency of constituting a space from continuous surfaces by bending, curving and folding. Today, it gains popularity designing the products, which let the separate elements are unified as continuous features. In such a way, a shelf system and a desk or a seating and its base become a unified whole.

The similar way to form the two-dimensional industrial materials into three-dimensional products is encountered in the origami design. If so, it is useful to think considering the origami design techniques, principles, and concepts can assist in the designing of an industrial product from two-dimensional material.

To comprehend the intellectual properties that are needed for origami design, it must be clearly discussed in detail, and to understand the product, which is designed by assisting origami design, and the production techniques of this product are taken up by exemplifying.

### 1.2 Aims of the Study

The fundamental aim of the thesis is to clarify how origami design assists to design an industrial product what the outcome of design by considering origami design is. By regarding this, it is aimed to define the nature of origami design and origamic structure in second chapter.

If the form of a product is to some degree the result of how it was manufactured, it follows that the designer must have a good understanding of all manufacturing

processes available, in order to have confidence that the proposed manufacturing process is the most economical and appropriate. If designers are unaware of certain available processes, they will be limited in their creative potential. With a good knowledge base, the designer can propose an array of possible design solutions and have some confidence that they can be manufactured.

In order to design for high productivity and also to achieve high quality and controllable material cost, designer should consider the simplification and size reduction possible in product, and the maximum reduction possible in the number of component parts. Designer should be aware of the capabilities, particularly of new materials, of performing multifunctional roles in a product. In this regard, the third chapter is aimed to have a characteristic, which is an overview of the key manufacturing process related to two-dimensional materials such as metal sheet, plastic sheet and plywood. However it is limited with flat processing and bending in order to compromise with the context of this thesis. Furthermore, in this chapter, it is aimed to clarify how the techniques of origami design are adapted in manufacturing process and what characteristics of the origamic-structured products are.

It is aimed in forth chapter, to apply the concept, principles, and techniques of origami design into a product made from sheet metal by press brake bending. In the conclusion, it is aimed to evaluate the origamic-structured product.

### **1.3 Method of the Study**

The study is comprised of five chapters. In the first introductory chapter, the aims and means of the study are defined.

In the second chapter on the nature of the origami design and origamic structure, origami design is defined and its evolution are mentioned in order to comprehend its application in distinct design field. Moreover, in order the use it as a design tool in 'form creating phase', the elements, principles, and basics of origami design are discussed in detail. And finally origamic structures are classified.

The third chapter on origamic structured industrial product is constituted from four main sections. In the first section, the term 'origamic' is defined and what the origamic structured industrial product is determined. In the second section, the concepts on origami design and origamic structure are taken up in order to use its concepts in 'concept creating phase'. The comprehensive exemplifying of origamic structured

industrial products in distinct product fields constitutes the third section. In the fourth section, the adaptation of the folding techniques to forming processes in manufacturing phase are discussed separately for sheet metal, plywood and plastic sheet.

The fourth chapter consists of several case studies that base on the synthesis of previous chapters. In such a way that, these case studies are designed by considering origami design principles, concepts and techniques, and the proposed designs are made from sheet metal and formed by one-axis bending.

In the conclusion, on the basis of the exemplifying in the third chapter, the typical characteristics of the origamic-structured products are determined, and then evaluated by considering good design principles. Consequently, it is recommended to designer that, it is useful to think of designing by considering origami design makes way for good design, guide the designer in this way, and usually brings outcomes about good design.



## CHAPTER 2

### NATURE OF ORIGAMI DESIGN AND ORIGAMIC STRUCTURE

“Folding is an art of seeing something not seen, something not already there”

John Rajchman

#### 2.1 Overview on Origami

In order to comprehend its application in distinct design field, the nature of the origami design and origamic structures had been defined and its evolution had been mentioned in this chapter. Moreover, in order the use it as a design tool in ‘form creating phase’, the elements, principles, and basics of origami design had been discussed in detail.

##### 2.1.1 The Origins of the Term ‘Origami’

‘Origami’ is a Japanese word, which combines the verb ‘oru’ to fold, and the noun ‘kami’ paper. Quoting from Merriam Webster’s Third New International Dictionary, origami means:

1. The art of Japanese paper folding.
2. Something as a representative made by origami.

The term origami was first mentioned during the seventh century A.D in Japan. It referred to square and rectangular pieces of paper folded into symbolic representations of the spirit of God, and hung at the shrines as objects of worship. During the eleventh century A.D. folded paper came to be used for certain special documents, such as diplomas for Tea Ceremony masters, or masters of swordsmanship; in such a way that to prevent unauthorized copies from being made. This certificate had the same meaning as the word ‘diploma’, which also means ‘a letter folded in two’ in Latin. The term origami referred to the ‘documents’, whereas the term ‘origami tsuki’ referred ‘certified’.

The use of the term origami for recreational paper folding did not appear until the end of the nineteenth century. Before this time, paper folding was known by a

variety of names such as orikata, orisue, orimono, and tatamgami. It is suggested that the word origami was a direct translation of the German word ‘papierfalten’, brought into Japan with the Kindergarten Movement (Lister, 1998, p. 2).

### 2.1.2 Evolution of Origami and Origami Design

Origami is traditionally associated with Japanese culture. However, it is originated in China with the invention of paper in 105 A.D. The Japanese learned about paper making in the early seventh century from a Buddhist Monk who came to Japan from China. In spite of its rapid diffusion, paper remained for years a rare and precious material, and used for religious ceremonies and important occasion.

#### Classical Origami

In Japan, paper folding was a ceremonial tradition of the nobility in nature. The earliest representational origami designs are a male butterfly ‘o-cho’ (Figure 2.1.a), and a female butterfly ‘me-cho’ hanged to the sake bottles during the ‘Shinto’ ceremonial weddings in Heian period (794 – 1185). Besides, a folded paper sheet shown in Figure 2.1.b was used to cover the sake bottle on the altar during Shinto.

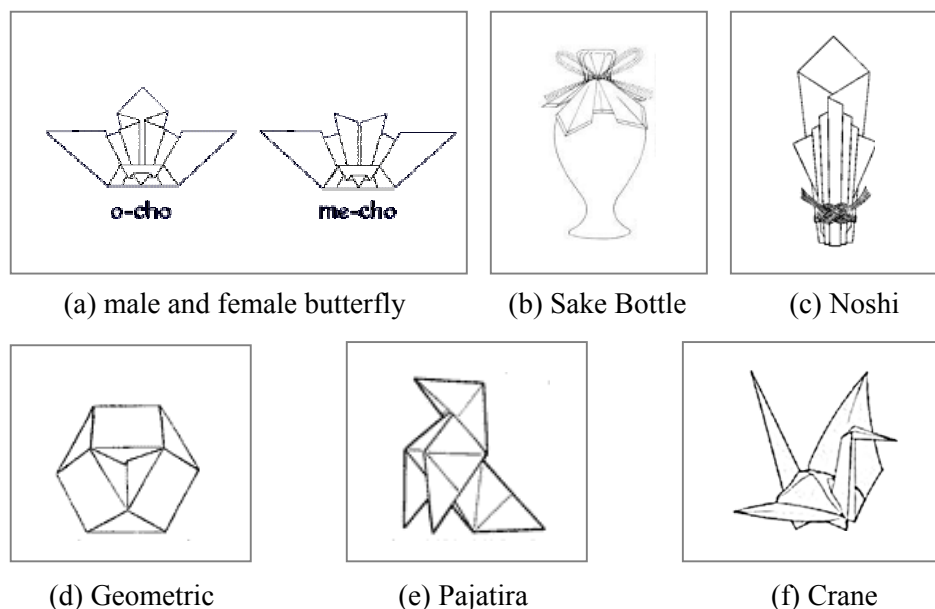

Figure 2.1: The earliest Origami models, (<http://www.origami-cdo.it/articoli/storigen.htm>)

‘Noshi’ shown in Figure 2.1.c, is the most important origami model in Kamakura period (1185 - 1333). It is a kind of ceremonial fold that accompanied with

valued objects such as swords or gifts presented to others, and entirely distinct from ‘origami-tsuki’ in such a way that it was not certificate, but was attached to gifts to express good wishes. It differs from other traditional models, so that is obtained by a simple fold, without any cut. Later on, this tendency shall become predominant in the so-called pure origami (Honda, 1965, p. 3).

In the eighth century, papermaking and origami was spread out through the Silk Route to the Near East. Since Muslim religion proscribed the making of representational figures like human and animal forms, Arab mathematicians and astronomers were interested in the geometry of tessellation and the folding properties of the square, thus they explored geometric constructions such as the one shown in Figure 2.1.d (Crankshaw, 2001, p. 2).

In the twelfth century, the Moors, who are the Muslims of North Africa, brought paper folding to Spain. The Spanish incorporated the representational forms of nature to paper folding. The little bird ‘Pajarita’ shown in Figure 2.1.e. is the most known model of Spanish creation. During the sixteenth and seventeenth centuries, folding table napkins into elaborate models of animals and ships were the sign of the great nobility in the palaces of royalty. It is also known that pleated folding of cloth existed in the West during Egyptian, Greek, Roman and Byzantine periods (Leonardi, 1997).

The oldest surviving publications about origami come from Edo period (1603 - 1867) in Japan. The Japanese book ‘Wakoku Chiyekurabe’, the so-translated Mathematical Contents in English, is the first published reference to fold-and-cut idea, the so-called ‘Kirigami’ in Japanese. This book, dated in 1721 and written by Kan Chu Sen, contains a variety of problems for testing mathematical intelligence. Some sample pages from Wakoku Chiyekurabe are shown in Figure 2.2 (Demaine, 1998, p. 105).

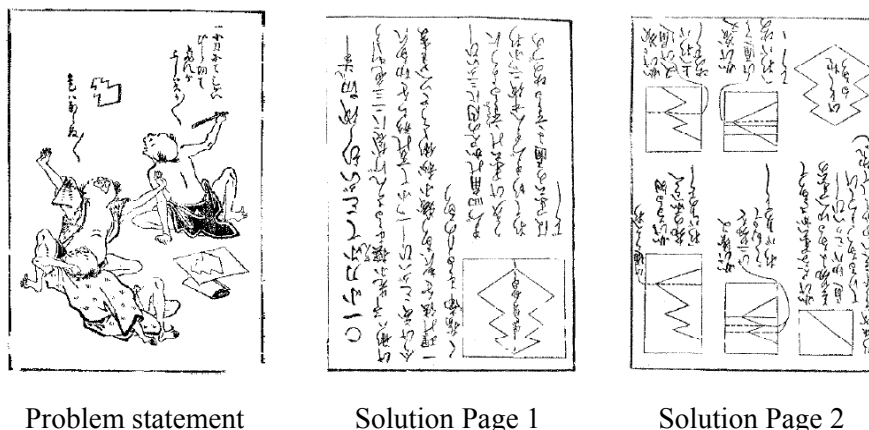

Figure 2.2: Reference pages to Kirigami, (Demaine, 1998, p. 106)

Another book ‘Senbazuru Orikata’, the so-translated How to Fold One Thousand Cranes in English, was written by Akisato Rito and published in 1797. The ‘Tsurifune’ model shown in Figure 2.3, an example from Senbazuru Orikata, is a specialized work on folding a sheet of paper, which is cut into various combinations of smaller squares linked at the corners, to a linked sets of large and small classic cranes. Also, the book ‘Kan No Mado’ written by Adachi Kazuyuki, the so-translated Window On Midwinter in English, which is the first comprehensive collection of origami figures with a lot of cuts, published in same period in 1845.

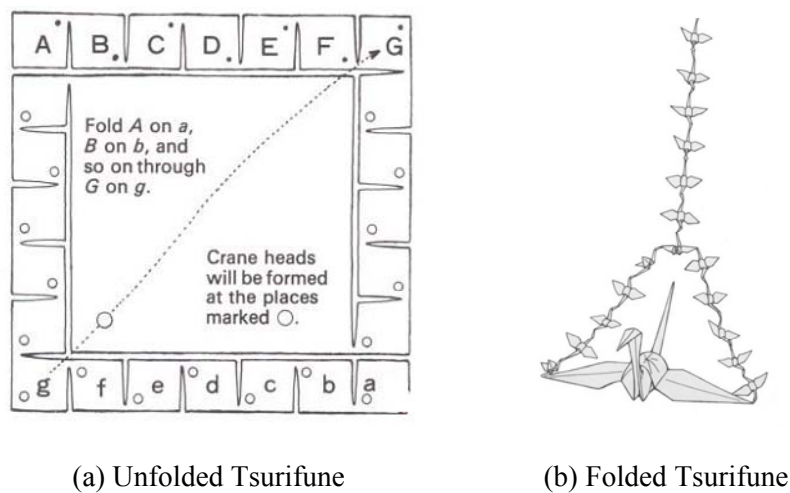

Figure 2.3: ‘Tsurifune’ the large folded crane suspended from a chain of small folded cranes (Kasahara & Takahama, 1998, p. 18)

The characteristic of classical origami is that it uses a deep symmetry both in the paper and the bases. The models of European classic origami were based on creases of 45 degrees (see Figure 2.1.e), whereas Japanese ones were based on those of 22.5 degrees (see Figure 2.1.f). In addition, Japanese ones contained lots of cutting, although European fold without any cuts. Besides, in classical origami, the folding sequences were passed down as something anonymous, not as something made up by a specific person.

### Traditional Origami

Global trade introduced Japanese aesthetics to the rest of the world during the nineteenth century, thus origami gained popularity steadily, and also has been used as educational and scientific tools.

The influential educator Friedrich Froebel introduced the paper folding to the kindergarten movement in Germany around 1835. It was stated in this movement that the purpose of education was to demonstrate the unity of the universe through a set of symbolic activities promoting cooperation, the study of nature, and the manual work to unite brain and hands. Because of paper folding allows students to manipulate geometric figures physically, and illustrates developing the basic concepts of a point, a line, and a plane, it has also been used as a tool in mathematic education.

Paper is a fragile substance; but when cut and folded in certain ways it can become remarkably strong and rigid. Insights gained from experimentation with sheets of paper, metal and other materials are of obvious relevance to every kind of design activity. Because of these attributes, paper folding and cutting has been used to teach important lessons about the nature of construction in design education since 1925. Josef Albers, a famous designer of Bauhaus Movement who was fascinated by the properties of materials and their potential when shaped, encouraged the students to manipulate paper by folding and cutting in Bauhaus Preliminary Courses. Examples of pop-up organic architecture cutouts and origami constructions including tessellations shown in Figure 2.4 were created by Bauhaus students and designers in 1930s (Whitford, 1995, p. 133).

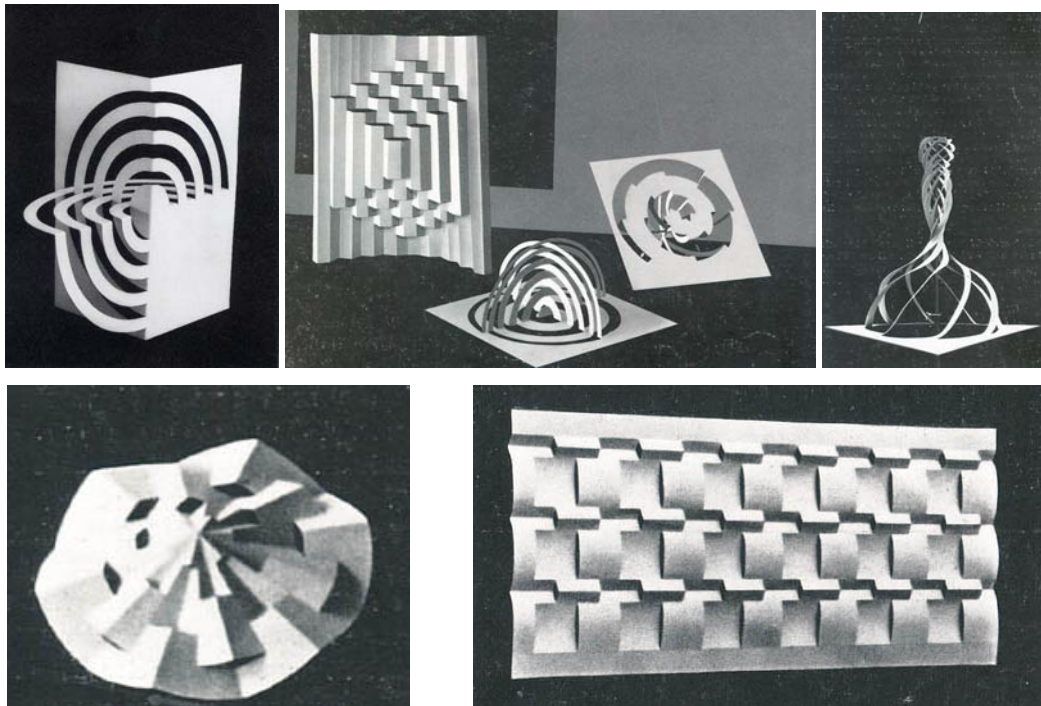

Figure 2.4: Paper cutting and folding examples from Bauhaus Preliminary Course, (Wingler, 1975, pp. 411-412)

## **Modern Origami**

At second half of the twentieth century, the modern approach to Origami explored new bases and intensified to geometric folding and the employment of modules. Besides, the origami books of Japanese, European, and American designers were published in both Japanese and English. It is stated in these references that the diagrams, which represent the folding sequence of a model, are important in modern origami. As they represent the model itself, besides are supposed to show the entire sequence in order to being reproductive. The idea that particular persons have intellectual property in folding sequences is also a typical of modern origami.

In 1950s and 1960s, an international origami circle was established by the creators and folders such as Yoshizawa Akira, Takahama Toshie, Honda Isao, Robert Harbin, Gershon Legman, Lillian Oppenheimer, Samuel Randlett, and Vicente Solórzano-Sagredo. National and local organizations, and also many societies, such as the International Origami Society by Akira Yoshizawa, have been founded. Besides, Yoshizawa's notation of diagrams was adopted by Harbin and Randlett, and became an international standard. And also, 'Origami' became a universal word in this era.

## **Recent trend: Computational (mathematical) Origami**

Origami has come a long way from cute little birds and decorative objects. Around 1980s, mathematicians and scientists have begun mapping the laws that underlie folding, converting words and concepts into algebraic rules. The principles of computational geometry have been excessively applied to origami design, and also axioms, which explain how the three-dimensional objects are created from a flat material by folding, have been formulated.

One of these axioms was the 'critical pi condition', discovered by the scientist Dr. David Huffman. It is explained as, if there is a point or vertex surrounded by four creases, to fold the form flat, then opposite angles around the vertex must sum to 180 degrees. Afterwards, that condition was reorganized by Kawasaki and generalized for more than four creases. Today it is known as Kawasaki Theorem, described in section 2.4.1.2, that is the most important theorem on flat fold ability (Wertheim, 2004).

In contrast to classical and traditional origami, where all folds are straight, the structures based on curved folds have been developed in computational origami by obeying the rule no cuts or glue. The theme of minimal surface that the form soap

bubbles make, was carried into origami by Dr. Huffman, in a way that based on curves derived from conic sections, such as the hyperbola and the ellipse. Some examples of curved form, which are folded from a single sheet of paper by Dr. Huffman, are shown in Figure 2.5.

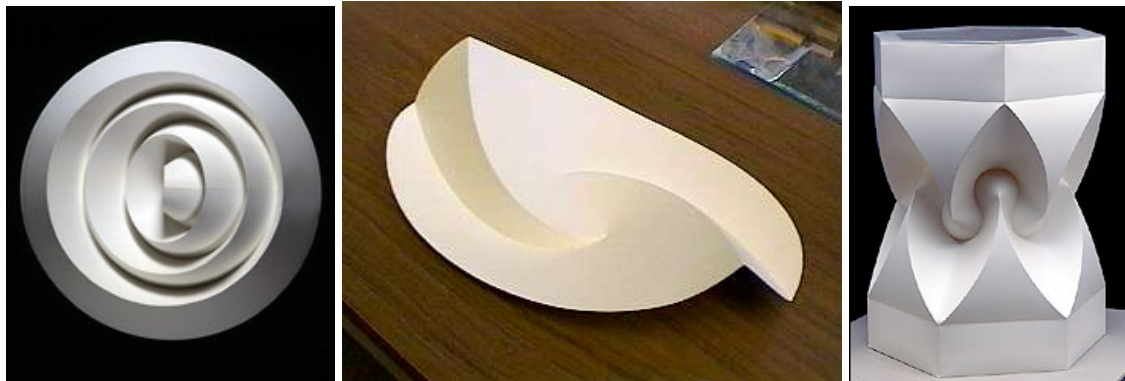

(a) An origami form of concentric domes

(b) 4 parabolic curved folds through center

(c) A tower-like paper structure

Fig 2.5: Curved line folding, (<http://www.NYTimes.com>, June 22<sup>nd</sup>, 2004)

Besides the studies on curved lines, studies with straight lines also led to the invention of new bases in computational origami. Origami designers Maekawa Jun and Peter Engel divided the crease patterns into particular triangles and rectangles, and then, rearranged these atoms to make new crease patterns. By means of these studies, an advanced algorithm that generates the crease pattern of the base from an arbitrary length and arrangement of areas, was developed by Meguro Toshiyuki, Kawahata Fumiaki, and Robert Lang. TreeMaker computer program devised by Robert Lang in 1993 supports the origami design based on this algorithm (Demaine, 2001, p. 20).

**TreeMaker** is a tool for origami design. Starting from a description of a desired origami model, TreeMaker computes a crease pattern for folding a base for the model from an uncut square of paper. It implements the ‘tree method’ for origami design. The tree method allows designing an origami base in the shape of a specified tree with desired edge lengths, which can then be folded and shaped into an origami model. It suggests a method for finding an appropriate mountain-valley assignment for the crease pattern, and also aims to make optimal use of the paper to create a base for a given figure with the smallest possible square of paper, or, conversely, to make the largest possible base from a given square (Cipra, 2001, p. 3).

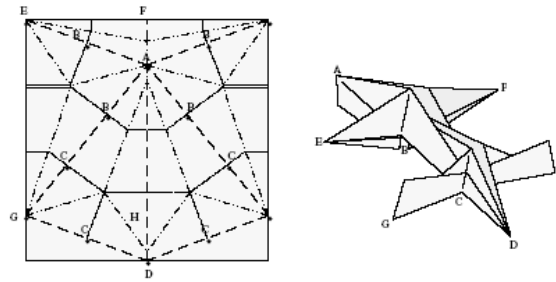

Figure 2.6: Crease pattern constituted by Treemaker to form a lizard, (Lang, 1998, p. 22)

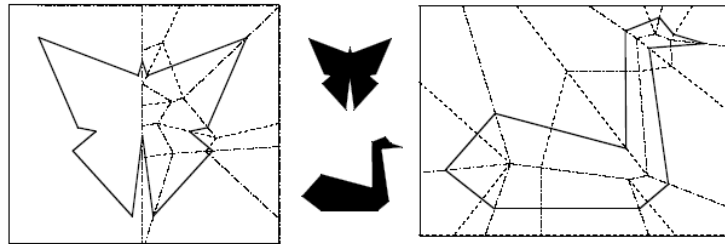

Figure 2.7: Crease patterns constituted by Treemaker for Kirigami, (Demaine, 1998, p. 108)

**Tess**, developed by a biochemist Alex Bateman, is another computer program for designing flat-folding origami. This program creates crease patterns for origami tessellations like shown in Figure 2.8. The user is free to specify the underlying symmetry group and vary key parameters. In theory, these tessellations are easy to fold by twisting one part of the paper over another (Cipra, 2001, p. 4).

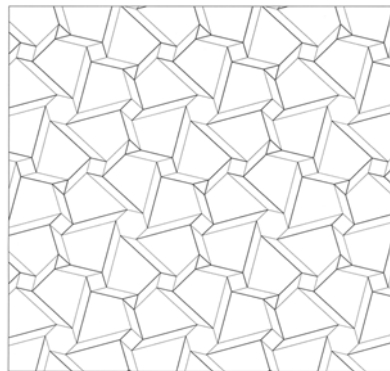

Figure 2.8: Tessellation constituted by Tess Program (Cipra, 2001, p. 4)

Besides Treemaker and Tess, there has been a constant growing of software tools to aid the design of origami. **3D Card Maker**, developed by Jun Mitani, generates crease and cut lines for one-piece pop-up structures, and it is capable of creating and animating the double slit (discussed in section 2.5.1.1). **HyperGami**, developed by



Nishioka and Eisenberg, is software for creating polyhedral models, and also another program **Mathematica** is able to simulate folding steps (Lee, 2003, p. 2).

By means of these computer programs and the developments on computational origami, origami design also drive a force to electronic engineers for folding processors in order to stock maximum amount of information into the smallest possible area, and help to biologists about creating properly folded artificial proteins, and also figure out how to most effectively fold and unfold a roadmap, how to unfold a telescope lens in outer space without damaging it, and determine the safest way to stow an airbag within a steering column (Cipra, 2001, p. 2).

Consequently, computational origami, also known as technical folding or origami sekkei, intends creating flat foldable forms by assistance of computational geometry, number theory, coding theory and linear algebra.

Computational origami concerns the studies on the structures that are folded to avoid putting strain on the paper or the relationships of the angles that prevent stretching and tearing in the case of multiple folds coming into a point, which light the way for real-world problems such as pressing or bending sheet metal. The studies are closely relevant to how sheets of other material will behave under stress (Wertheim, 2004).

Thanks to its evolutionary progression, origami design has also been applied to industrial product design problems mostly in the field of packaging, domestic or office furniture and accessory. It is a design tool used in either concept-creating phase in the context of its concepts arise from the nature of origami design, or form-creating phase by concerning manufacturing processes in the context of its principles and techniques used to form two-dimensional material into three-dimensional object.

### **2.1.3 Definition of Origami Design**

Origami design is defined as “forming a piece of two-dimensional medium into a particular form with certain desired properties by folding and cutting” (Demaine, 2001, p. 21). In the point of purist view, this particular form achieved by only straight line folding of a single color square piece of medium in a deep symmetry; whereas in the point of non-purist view, cutting and slitting besides straight or curved line folding is used to form multi-colored mediums (in order to obtain more graphical effect) with variable outline (in order to obtain certain properties).

An origami form is a collection of ‘planes’ in an order. If so, an origami is represented as a list {planes, order}. A plane is represented as a list {poly, neighbors, mpoints}, where ‘neighbors’ is a list of neighboring planes; ‘mpoints’ is a list of marked points determine a line; ‘poly’ is a polygon consisting of vertices that is represented in two ways: vertex representation and edge representation. An origami is folded along a line called crease. The crease can be determined by the line, which it passes through (Takahashi, 2002, p. 3). Consequently, an origami is represented by points, lines and polygonal planes.

In origami design, a plane is used to create stable spatial structures or dynamic surface movement that integrate parts into a seamless whole. If so, the unfolded state of an origami form is two-dimensional, furthermore creating crease pattern and tessellations involves two-dimensional thinking. In other words, origami design is a three-dimensional design, which is obtained through two-dimensional design.

Between two-dimensional thinking and three-dimensional thinking, there is a difference in attitude. Three-dimensional design requires the capability of visualizing mentally the whole form and rotating it mentally in all directions, and also exploring the impact of mass, the nature of different materials, the flow of space and depth thoroughly. Besides inevitable necessity of both two-dimensional and three-dimensional thinking, designing origami also requires the creator to function in two roles simultaneously; as a designer and as an engineer. Not only the appearance of the completed model must be concerned, but also the strategic decisions on how to proceed with the construction of the form must be taken. Consequently, it is no doubt that designing origami is extremely challenging and requires intellectual property (Nolan, 1995, p. 3).

## **2.2 Elements of Origami Design**

### **Point, line, plane and volume**

Point, line, plane and volume are basic elements of origami design. If a point moves in an unchanging direction, from a starting position, a trace of its path describes a line, the so-called first dimension. Moving the line any other than the first direction describes a planer trace, the so-called second dimension. The planer trace of the third change in direction describes a solid so-called third dimension (Critchlow, 1969, p. 4).

Point, line, plane, and volume are the conceptual elements; whereas shape, color and texture are the visual element and position, direction, and space are the relational elements of two-dimensional design. In addition to these elements, there is a set of constructional elements that proves concrete realizations of the conceptual elements in three-dimensional design. Vertex, edge, faces are the constructional elements that assist to define volumetric forms precisely, and these elements are used to indicate the geometric components of three-dimensional design. When several planes come to one conceptual point, vertex is obtained. When two nonparallel planes are joined together along one conceptual line, an edge arises. Faces are external surfaces, which enclose a volume. Constructional elements have strong structural qualities and are particularly important for the understanding of geometric solids, in other words polyhedral volumes, such as Platonic, Archimedean or Kepler-Poinsot solids (described in section 2.4.2), which are the bases that constitute an origami form (Wong, 1993, pp. 241-245).

An origami form that created in the point of purist view has straight lines, polygonal planes, and polyhedral volume with a unique color and homogeneous texture, whereas, an origami form created in the non-purist view might have both curved and straight lines, and also organic and non-polyhedral volume with multi color and heterogeneous texture specially.

### **Geometry, proportion and order**

An origami form is constituted by patterns that are the repeating of similar geometric shapes, for instance polygons. These patterns are created by concerning the intellectual properties of geometry, proportion and order. “The term of geometry is used to describe any proportional system or positional manipulation on a surface or in space” (Johnson, 1994, p. 357). In origami design, geometry is used for determining the spatial relationship and the resolution of space. In other words, geometry is the interpretive aspect of the order. Order is the overlap relation between the planes that constitute the origami. Furthermore, it is the arrangement of the proportion with a view to a symmetrically result, which supports integration. “In design, proportion is a correspondence among the measures of the whole to a certain part selected as standard” (Johnson, 1994, p. 370). Proportion denotes the feeling of unity and rightness when the physical relationship between the planes of origami form correspondence each other.

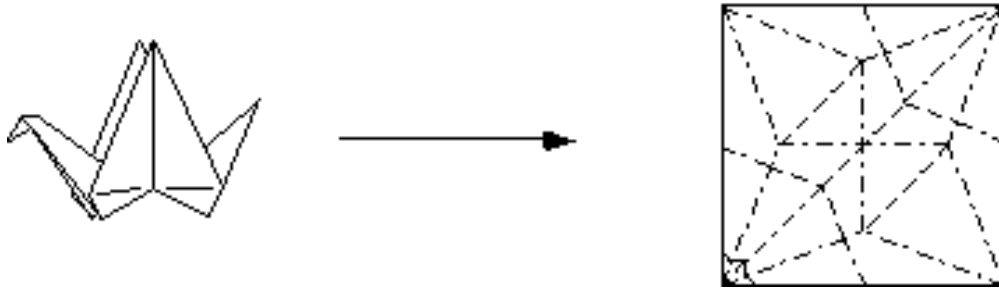

Figure 2.9: Crease pattern of a crane, (Leonardi, 1997, p. 2)

It is clear that, whether it is obtained by straight line folding or curved line folding, there are some geometry rules in these collections of creases. Such geometries, in other words mathematics of origami, have been studied extensively by origamists, mathematicians, and scientists. In this regard, the Italian-Japanese mathematician Humiaki Huzita has formulated a list of axioms, described in section 2.4.1, to define origami geometrically, Mathematician Toshikazu Kawasaki has a number of origami theorems, and scientist Robert Lang has developed an ingenious way to algorithmate the origami design process.

### **Shape, form and structure**

Shape and form are inseparable. Form has volume and mass in addition to shape. A three-dimensional form can have multiple two-dimensional shapes when rendered on a flat surface. This means that shape is only one aspect of form, whereas the form is the total visual appearance of a design. “Smaller forms which are repeated, with or without variations, to produce a larger form are referred to as unit forms” (Wong, 1993, p. 51). An origami form consists of a number of unit forms, which have identical or similar shapes and appear more than once in the design. The presence of unit forms helps to unify the design. Whether has single piece construction or modular construction, the copies of these relatively simple elements are repeatedly attached to one another in order to construct a complex origami form.

Structure literally means arranging or putting together to form a cohesive and meaningful whole. In a design, structure governs the way a form is built, or the way a number of forms are put together by imposing order and predetermining internal relationship of forms. In other words, structure is overall spatial organization and it is also shows functional relationships between parts of a whole (Wong, 1993, p. 246).

An origami form has a formal or semi-formal structure. Formal and semi-formal structures consist of structural lines that are constructed in a mathematical manner. By means of these structural lines, space is divided into a number of subdivisions equally or rhythmically, and forms are organized with a strong sense of regularity. However, slight irregularity exists in semi formal structure, although this structure is quite regular.

When unit forms are positioned regularly, with an equal amount of space surrounding each of them, it is said that they are in a 'repetitive structure'. A repetitive structure is formal, so the entire area of the design is divided into structural subdivisions of exactly the same shape and size, without spatial gaps between them. The basic grid, which is used in repetition structures, consists of equally spaced vertical and horizontal line crossing over each other. The basic grid provides same amount of space to each unit forms in above, below, left, and right. If the structure consists of more than one kind of structural subdivisions, which repeat both in shape and size, it is a 'multiple repetition structure'. A multiple repetition structure is still a formal structure. The various kinds of structural subdivisions are woven together in a regular pattern. Semi-regular plane tessellations, discussed in section 2.4.4, are examples of multiple repetition structure (Wong, 1993, pp. 61-63).

### **2.3 Principles of Origami Design**

The principles of design are the tools, which is used to format the elements of design. Formal or semi-formal origami forms are constituted by considering the principles such as repetition, gradation, and radiation, which are obtained through the rules of symmetry and isometry.

**Repetition** is the using of the same form more than once in a design. Repetition of unit forms usually conveys the sense of harmony. If the unit forms are used in larger size and smaller numbers, the design may appear simple and bold; when they are infinitely small and in countless numbers, the design may appear to be a piece of uniform texture, composed of tiny elements. In other words, the elements of design are blended into a harmonious whole by employing repetition (Wong, 1993, p. 51).

**Gradation** means transformation or change in a gradual, orderly manner. The sequential arrangement must be strictly considered; otherwise the order of gradation cannot be recognized. Gradation refers to gradual variation of the unit form, and it can be used in three different ways such as gradation of size but repetition of shape,

gradation of shape but repetition of size, and gradation of both shape and size (Wong, 1993, p. 247).

**Radiation** is the arrangement of the unit forms in regular rotation or concentric dilation. If the repeated unit forms or structural subdivisions are revolved around a common center, radiation is a special case of repetition. If the repetitions of unit forms or structural subdivisions around a common center go through a gradation of direction, radiation is described as a special case of gradation. The radiation patterns, for instance the wrapping fold patterns (see Figure 2.21) generate optical energy and movement from or towards the center (Wong, 1993, p. 87).

**Symmetry** is the relations between part and part, and between part and whole. It is the set of mathematical rules that describe the shape of a form. The two most common kinds of symmetry are reflection symmetry, also known as mirror symmetry, and rotational symmetry.

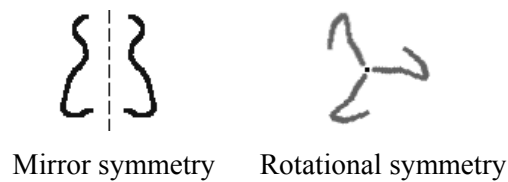

Figure 2.10: Two most common kinds of symmetry, (<http://www.weba.uwgb.edu>)

Parts of an object are related by rotational symmetry. As a general rule, an object is rotated through a certain angle and it will still have the same appearance. In the figures shown in Figure 2.11.a, the parts are related by a rotation around the center by 180 degrees. It looks the same twice in a 360-degree rotation, so it has two-fold symmetry, whereas Figure 2.11.b looks the same three times during a 360-degree rotation and is said to have three-fold symmetry. Also Figure 2.11.c has four-fold symmetry, and Figure 2.11.d has six-fold symmetry. In these regards, it is said that an object have n-fold symmetry if it looks the same after being rotated  $360/n$  degrees.

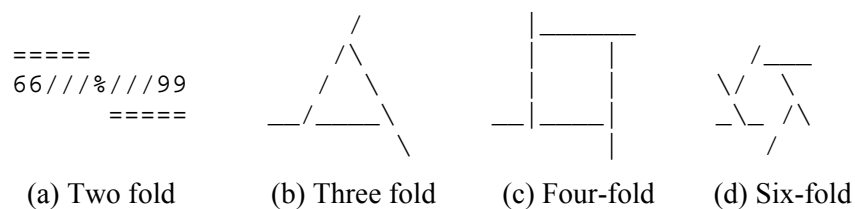

Figure 2.11: Samples of Rotational Symmetries, (<http://www.weba.uwgb.edu>)

Forms can have more than one kind of symmetry. For instance, to constitute the pattern shown in Figure 2.12.b, which based on  $p3$  tiling with 120 degree rotations, firstly, the three-fold rotational symmetry are applied to the Figure 2.12.a, and then Figure 2.12.c and Figure 2.12.d are obtained by applying mirror symmetry, which is represented by the letter ‘m’. In this regard, it is said that the pattern in Figure 2.12.c has  $p31m$  symmetries.

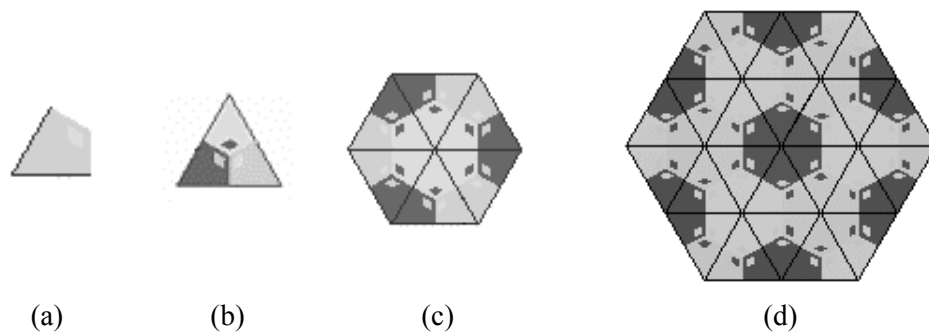

Figure 2.12: The pattern constituted by rotational symmetries and reflection symmetries  
(<http://www.mathforum.org>)

**Isometry** is a geometrical operation that preserves all distances, including translation, rotation and reflection. There are four distinct kinds of symmetry, corresponding to four basic ways of moving a tile around in the plane. In mathematical language, these different ways of moving things in the plane are called as ‘isometries’ (see Figure 2.13).

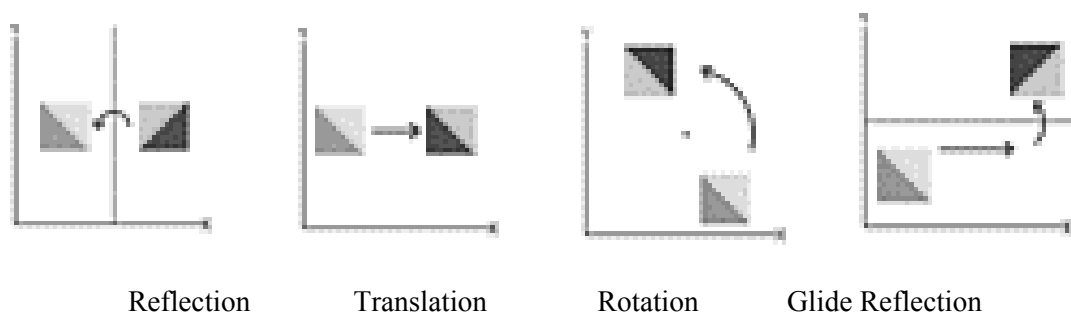

Figure 2.13: Isometries, (<http://www.mathforum.org>)

Reflection, the basic operation of folding paper into a flat state, is obtained by flipping. Translation, a combination of two successive reflections across parallel lines, is obtained by sliding. Rotation, a combination of two successive reflections across intersecting lines, is obtained by turning. Glide Reflection is obtained by flipping besides sliding (Dutch, 1999).

The patterns of origami forms, which are constituted by considering symmetry and isometry principles, are labeled with the name used by the International Union of Crystallography since 1952. There are exactly seventeen of them (See Figure 2.14).

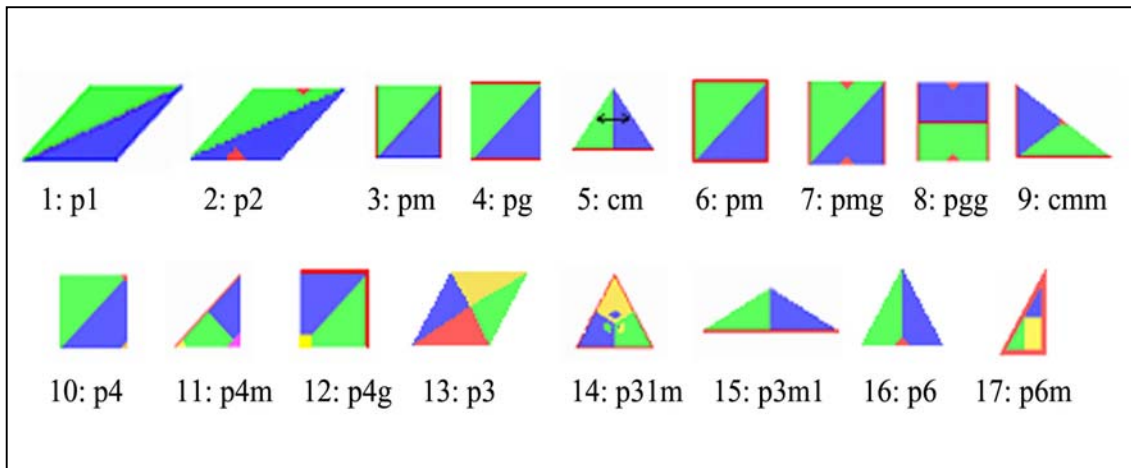

Figure 2.14: Seventeen symmetry groups, (<http://www.mathforum.org>)

## 2.4 Basics Of Origami Design

The basic technique of origami is folding. Standard types of folds are used to form ‘bases’, or starting shapes. When a base folded along a line and then unfolded, a ‘crease pattern’ is obtained. A finished origami form is called a ‘model’; drawn instructions for a model are called a set of ‘diagrams’.

### 2.4.1 Folding and Unfolding

Fold literally means to bend over so that one part overlaps another part, moving from an extended to a closed position. A line, pleat, or crease formed by folding. The basic technique of origami is folding. It is the result of, or the process of, introducing a bend into the previously flat plane of the paper. The simplest fold is the ‘valley fold’, where a flat piece of paper is folded towards the folder. When this fold is unfolded, the crease line forms a valley shape. Closely related is the ‘mountain fold’, where the paper is folded away from the folder. This crease line forms a mountain shape. Certain combinations of basic folds showed in Figure 2.15 form bases that are used to fold many different models.



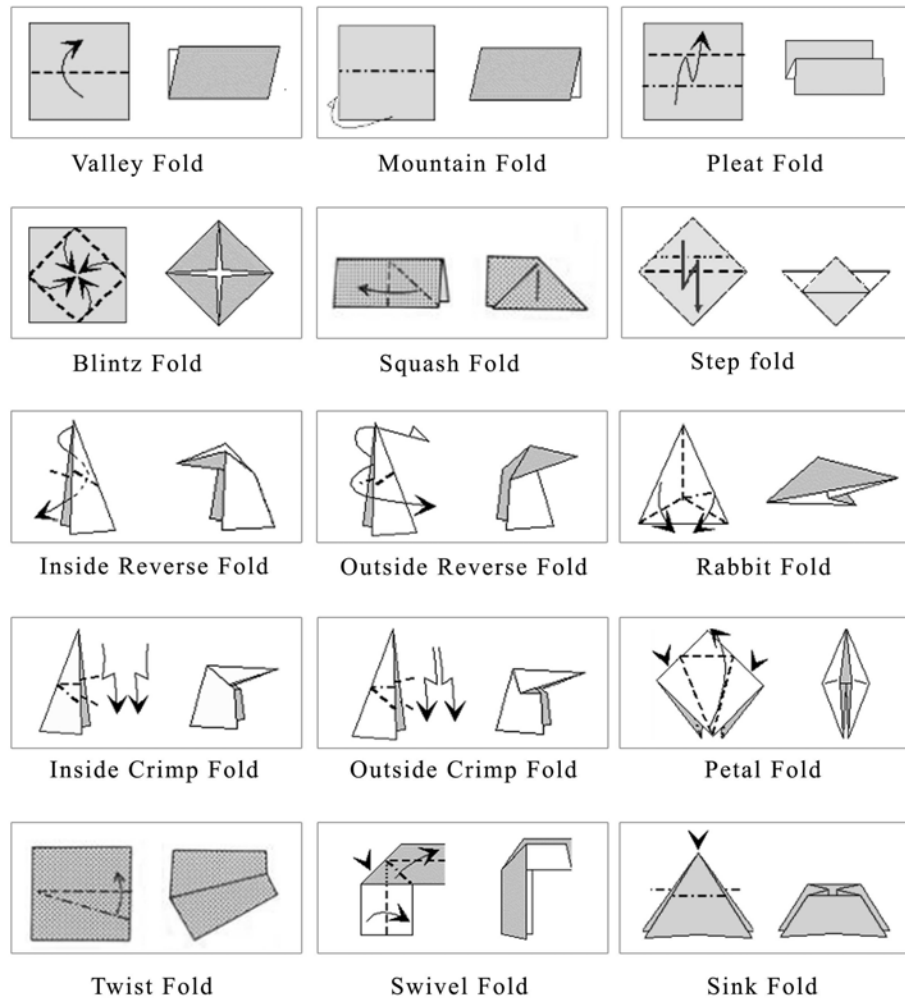

Figure 2.15: Basic folds, (Kenneway, 1997, pp. 8-10)

### Huzita's Origami axioms on folding

The Italian-Japanese mathematician Humiaki Huzita has formulated a set of origami axioms what is currently the most powerful known. It is described in below.

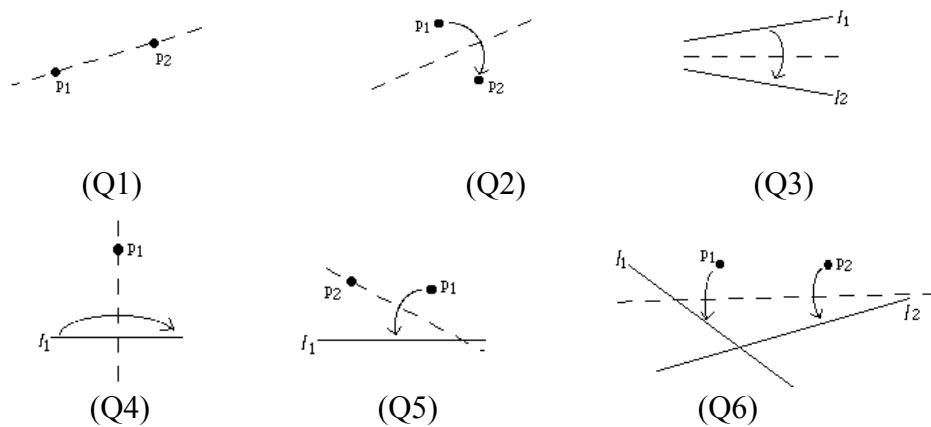

Figure 2.16: Huzita's Six Origami Axioms, (Takahashi, 2002, p. 4)

- (O1) Given two points  $\mathbf{p}_1$  and  $\mathbf{p}_2$  we can fold a line connecting them.
- (O2) Given two points  $\mathbf{p}_1$  and  $\mathbf{p}_2$  we can fold  $\mathbf{p}_1$  onto  $\mathbf{p}_2$ .
- (O3) Given two lines  $\mathbf{l}_1$  and  $\mathbf{l}_2$  we can fold line  $\mathbf{l}_1$  onto  $\mathbf{l}_2$ .
- (O4) Given a point  $\mathbf{p}_1$  and a line  $\mathbf{l}_1$  we can make a fold perpendicular to  $\mathbf{l}_1$  passing through the point  $\mathbf{p}_1$ .
- (O5) Given two points  $\mathbf{p}_1$  and  $\mathbf{p}_2$  and a line  $\mathbf{l}_1$  we can make a fold that places  $\mathbf{p}_1$  onto  $\mathbf{l}_1$  and passes through the point  $\mathbf{p}_2$ .
- (O6) Given two points  $\mathbf{p}_1$  and  $\mathbf{p}_2$  and two lines  $\mathbf{l}_1$  and  $\mathbf{l}_2$  we can make a fold that places  $\mathbf{p}_1$  onto line  $\mathbf{l}_1$  and places  $\mathbf{p}_2$  onto line  $\mathbf{l}_2$ .

From algorithmic point of view, these axioms imply two operations; finding a line and folding the origami along the line (Takahashi, 2002, p. 4).

### 2.4.1.1 Folding Geometries

Folding geometries are of three quite distinct kinds; natural, embedded and non-located. In the first two kinds of folding geometry, the folds and/or creases are positioned by using of location points. In the third kind of position, the folds and/or creases are positioned by eye (though their positions may subsequently be refined by an iterative process).

**The natural folding geometry** of a paper-shape is the folding geometry obtained by using just the primary reference points (the original edges and corners of the paper-shape) to determine where the creases will form. Various rectangles used as starting shapes in modular origami and their folding geometries are briefly discussed in below.

In the case of the square the natural folding geometry consists of two creases obtained by folding opposite edges onto each other and two creases obtained by folding opposite corners onto each other. The first set divides the square into four smaller squares. The second set bisects these smaller squares at 45 degrees. This system of natural folding geometry can be called the 90/45-degree system. The resulting crease pattern is familiar as the crease pattern of the water bomb base and preliminary fold (Figure 2.17.a). The natural folding geometry creates secondary reference points, which can be used to locate further creases, such as those required for the bird base (Figure 2.17.b).

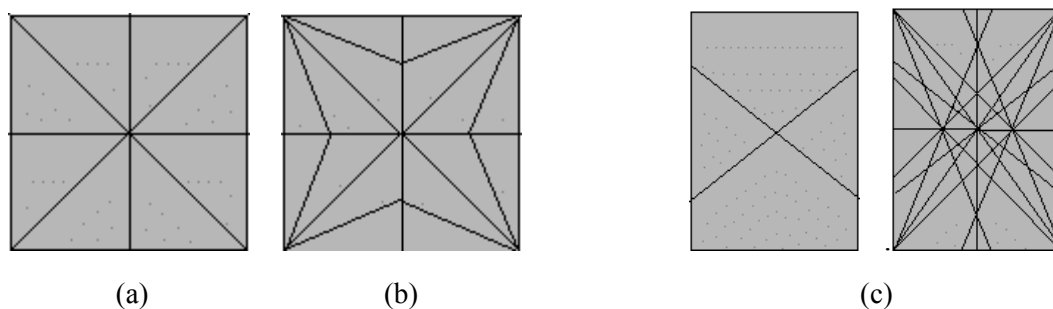

Figure 2.17: Natural folding geometries of square and rectangle  
<http://www.mizushobai.freemove.co.uk/natural.htm>

The natural folding geometry of rectangles is more complex than the square. The natural folding geometry of a rectangle is determined by an angle at which the creases formed by folding opposite corners together cross, or an angle at which the diagonals cross - which is always the same (Figure 2.17.c).

The Silver Rectangle has sides in the proportion of  $1:\sqrt{2}$ . The natural folding geometry of the silver rectangle yields angles of 110/70/55 degrees. These angles are found in the structure of the tetrahedron, the cube and the cuboctahedron as well as in the many interesting forms known as rhombic polyhedra.

The Bronze Rectangle has sides in the proportion of  $1:\sqrt{3}$  and its natural folding geometry yields angles of 120/60/30 degrees. The bronze rectangle is its own triple.

The Leftover Rectangle is the rectangle left over when the largest possible square is removed from a silver rectangle. The leftover rectangle has sides in the proportion of  $1:1+\sqrt{2}$  and naturally yields angles of 135/67.5/45 degrees.

The Platinum Rectangles naturally yield the 108/72/36-degree angles required for modeling polygons and polyhedra related to the regular pentagon. The platinum rectangles are little used in modular origami design, since it is easy to generate a similar folding geometry from the  $3 \times 1$  rectangle and the square.

The Golden Rectangle has sides in the golden proportion of  $1:1.618$ . There are only a few modular origami designs, which make use of the natural folding geometry of this rectangle.

**Embedded folding geometry** is natural to one particular paper-shape can also be embedded (by means of a careful choice of secondary reference points) within a shape to which it is not natural. The most common use of a non-located folding geometry is that of dividing an edge or a crease into three roughly equal parts by means

of a first guesstimate refined by an iterative process. In the structures designed by David Huffman shown in Figure 2.18, two or more of these distinct types of folding geometry are combined within a single design.

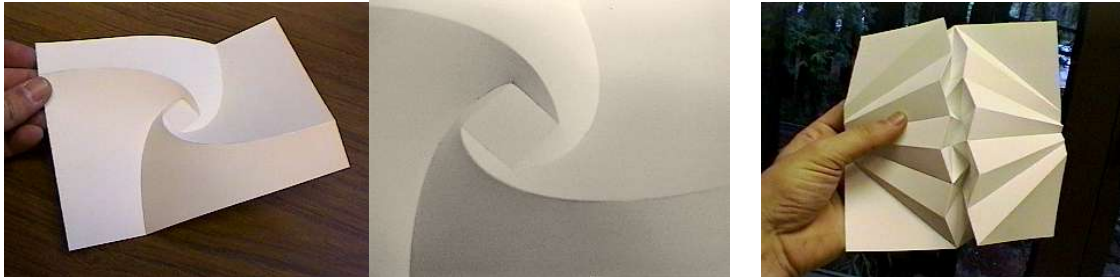

(a) 4 parabolic curved folds that meet in a central square

(b) Straight folds

Figure 2.18: Geometrically folded structures, (<http://www.sgi.com/grafica/huffman/index.html>)

### 2.4.1.2 Flat Foldability

Flat folding' means folding ' $n$ ' dimensional origami form into the plane, and so the paper must necessarily touch itself. In the case of a flat folding, the flat folded state is called as flat origami. ' $k$ ' represents the dimension of medium and ' $n$ ' represents the dimension of an origami form, if so  $k = n$  represents the folded or unfolded state of a flat origami; whereas  $k < n$  represents folded state of polyhedra and  $k = n$  represents unfolded or flattened state of polyhedra (Demaine, 2001, p. 20). The folded state of the form shown in Figure 2.19 is represented as  $k < n$ . However this form is not flat foldable.

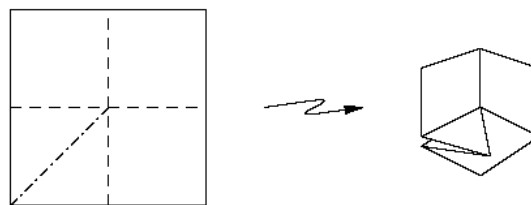

Figure 2.19: Sample of non-flat foldable form, (Bender & Demaine, 2003, p. 5)

### Kawasaki's theorem on flat foldability

A crease pattern is called as 'flat foldable' if there is a mountain-valley assignment so that each vertex locally folds flat. For crease patterns with a single

vertex, it is relatively easy to characterize flat foldability. Without specified crease directions, a single-vertex crease pattern is flat-foldable precisely if the alternate angles around the vertex sum to  $180^\circ$ . Mathematical formulization and graphical representation of Kawasaki's theorem are shown in Figure 2.20 (Demaine, 2001, p. 26).

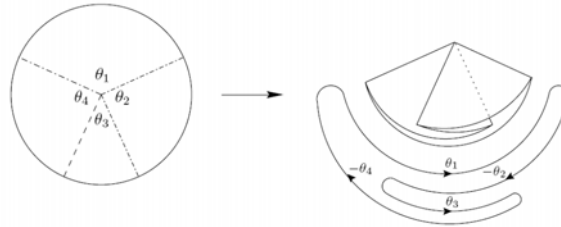

Figure 2.20: A flat-foldable vertex:  $\theta_1 + \theta_3 + \dots = \theta_2 + \theta_4 + \dots = 180^\circ$ , (Demaine, 2001, p. 26)

### 2.4.1.3 Miura Ori Flat Folding Technique

'Miura Ori Technique', which was developed by a Japanese scientist Kouryou Miura in 1980, is made up of a series of folds that follow a grid where the vertical lines are diagonal or zigzag. The horizontal folds are straight with an alternating valley and mountain fold given by the zigzag, that is, the vertical lines that come in zigzag fold as mountain or valley all the way across. Using the same system in a straight fold grid, the transmission of the movement is irregular and jams the system. The zigzag lines make the intersections displace one another thus avoiding friction and stress between them, which makes it more resistant at those points. When Miura Ori is applied on other materials such as metals, it allows the use of hinges that do not have friction among them, and then the material stress is also avoided. If Miura Ori Technique is applied to a map (see Figure 2.21), it allows instant opening by just pulling apart two corners and collapsing the map back equally fast and easy (Bain, 1980, p. 1).

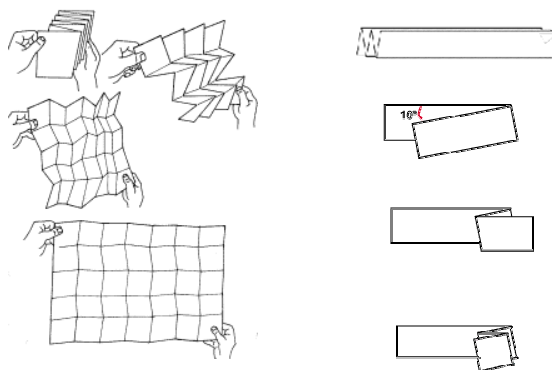

Figure 2.21: Miura Ori Map Folding, (Bain, 1980, p. 1)

#### 2.4.1.4 Wrapping Fold

Wrapping fold is considered as different way of packaging a flat and thin medium. Instead of folding it flat, it is wrapped around a central circular hub as shown in Figure 2.22. It can be seen that the folding pattern consists of a symmetric set of mountain and valley folds.

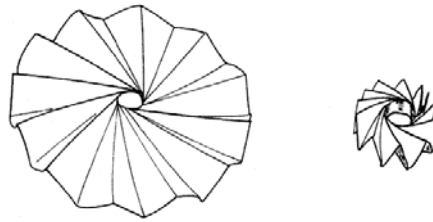

Figure 2.22: Wrapping Fold around a central hub, (Pellegrino & Vincent, 1998, p. 12)

This packaging scheme was firstly invented by Huso in 1960 for folding compactly the tarpaulin top cover of a car, then, in 1989, this folding pattern was proposed for the packaging of a solar sail by Temple and Oswald. Then, In 1992, a similar pattern with  $n$  straight mountain and  $n$  straight valley folds, which are wrapped around a prismatic hub with  $2n$  sides, developed by Guest and Pellegrino. An example of this wrapping fold pattern shown Figure 2.23 is almost fully deployed, and almost fully folded (Pellegrino, 1998, p. 12).

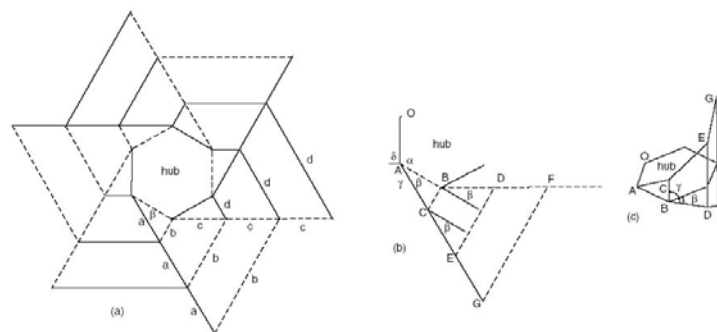

Figure 2.23: Wrapping Fold around a central prismatic hub, (Pellegrino & Vincent, 1998, p. 14)

#### 2.4.1.5 Unfolding and Flattening Polyhedra

A classic open problem is whether the surface of every convex polyhedron can be cut along some of its edges and unfolded into one flat piece without overlap. Such

edge unfolding has important practical applications in the field of packaging and sheet metal bending.

A standard method for building a model of a polyhedron is to cut out a flat unfolding, then, fold it up, and glue the edges together so as to make precisely the desired surface. Given the polyhedron of interest, a natural problem is to find a suitable unfolding. In manufacturing applications, it is considered that keeps the faces rigid and avoids crossings in a folding process of a polygon into a polyhedron, or a continuous unfolding of a polyhedron into a polygon (Demaine, 2001, pp. 29-35).

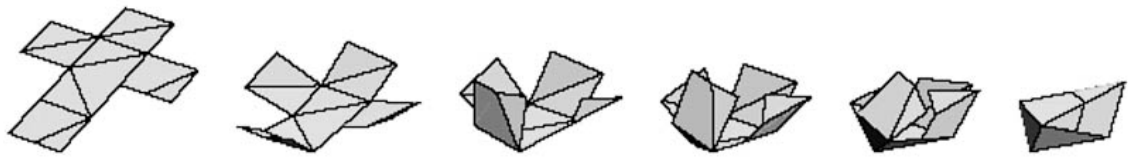

Figure 2.24: Unfolding of an octahedron, (Demaine, 2001, p. 35)

The flattening problem is flatten the polyhedral complex into a flat folded state without cutting or stretching the paper. Intuitively, flattening can be achieved by applying force to the polyhedral model, but in practice this can easily lead to tearing the medium. Instead of applying force, it should better to treat a polyhedral surface as a piece of paper and fold it as in flat origami (Demaine, 2001, p. 36).

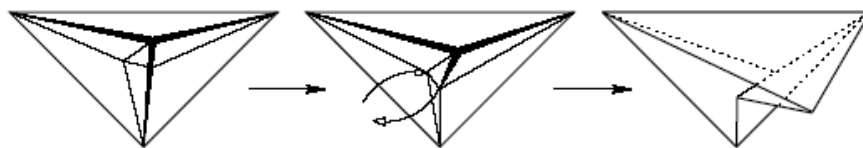

Figure 2.25: Flattening a tetrahedron, from left to right, (Demaine, 2001, p. 36)

## 2.4.2 Base

Standard types of folds are used to form bases, or starting shapes. A base is simply a geometric shape that resembles the subject to be folded. The four most common bases, from simplest to the more complex, are the ‘kite base’, the ‘fish base’, the ‘bird base’ and the ‘frog base’.

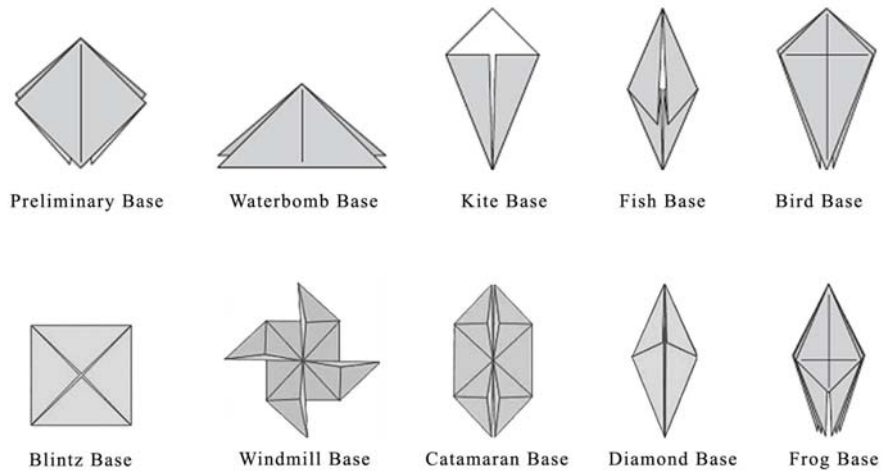

Figure 2.26: Flat foldable Origami bases, (Lang, 2000, pp. 28-29)

There are also another sets of polyhedral bases for designing modular forms. A polyhedron is a three-dimensional figure made up of sides called faces, each face being polygon. A polygon, in turn, is a two-dimensional figure made up of line segments, called edges, that are connected two at a time at their endpoints. In a polyhedron, several polygonal faces meet a corner (vertex). When all the edges of the polygon are of equal length the polygon is called regular. These polyhedras are also called regular polyhedra because they are made up of faces that are all the same regular polygon. The five platonic polyhedras shown in Figure2.27.a are the tetrahedron, the cube, the octahedron, the dodecahedron and the icosahedrons Tetrahedron, the four-faced pyramid that is structured minimally, is the strongest of these solids, because of its being most able to resist external forces from all directions (Gurkewiz, 1995, p. 4).

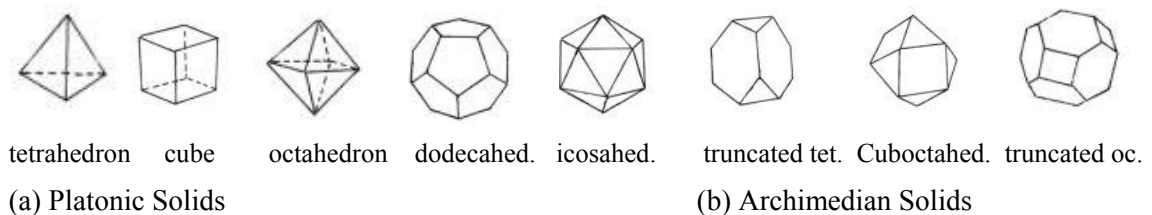

Figure 2.27: Polyhedral bases of modular origami, (Gurkewiz & Arnstein, 1995, p. 5)



Other sets of solids can be obtained from the Platonic Solids, which are so-called Archimedean Solids (Figure 2.27.b). They are semi-regular polyhedra; in such a way that all faces are regular polygons, but there is more than one polygon in a particular solid, and all vertices are identical.

Star polyhedras are another set of solids derived from platonic solids by extending the faces of each to form a star (Figure 2.27.c).

### 2.4.3 Crease Pattern

When a base folded and then unfolded, a crease pattern is obtained. Crease patterns represented by two systems of lines that represent hills and valleys in the 3 dimensional configurations. These lines are usually indicated on paper with two different line-styles, in such a way that a dashed line indicates a valley fold -a concave crease, whereas a line of dots and dashes indicates a mountain fold-a convex crease (see Figure 2.28). When these two systems of lines intersect, they form self-similar surface elements, to be called here tiles. The shape of the tiles that occur in this manner is polygonal with or without side regularity. A crease pattern displays several types of symmetric organizations (Liapi, 2002, p. 387).

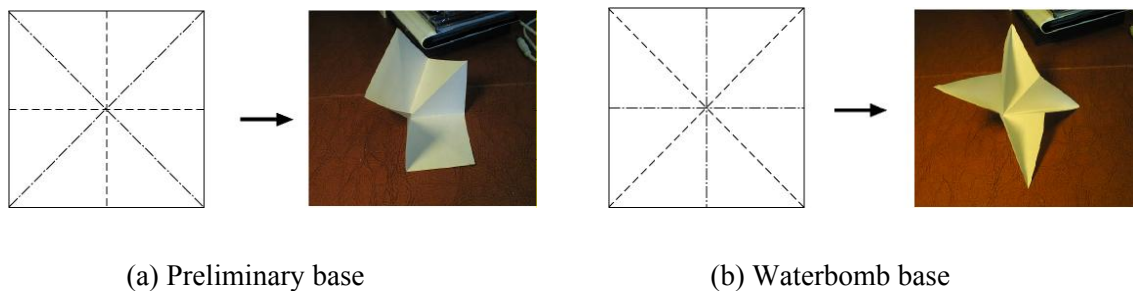

Figure 2.28: Crease pattern, (<http://www.mizushobai.freeseerve.co.uk/technicalmanual.htm>)

### 2.4.4 Origami Tessellations

Literally, ‘tessellate’ means to form or arrange small squares in a mosaic pattern. The word ‘tessellate’ is derived from Greek word ‘tesseres’, which in English means ‘four’. Since a mosaic extends over a given area without leaving any region uncovered, the geometric meaning of the verb tessellate is to cover the plane with a geometric pattern that has regular shapes or polygon in such a way as to leave no spaces between the meeting-points of their vertices. (Critchlow, 1969, p. 60)

An origami tessellation is a tiling, which consists of the repeated use of similar geometric shapes that completely fill a plane without any gaps or overlaps. For instance, the repetitive geometrical pattern of flat folds shown in Figure 2.29 is created by pre-creasing, and twist folding of a single sheet of paper (Schwartzman, 1994).

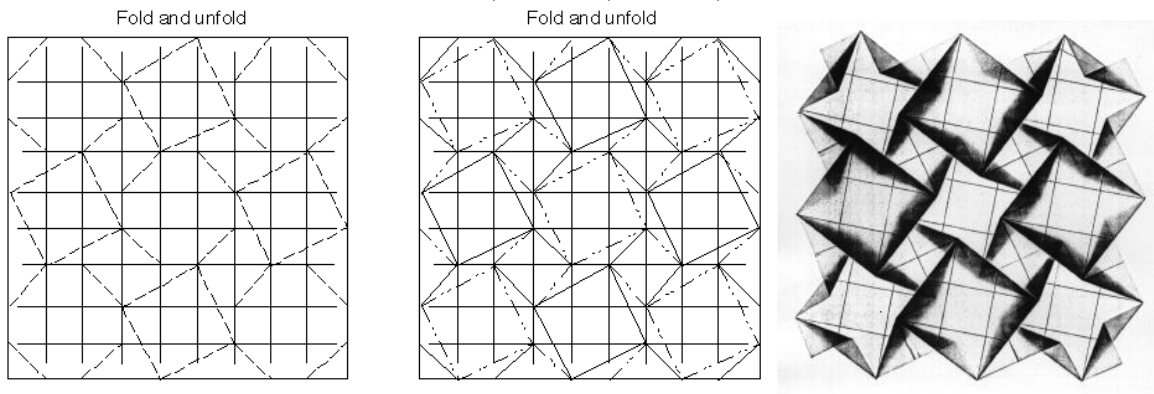

Figure 2.29: Pre-creasing and twist folding, (Demaine, 2001, p. 25)

Tessellations are divided into three distinct groups such as regular, semi-regular and demi-regular. A regular tessellation made up of congruent regular polygons. ‘Regular’ means that the sides of the polygons are all the same length, and ‘congruent’ means that the polygons are all the same size and shape. Both semi-regular and demi-regular tessellations consist of two or more variety of regular polygons. But, whereas tiling with semi-regular tessellation are extended infinitely, tiling with semi-regular tessellation are not.

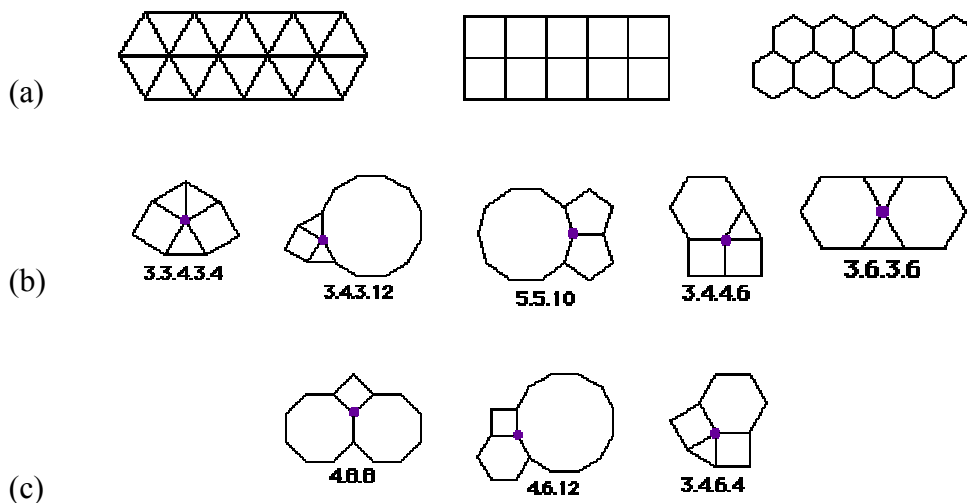
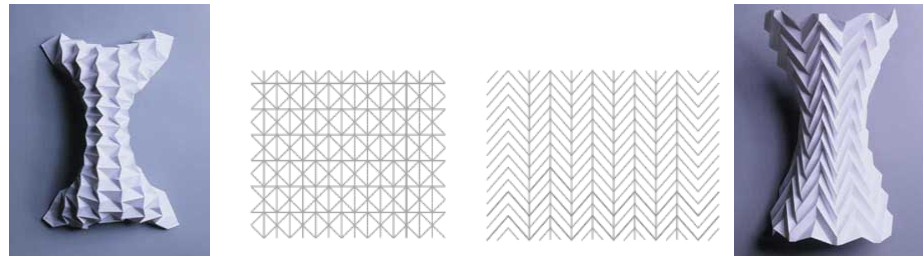
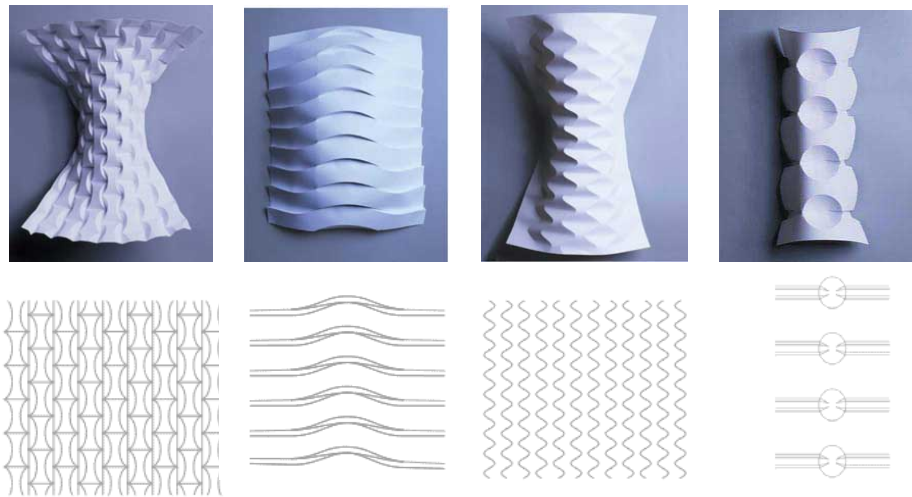

Figure 2.30: Tessellation groups: (a) Regular, (b) Semi-Regular, (c) Demi-regular, (Critchlow, 1969, p. 65)

As a rule of thumb, a tessellation is named in respect of how many polygons surrounding a vertex, and how many sides has each polygon by considering the clockwise and beginning with the polygon that has the fewest side (Critchlow, 1969, p. 65).



(a) Regular tessellations with straight line



(b) Non-regular Tessellations with curved line

Figure 2.31: Tessellations designed by Enlai Hooi, (<http://www.enlaihooi.com/images/jpges>)

There is also a recent trend results from the studies on curved line folding in computational origami: Creating pattern that has curved line or both curved and straight line. The samples shown in Figure 2.31.b are organic and inherently structural origami surfaces design by Enlai Hooi in 2000.

## 2.5 Classification of Origamic Structure

In the scope of this thesis, origamic structures are mainly categorized according to number of sheets used. In other words, origami structures are divided into two distinct categories, in such a way that, single sheet structures that whose constructions are entirely made on a single piece of sheet, and modular structures that whose

constructions are made on two or more pieces of sheet. And also, single piece constructions are taken up as deployable planar structures, and then discussed in three lateral types such as pop-up structures, biomimetic folding patterns and deployable cylinders.

### **2.5.1 Deployable (Transformable) Planar Structures**

Transformable structures are defined as structures that are capable of executing large configuration changes in an autonomous manner. The configuration of such structures change between a compact-packaged state, and a large-deployed state (Pelegriano, 2001, p. 148).

Similar concepts of spatial transformation are encountered in the origami form, which has a planar paper surface in unfolded state, then transforms to a three-dimensional object by folding. Principles of the origami design and math can find applications in the conception and design of deployable (transformable) structures for architectural and industrial product. These structures are driven primarily by a fundamental concept of geometric change and they provide a new approach to a common packaging problem.

An observation of the kinematics of different origamic structures shows that at least two different methods for folding or unfolding origami structures are possible. In the first, the model unfolds in a sequential fashion, which the distinct steps must be followed each other, and each new step starts when the motion of the previous has been completed. In the second, the structure deploys synchronously. The latter means that all tiles move at the same time, and the motion of one affects the motion of all other tiles adjacent to it (Liapi, 2002, pp. 385-388).

In these contexts, in addition to the structures and patterns discussed below, wrap folding pattern, the Miura-Ori folding pattern, and origami tessellations, which were discussed beforehand in section 2.4.1 and 2.4.4, also constitute the synchronously deploying structures.

#### **2.5.1.1 Pop-Up Structures**

‘Pop-up structure’ is defined as a self-erecting, three-dimensional structure, formed by the action of opening a crease. This structure erects fully when two adjacent

base pages, on which it sits, are opened to a right angle. Paper folding and cutting is integrated with these structures to achieve pop-up effects. In such a way that a piece of sheet is first cut into a predetermined pattern. This separates the sheet into various sections and strips. These sections and strips are folded, and then, the whole sheet is folded to rise up the pop-ups and make the creation three-dimensional.

Collapsible pop-ups can be classified by the angle of opening two base pages, on which the pop-up structure sits, specifically at  $90^\circ$ ,  $180^\circ$  and  $360^\circ$ . These are the angles at which the pop-ups are fully erected. Some pop-ups are termed with  $0^\circ$ . In other words, there is no folding of base pages, but layers of cut papers overlapping on top of one another with some protruding portions.

Pop-up structures are forming by folding and cutting techniques that is similar to Kirigami, but becoming different in sequence. In Kirigami (see Figure 2.2 and Figure 2.6), the folding comes before the cutting. On the contrary, in pop-up structure folding comes after the cutting or slitting. Techniques with slitting are mainly for  $90^\circ$  one-piece type. These include the single slit (Figure 2.32.a) and double slits (Figure 2.32.b). Variations can be achieved by altering the length and shape of the slit lines.

A pop-up structure can be made up of different number of pop-up levels. A pop-up level is a layer of pop-up pieces built over the gutter crease or existing creases on other pop-up layers. For example, the structure in Figure 2.32.c is made up of two-level. The process of developing a pop-up level over a crease is termed as a crease initiation. There are two types of crease initiations for a pop-up level: a mountain crease or a valley crease. In Figure 2.32.c, the first pop-up level is developed by a mountain crease initiation, and the second level is developed by a valley crease initiation, whereas the both two pop-up levels in Figure 2.32.d developed by mountain crease initiations.

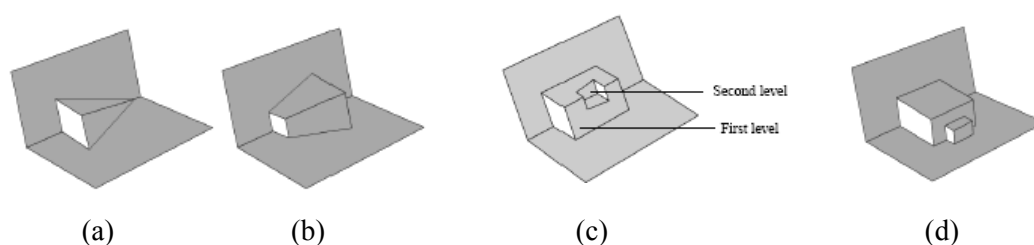

(a) A pop-up made from a single slit. (b) A pop-up constructed from double slits. (c) The first pop-up level is a mountain crease initiation and second level is a valley crease initiation. (d) A pop-up structure with double mountain crease initiation.

Figure 2.32: Pop-up structures, (Tor\* & Mak\* & Lee, 2003, p. 3)

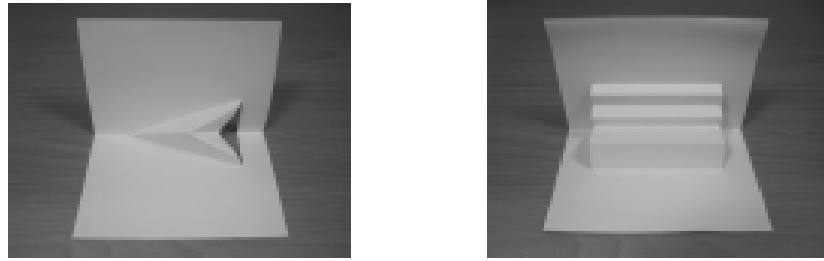

(a) Single slit pop-up with a vertex fold      (b) Double slit pop-up with pleats

Figure 2.33: Additional pop-up effects by folding, (Tor\* & Mak\* & Lee, 2003, p. 6)

After a basic pop-up structure has been developed, it is possible to further fold the planar pieces to create additional pop-up effects (Figure 2.33). However, there is a specific technique to fold the planar pieces, for other folding methods would hinder the structure from erecting properly. The feasible method is by changing the mountain-valley assignment of an existing crease on the pop-up structure and creating two new creases at the same time. In origami idiom, this folding method is known as ‘reverse folding’ (see Figure 2.15). Reverse folding on pop-up structures can produce flat vertex folds or pleats. A flat vertex fold has crease lines that meet at a vertex whereas those of pleats do not. Consequently, pop-up structures are flat foldable in un-erected state, and when erected they are deployable into three dimension synchronously (Tor\*, Mak\*, Lee, 2003, pp. 2-6).

### 2.5.1.2 Biomimetic Folding Patterns

The folds patterns of origami-type structure have presented in this section are ‘biomimetic’, in such a way they were developed by considering how the folding of a natural structure -a leaf. The leaves of most plants are folded or rolled while still inside the bud. The unfolding of a hornbeam leaf with a straight central primary vein and symmetrically arranged parallel lateral secondary veins, generate a corrugated surface (Figure 2.34). This simple and regular corrugated folding patterns and mechanisms can suggest ideas for the design of polygonal foldable and deployable structures such as solar panels and lightweight antennae of satellites, or for the folding of deployable membranes such as tents, clothes or other coverings. Leaves of hornbeam could be modeled as plane surfaces, with straight parallel folds. The lateral veins, when the leaves are outstretched, are angled at 30-50° from the center vein. A higher angle allows

the leaf to be folded more compactly within the bud, but it takes longer to expand. This may allow the plant to optimize the timing of leaf deployment with ecological and physiological conditions.



(a) A bud folded (b) early stages of unfolding (d) corrugated leaves

Figure 2.34: Unfolding manner of hornbeam leaves, (Kobayashi & Kresling, 1998, p. 148)

The paper model with mountain and valley creases shown in Figure 2.35 simulates the unfolding of a regularly corrugated simple leaf. This pattern is a simple form of Miura-Ori, and allows simultaneous extension in two directions perpendicular to each other, like Miura-Ori does (Kobayashi & Kresling, 1998, pp. 147-150).



Figure 2.35: Stages in making leaf folding 'ha-ori', (Kobayashi & Kresling, 1998, p. 150)

The one-leaf unit pattern shown in Figure 2.36, which is a folding structure deploys synchronously, consists of a corrugated surface of alternating mountain and valley folds, meeting the midrib at an angle  $\alpha$ .

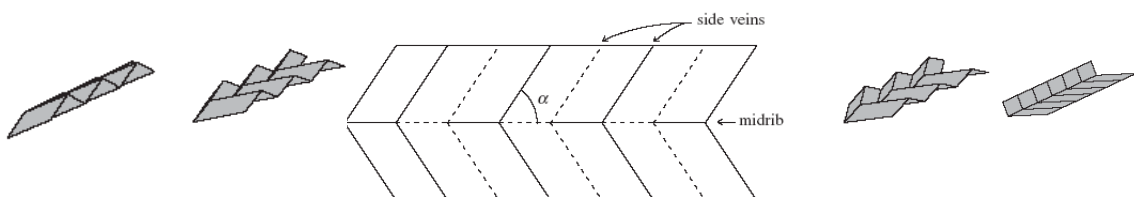

Figure 2.36: Leaf-folding structure extends simultaneously in two directions, (Guest & Focatiis, 2002, p. 3)

The leaves units can be arranged in two basic ways, either pointing towards the center of the polygon, the so-called ‘leaf-in’ (Figure 2.37.b), or directed away from it, the so-called ‘leaf-out’ (Figure 2.37.a). By changing the angle  $\alpha$  of the fold lines on the leaf-in pattern while retaining the same number of leaves, another pattern known as the ‘skew leaf-in’ (Figure 2.37.c) is obtained.

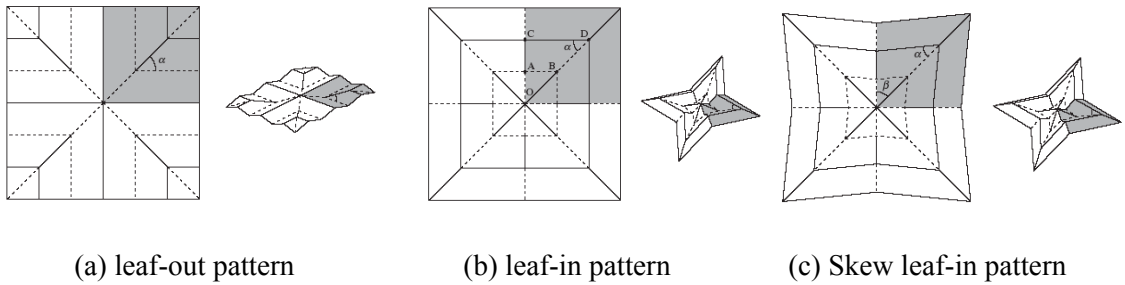

Figure 2.37: Leaf patterns. One leaf is shown shaded, (Guest & Focatiis, 2002, p. 5)

Both two patterns leaf-in and leaf-out are unfolded in a sequential fashion. However the skew leaf-in pattern deploys synchronously. Deployments of these distinct three leaf patterns are shown below in Figure 2.38.

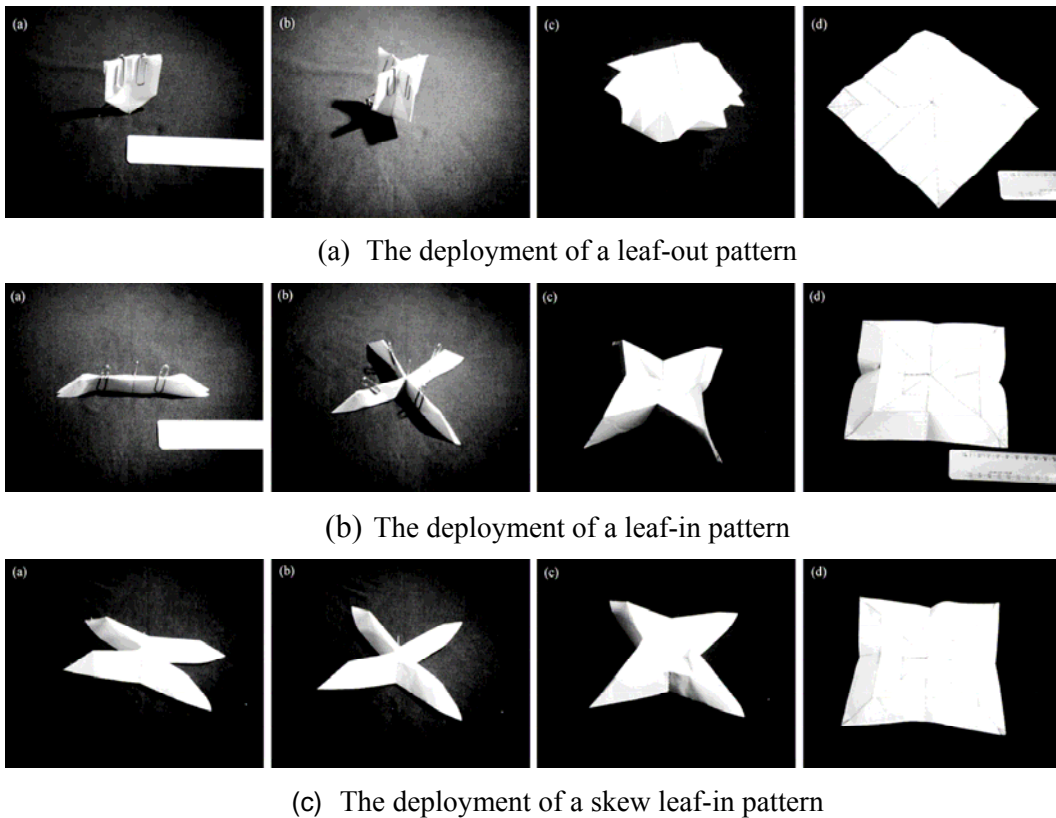

Figure 2.38: The deployment of leaf patterns paper model in four stages, (Guest & Focatiis, 2002, p. 6)



The deployment of the skew leaf-in pattern is smoother than the leaf-in pattern for equivalent parameters. One of the main differences between these patterns is that skew leaf-in structure is unable to fold fully closed, whereas leaf-out and leaf-in structure is able. Another difference is that the deployment of the skew leaf-in structure occurs in a single smooth movement, however leaf-in and leaf-out structure requires an additional deployment hurdle because of they needs to snap through the final folded stage (Guest & Focatiis, 2002, pp. 2-6).

### 2.5.1.3 Deployable Cylinders

Deployable Cylinders, carried out by Guest & Pellegrino in 1994, is a system of folds based on the wrinkles that occur when compressed objects like cans, paper, etc. are crushed. There is a folding module, which has the characteristic of bending back completely, in the pattern of the crushed object. This pattern consists of identical triangular planes, which keep on being identical also while deploying. These identical triangular planes are ordered along a helical strip to constitute the cylinder (Figure 2.39.a). The synchronously deploying phases of cylinder is shown in Figure 2.39.c. The illustration in the left shows deployed (unfolded) state, in the middle it is shown while folding, and the folded state is shown in the right. (Pelegrino 2001, pp.144-149)

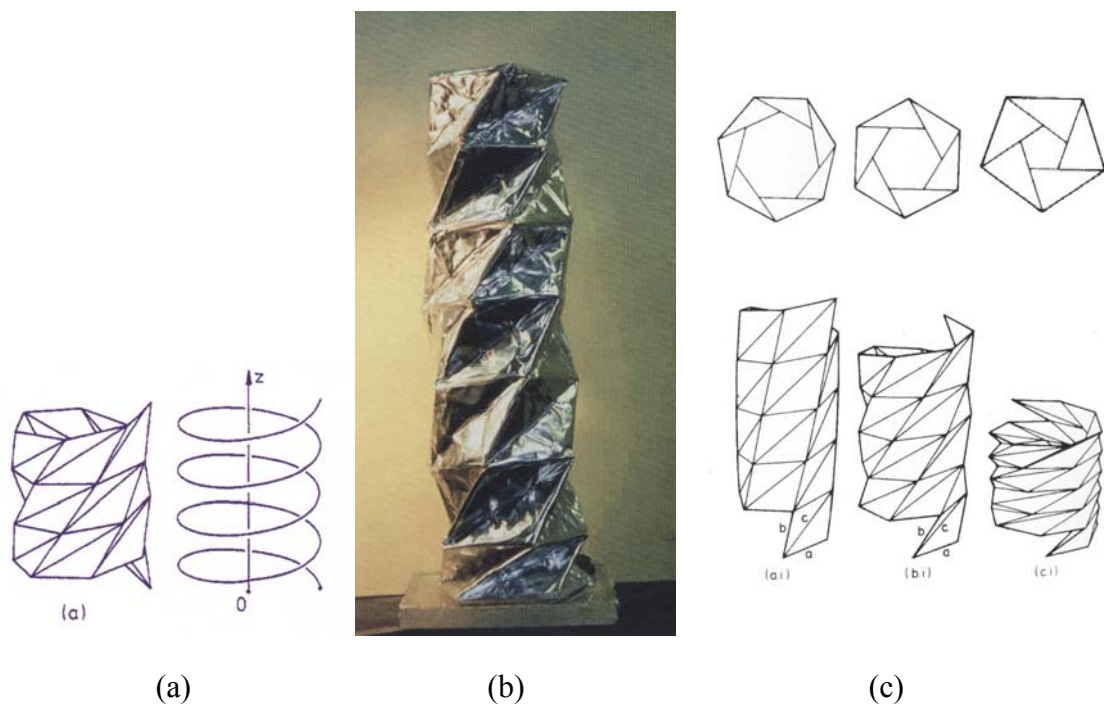

Figure 2.39: Deployment of a cylinder, (Pelegrino, 2001, p. 148)

## 2.5.2 Modular Structures

In origami, the word ‘module’ implies the units that are repeatedly attached in order to construct complex forms. These units has simple structure, which are either all identical or occur in sets of different complementary units.

‘Modular structures’ are obtained by a two stage folding technique of multiple pieces of sheets. In the first stage each piece of sheet is folded into a module, and secondly the modules are assembled into an integrated flat shape or three-dimensional structure. While the one set of modules form the visible surface, another set are used to link them together. In most cases the design of the modules integrates the two or more elements into a seamless whole.

**Modular pattern** is flat folded modular structures. Modular patterns divide the visible surface of the form into visually distinct regions. In order to understand modular patterns it is necessary to consider the distinction between plain and contrast modules.

A plain module is a module whose visible surface is homogeneous; on the contrary a contrast module’s visible surface is differentiated. Differentiation of the surface of a module is achieved by using two sides colored medium, and forming the visible surface of the module by using both surfaces of the medium.

Three different kinds of modular pattern are ‘multi-color pattern’, ‘contrast pattern’, ‘multi-color contrast pattern’. Multi-color patterns are patterns formed by combining plain modules, which is folded from two sides colored medium. Contrast patterns are patterns formed by combining contrast modules, each of which is folded from an identical one side colored medium. Multi-color contrast patterns are formed by combining contrast modules that folded from one side colored mediums in two distinct colors.

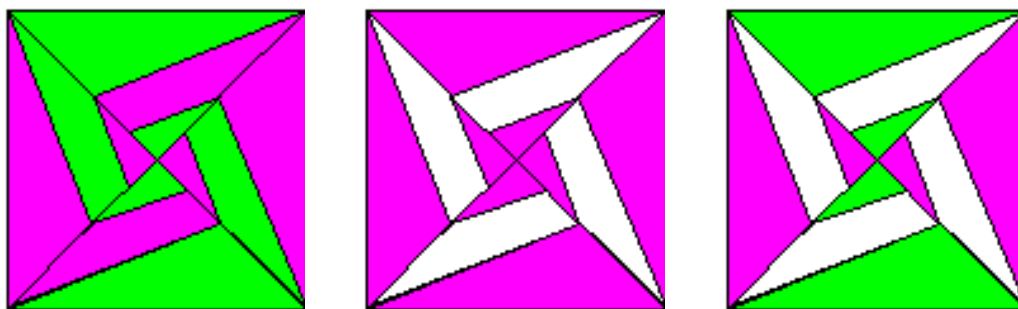

(a) Multi-color

(b) Contrast

(c) Multi-color contrast

Figure 2.40: Modular patterns, (<http://www.mizushobai.freemove.co.uk/technicalmanual.htm>)

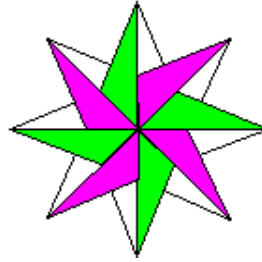

Figure 2.41: Two Fold Star, (<http://www.mizushobai.freemove.co.uk/technicalmanual.htm>)

Two Fold Star shown in Figure 2.41 designed by David Mitchell, is another example of multi-color contrast pattern made by combining eight modules that each one is produced from a silver triangle using only two folds. Modular structures shown in Figure 2.42 have infinitely extensible origamic surfaces, which are capable of being extended without limit in all directions.

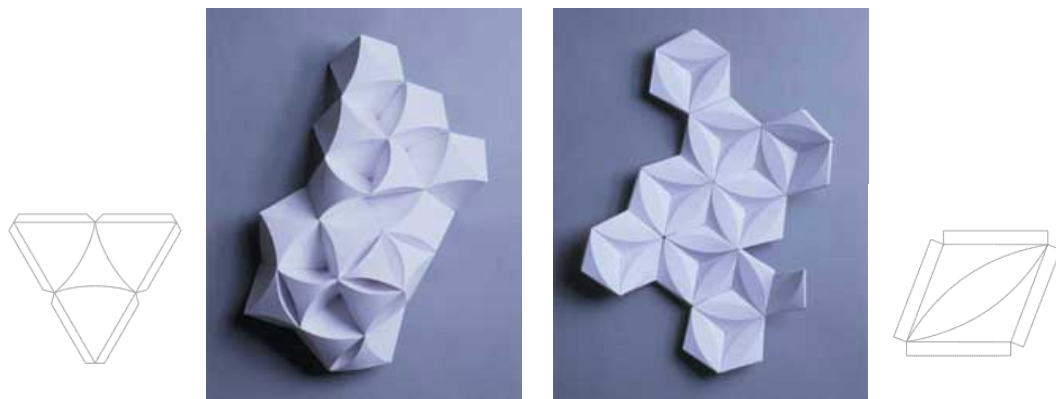
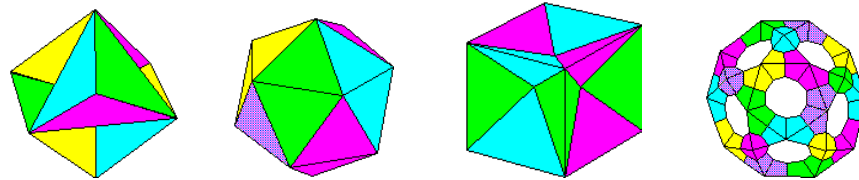

Figure 2.42: Modular surfaces, (<http://www.enlaihooi.com/images/jpges/>)

**Modular polyhedras** are constituted by using identical multiple sheets in different colors, which are folded into similar units with identical starting shapes. Polyhedral forms shown in Figure 2.43.a provides an excellent way to model many Platonic, Archimedean, rhombic and other polyhedras. Macro-modular forms shown in Figure 2.43.b are a development of modular origami in which a number of complete modular assemblies are combined to form integrated second-generation structures. Polyhedral combinations are forms created by combining several simple polyhedral forms to create a more complex shape. Edge-to-edge combination of four cubes is shown in Figure 2.43.c. The modular structures like containers or boxes called as Non-Polyhedral forms. The triangular lidded box shown in Figure 2.43.e is a design by Tomoko Fuse.



Skeletal Forms      Flat-faced Forms      Dimpled Forms      Hybrid Forms

(a) Polyhedral forms

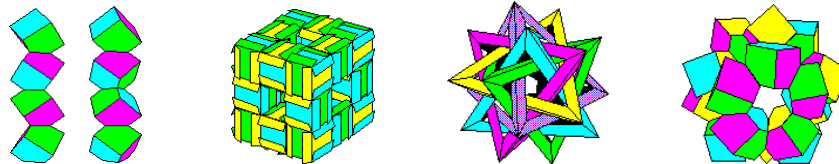

Stacks      Lattices      Interwoven      Un-mathematical Forms

(b) Macro-modular forms

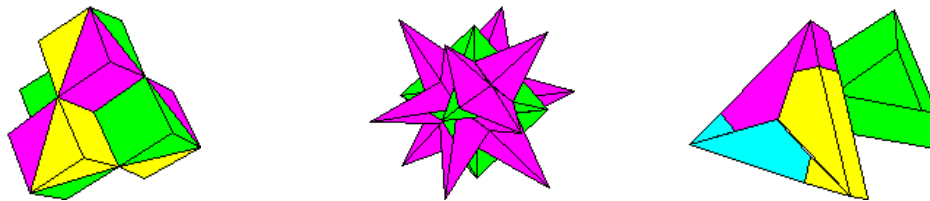

(c) Polyhedral Combinations      (d) composite structures      (e) Non-Polyhedral forms

Figure 2.43: Modular structures, (<http://www.mizushobai.freemove.co.uk/technicalmanual.htm>)

Another type of modular polyhedra is called as ‘multi-piece’ or ‘composite origami’. These structures consist of multiple sheets, which folded into completely dissimilar units by different folding methods and/or by different starting shapes. Andromeda (see Figure 2.42.d), designed by David Mitchell, is a good example of a composite modular structure. The design combines two distinct elements: a twelve-pointed star and a nolid (solid have no volume) octahedron, which are produced from by using two quite distinct folding geometries.

## 2.6 Concepts on Origami Design and Origamic Structure

“Unity is the visual glue that holds everything together.”

Rowena Reed Kostellow

**Unity** is the fact of forming or being united into ‘one whole’ or ‘an undivided whole’. In everyday application, unity may be understood as the bringing together of

many things into an arrangement that makes them appear as one, with all that so saying implies for harmony, cohesion, and accord. Unity, like integrity, denotes wholeness.

“**Wholeness** basically means the quality of being well shaped, both in reality and in appearance, in the art criticism of the ancient Greeks” (Johnson, 1994, p. 97). In design, it means that a completed structure consists of parts arranged in symmetry with the whole.

**Simplicity** is the form, state, or condition of being composed of a single structure and an absence of complexity, intricacy or adornment. The quest for unity and purity in designing is usually linked with the achievement of simplicity in artifact. Simplicity and homogeneity to give rise to purity through the clarity of function, honesty of material, transparency of production, and the consistent application of analytical methods

Simplicity does not imply a simple process, though it may be the result of one that progressively and efficiently simplifies the task (Johnson, 1994, p. 107).

Unity and simplicity have been equated in the underlying order to so-called Platonic solids: the five regular polyhedra.

**Abstraction** is a term means literally ‘draw off’ besides ‘draw away from’. What is drawn off is the essence, the distinguishable aspects of objects, and what is drawn away from is the concrete, complex, variegated, full-color actuality. In design, abstraction is achieved by using simple arrangement, primary forms, pure geometry, and lightness that satisfy bare necessities. Abstract shapes and forms are those in which the essence of an object has been extracted and expressed (Johnson, 1994, pp. 331-332).

**Pliancy** is another concept that determines the embodiment and incorporation of disparate elements by an external force. Smoothness implies pliant integration of these differences rather than representing them by collision of forms. “The smooth spaces described by these continuous yet differentiated systems result from curvilinear sensibilities that are capable of complex deformations in response to programmatic, structural economic, aesthetic, political and contextual influence. A logic of curvilinearity argues for an active involvement with external events in the folding, bending, and curving of form.” (Muyan, 2003, pp. 102-103)

**Modularity** is a concept that inspired from the richness of nature derives from simple structures, such as cells, joined repeatedly to form elegant patterns. Modular construction uses a relatively simple element, or module, and repeatedly attaches copies of that element to one another in order to construct complex forms. Usually the more

modules or sets of modules that are attached, the more complex is the resulting form. In origami however, the word 'module' still implies that the units are either all identical or occur in sets of complementary units making up identical sub-assemblies or at the very least are similar in that they begin from the same basic folds.

## **CHAPTER 3**

### **ORIGAMIC STRUCTURED INDUSTRIAL PRODUCT**

Folding a sheet leads to an interesting form that could easily be turned into a useful object. The process is simple: a flat sheet is cut into a certain shapes depending on the function of the object, and then folded into a decided form. One of the discoveries made with this experiment is the self-holding of the forms in two distinct ways such as strengthening the material by bending or creating a self lock structures by considering the elasticity of thin sheets. Such products are rich in functioning as well as they have added value of a low production cost. Using these simplified solutions as well as economical manufacturing processes that do not rely on high investments, will lead to producing internationally competitive products through the design of new forms.

#### **3.1 Definition of Origamic Structured Industrial Product**

In the scope of this study onwards, the term ‘origamic structured industrial product’ is use to determine the industrial products which are designed by considering origami design concepts, principles, techniques and made from the two dimensional sheet materials such as sheet metals, plywood, plastic based sheets or paper based sheets, and also formed by one-axis straight line bending techniques.

#### **3.2 Overview on Origamic Structured Industrial Product**

In this section, in order to draw a conclusion about the typical characteristics of these products, origamic structured industrial products has been analyzed by classifying them into four main groups in respect of what material they had been made from.

The nature of the thin sheet materials enables to design the products, which has a rigid structure in the folded state, whereas it transforms into a flat sheet in unfolded or flattened state. This flexibility characteristic of the thin sheet materials wins especially in packaging, so transporting costs. Consequently, by considering these advantages, the origamic structured products made from sheet metal and plastic sheet had been classified as secondary whether it is flat-packable or not. The products made from

paper-based materials have not been classified in such a way, because all of them are already flat packable.

### 3.2.1 Origamic Structured Sheet Metal Products

Because of their relatively low cost, high strength, and short lead times for tooling, formed sheet are important to industrial designers. Sheet metal is used mostly in large or small home appliances. It is also important in residential and office furniture or accessories and in commercial showcase and displays.

#### Flat packables

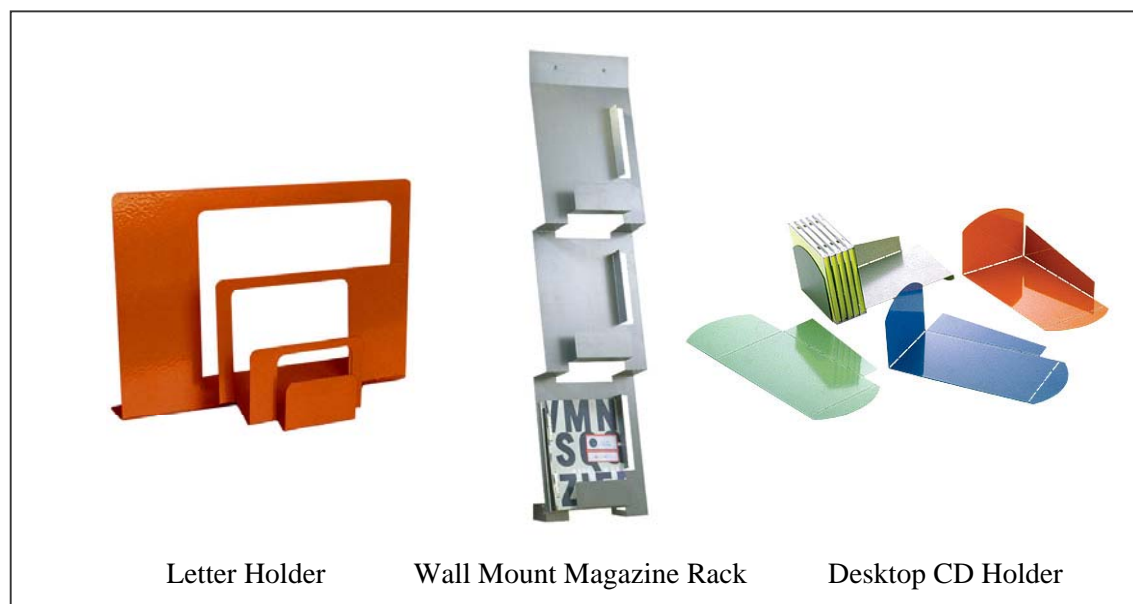

Figure 3.1: ‘2D:3D’ Office accessories, designed by Charlie Lazor, 1999, Manufacturer: Blu Dot, (Byars, 2003, pp. 24-27)

‘2D:3D’ desktop accessories made from 0.9 mm cold-rolled powder coated steel have a structure like pop-ups (see Section 2.5.1.1), in such a way the layers of certain cuts are overlapped on top of one another with some protruding portions. These products are purchased as flat pieces, and then end-users are expected to bend the objects into shape. Hence the name of the collection is ‘2D:3D’, in other words, two dimensions into three dimensions. ‘2D:3D’ products figure out how to keep two-dimensional sheet flat and to let the consumer do the three-dimensional bending operation. Cold-rolled steel is preferred by means of its elasticity in bending. The lines



that will be bent are perforated into the cold-rolled steel by laser cutting in order to make the sheet weak enough to bend by only the pressure of a hand, but strong enough to hold together as a rigid form. In this regard, both a functional and programmable surface, and also a structure are created by a single stroke. This perforating strategy wins in the cost and in flat packing, furthermore, makes assembly as an interactive event (Byars, 2003, pp. 24-27).

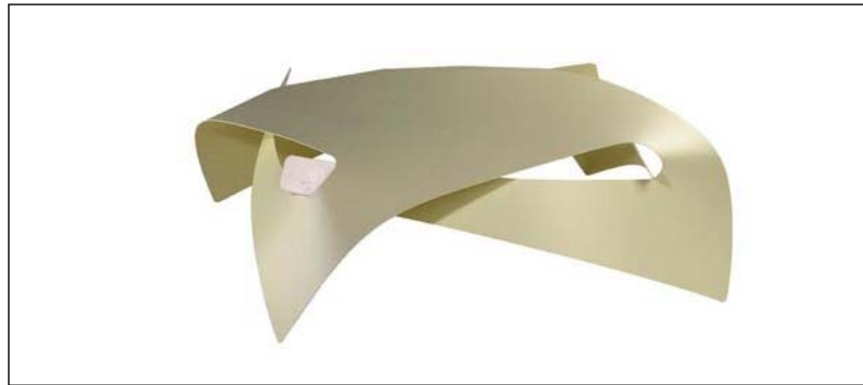

Figure 3.2: Square Dance Low Table, designed by Ronen Kadushin, 2000, (Byars, 2003, p. 63)

Steel is both strong and elastic in thin sheets. Square Dance Table, which was designed by considering this elasticity, has a self-lock and flat packable structure. The 1,5mm-thick flat sheet, which is cut in a certain shape by computer numeric controlled laser beam, can be formed into a three-dimensional form by hand bending (Byars, 2003, p. 65).

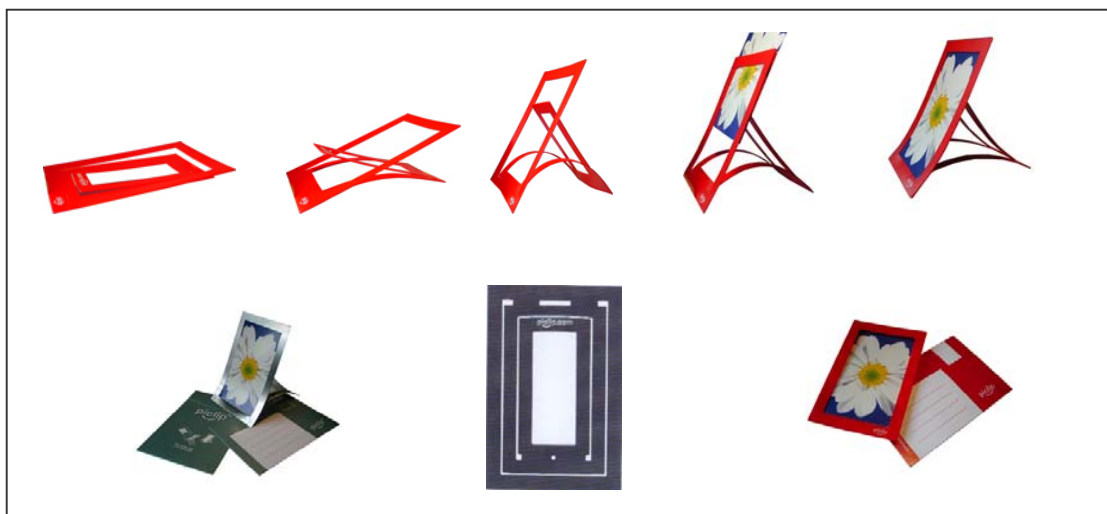

Figure 3.3: Piclip, designed by Chris Smith, 2002, Manufacturer: Piclip Ltd., (Byars, 2003, p. 113)

Piclip is a frame made from 0.25 mm brushed stainless steel that designed to be supplied with its own envelope and sent flat through the post. The recipient then bends the piclip and inserts the photo. Owing to the elasticity of the thin steel sheet, Piclip always return to its original flat form. Its springy structure is obtained by punched out ‘U’ shape in one direction, another ‘U’ shape punched out in the opposite direction.

### **Non-flat packables**



Figure 3.4: Prismatic Table, designed by Isamu Noguchi, 1957, Manufacturer: Alcoa  
(<http://www.hivemodern.com>)

Prismatic Table was designed in 1957 to explore new uses for aluminum. Its design philosophy is originated from the ancient Japanese art of paper folding translated to the modern Western material of metal. This table has a polyhedral modular structure (see Section 2.5.2) consists of three identical unit forms, which is bent in exactly same manner.



Figure 3.5: Fly, designed by Mehmet Ermiyagil, 2004, Manufacturer: Derin Design  
(<http://www.derindesign.com>)

Fly low table was designed by considering the Blintz fold, which is one of the basic folds of origami design. Blintz fold (see Figure 2.15) is a technique that is the folding of all four corners of a square into the center. The form is pretending to be a flat foldable paper. By means of its geometric structure, Fly denotes great simplicity and integrity in designing process, in manufacturing process, and also in functioning.



Figure 3.6: Tufold, By Scot Laughton, (<http://www.nienkamper.com/product.asp?prodcats=>)

The single sheet of aluminum cutout is formed into a table by the basic techniques of origami design: cutting and folding. In spite of Tufold has a light aesthetic; the strength of the material is increased by one axis line bending process in both two sides.

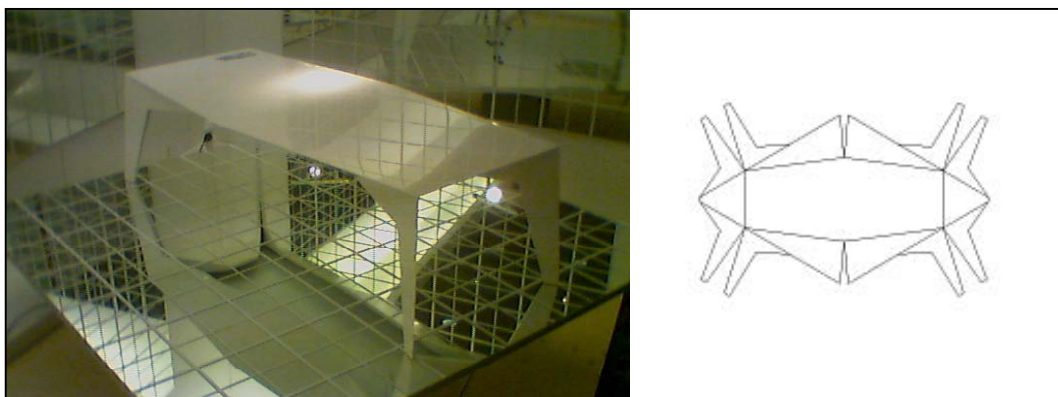

Figure 3.7: Origami P1 Table, AD Design Fair 2004: Best Designer Award, by Mehmet Ermiyagil ([http://www.trendsettermag.com/template.asp?baslik\\_id=567](http://www.trendsettermag.com/template.asp?baslik_id=567))

In the design of P1 Origami Table, the traditional material had been taken up in unusual manner. The unfolded polygonal crease pattern of this table has been created by the assisting of TreeMaker computer based origami design tool (see Section 2.1.2). Although it is plain and systematic, its structure makes the watcher curious.



Figure 3.8: Noan, designed by Gualtiero Sacchi, 2004, (<http://www.moreproject.com>)

These multipurposed table systems shown in Figure 3.8 and Figure 3.9 are formed by a combination of v die bendings (see Section 3.3.1.3) at different bending angles.

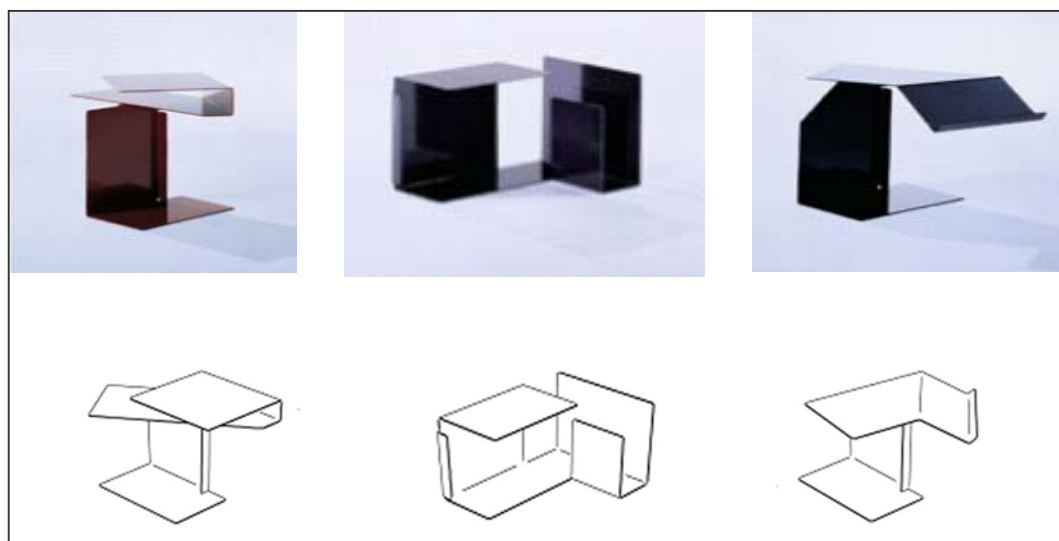

Figure 3.9: Diana side table series, Red Dot Award: Product Design 2002, designed by Konstantin Grcic, 2002, Manufacturer: ClassiCon, (<http://www.reddot.de>)

### 3.2.2 Origamic Structured Plywood Products

Plywood was put into commercial production in the 1850s. Due to it was cheap and easily accessible, plywood has been an important medium for making cheap mass-producible furniture from the 1920s onwards. During World War II, plywood became more versatile with the introduction of new synthetic glues and its quality, flexibility and durability were improved. In the 1950s, bent plywood was used mainly in seating by combining with metal or solid wood supporting structures, besides in medical equipment such as leg splints, and also for aircraft sections. In the 1960s and 1970s, plywood fell from favor due to popularity of plastic. However, owing to the young Scandinavian furniture designers of the 2000s, it gains popularity again.



Figure 3.10: Plywood Armchair, designed by Gerald Summers, 1934,  
(Marcus & Hiesinger, 1993, p. 129)

Plywood armchair shown in Figure 3.10 is one of the earliest examples of a chair made of single-piece construction designed by considering the cut and fold idea. It has a pop-up structure with double slits that are fold into different level. After parallel cuts in the single sheet of plywood; legs, seat and arms are bent in opposite directions into their fluid shapes. By eliminating joinery and upholstery, the problems of weakened joints and rotting caused by humidity is avoided. “The rounded, continuous shape into which this single sheet is formed gives an aerodynamic, streamlined effect softened by elements that described as organic or biomorphic at a later date” (Marcus & Hiesinger 1993, p. 129).

### **Non-flat packables but impressively stockables**

Due to the nature of the bent plywood, the product made from plywood has strength rigidity. Consequently, in order to get advantage in packaging or transporting, it should better considering to design it stockable or modular. In this regard, it can be said that the modular structure shown in Figure 3.11 is almost flat foldable, and the others shown in Figure 3.12 and Figure 3.13 are impressively stockable.



Figure 3.11: Capelli Stool, IDEA Industrial Design Excellence Award 2002: Silver, designed by Carol Catalano, 2002, (<http://www.idsa.org>)

The stool's design consists of two identical bent plywood pieces with undulating "fingers" matched at the top. The pieces interlock without tools or fasteners to form an ingeniously stable and remarkably strong structure. It unfolds and the two halves stack together conveniently for easy shipping and storage.



Figure 3.12: Bend Table, designed by Mehmet Ermiyagil, 2000  
(<http://www.derindesign.com>)



(a) Eco chair, iF Ecology Design Award 2000: Best of category



(b) Tri chair

Figure 3.13: Voxia Series, designed by Peter Karpf 2000, (<http://www.scandinaviandesign.com>)

Eco chair is an image of the ecological and economical potential of the bent plywood. To constitute this pop-up structure, two parallel slits cut to form thin back legs, and then this single piece of plywood is folded three times at near right angles. Tri chair creates origami-like space and depth out of a curved surface.

### 3.2.3 Origamic Structured Plastic Sheet Products

Polypropylene sheets have been around virtually anonymously in the public's knowledge since 1950s. As sheet it has provided the opportunity for plastic products to be made from paper process like folding, cutting and creasing with the result that products need minimal investment in tooling. As a result it has become extensively used in all forms of packaging. Polypropylene sheets offer a range of colors and printing processes that can be used to give this material endless potential to create new forms for everyday products. (Lefteri C., 2001; pp. 45-50)

## Flat Packables



Figure 3.14: Fluent, designed by Studio Platform, (Asensio, 2002, p. 63)

The seating of Fluent chair has been designed by considering origami design concepts, principles and techniques. In such a way, its seating surface has been obtained by a simple tessellation (see Section 2.4.4). In the manufacturing process of this seating, firstly the crease pattern of the tessellation is scored (see Section 3.3.4) on the 2 mm polypropylene sheet. Then it is bent by hand easily. This bending adds strength to the polypropylene sheet. For assembling the furniture, the bent polypropylene sheet is threaded over two leg profiles. Thus, a distinctive and high value aesthetic is created by a cost-effective assembling. The plastic sheet can also be upholstered with polypropylene sheet cloth to add higher end appeal.

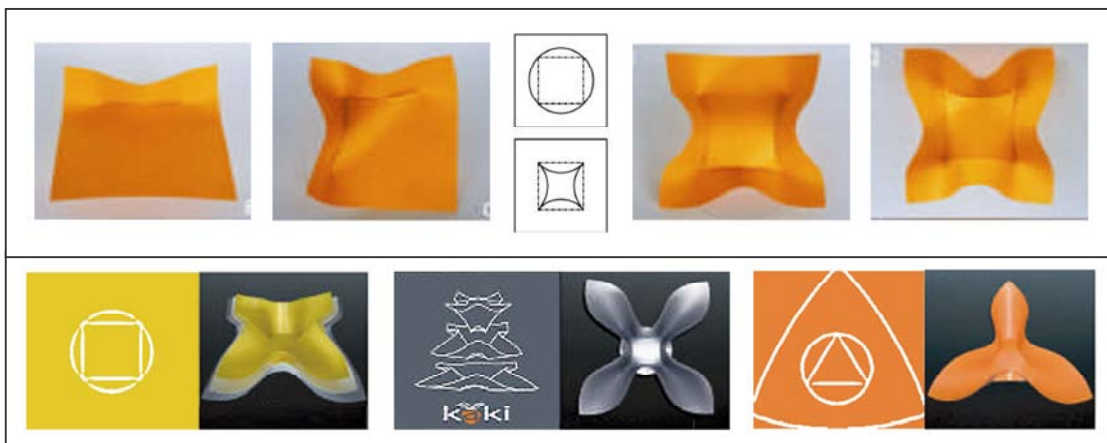

Figure 3.15: Self Lock Kaki, designed by Naoko Takeda, 2000, (Takeda, 2000, p. 8)



The 'Self Lock Kaki' shown in Figure 3.15 is a self lock container made from polypropylene sheet. The principle behind it lies in the variation in the dimension of the curves, the length of the straight lines and the number of lines that make the unit, thus obtaining greater efficiency in the lock. The Self-lock Kaki responds when the curve and the straight folds intersect each other, even in an imaginary way, for example on a paper, the Self-lock Kaki can be obtained with a curve and a straight line acting as a chord. If the straight line is not chord of the curve, there will be no self-hold. The effect is also dependent on the radius of the curve, the position with respect to the straight line and the material employed. Taking this as a pattern, and activating the folds, the following sequence results in the kaki container. If a force is applied in a well distributed manner across its surface, the self hold is reaffirmed, but if a vertical force is applied in the center of the folds, the Self-lock Kaki lose their effect, and the material returns to its original state. The result is a self-locking, hinge and clip structure. Curved folding bends toward the opposite direction against the straight folding. Once folded, the structure converts into clip and hinge. By simply pressing the two extremes of the hinge with fingers, the clip opens and by loosening it returns to the original position. As the radius of the curve turns smaller, the container will be deeper. It doesn't require any type of slit or utilize any technique of joint, such as adhesive or glue, thermal sealing, soldering or any other extra elements like staple, screw, nails, rivet, etc. (Takeda, 2000, pp. 2-10).

The City Knife II shown in Figure 3.16 and the flat foldable sandal shown in Figure 3.17 are other examples of flat packable products. These products express how the flat packability concept is find application in two distinct manners.



Figure 3.16: City Knife II, designed by Kirsten Schambra, 1998, Manufacturer: Nike  
[http://www.metropolismag.com/html/content\\_1203/nik/htm](http://www.metropolismag.com/html/content_1203/nik/htm)

City Knife II is a lightweight foldable shoe that can literally be stashed in back pocket. The idea added creases to the form that, when unfolded, create structure. Its foldable structure is based on the crease pattern that is obtained by the repetitive preliminary fold (see Figure 2.28). The triangle-shaped pods provide rigidity by creating a kind of exoskeleton.



Figure 3.17: Flat foldable Sandal, (Photographed by Serdar Deniz)

### Non-Flat Packables

Acrylic or polymethyl methacrylate sheet, which was initially commercialized in the early 1930s, is a glassy thermoplastic rigid sheet that has positive characteristics such as weather ability, ease of fabrication, lightweight and non-yellowing. Industries have found it to be a good material for applications that require high impact resistance and good weather ability. One of its most popular markets is POP displays and store fixtures. It also is used nearly everywhere in shopping malls around the world in signage and displays. Due to the affordability of this product as well as its flexible design capabilities, acrylic is a perfect match for this market.

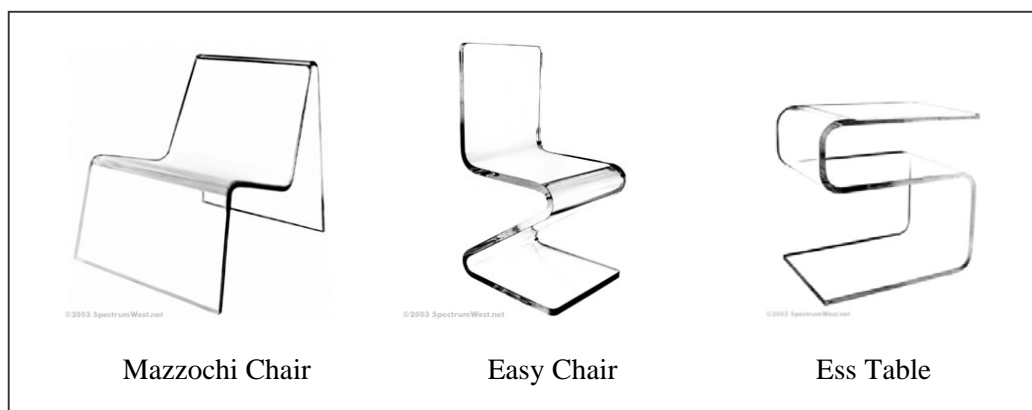

Figure 3.18: Acrylic Series, designed by David Ross, 2001, (<http://www.hivemodern.com>)

This clear acrylic furniture embody the minimalist aesthetic most purely due to the severe reduction of form and structure. Each piece is completely transparent and derived from one solid piece of material by one axis hot line bending (see Section 3.3.3).

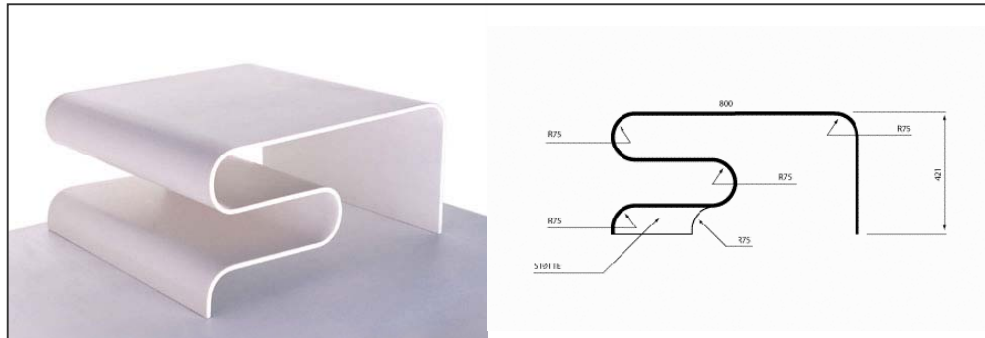

Figure 3.19: Folder Coffeetable, designed by Ole Petter Wullum & Arnstein Sarset, 2002 (<http://www.sarsetdesign.com>)



Figure 3.20: Flov Series, designed by Mirzat Koç, 2003, (<http://www.flov.com>)

Corian is another engineered thermoplastic sheets that can easily be formed with hot line bending. Its traditional use as a kitchen work surface actually. Its non-porous surface means it is also hygienic. But recently this sheet material has come out of the bathroom and kitchen and on to the industrial product design scene. Folder coffee table and Flov Series are products made from Corian sheet by hot line bending. (Lefteri, 2001, p. 55)

### 3.2.4 Origamic Structured Paper Based Sheet Products

A sensitivity to the use of new materials and the implications of those choices were thrust into the forefront by the oil crisis of 1973, which underscored the urgent

need to conserve the earth's dwindling natural resources. In a search for practical alternatives to complex, high-energy materials and industrial processes, certain designers focused on readily available materials such as cardboard and other recyclable industrial wastes.



Figure 3.21: Spotty child's chair, designed by Peter Murdoch, 1963, Manufacturer: International Paper Corporation, New York, (Marcus, 1993, p. 228)

Peter Murdoch's Spotty child's chair was the first piece of commercial furniture made of paper. Inexpensive and durable, the chair sold as flat, brightly ornamented, and laminated sheets in supermarkets and department stores to be assembled at home simply by folding along 'pre-scored' (see Section 3.3.4) lines and inserting the tabs to make a solid form.

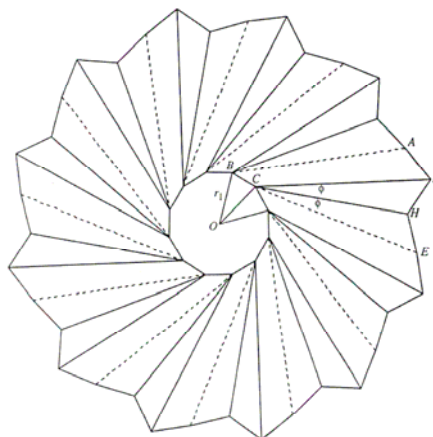

Figure 3.22: Sturdy paper pot, designed by Tomoko Fuse, (Cipra, 2001, p. 2)

The sturdy paper pot shown in Figure 3.22 can be made from a single sheet of paper without the use of any glue. In the illustration, the dashed lines in this case are guidelines only. The solid lines are alternately mountain and valley folded. A key concept is that the folds creating the sides of the pot do not radiate directly from the center the paper pot must flex as it's being folded and, ultimately, "snaps" into position. The pot easily unfolded by pulling outward on one edge of its rim, but as that section of the pot unfolds, portions of other sections must flex slightly inward. When the pot is filled with a liquid, an outward force is applied equally in all directions and the sides stiffen because they are unable to flex inward. Large, sturdy, and glueless paper pots coated with a synthetic resin film or other water-repellent material could be an economically viable and environmentally friendly solution to the problem of disposable containers (Cipra, 2001, p. 2).

### **3.3 Forming Two Dimensional Material Into Origami-Like product**

Materials are formed in three different states such as liquid state, plastic state and solid state. In a liquid state forming, raw materials are melted completely and then injected into a mould. In a plastic state forming, pre-shaped materials are heated below the melting point in order to form them easily. Plastic state forming process is often labor intensive, but the advantages of this process is the enhanced strength achieved in the part. Solid state forming process, normally limited to sheet, rod, and tube, is done at room temperature, and also by means of technological developments, it can be fully automated. In this regard, solid state forming brings about the opportunity of productive and sustainable manufacturing process. The two dimensional materials such as plywood and thick plastic sheets are formed in a plastic state; whereas sheet metals, paper and thin polypropylene sheets are formed in a solid state. Conceptually it may be useful to think of one-axis sheet bending as being somewhat similar to bending paper. Bending sheet material along one plane is a fairly inexpensive operation that creates simple shapes and gives the sheet some rigidity and strength. (Lesko, 1999, p. 50)

#### **3.3.1 Sheet Metal Bending Process**

A sheet is normally defined as metal that is less than 6 mm -0.25 inch- thick (T). A sheet thicker than 6mm is generally called a plate.

Sheet metal forming usually involves relatively thin materials that are available in wide variety of thickness. It is thin, hence low weight; sheet metal products require little material. Briefly, low material cost and relatively small inventory and ease of transport are the advantages of using sheet metals.

Sheet metal is easy to cut by punching, nibbling, laser cutting, and plasma cutting, and also easy to reshape by press brake bending, deep drawing, pressing, and roll forming. In other words, by means of its good machinability property, it is required relatively little power and energy for cutting and reshaping of sheet metals. In addition, sheet metal can be joined in many ways by riveting, screwing, and folding, whereby parts from sheet metal have ease of assembling and demounting. In addition to these advantages, sheet metal is also recyclable and environmentally safe.

As a result, all of the advantages above-mentioned arise from the nature of sheet metal and bring outcomes as sustainable products. (Bitzel, 1996, p. 24)

Sheet metal forming by Press brake bending is a solid state forming process done at room temperature, in which a metal work piece is bent along a straight line. By means of this forming process just requires electrical energy, it also brings sustainability to manufacturing phase.

Although sheet metal bending is normally labor intensive, new developments with automated computer-controlled tooling and sheet handling has drastically cut down the process time and manufacturing cost. (Lesko, 1999, p. 23)

Compared to other manufacturing processes like casting, forging, machining and welding, forming has several technical-economic advantages that are explained in below.

The products made by sheet-forming processes include a large variety of shapes and sizes, ranging from simple bends to complex double curvatures. It is difficult or even impossible to obtain this variety by other techniques. Furthermore, press brake tooling is simple and adaptable to a wide variety of shapes

Driven by the ideal of a near net shape, in other words removing a piece from the press brake whose form is as near as possible to the finished product, sheet metal forming provides the opportunity of producing pieces in an economic way. In this way the work piece, which does not require any further cutting, is cut from the sheet. In most instances formed sheet metal parts do not require additional mechanical processing. Press brakes provide the possibility of creating products that ideally all welding joints can be replaced by bending process. Folding instead of welding obtains decreasing in

production time. In addition, because of there is always the danger of distortion in welding; folding instead of welding also prevents the material casualty. By means of sheet metal bending, it is also possible to use the same pieces despite different functions. Thus, it is obtained the decreasing in the piece numbers and simplified storage (Bitzel, 1996, p. 110).

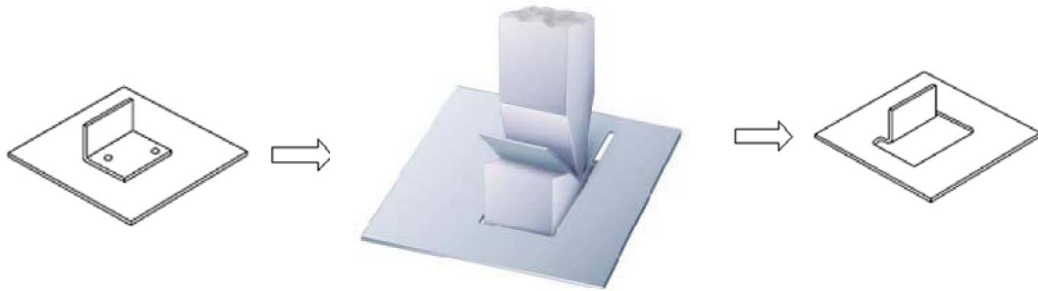

Figure 3.23: The same pieces despite different functions, (Bitzel, 1996, p. 24)

Besides these advantages, the dimensional accuracy of sheet metal parts ensures their exchangeability in assembly, and also the mechanical properties of formed very light sheet metal parts are increased by strain hardening

Consequently, because of its economic efficiency in mass production, in such a way that final products in desired shape and appearance can be quickly and easily produced with relatively simple tool set, and also automated and numeric controlled press brakes allow high production rates by fast operation, sheet metal forming is widely being employed in almost all industrial fields. (Bitzel, 1996, p. 24)

**Sheet metal process chain** is described as the manufacturing process of a sheet metal part from its design to its completion as a finished product. Producing the high-quality product quickly and economically is achieved by the using of fully developed machine technology and a productive sheet metal processing chain from the design phase to the time the product is delivered to the costumer.

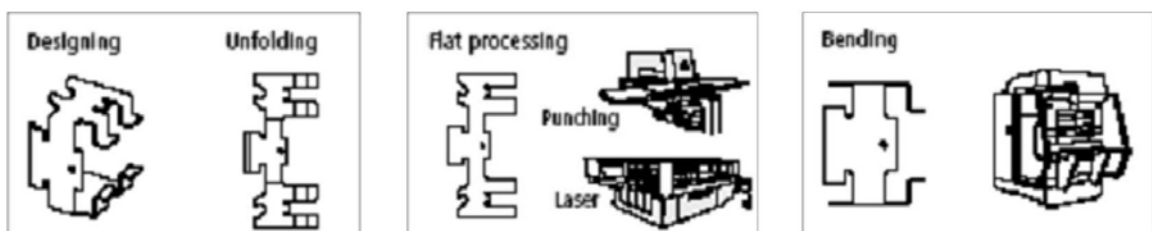

Figure 3.24: Sheet Metal forming process, (Bitzel, 1996, p. 16)

The process chain for sheet metal forming is divided into three areas that are ideally linked the each other, such as designing, flat processing and bending.

### 3.3.1.1 Designing Sheet Metal

The process chain begins with the design. Sophisticated design systems support the designer by providing photo realistic 3D models. The final form decided on is converted into a developed view in the end of the design process. This 3D developed view is unfolded automatically into 2D drawing by a 3D CAD system. And then this 2D drawing is developed automatically into 3D models again by taking the available tools and folding sequence into consideration. Thus, it possible to determine the problems such as cross section, overlapping, or missing cutouts beforehand production. The 2D drawing of the faultless unfolded state is passed on to the programming system for flat processing (Bitzel, 1996, p. 16).

In principle, designing sheet metal is not different from other semi-finished products such as solid stocks, metal profiles, or parts that have been cast or forged. Only by considering the characteristic of sheet metal and the advantages afforded by modern sheet metal processing in the design process, a functional and economically manufactured product is obtained (Bitzel, 1996, p. 22).

Some characteristics and mechanical properties of sheet metal, which should be considered in material selection and also which affect on the bendability, are **plasticity**; that is the ability for metal to be permanently deformed and to hold the new shape without breaking, **elasticity**; that refers the resiliency of a metal to return to its original shape when a stress is removed after being deformed, **machinability**; that is the ease with machining or cutting by machine tools, **ductility**; that is the ability of a material to withstand plastic deformation without rupture, **brittleness**; that refers to how easily a metal will break with little or no bending, in this way, opposite of ductility, **hardness**; that is the ability of a material to with stand scratching, and **toughness**; that is the ability to withstand sudden shocks without breaking. In such a way that tough materials could bend without breaking, on the contrary very hard materials will become brittle and break easily (Lesko, 1999, pp. 7-8).

There are also lots of fundamental hints to be considered on sheet metal design process. For instance, the most effective way to save material is to reduce the sheet thickness. This results not only in less weight, but also in reduced production times.



Material costs are usually less significant than production costs in small and medium-sized series.

Processing time can be drastically reduced by common slitting cut in order to two neighboring parts can be separated with a single cut. And also a good material utilization has been achieved when it is possible to design the pieces so that they can be cut out of the sheet by a single separating cut without waste. Nesting programs allow good sheet utilization very quickly.

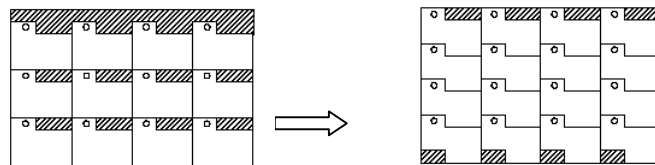

Figure 3.25: Saving material by using an optimized placement strategy, (Bitzel, 1996, p. 28)

Because the laser can traverse the rounded corner more quickly and evenly than a pointed one, rounding outer and inner corners is another hints to reduce processing time and to get flawless cutouts.

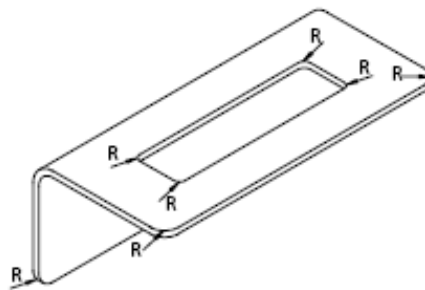

Figure 3.26: Rounding outer and inner corners, (Bitzel, 1996, p. 28)

If a part of an inner surface is to be bent upwards, it is advisable to notch the bending zones in addition to be slit. This not only makes a flawless bend, but also allows a greater tolerance when selecting and placing the bending tool.

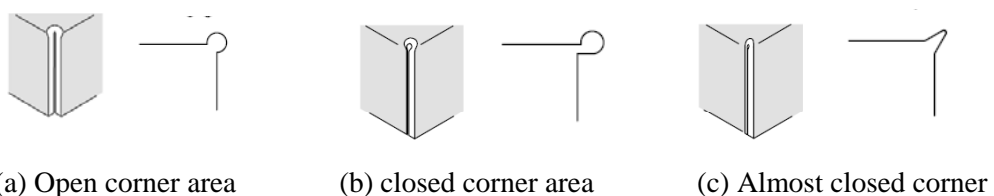

Figure 3.27: Notching the bending zones, (Bitzel, 1996, p. 28)

If the designer uses, as many standard geometric forms as possible for which there are standard tools, the setup time is greatly reduced.

When designing a sheet, it should also be considered the possibility of making large inner cutouts in order to use waste part further for producing the smaller finished parts.

Besides these design considerations discussed above, there are also important factors must be considered such as bending radius, shortening factor and resiliency (Bitzel, 1996; 26-28).

**Bend radius** is the most important factor in sheet metal bending. In bending, the outer fibers of the material are in tension and the inner fibers are in compression. “The minimum bend radius for the material is the radius at which a crack appears on the outer surface of the bend. It is usually expressed in terms of the thickness, such as 2T, 3T, 4T, and so on. In bending sheet there is a rule of thumb wherein the radius of the bend is related to the thickness of the sheet—a 2T bend means that the radius should equal two times the thickness of the sheet ( $=2 \times T$ )” (Lesko, 1999; 48)

The smallest possible radius is determined by the material. Generally, materials that can be easily formed can be bent at a smaller radius than brittle materials such as mild steel or magnesium alloys. As a rule of thumb, it can be assumed that the minimum-bending radius must be larger than the sheet thickness. (Bitzel, 1996; 109)

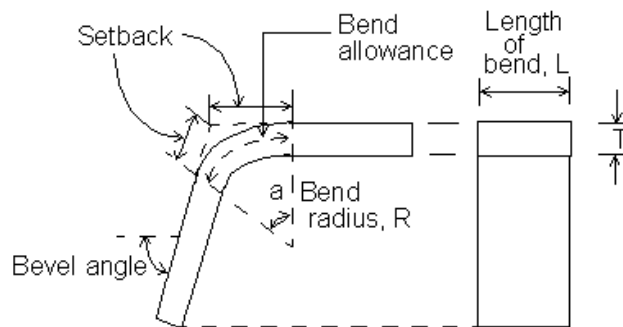

Figure 3.28: Bend Radius, (Bitzel, 1996, p. 109)

Shortening factor is another design consideration in bending. The material distribution of a work piece is altered when it is plastically reshaped. A designer must take this effect into consideration while calculating the developed view of a product. The legs measured on the outside of the bent work piece are longer than in the developed view. To calculate the elongated lengths of a bent work piece, a shortening factor must be subtracted from the sum of the leg lengths.

Angles smaller than  $65^\circ$  can even have a negative shortening factor. The designer must be informed of the empirically calculated shortening factor that depends on material thickness. (Bitzel, 1996, p. 105)

$$L = a + b - \Delta x \quad \text{whereby } L = \text{elongated length and } \Delta x = \text{shortening factor}$$

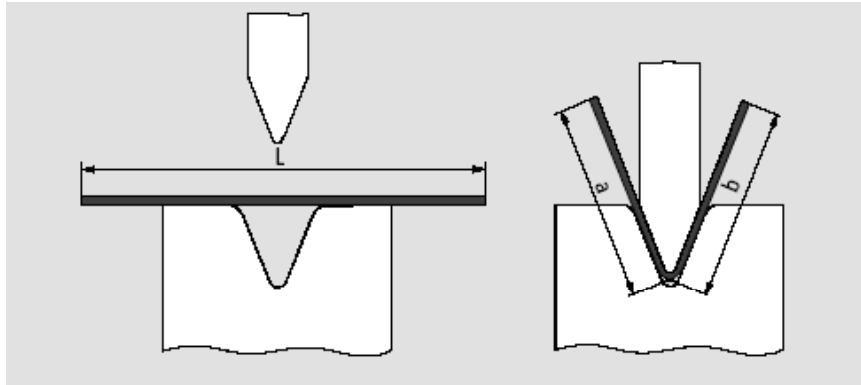

Figure 3.29: Elongated length  $L = a + b - \Delta x$ , (Bitzel, 1996, p. 105)

**Resiliency**, in other words spring back is the tendency of the sheet to bend back into its original shape once pressure has been removed from the punch. In practical terms, the sheet must be bent at angle smaller than the angle desired. The more the sheet is bent, the fewer resiliencies will be encountered. Thicker sheets are less resilient than thinner ones; and also stronger materials less resilient than weaker materials. (Bitzel, 1996, p. 102)

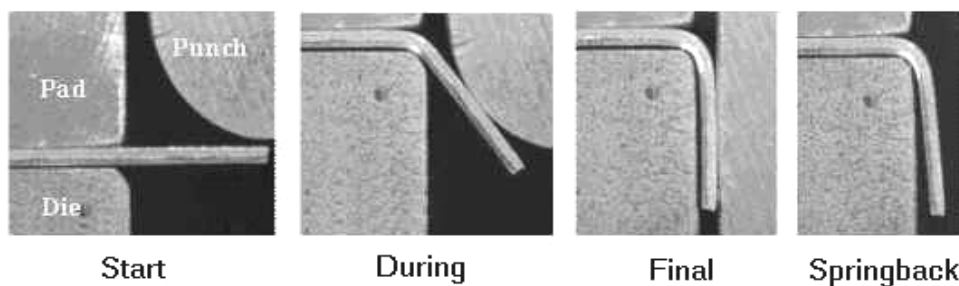

Figure 3.30: Resiliency (spring back), (<http://nsmwww.eng.ohio-state.edu/html/stamping.html>)

### 3.3.1.2 Flat Processing (Shearing Process)

The production phase of a work piece always begins with flat processing. The blanks are the first pieces to be manufactured from the raw sheet, which are then folded. The goal is to create the final form in as few steps as possible. That's why it is

preferable to have the entire flat processing done on a single machine. Modern multi-function machines offer this ability. The press brake does not come into action until flat processing has been completed. The quality of the bent part can be improved by straightening the blanks beforehand. By programming the bending process with the simulation of bending results and determining the tools to be used, setup and processing times are reduced during production. (Bitzel, 1996, p. 19)

Before a sheet metal part is formed, the work piece so-called “blank” that will be formed into the final part is removed from sheet metal stock. Sheet metal cutting processes includes a number of techniques. Common types of sheet metal cutting are electrical discharge machining, laser cutting, water jet and abrasive cutting. Laser cutting has also become an important process, so that it is used with computer-controlled equipment to cut a variety of shapes consistently.

Various shearing operations shown in Figure 3.31 can be classified as blanking, punching, and die cutting. In blanking the slug is the blank to be further processed whereas, the slug removed from the blank is not used to form the part in punching.

Die cutting is used to produce more complex blanks that might be the final part. This kind of shearing consists of the following operations: Perforation -punching a number of holes in a sheet-; parting -shearing the sheet into two or more pieces-; notching -removing pieces of various shapes from the edge-; lancing and slitting -leaving a tab without removing any material.

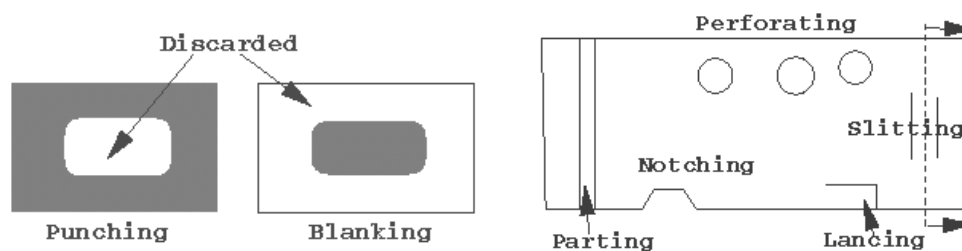

Figure 3.31: Various shearing operations, (<http://www.menet.umn.edu/>)

If the construction drawing has a large number of free geometric forms with many rounded corners and tangential crossovers, the part is manufacture with laser beam. If the vents are designed with simple standard geometric forms, for example, oblong holes arranged in a star shape, these forms could be processed with a punching machine equipped with tool rotation. If the vents are designed as lower slits, the formed areas can be created with punching machine and appropriate tools. (Bitzel, 1996, p. 18)

### 3.3.1.3 Sheet Metal Bending

Sheet metal forming by press brake bending is a process that a metal work piece is bent along a straight line. The major devices used for bending are presses and dies. Sheet metal bending operations involve placing sheet metal on a die up against a back gage to precisely locate the part. At this time, the machine is commanded to close the gap between the punches and die until the part is bent into the cavity of the die (Wang & Bourne, 1997, pp. 281-294).

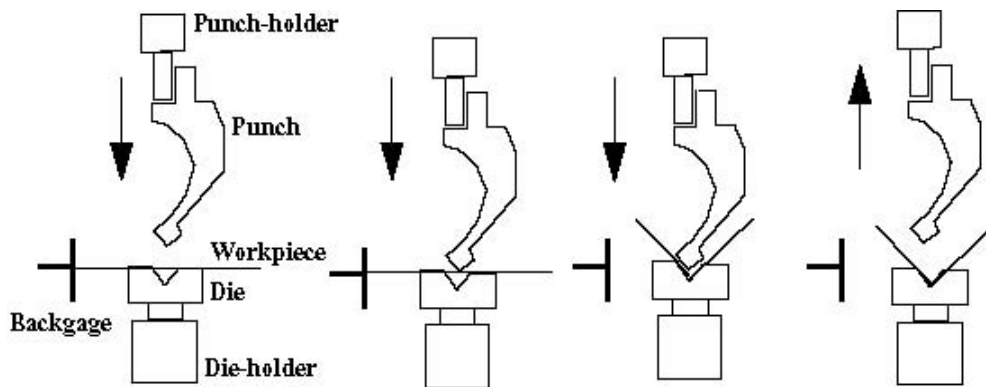

Figure 3.32: Bending process phases, (Wang & Bourne, 1997, p. 290)

The most common types of sheet metal bending are discussed in below with a comparative approach.

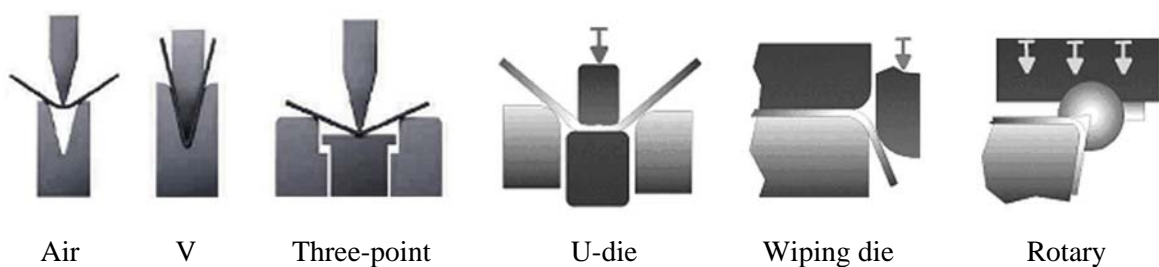

Figure 3.33: Special punch and dies for sheet metal bending

(<http://nsmwww.eng.ohio-state.edu/html/>)

**Air bending**, also known as free bending, is a process which a punch bends a work piece without pressing it to the bottom of the die. This process requires a relatively quite low press tonnage. However accurate control of the punch stroke is necessary to obtain the desired bend angle. In air bending, there is no need to change

any equipment or dies to obtain different bending angles, due to the bend angles are determined by just punch stroke. Thus economically priced machines can be used in free bending. In addition, wide variety of sheet thickness can be processed by air bending. Because of these economical aspects, free bending is the most widely used bending process. “Unique disadvantage of this bending is the spring back that usually ranges from 7° to 12°” (Bitzel, 1996, pp. 100-102).

In **V-bending**, the work piece is pressed completely into the die by the punch until it comes to bottom. The bending angle cannot be chosen independent from the tool, because the dimensions of the punch and die determine the angle. Because of each angle requires its own tool set, that results non-productive times for the machine in longer period, in such a way that, the tools have to be exchanged for each distinct bending angle. The smaller the lot size, the more critical this problem becomes. In addition, V-bending requires more machine power and higher press tonnage than air bending. Furthermore, the maximum sheet thickness can be processed by V-bending is considerably thinner than air bending. On the other hand, V bending has a great advantage than air bending, in such a way that, there are very little angle fluctuations with coining due to the fact that pressure at the end of the punching stroke is high enough to minimize the effects of resiliency.

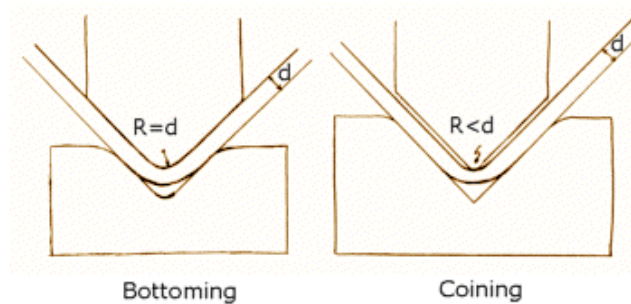

Figure 3.34: V bending styles, ([http://www.efunda.com/processes/metal\\_processing](http://www.efunda.com/processes/metal_processing))

In bottom bending, spring back is reduced by setting the final position of the punch such that the clearance between the punch and die surface is less than the blank thickness. As a result, the material yields slightly and the spring back is reduced. Bottom bending requires considerably about 60% more force than air bending. In coining, compressive stress is applied to bending region to increase the amount of plastic deformation in order to reduce the amount of spring back. Press tonnage for coining is three times greater than for air bending.

**Three-point bending** is differentiated from other bending process in particular by employing a special die base whose height can be adjusted in order to get different bending angels. In this way the lower the die bottom, the smaller the bending angle. The bent sheet makes contact with both the outer edges of the die and the base between the edges-viewed laterally, there is contact at three points. Three-point bending requires less press tonnage and more flexible tooling than coining and obtains nearly the same angle precision. However, These advantages are tempered by the considerable costs required for a complex control and tool technology (Bitzel, 1996, p. 102).

**U-die bending** is performed when two parallel bending axes are produced in the same operation. A backing pad is used to force the sheet contacting with the punch bottom.

In **Wiping die bending**, also known as flanging, one edge of the sheet is bent to 90 while the other end is restrained by the material itself and by the force of blank holder. The flange length can be easily changed, and also the bend angle can be controlled by the stroke position of the punch.

**Rotary bending** is a bending process using a rocker instead of the punch. The advantages of rotary bending are; requires less force, more than 90 degree bending angle is available, needs no blank holder, compensates for spring back by over bending. Besides press brake forming process, there are also several bending processes to form sheet metal such as beading, hemming, and rubber bending.

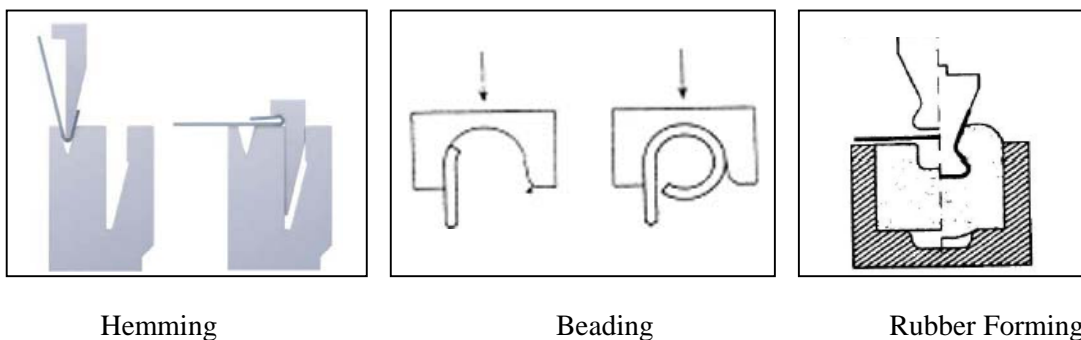

Figure 3.35: Special Bending Operations, ([www.web.nmsu.edu/~jcecil-IE217-VER2\\_.pdf](http://www.web.nmsu.edu/~jcecil-IE217-VER2_.pdf))

**Beading** is a process that the periphery of the sheet metal is bent into the cavity of a die. It improves the appearance of the part and eliminates exposed sharp edges, and also imparts stiffness to the part by increasing the moment of inertia.

**Hemming**, also known as flattening, is folding the edge over itself. This improves stiffness, eliminates sharp edges.

**Rubber forming** is bending of the sheet metal with a metal punch and a flexible pad serving as the female die. Low tooling cost, capability to form complex shapes, flexibility and ease of operation are the advantages of rubber forming. Surface damage of sheet can be avoided.

The press braking process can produce a variety of shapes. Some of the most common shapes appear, two-dimensionally, in Figure 3.36 below.

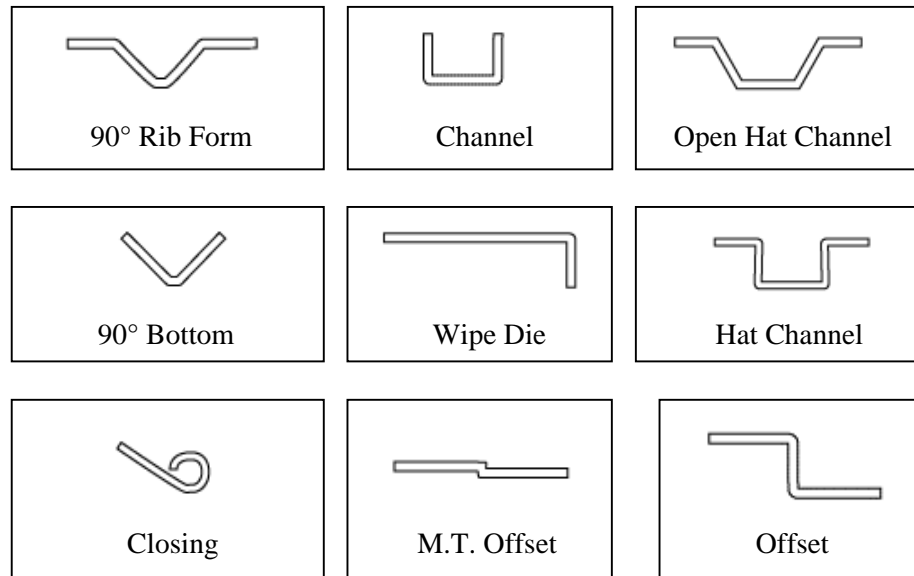

Figure 3.36: Most common forms, (<http://www.advantagemetals.com/press-braking>)

### 3.3.2 Plywood Bending Process

Plywood is a material constructed by gluing the thin sheets of wood together with the grains of adjacent layers running crosswise. It is composed of a minimum of three layers such as the back, the face and the core. Though three layers is the minimum, five-ply plywood; seven-ply plywood and multi-ply plywood are also available. Plywood is actually stronger than the wood itself by means of this cross-layered structure and the adhesives used to bond the veneers.

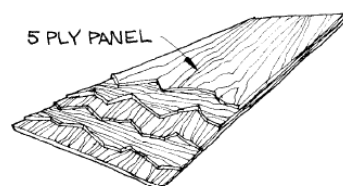

Figure 3.37: cross-layered structure of plywood, (<http://www.bentply.com>)



Plywood has many advantages in the point of sustainability and aesthetic view. Plywood manufacturing achieves a more complete utilization of the log than does lumber manufacturing. No sawdust results from either rotary cutting or slicing, which are the two most frequent methods of cutting veneer. Greater square foot coverage, in comparison to solid wood products, is achieved by using veneer; thus plywood manufacturing causes efficient use of a renewable resource. In other words, a product from plywood is environmental friendly. On the other hand, in the point of aesthetic view, it is attractive to the eye because of the natural characteristics of wood. The appearance of plywood defines imitation of nature, which is safeguarded as a precious asset.



Figure 3.38: Foiled and laminated plywood, (<http://www.cinal.com>)

By means of the technological developments on lamination, different materials can be used as a veneer. For instance, an aluminum foil is used as a core layer in order to lighten and strengthen the structure of plywood, and also differentiated, printed or colorful surfaces are used as back and face layer in order to get more graphical effects. Moreover, an ultra thin electrical infrastructure can be integrated in the layered construction of plywood. The EL Plywood Desk shown in Figure 3.39, which combines the traditional material and electrical infrastructure in a furniture system, is a luminous and smart plywood surface that merges lighting with information access.

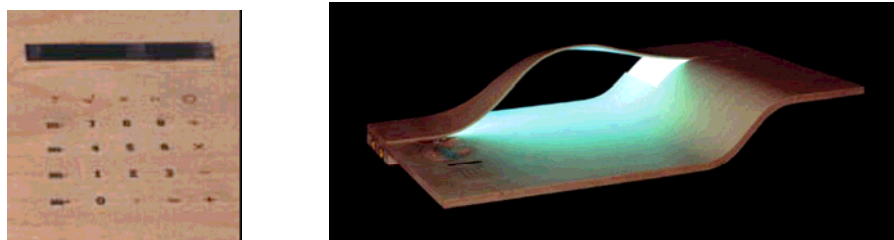

Figure 3.39: The EL Plywood Desk was designed by Sheila Kennedy, Supported by the U.S. Department of Energy, (<http://eere.energy.gov/buildings/documents/pdfs/>)

Consequently, plywood bridges the gap between technology and nature by reinforcing the link between high-tech human and the earth that has nurtured him. A great variety of plywood products in various sizes and organic shapes can be manufactured by bending.

**Plywood bending process** is a plastic state forming that can take place at a temperature close to 100°C (212°F) in the molding tools which assembled to a hot press or in a radio frequency press. There are two distinct methods to bent plywood, in such a way that, bending and adhesive bonding simultaneously or bending previously bonded flat plywood. Plywood, which is bent and bonded simultaneously, is more stable in curvature than previously bonded material.



Figure 3.40: Plywood bending process, (<http://www.ahwoddworks.com/bentwoodprocess.htm> )

In bending and bonding plywood in a single operation, adhesive-coated pieces of veneer are assembled and pressed between molding tools made up of aluminum or steel. Pressure and heat are applied by electrically heated or steamed forming dies in order to the adhesive sets and holds the veneers into the desired curvature. In the second method that is bending the plywood after bonding, flat plywood is bent by similar methods that is used to bent solid wood. In such a way that, flat plywood is thoroughly soaked in hot water, and then dried between heated forming dies attached to a hydraulic press. After being plasticized, the stock should be quickly placed in the bending apparatus and the piece of steamed wood is forced against the form.

In order to fix the bend, the piece should be cooled and dried. One method is to dry the piece in the bending machine between the plates of a hot-plate press. Another method is to secure the bent piece to the form and place both the piece and the form in a drying room. When the bent member has cooled and dried to moisture content suitable for its intended use, the restraining devices can be removed and the piece will hold its curved shape (Rowell, 1999).

### 3.3.3 Plastic Sheet Bending Process

One-axis straight line bending, also known as 'hot line bending' is best described as origami in thermoplastic rigid sheet material. Low tooling costs make it an ideal method for small quantity applications or prototypes. It is also cost effective for large volume requirements through the use of improved methods to blank out the part prior to bending.

Plastic based rigid sheet must be heated to make it pliable, and then it will become rigid again when it cools. So, it is said that the rigid plastic sheet is formed in a plastic state by hot line bending techniques. In this process, a strip heater is used to apply the heat at 155-167 °C (31- 332 °F) just to the area to be formed of a pre-cut plastic sheet. As manufacturing considerations, the sheets thicker than 3 mm should be heated on both sides for a proper bend and forcing the bend at lower temperatures will render the sheet fragile at the bend. By means of this heating process, it is produced a 'hot hinge' at the locally heated line that allows the sheet to be formed to the required shape.

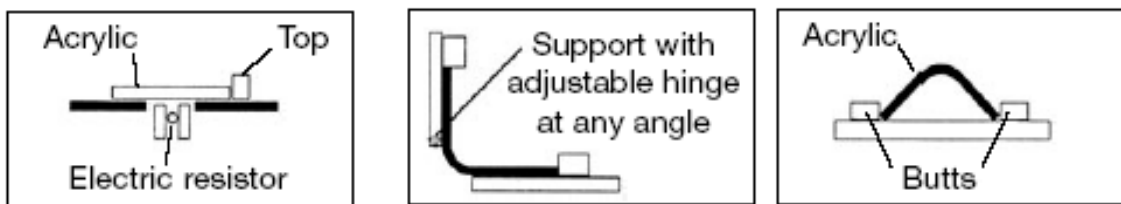

Figure 3.41: Hot line bending by manually, (<http://www.plastiglas.com.mx.pdf>, p. 27)

When the sheet has reached the required temperature the heaters are to be switched off. The sheet, held in pivoted clamps, preferably equipped with a caliper, is then bent to the required angle and secured there until it cools down and sets (see Figure 3.42). A jig is used to support the formed plastic sheet while it cools (see Figure 3.41)

Cooling following bending is to be done in ambient air, taking care to avoid sudden drafts. These can cause distortion of the final product. After forming, the part is cooled to below 140F to 160F.

As a thumb of rule, the minimal hot-line bending radius is 3 times the thickness of the bent sheet. Bevels with a relatively small radius are possible by notching the interior side. Larger radii can be achieved by widening the heated zone.

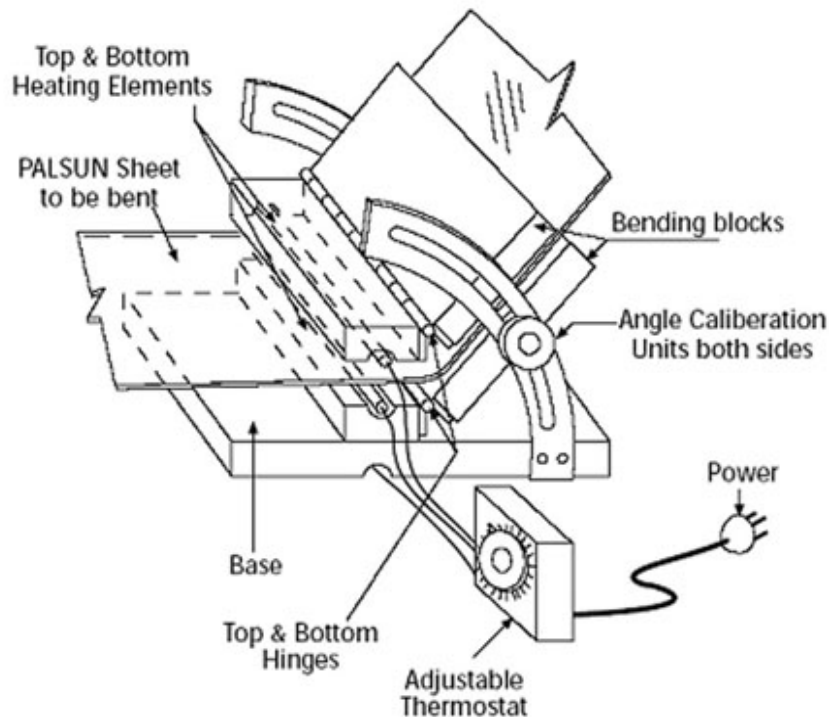

Figure 3.42: Hot line bending with bending machine, (www.plastiglas.com.mx.pdf, p. 26)

The line that will be scored on the polypropylene sheets are formed by the techniques known as ‘hot stamping’, which is similar to scoring of paper or cardboard (see Section 3.3.4). The stamping process of polypropylene sheets does not require heated material, but heated tools for working temperatures at 100-130°C (212-266°F). (Palsun technical manual, 2004, pp. 23-26)

### 3.3.4 Paper Sheet Folding Process

Scoring prior to folding reduces the stress ness that folding puts on paper, it may be scored before being folded. Scoring also helps to reduce the risk of crocking, and for some types of board scoring is even necessary to create a clean, well-defined fold. While three or several types of scoring devices, all work on a common principle. In such a way, a rounded rule pressing the paper into a channel. The width of the rule and channel will depend on the thickness of the paper. There is a thump of rule that the rule should never be thinner than the paper.

Scoring should be considered if a job requires multiple folds, if a thick paper or any types of board are used. Because if the weight of the paper increases so does its tendency to crack.

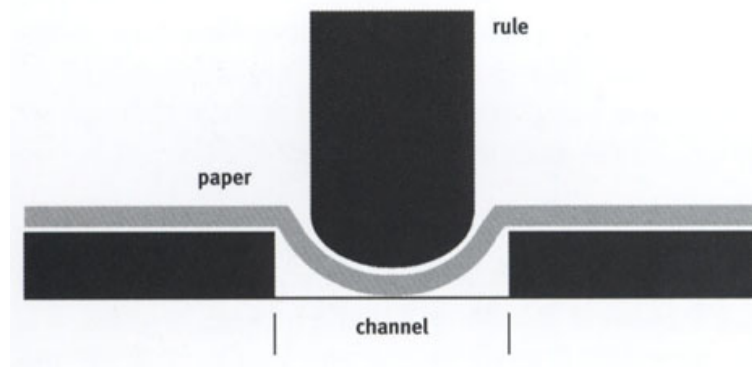

Figure 3.43: The principle of scoring, (Withers, 2002, p. 10).

## Folding

Standard folding machines can make four separate folds in one go. Furthermore, with additional folding machine extensions, the number of folds that can be completed automatically is considerable. In addition, there are folding machines that can score, perforate and glue at the same time as they fold. A successful fold is determined in two ways; fold quality and fold strength. The quality of the fold refers to its appearance, while the strength is measured by how many times a piece of paper can be folded back and forth before breaking.

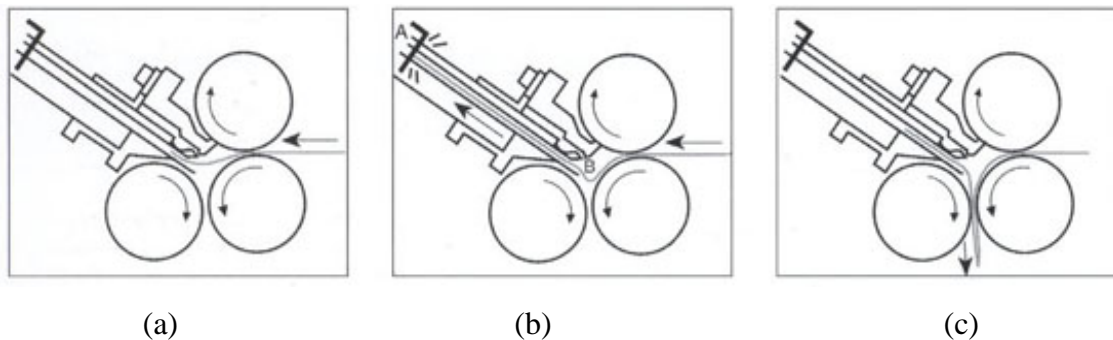

Figure 3.44: Working principle of 'Buckler' Folding Machine, (Withers, 2002, p. 8)

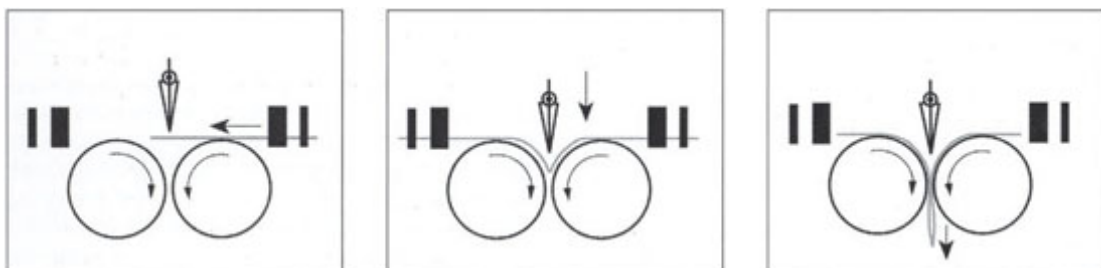

Figure 3.45: Working principle of 'Knife' Folding Machine, (Withers, 2002, p. 8)

In 'Buckler' folding machine, paper travels through the machine and then hits the deflector so begins to buckle, and then the paper is caught in the rollers and is pulled through, thus creating the fold.

In 'Knife' folding machine, paper travels through the machine and the knife comes down at a precise moment and hits the paper, so buckling it. The paper is then caught in the rollers and is pulled through, thus creating the fold (Withers, 2002, pp. 6-10).

## CHAPTER 4

### CASE STUDIES

In this chapter, it is purposed to attain a synthesis by considering the analysis in previous chapters, which are on origami design and origamic structured industrial products. With this intention, the industrial products designed by my own throughout my industrial design education have been discussed in detail in order to throw light on how these products were structured by considering origami design.

“Every form described in two ways: from the point of view of what it is, and from the point of view of what it does. What it is sometimes called the formal description. What it does, when it is put in contact with other things, is sometimes called the functional description” (Alexander, 1964, p. 89).

By regarding this quoting from influential design methodologist C. Alexander, the products have been described as either formal or functional in order to evaluate the appropriateness of their forms and contexts.

All the product proposals have been designed to solve the certain problems defined in below by considering the unity, modularity, and simplicity concepts. The forms of all of them have been constituted by using symmetry, isometry and repetition principles that had been discussed in Chapter Two. Furthermore, all the proposals have been made from sheet materials and formed by considering one-axis bending process that had been discussed in Chapter Three.

#### 4.1 Base



Figure 4.1: Product Proposal 1: Base

#### 4.1.1 Problem Definition

Either in waiting rooms and cafés or in homes, all of us prefer to take a glance at magazines with accompaniment of a cup of coffee. So, there is a certain need to arrange the magazines and is a necessity of a surface to put the cup on it. Base has been designed by considering this scenario, and thus it meets both two needs synchronously by means of its simple piece construction. In such a way, the eight lateral surfaces, which are the bases of the table actually, flow down from the four table surfaces and are functioning as a magazine holder.

#### 4.1.2 Formal Description of Base

Base is an origamic structured low coffee table that have been planned to be made from 1,5 mm sheet steel and to be formed by sheet metal bending process (see Section 3.4.1). By means of preferring two-sided colored sheet steel, it have been added great graphical effect to its strictly geometric form. The form structuring phases of Base is discussed in below.

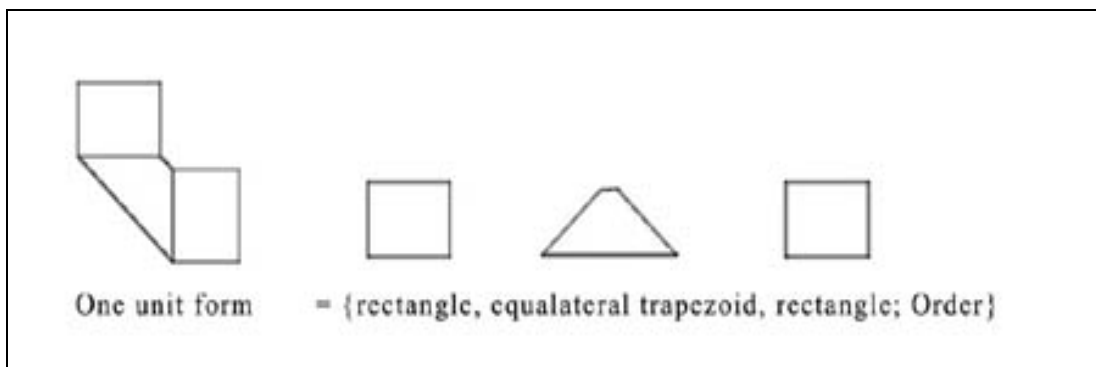

Figure 4.2: 'One unit form' Of Base that will be repeated

One unit form of Base's pattern has been constituted by ordering two rectangles and an equilateral trapezoid. So it can be said that, Base's pattern is a semi-regular tessellation (see section 2.44). In order to constitute the tessellation, Base's unit form was repeated by using mirror symmetry (see Figure2.10) twice. The semi-finished pattern shown in Figure 4.3.b is obtained by mirroring the unit form at symmetry axis 1, and then the pattern was completed with the second mirroring of the



semi-finished pattern at symmetry axis 2. On the basis of the symmetry groups that were discussed in Section 2.3, it can be said that Base is labeled with the ‘cm’ symmetry group (see. Figure 2.14).

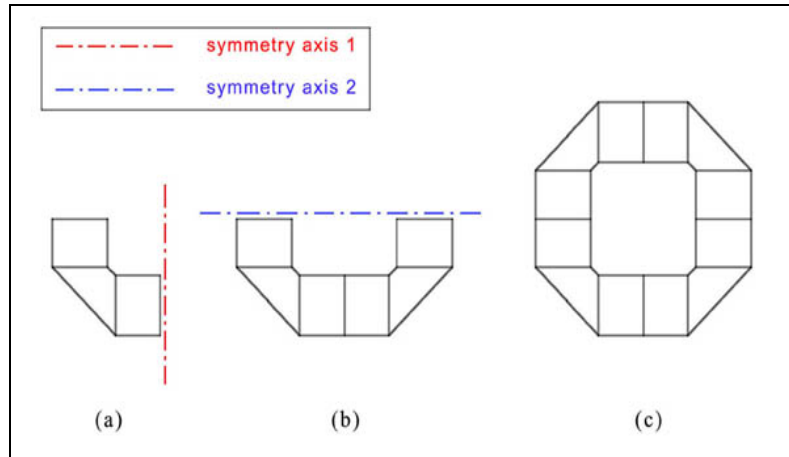

Figure 4.3: Constituting the pattern by considering symmetry principle

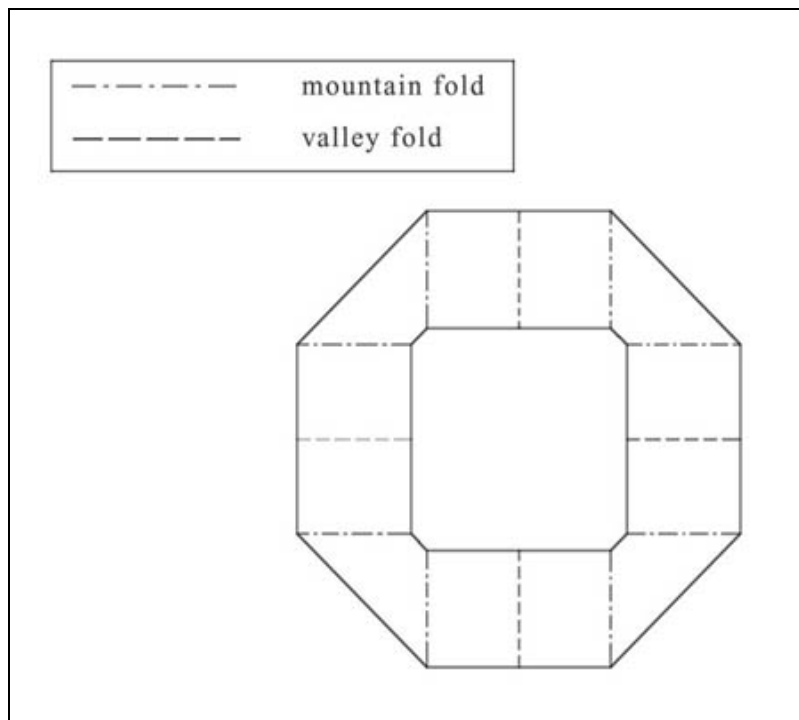

Figure 4.4: Crease pattern of Base

The crease pattern of Base shown in Figure 4.4 was determined in order to clarify how to fold each vertex. Base has been formed by considering this combination of ‘valley’ and ‘mountain’ folds (see Section 2.4.1). The four bases of

Base have been formed by the valley folds illustrated with the dotted lines. This creased pattern had been used to determine the bending sequence.

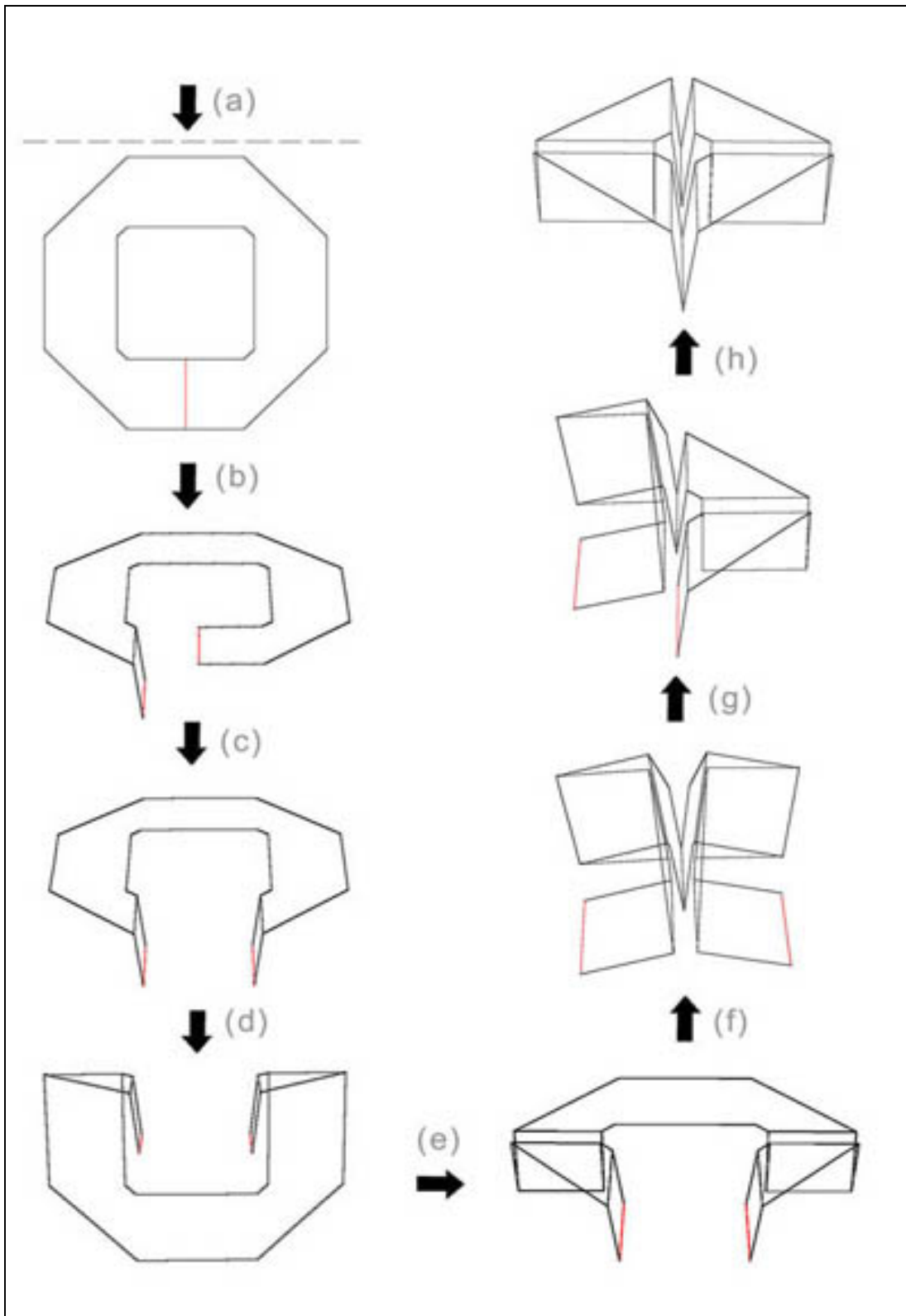

Figure 4.5: Bending Sequence Of Base

The certain shape of 'blank' (see Section 3.3.1.2) has been designed by considering 'the large inner cutouts' (see Section 3.3.1.1). In figure illustrated above, 'a' represents the flat processing and the line illustrated in red color represent the slitting (see Figure 3.31); 'b', 'c', 'd', 'g' and 'h' represents V-die bending process with 97 degree; 'e' and 'f' represents V-die bending process with 14 degree.

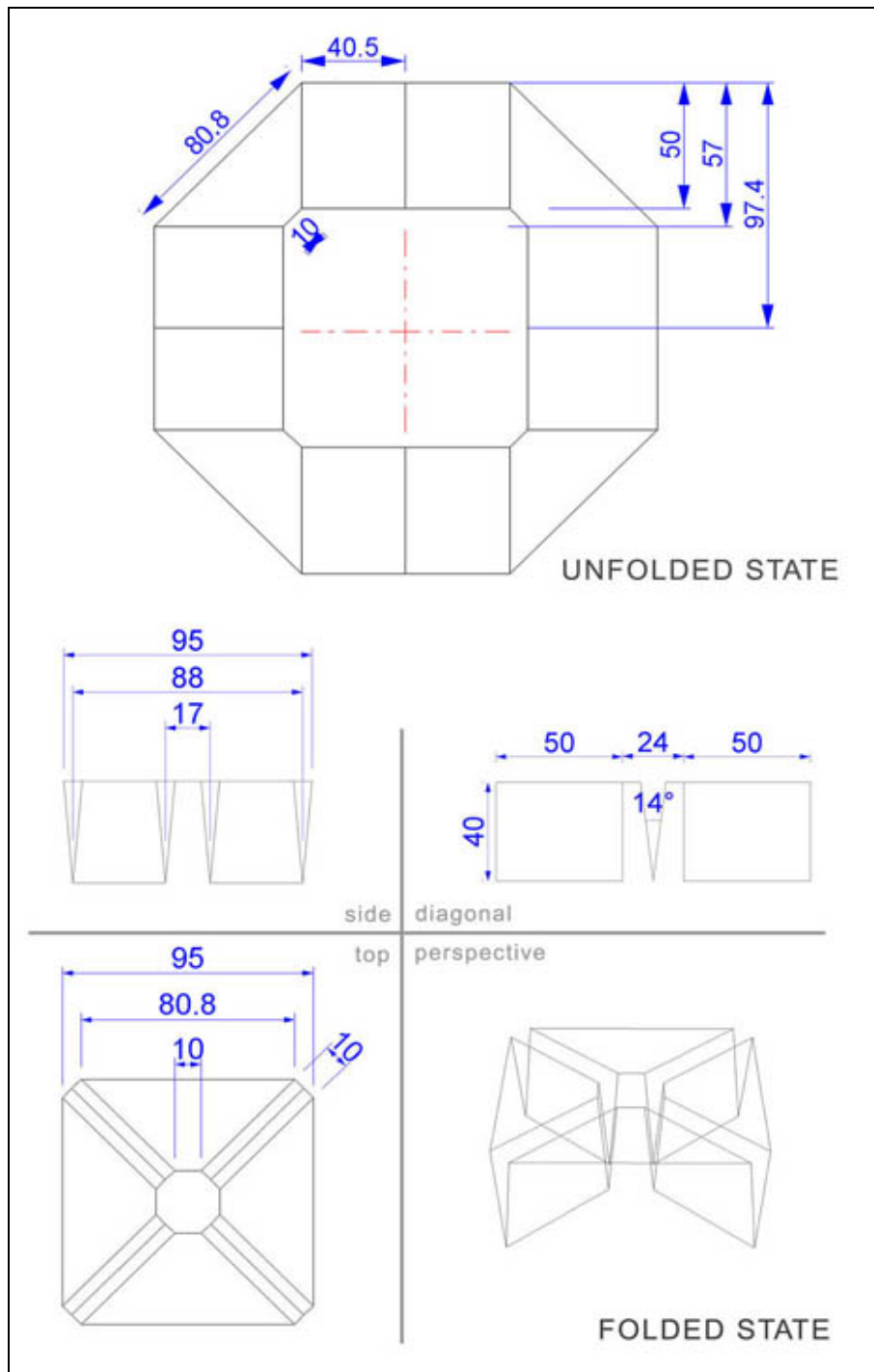

Figure 4.6: Technical Drawings Of Base (measures: mm, scale: 1/20)

### 4.1.3 Functional Description of Base



Figure 4.7: Magazine holder function of Base



Figure 4.8: Coffee table function of Base



Figure 4.9: Stockability

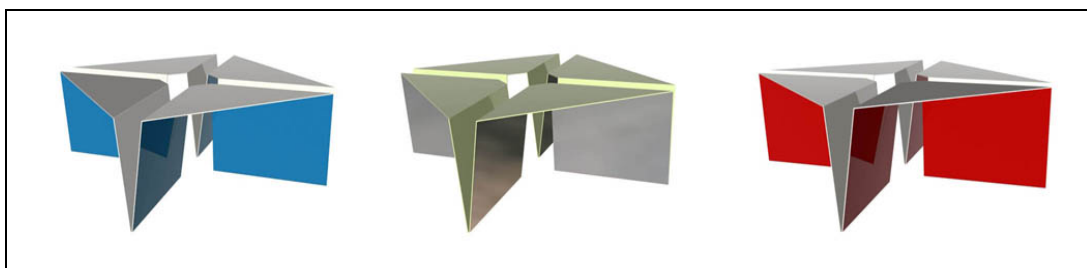

Figure 4.10: Graphical effect that adds emotional appeal

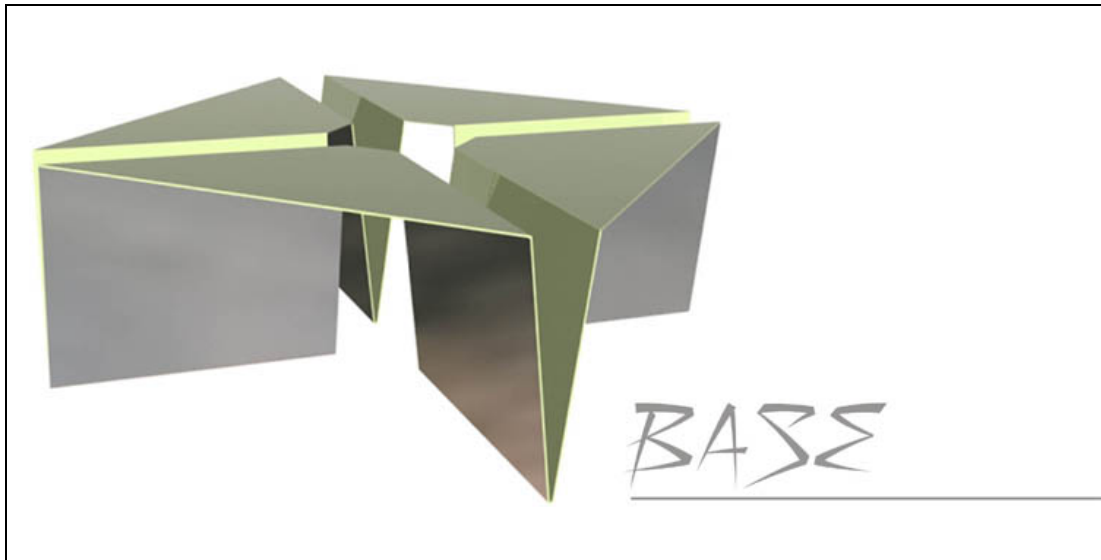

Figure 4.11: Perspective Preview 1 of Base

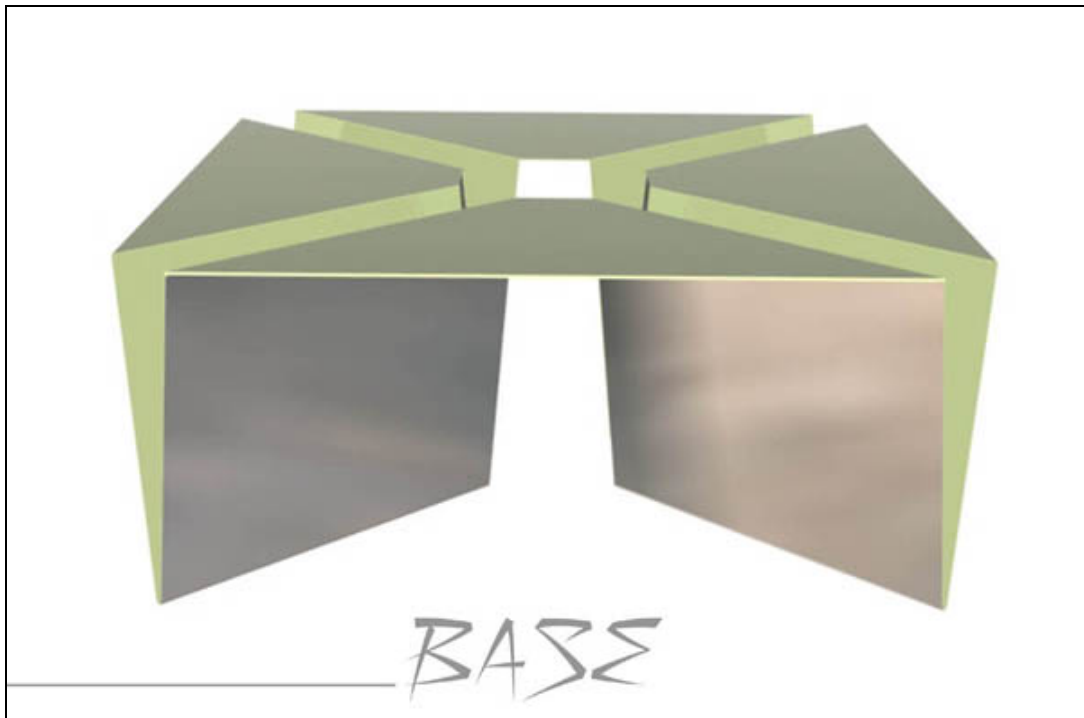

Figure 4.12: Perspective Preview 2 of Base

## 4.2 Pure



Figure 4.13: Product Proposal 2: Pure

### 4.2.1 Problem Definition

Pure has been designed to solve the ‘visual mess’ problem. Herein the term ‘visual mess’ has been used to define the untidiness that results from the ‘objects’ on the table surface. It has been indented to solve this problem in an unusual way by creating an area for stocking on the surface of the Pure. In such a way that, when four units of Pure are brought together at the same point, a concave volume in 20 mm depth takes shape by means of its concave lateral surface bended with an obtuse angle. In the event of it is used as a single unit at the corner of the room, because of its two vertexes contact with the wall, it is also possible to obtain the concave stocking volume, but in a quarter. Consequently, Pure has been designed as a hobby table for adults, and also as a play table for their children or as a low table for who favors tidiness. By means of its simple structure, Pure causes to manufacturer to earn in manufacturing cost, and also it has ease of assembly and maintenance. Besides, it also wins in transporting cost by means of its impressive stockability. Moreover, its simple structure enables it to be mass-produced by automatic CNC press brake bending. Consequently, besides Pure satisfies the certain needs defined above, it is also solve the cost problem.

### 4.2.2 Formal Description Of Pure

Pure is an origamic structured table that have been planned to be made from 1,5 mm sheet steel and to be formed by press brake bending. One unit form of Pure

shown in Figure 4.14 has been based on a quarter of circle. Thus the completed form of Pure shown in Figure 4.14.b has been constitute by considering four fold symmetry (see Figure 2.11.c).

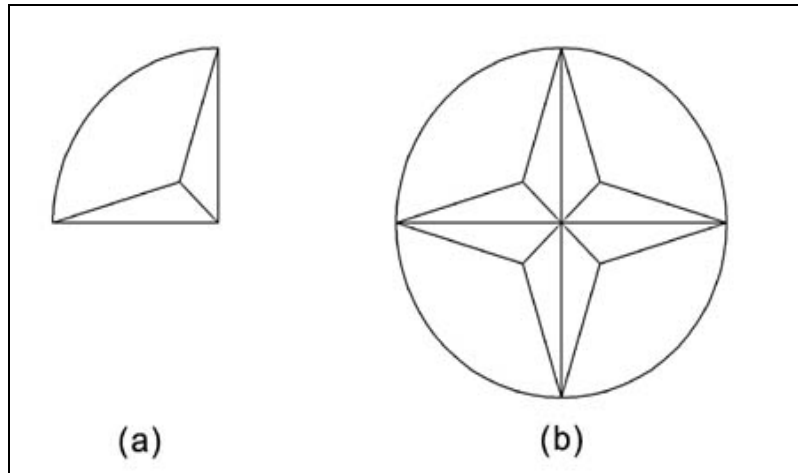

(a) One Unit Form

(b) Four Unit Forms

Figure 4.14: Unit Forms of Pure

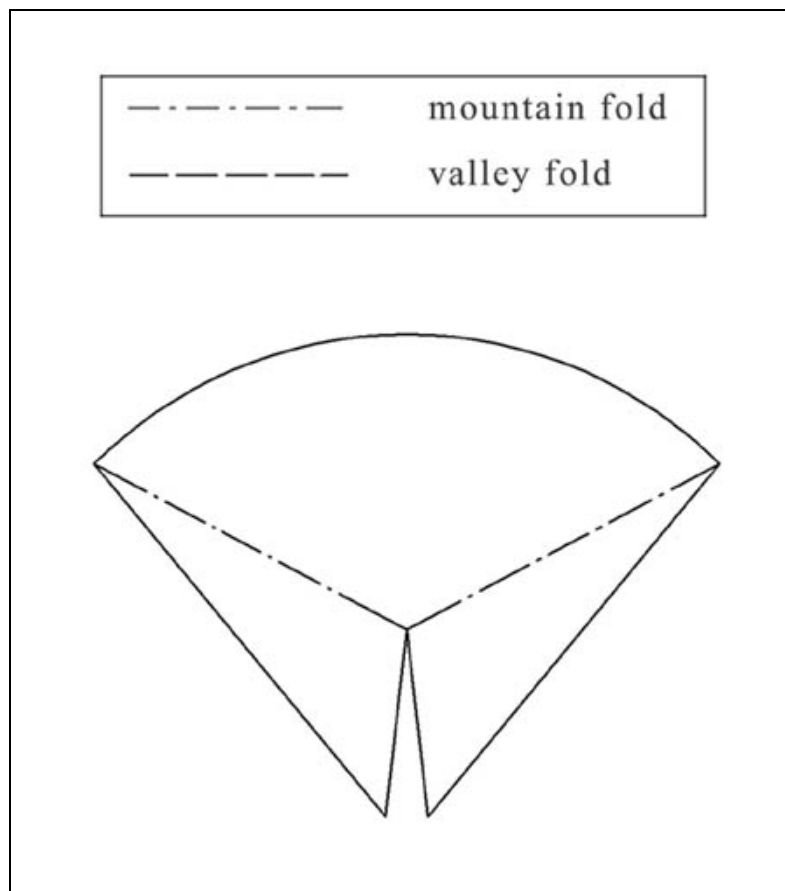

Figure 4.15: Crease pattern of Pure

Crease pattern of Pure consists of two mountain folds. This means that its manufacturing process by press brake bending consists of only two operations that follows laser cutting.

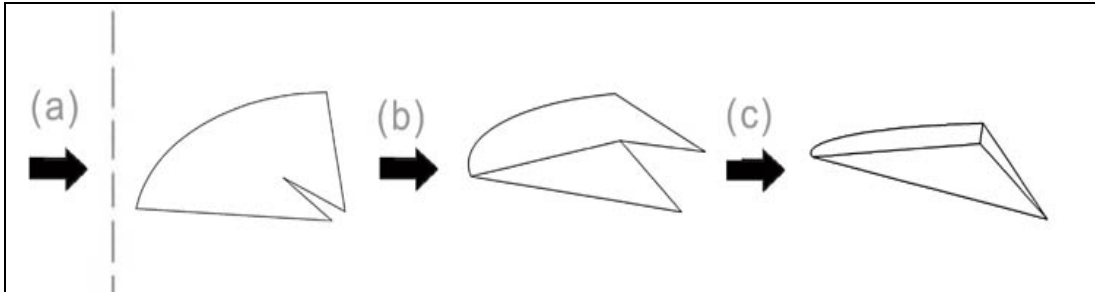

Figure 4.16: Bending sequence of Pure

In figure illustrated above, 'a' represents the flat processing. 'b' and 'c' represents V-die bending process (see Section 3.3.1.3) with 160 degree. Because of both two simple bends can be achieved with same tooling, Pure also causes to manufacturer to earn in setting or adjustment costs.

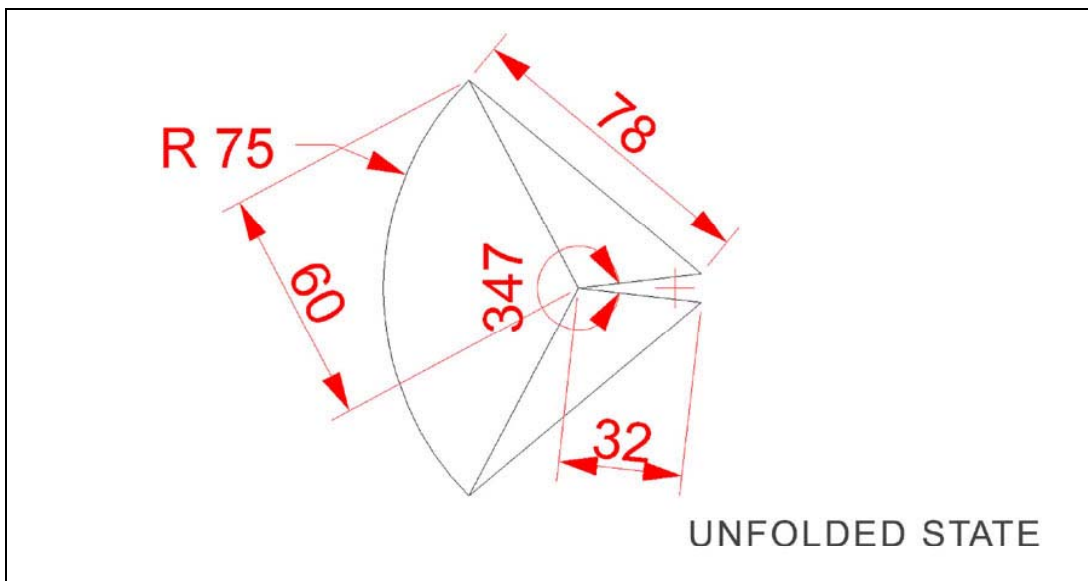

Figure 4.17: Technical drawings of one unit Pure in unfolded state (measures: mm, scale: 1/20)



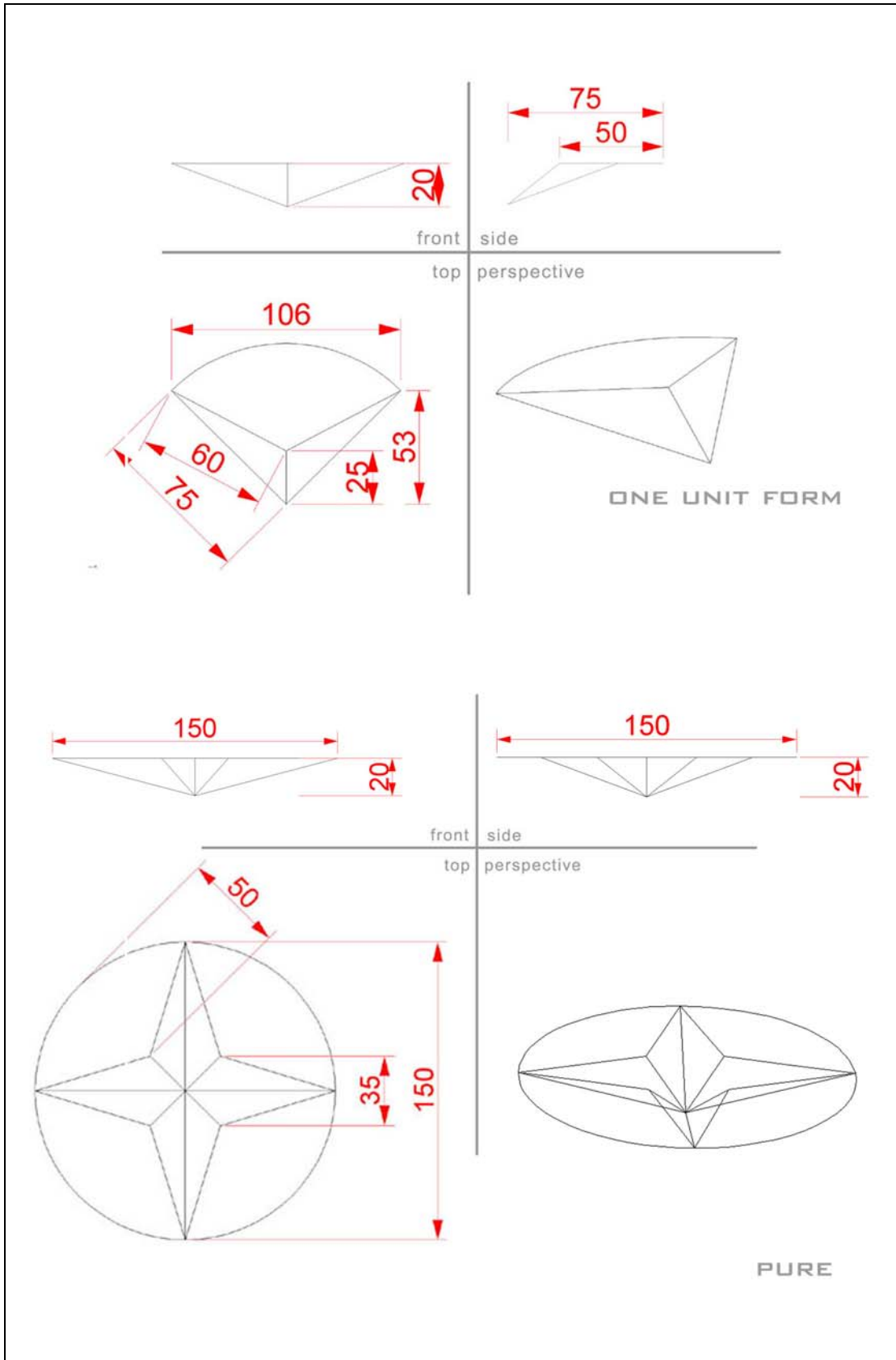

Figure 4.18: Technical Drawings Of Pure in folded state (measures: mm, scale: 1/20)

### 4.2.3 Functional Description of Pure

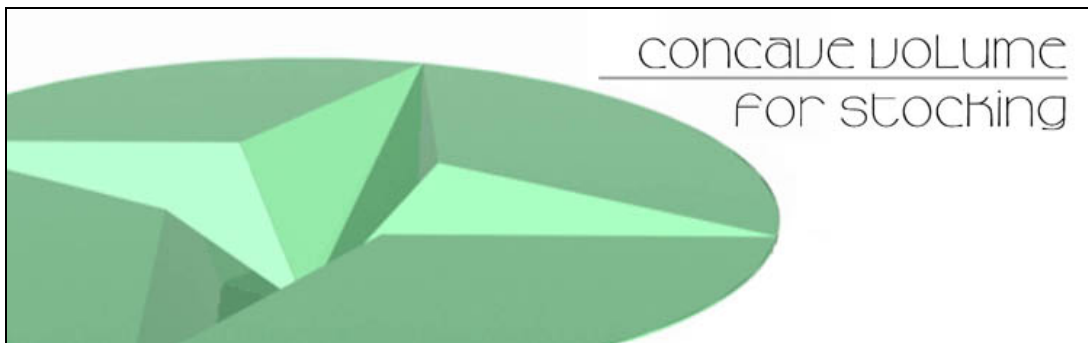

Figure 4.19: Stocking Function



Figure 4.20: Low table function



Figure 4.21: Stockability

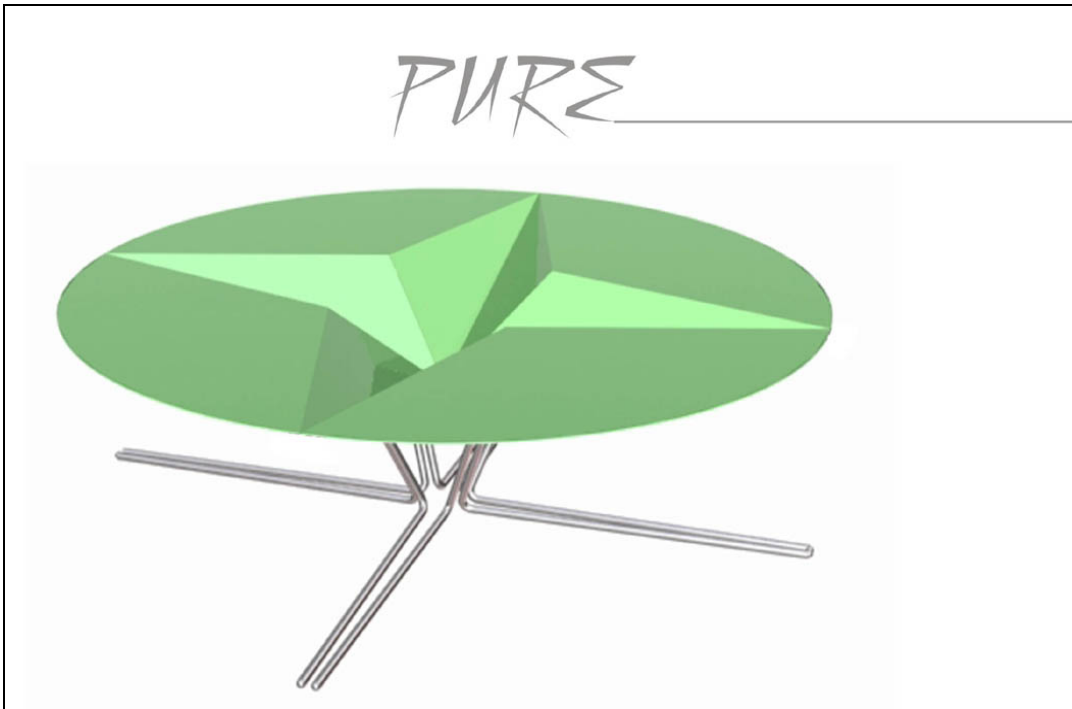

Figure 4.22: Perspective Preview 1 of Pure

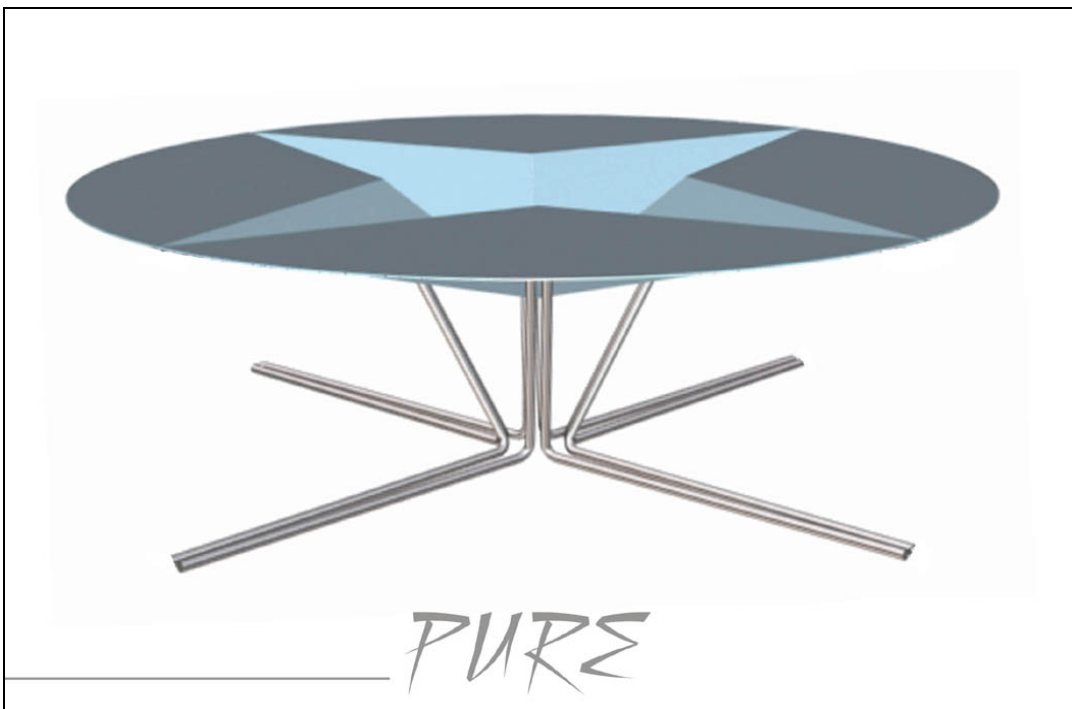

Figure 4.23: Perspective Preview 2 of Pure

## 4.3 Leaf



Figure 4.24: Product Proposal 3: Leaf

### 4.3.1 Problem Definition

Leaf is the result of analyzing the bare essentials of common working space, people and the objects within and proposes a synthesis of open office system solution. It intends to satisfy the staff by enabling the team working whereas creating a personal space at the same time. In such a way it uses the transition between objects to redefine the working space by unifying a desk surface and a storage system into a one plane. So, Leaf brings in an evolutionary solution for common working space by creating its own microenvironment. In other words, instead of merely supplementing the office landscape, Leaf innovates it.

### 4.3.2 Formal Description Of Leaf

One Leaf unit is structured by considering the ‘biomimetic folding patterns’ that had been discussed in detail in Section 2.5.1.2. It consists of a corrugated surface of alternating mountain and valley folds, meeting the midrib at an angle 60 degree. (see Figure 4.25.a).

The tripled pattern shown in Figure 4.25.b is obtained by applying the three-fold rotational symmetry (see Figure 2.11). This structure has a leaf-out pattern (see Figure 2.37.a), because it is directed away from the center of the polygon. The patterns shown in Figure 4.25.c, d, f, g are derived by considering isometries (see Figure 2.13). The pattern shown in Figure 4.25.e is constituted by repeating the pattern shown in Figure 4.25.d at the point ‘x’.

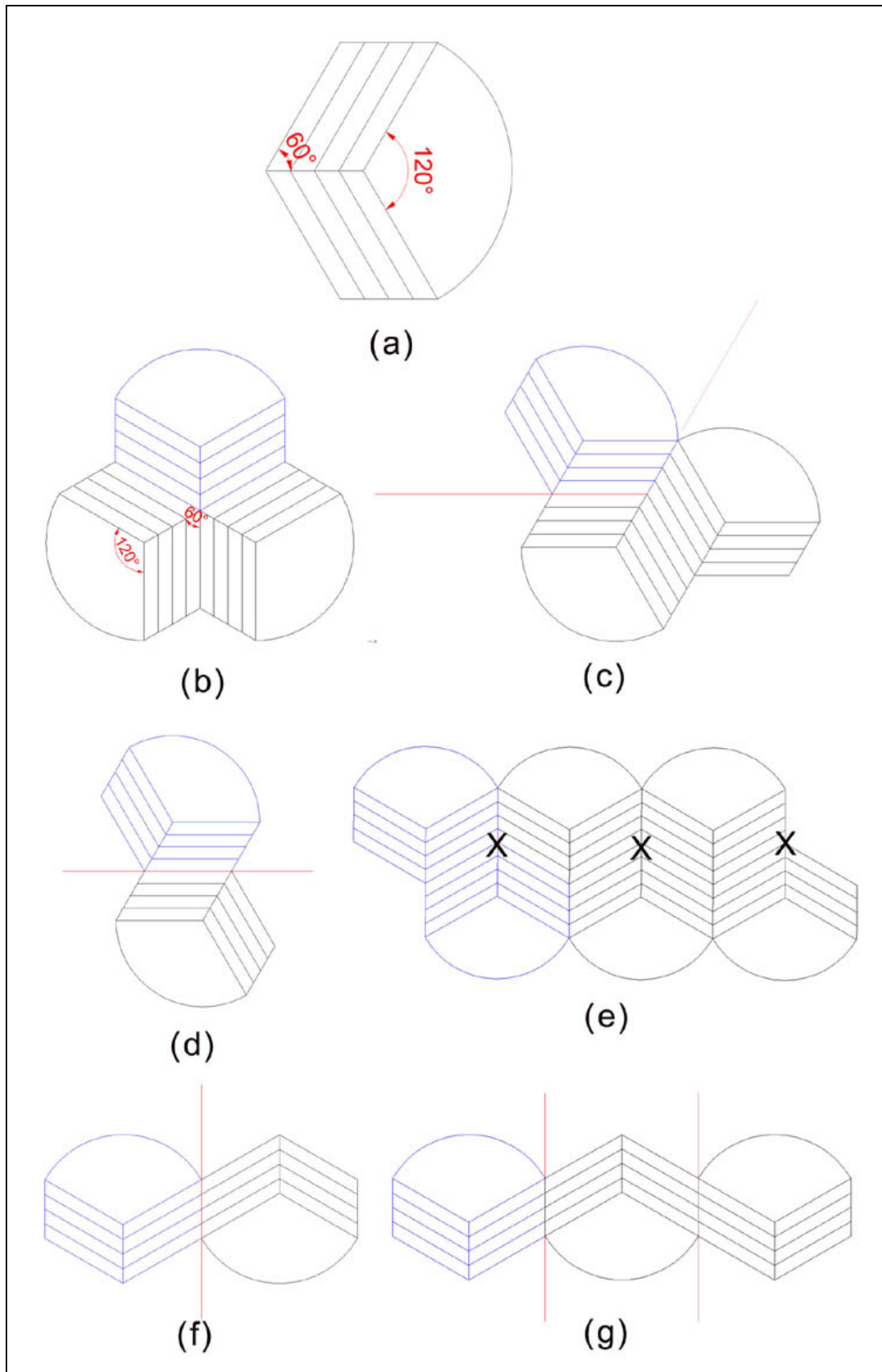

Figure 4.25: Patterns Constituted By One Leaf Unit

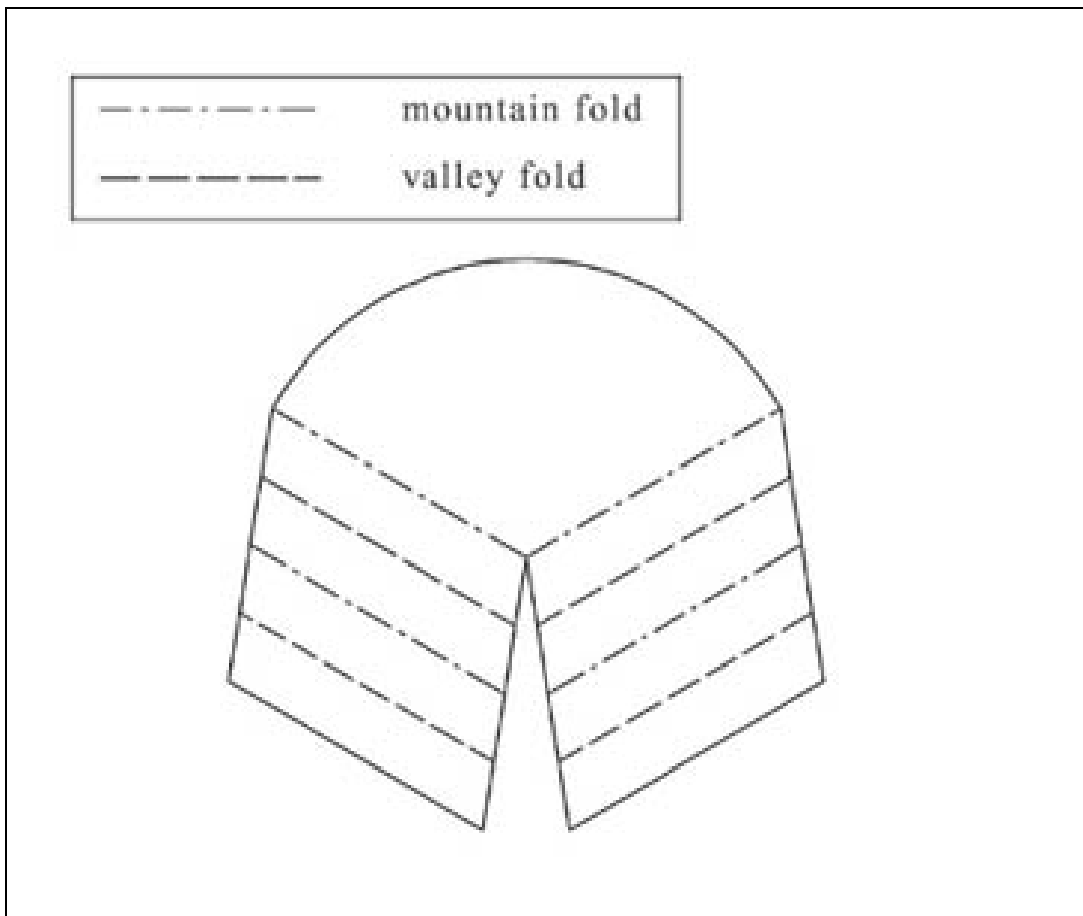

Figure 4.26: Crease pattern of one Leaf unit

The corrugated storage surfaces of Leaf are formed by alternating four mountain folds and four valley folds. The bending sequence of one unit leaf is determined by the crease pattern shown in Figure 4.26.

In Figure 4.27, (a) represents flat processing; (b) and (c) represents V-die bending at angle 135 ; (d), (e), (f), and (g) represents V-die bending at angle 90.

The lateral surfaces that flow down from the desk surface are bend with process (b) and (c ), and it separates the working space and storage space. Other corrugated lateral surfaces complete the storage system.

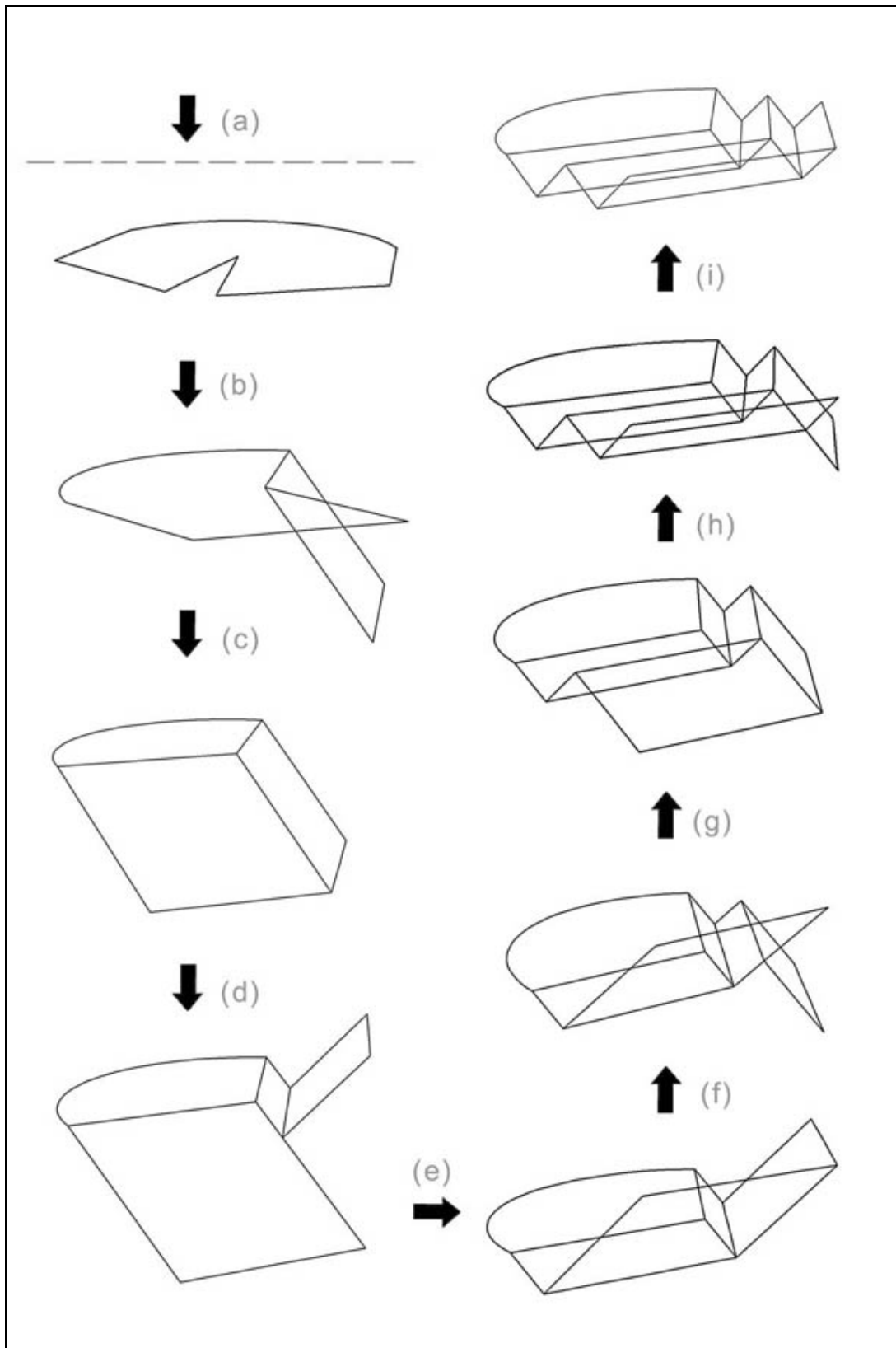

Figure 4.27: Bending Sequence Of One Leaf Unit

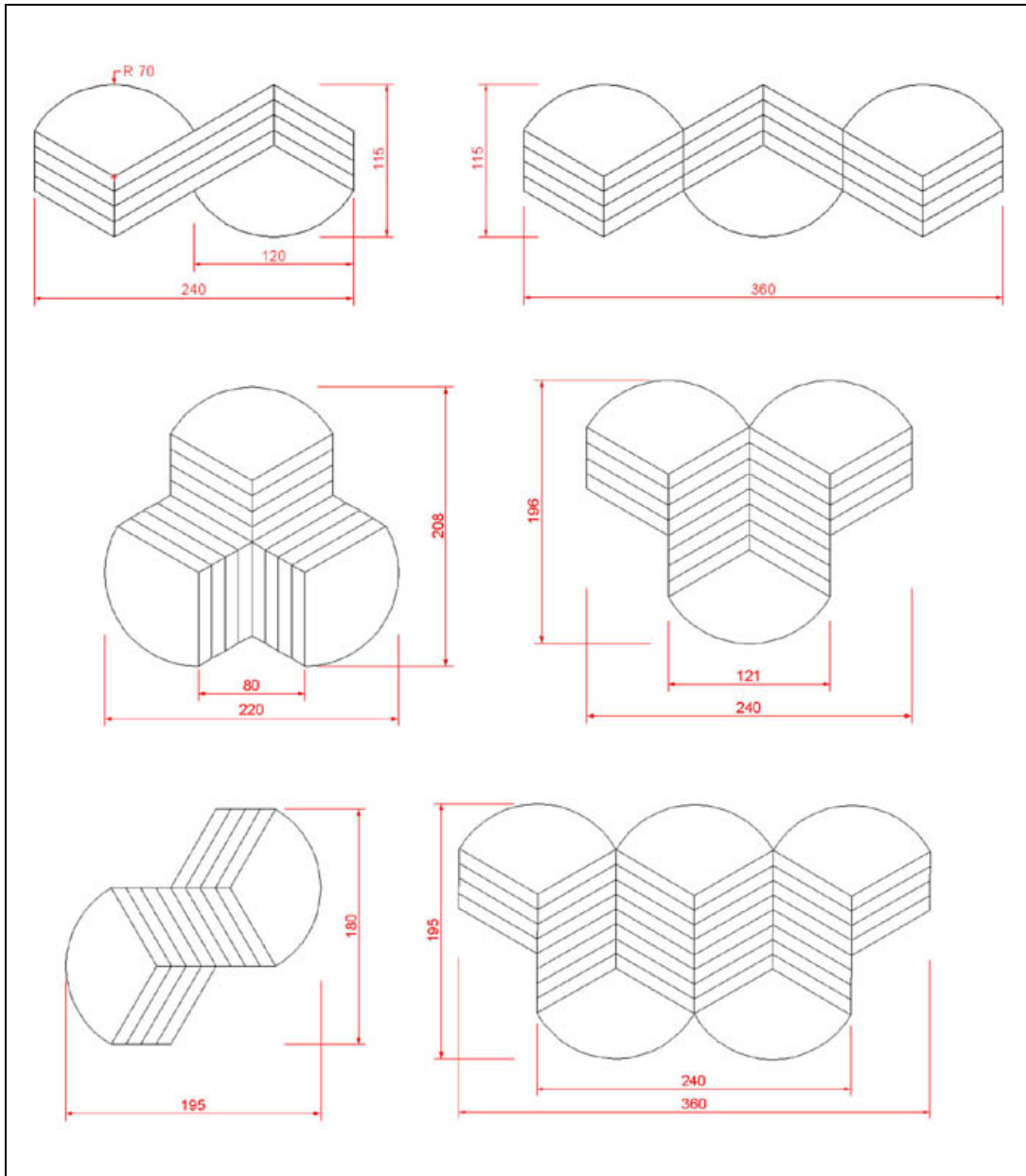

Figure 4.28: Technical Drawings of Patterns Constituted By One Leaf Unit



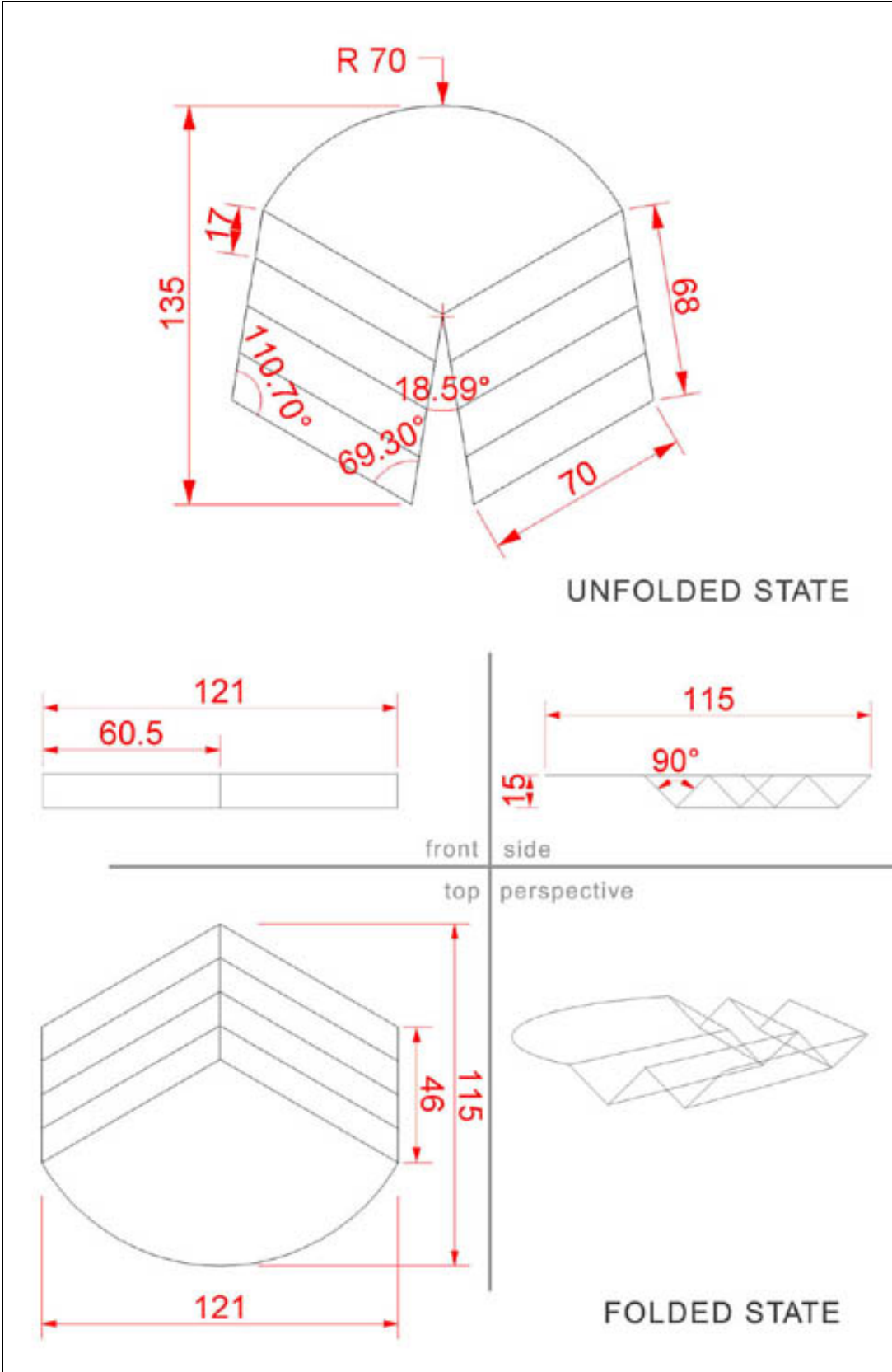

Figure 4.29: Technical Drawings Of one Leaf unit (measures: mm, scale: 1/20)

### 4.3.3 Functional Description Of Leaf



Figure 4.30: Stockability

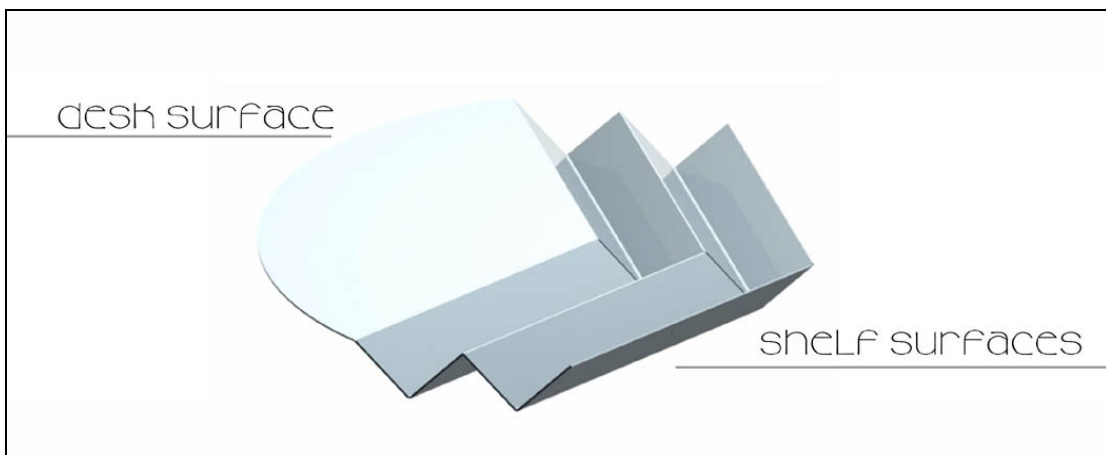

Figure 4.31: Multipurpose of Leaf unit



Figure 4.32: Perspective Previews of Three Leaf Units (first alternative)



Figure 4.33: Perspective Previews of Two Leaf Units (first alternative)



Figure 4.34: Perspective Previews of Two Leaf Units (second alternative)

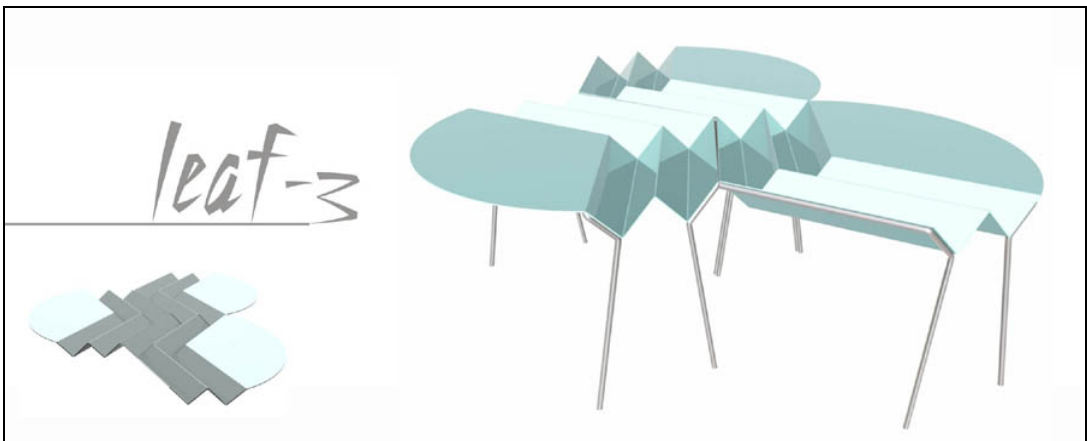

Figure 4.35: Perspective Previews of Three Leaf Units (second alternative)

## 4.4 TriOri



Figure 4.36: Product Proposal 4: TriOri

### 4.4.1 Problem Definition

TriOri has been designed by considering the ‘lack of space’ problem in schools and libraries. In these places, there are always needs to space for either individual studying, or team works. TriOri satisfies these both needs by means of its transformable single piece structure. In such a way, when it is erected, a polygonal separator surface occurs in the middle of the structure. And when it is deployed, the separator surface transform into a plane that has two times big surface area than it has erected state. Thus, the secondary planer surface in the middle of the structure enables an appropriate area for meeting.

Moreover, this origamic structured desk made from polypropylene sheet have been designed by considering the concept involves products that may be thoroughly finished by the client itself (by assembling, folding, etc.), which, on one hand saves the manufacturer a step in the process, and on the other sparks up the client’s attention towards the product.

### 4.4.2 Formal Description of TriOri

TriOri is a desk made from polypropylene sheet, pre-formed by scoring (see Section 3.3.4), and folded by the costumer. It has a strictly geometric form that can be well defined. As follows, its six bases and separator are defined as a tetrahedron (Figure 2.27.a), whereas the individual surface shape is equilateral trapezoid, and also

the meeting desk is a hexagonal. One unit form of TriOri is tripled by three-fold symmetry.

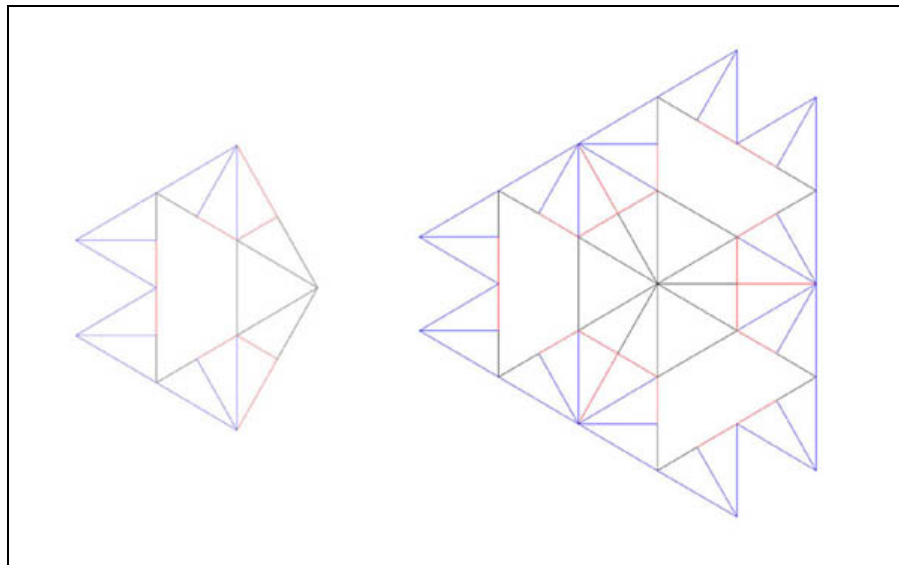

Figure 4.37: One Unit Form and Three Units Form of TriOri

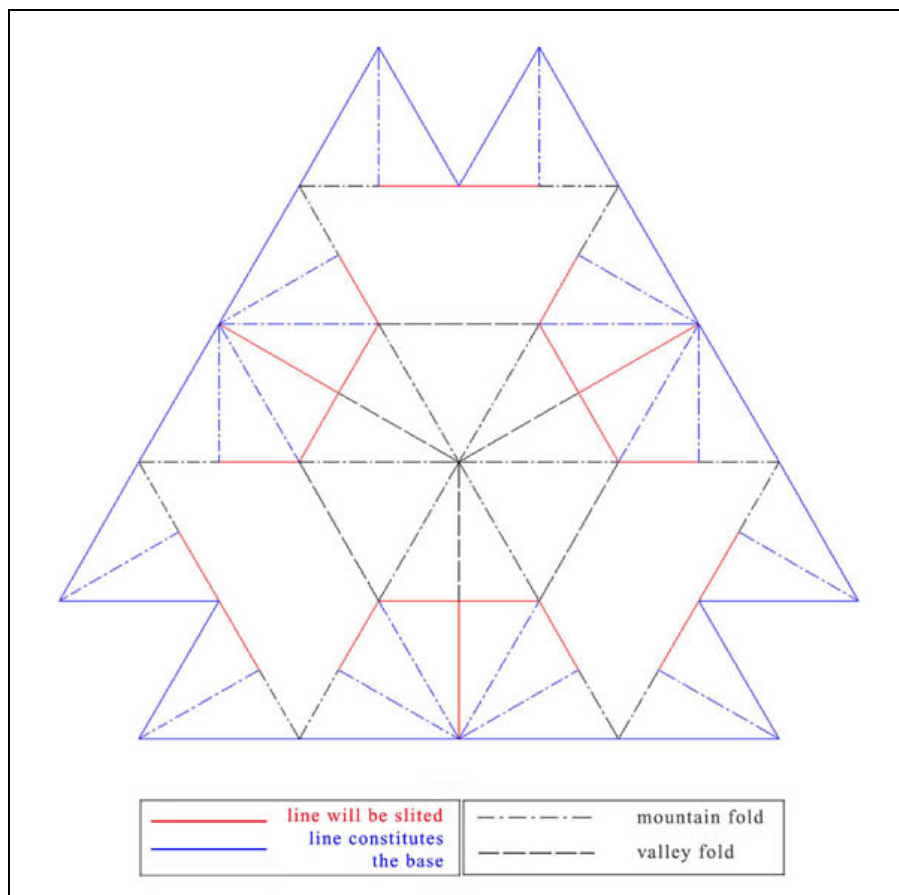

Figure 4.38: Crease pattern of TriOri

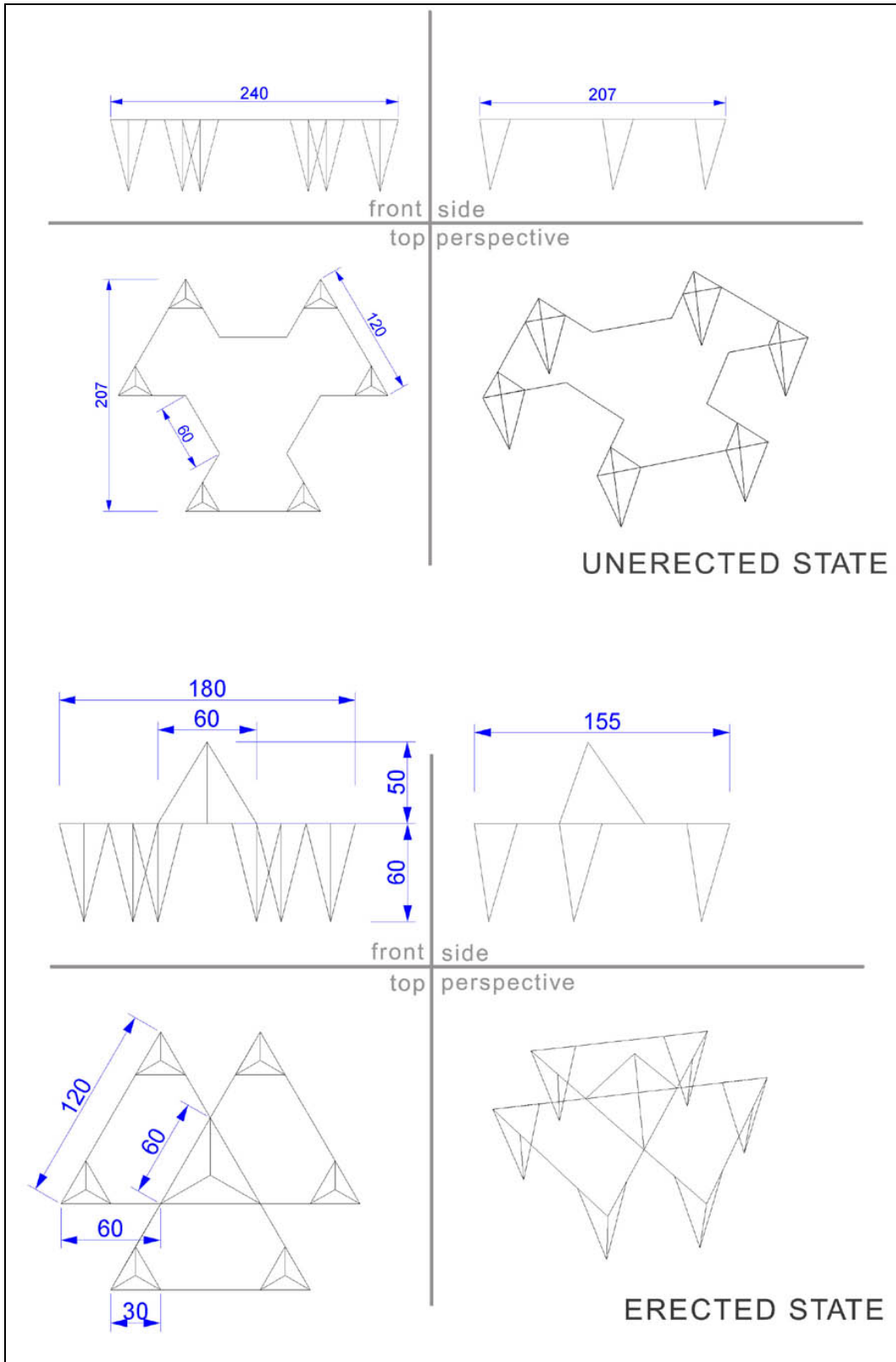

Figure 4.39: Technical Drawings Of TriOri (measures: mm, scale: 1/20)

### 4.4.3 Functional Description Of TriOri

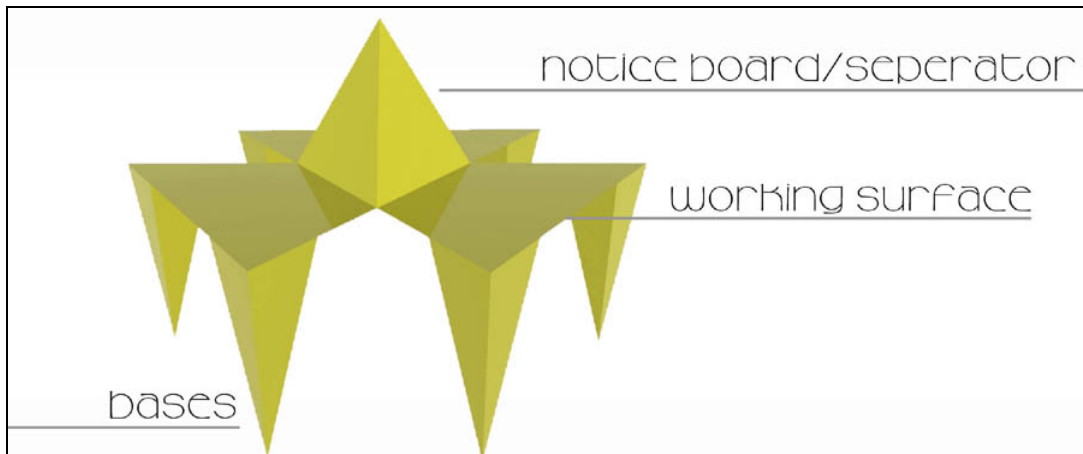

Figure 4.40: Multipurpose of TriOri in erected state

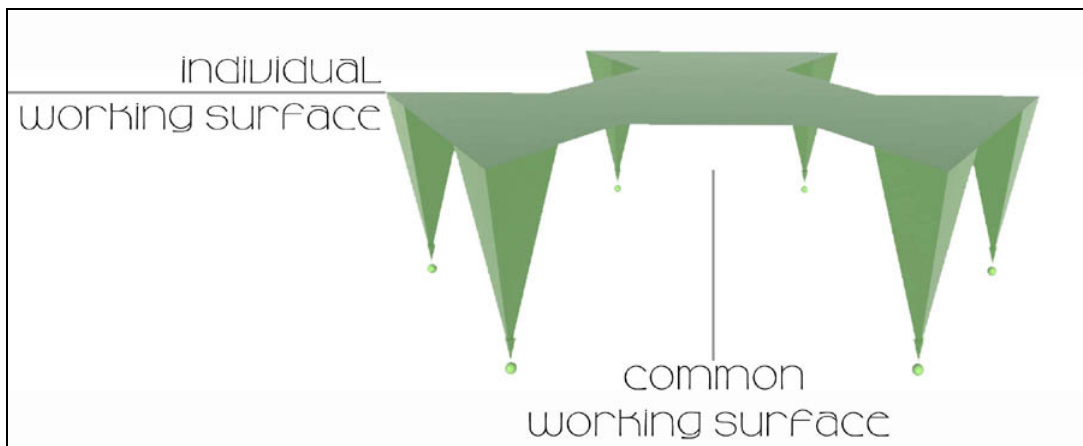

Figure 4.41: Multipurpose of TriOri in unerected state



Figure 4.42: Flat packaging of TriOri

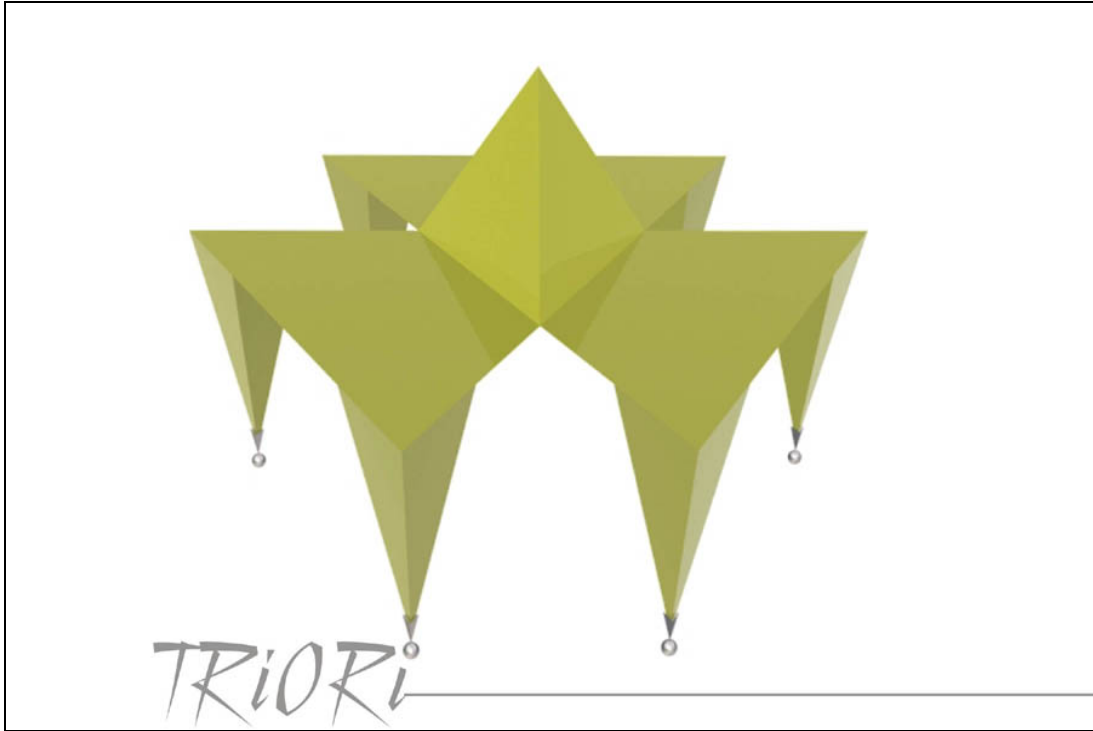

Figure 4.43: Perspective Preview 1 of TriOri

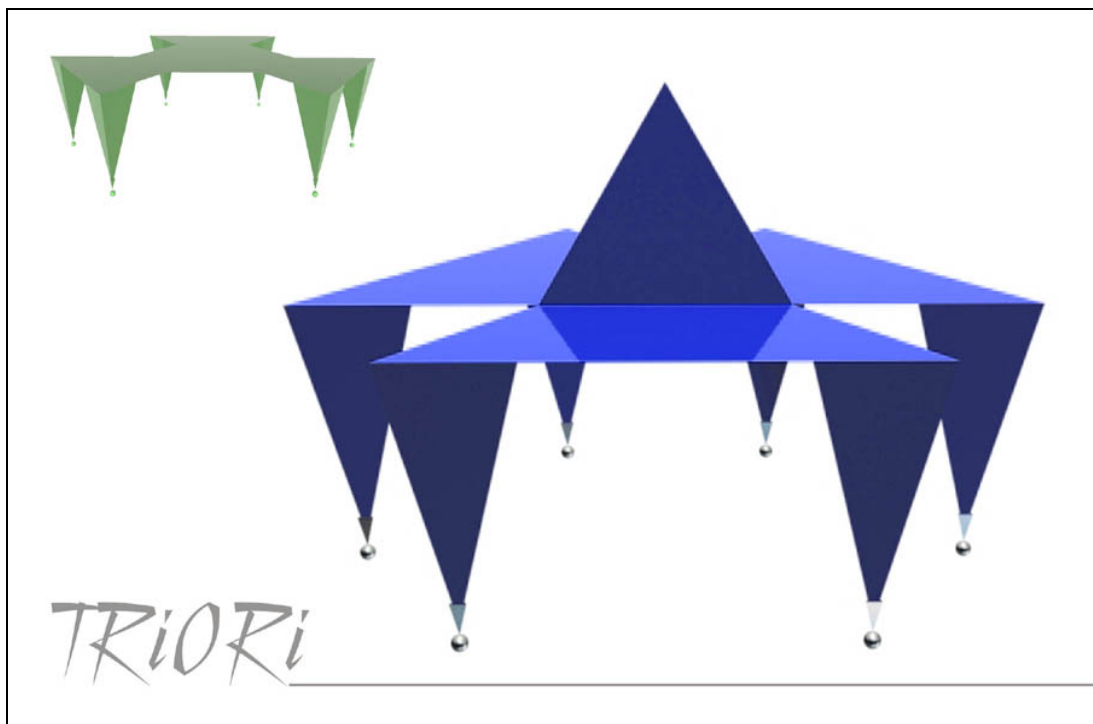

Figure 4.44: Perspective Preview 2 of TriOri



## 4.5 ModulOri

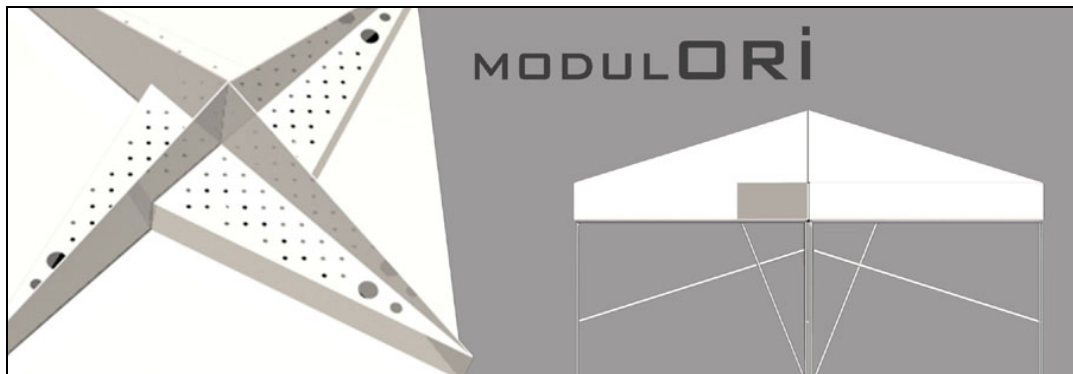

Figure 4.45: Product Proposal 5: ModulOri

### 4.5.1 Problem Definition

ModulOri is a working desk fabricated from sheet steel by bending process. The design adds to the strength of the material; and also the shape itself solves functional and structural issues. With its single piece construction and its continuous surface, the spaces for writing, shelving and separating spontaneously take shape. Tubular cd and dossier holder could be assembled to the small holes on the shelf surface. Pencil case and also a vase can be hanged for obtaining friendlier environment.

### 4.5.2 Formal Description of ModulOri

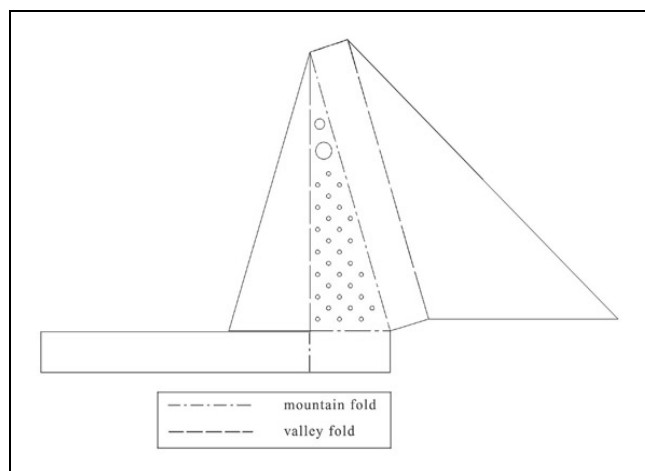

Figure 4.46: Crease Pattern Of ModulOri

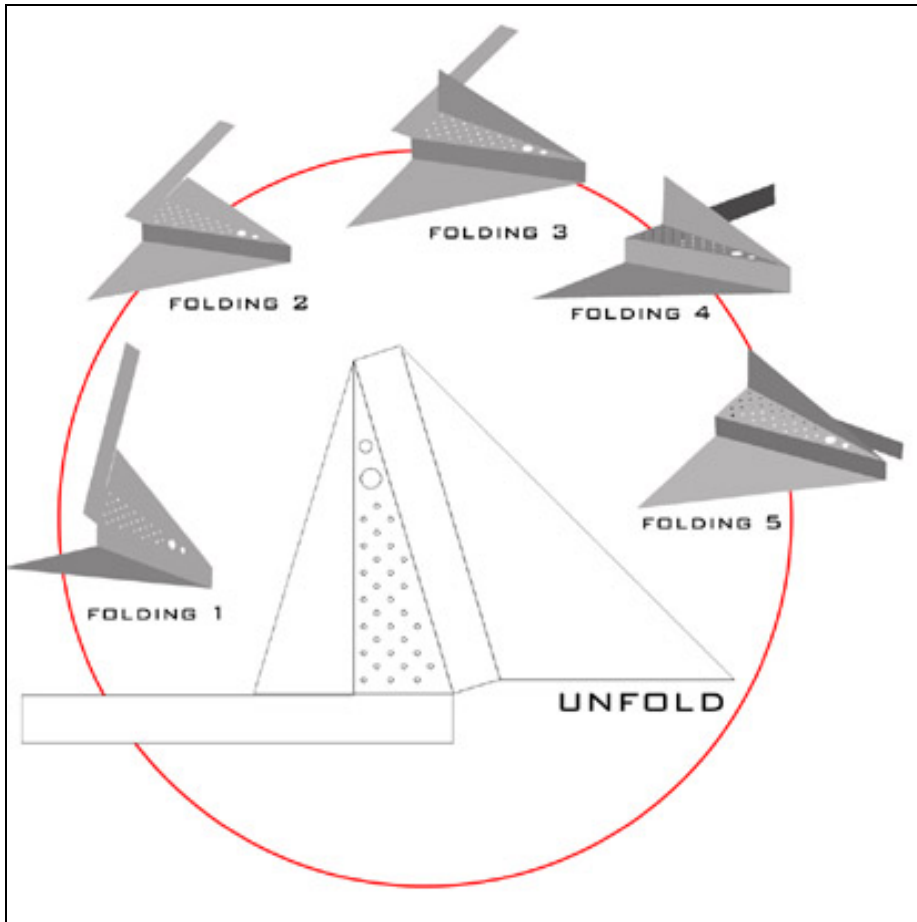

Figure 4.47: Bending sequence of ModulOri

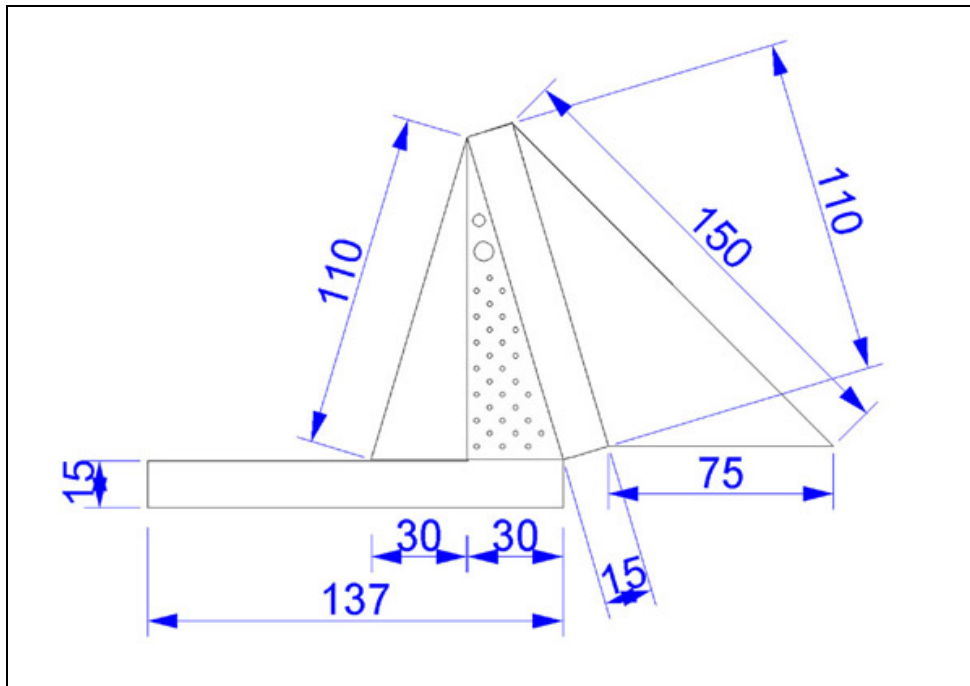

Figure 4.48: Technical Drawings of One unit ModulOri in unfolded state

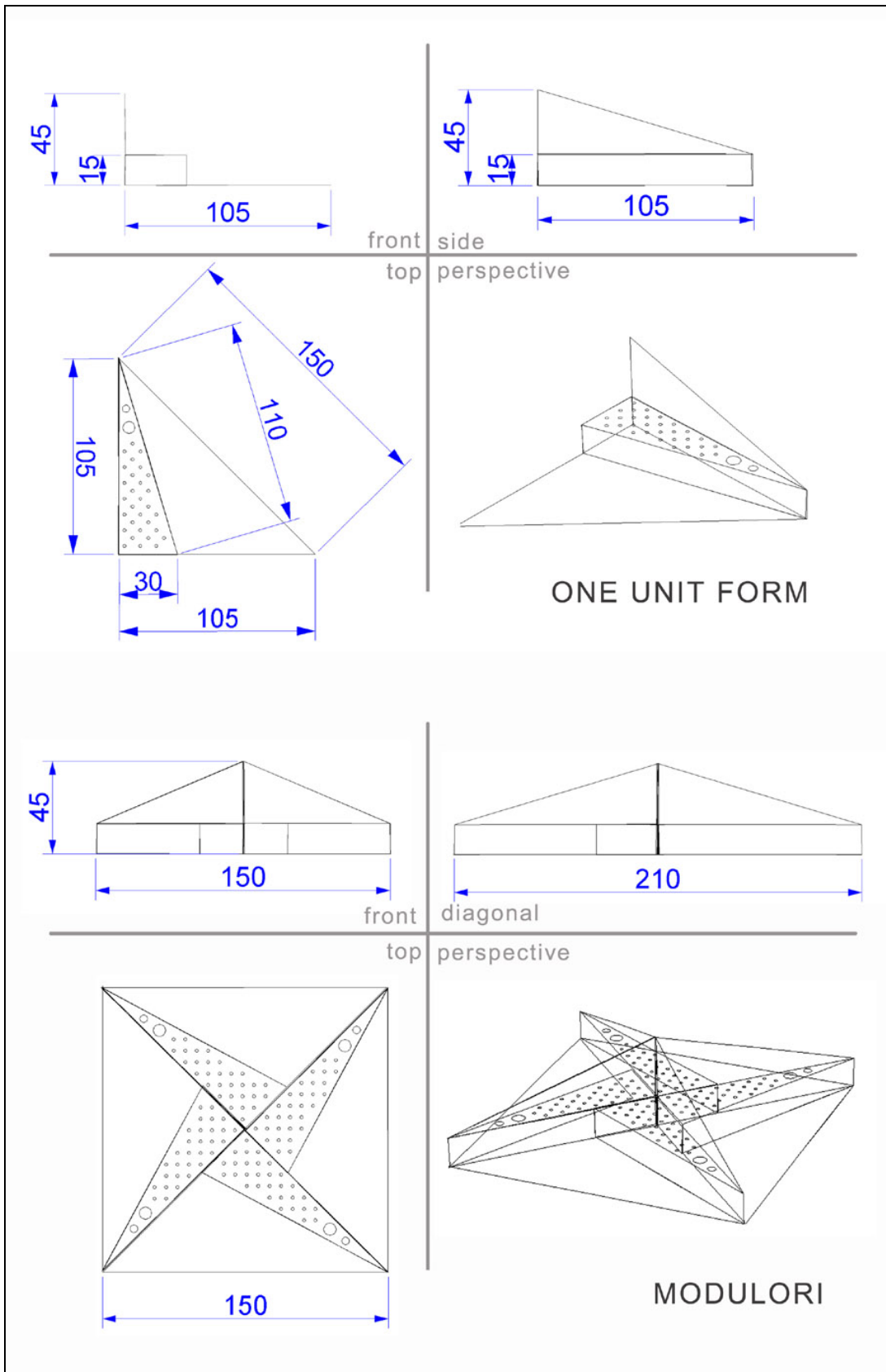

Figure 4.49: Technical Drawings Of ModulOri (measures: mm, scale: 1/20)

### 4.5.3 Functional Description of ModulOri

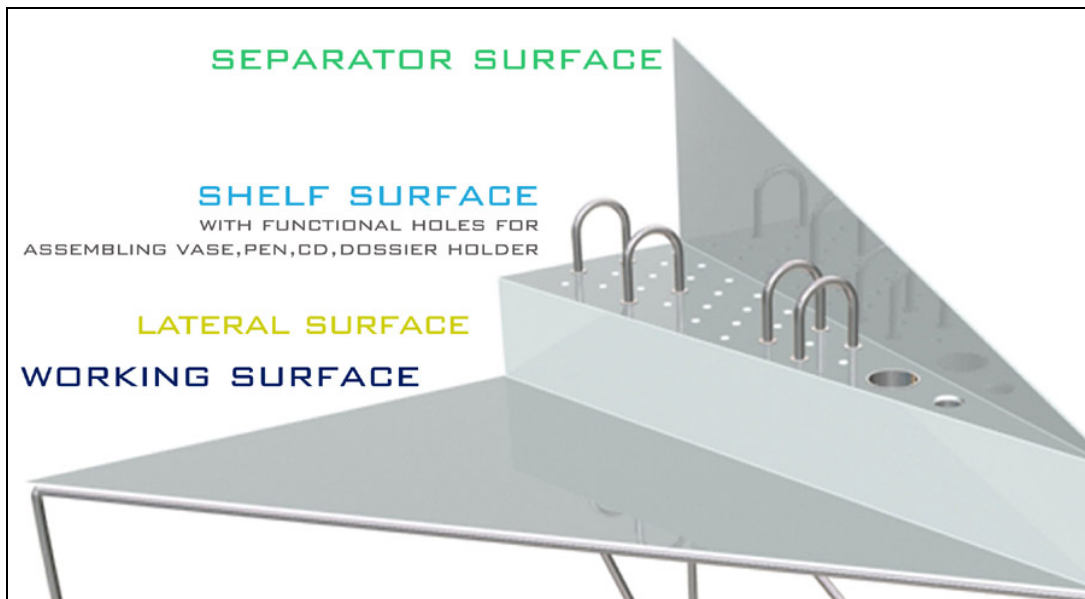

Figure 4.50: Multipurpose of ModulOri



Figure 4.51: Four Units Form Of ModulOri (first alternative)

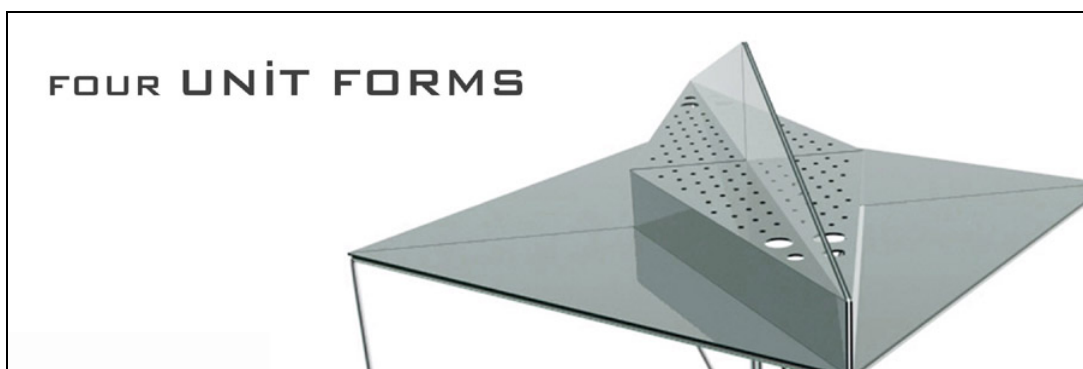

Figure 4.52: Four Units Form Of ModulOri (second alternative)

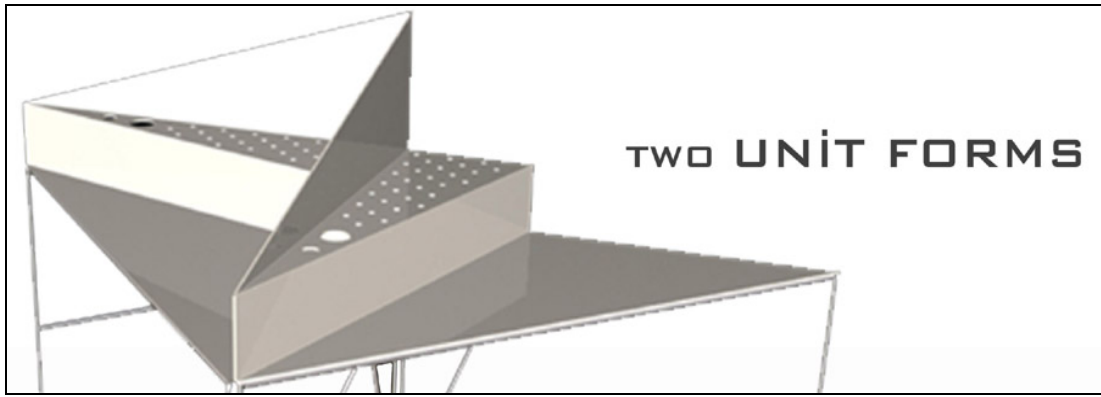

Figure 4.53: Two Units Form Of ModulOri (first alternative)



Figure 4.54: Two Units Form Of ModulOri (second alternative)



Figure 4.55: One Unit Form Of ModulOri

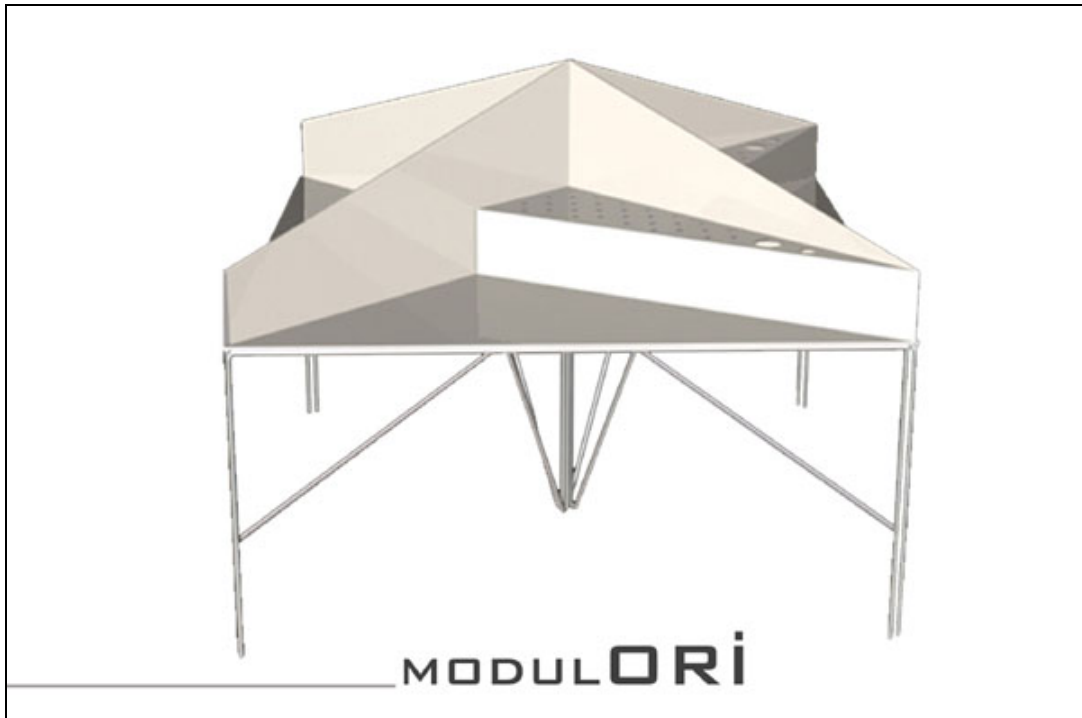

Figure 4.56: Perspective Previews of ModulOri

## 4.6 WindRose



Figure 4.57: Product Proposal 6: Windrose

### 4.6.1 Problem Definition

Windrose is a working desk fabricated from sheet steel by bending process. The design adds to the strength of the material; and also the shape itself solves functional and structural issues. With its single piece construction and its continuous surface, the spaces for writing, shelving and separating spontaneously take shape.

## 4.6.2 Formal Description of Windrose

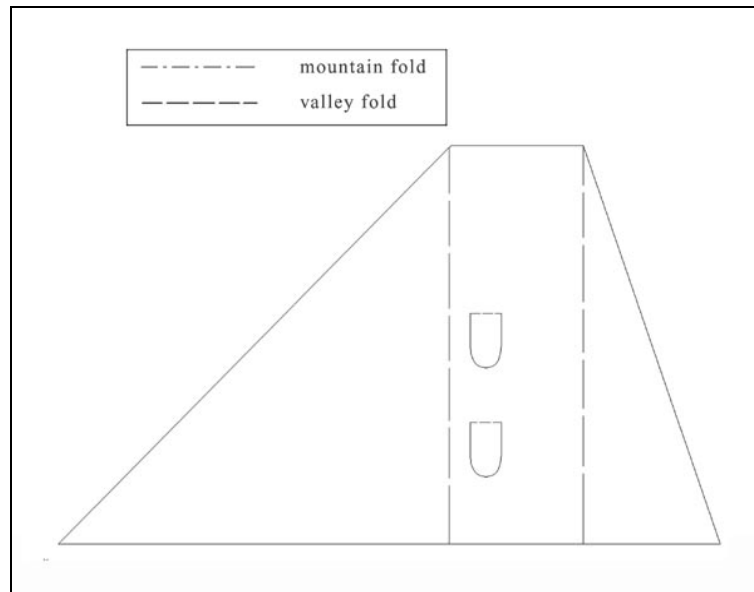

Figure 4.58: Crease Pattern Of Windrose

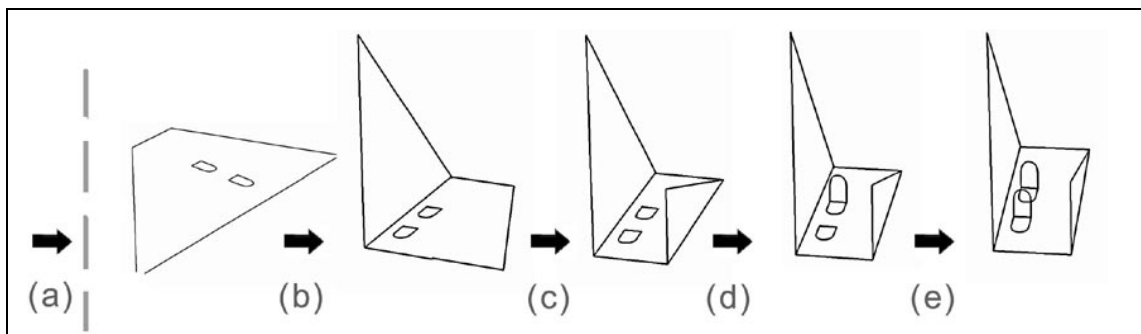

Figure 4.59: Bending sequence of Windrose

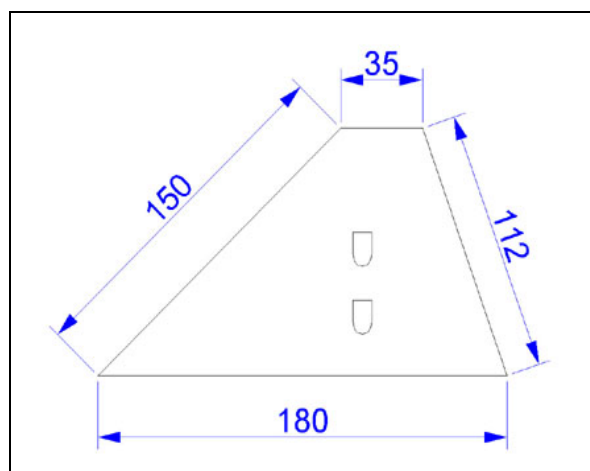

Figure 4.60: Technical Drawings of One unit Windrose in unfolded state

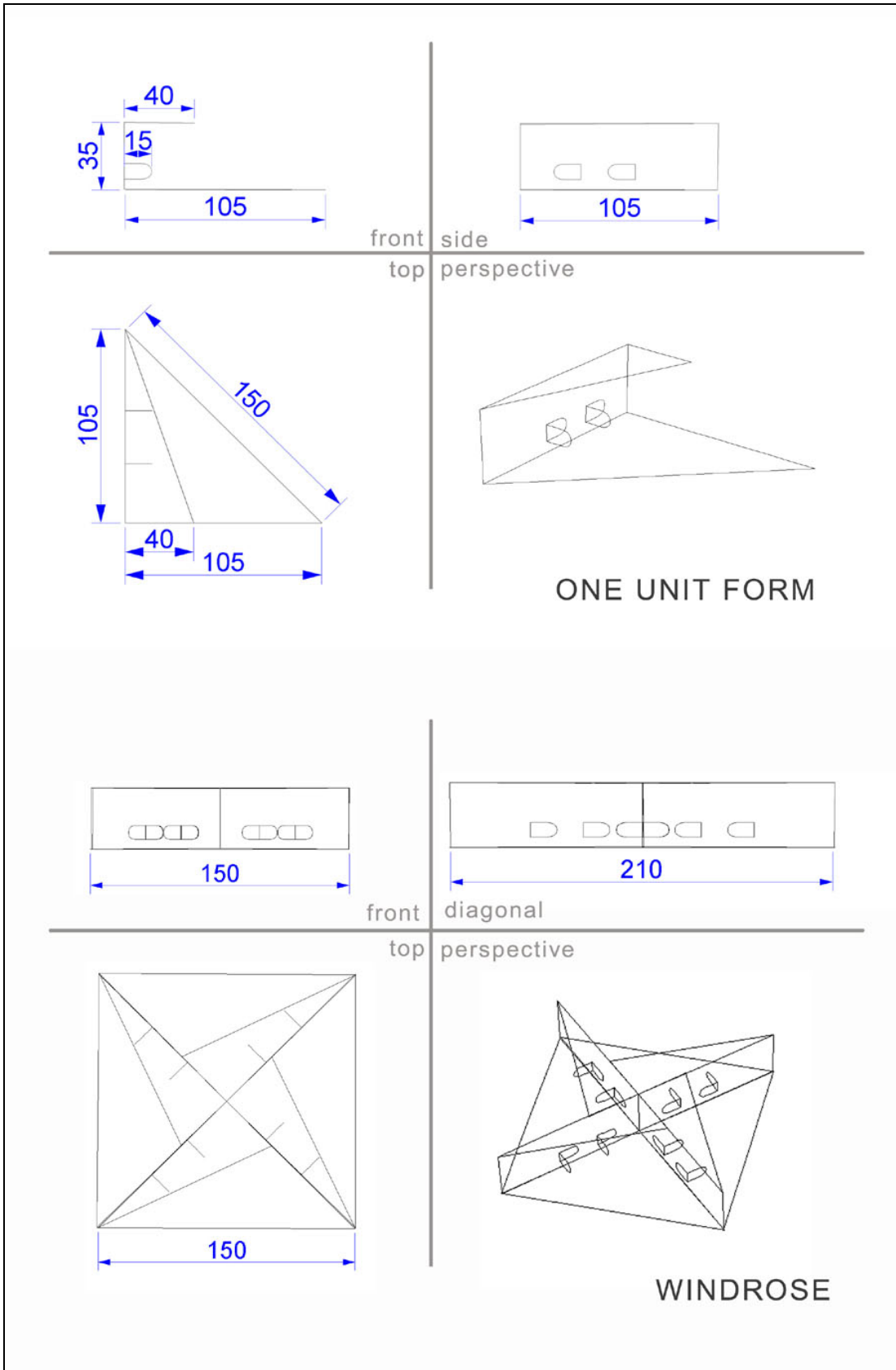

Figure 4.61: Technical Drawings of Windrose



### 4.6.3 Functional Description of Windrose

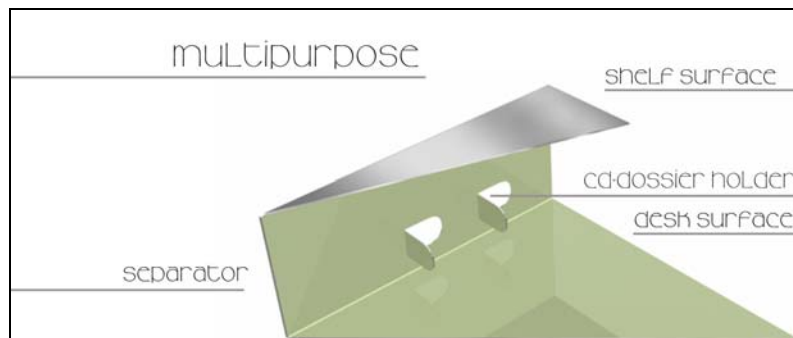

Figure 4.62: Multipurposes Of WindRose



Figure 4.63: One Unit Form Of WindRose

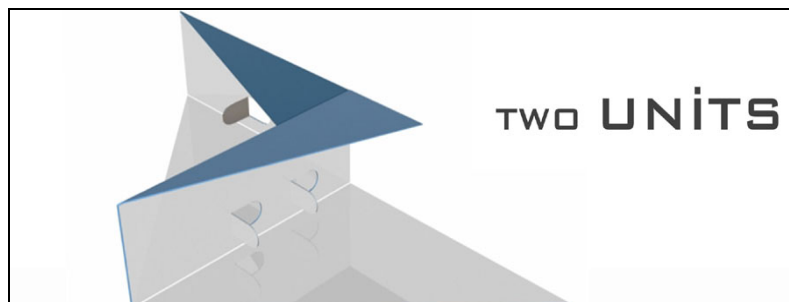

Figure 4.64: Two Units Form Of WindRose



Figure 4.65: Four Units Form Of WindRose



Figure 4.66: Perspective Previews of WindRose

#### 4.7 Radius

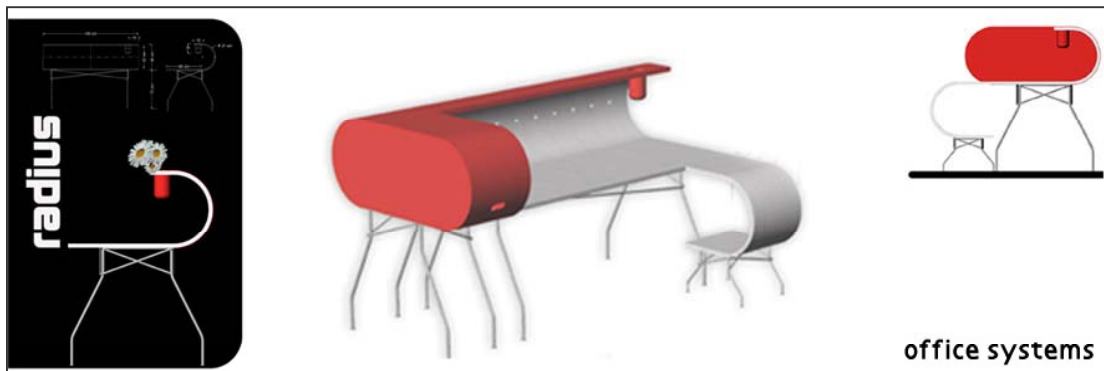

Figure 4.67: Radius Office Systems, Delta Office Systems Design Competition 2003:  
Honorable Mention, designed by Nergiz Yiğit, 2003

### 4.7.1 Problem Definition

Radius is a open office system fabricated from plywood by single plywood bending process (see Section 3.3.2.). The design adds to the strength of the material; and also the shape itself solves functional and structural issues. With its single piece construction and its continuous surface, the spaces for writing, shelving and separating spontaneously take shape.

### 4.7.2 Formal Description of Radius

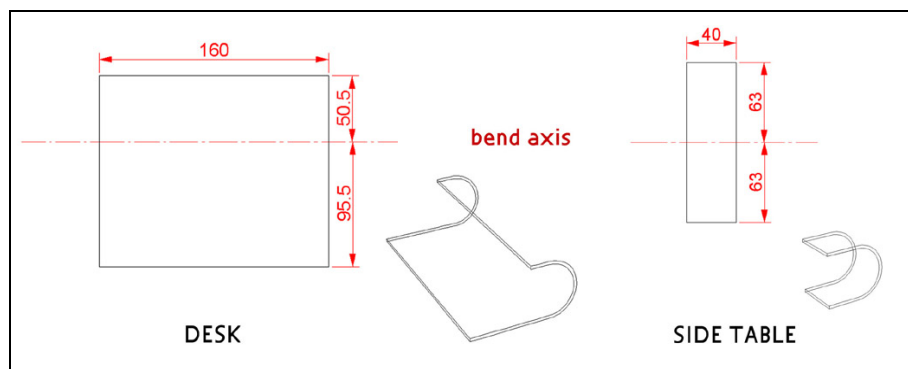

Figure 4.68: Bending of Radius

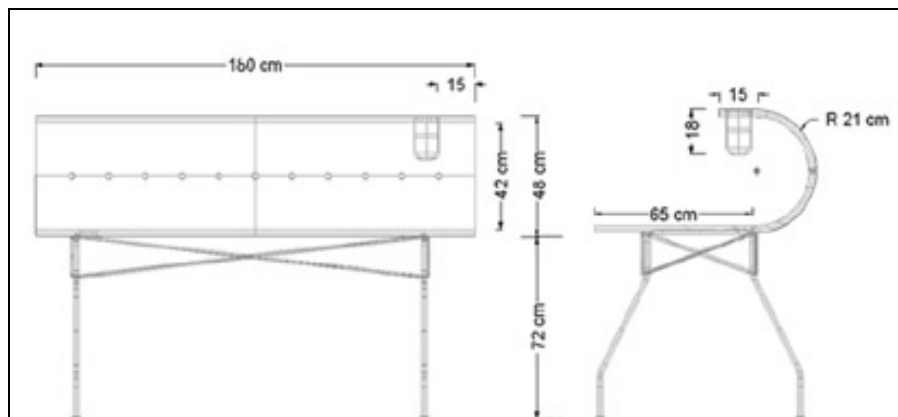

Figure 4.69: Technical Drawings of Radius

### 4.7.3 Functional Description of Radius

Tubular cd and dossier holder could be assembled to the small holes on the lateral shelf surface. Pencil case or a vase can be hanged for obtaining friendlier

environment. By means of preferring one-side laminated plywood with impressive color, it has been added great graphical effect to this plain office systems.

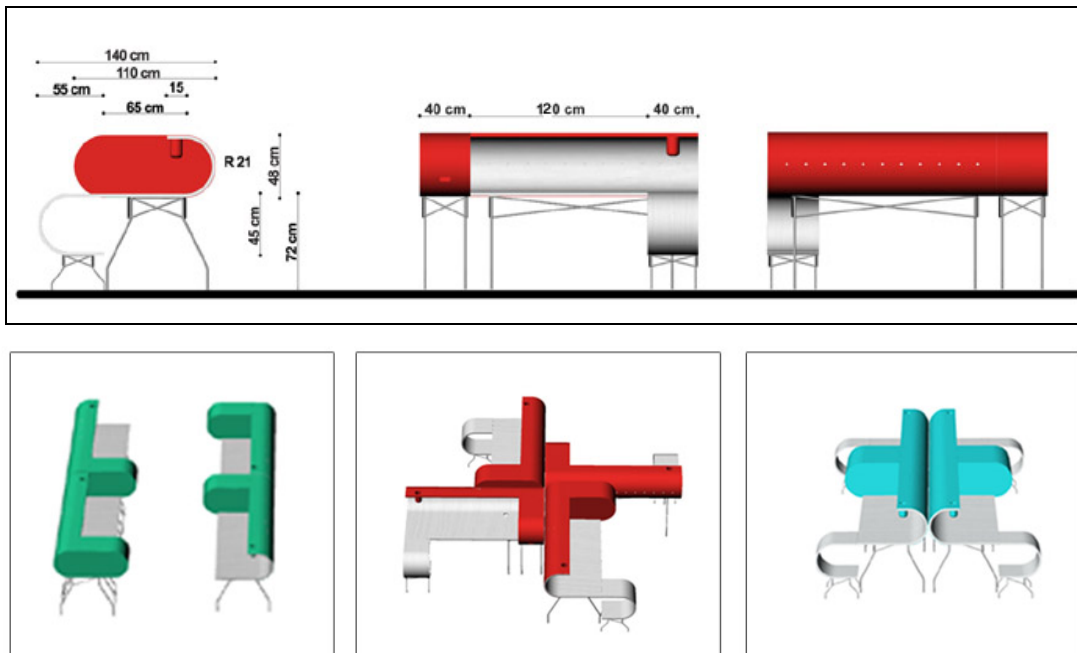

Figure 4.70: Alternative combinations of Radius

## **CHAPTER 5**

### **CONCLUSION**

The abstract forms given to sheets by applying straight, curved or combination of these folds give way to amazing and motivating results. The products, which are originated by using this method, are rich in design as well as function, and also they have added value of a low production cost with the use of conventional technology.

Moreover, the nature of the material, a flat sheet is sufficiently rigid to structure the work piece, however flexible enough to allow it to bend easily. By means of this characteristic, origamic-structured products give way a low cost, functional and aesthetic alternative for small and medium companies to develop high quality products. Using simplified solutions as well as economical manufacturing processes, which do not rely on high investments, will lead to producing internationally competitive products through the design of new forms. On one hand, the concept about the product that thoroughly finished by the client itself saves the manufacturer a step in the process, and on the other hand these products spark up the client's attention towards the product. Besides, origamic-structured products have a single piece, simple, light and mostly free standing construction, which is produced by simple bending operations. Thus these products are easy to manufacture, easy to maintain and easy to construct (because mostly they need no joints owing to their single piece construction from mono-material). Moreover, they have ease of functioning, and also have multifunction. In the event of origamic-structured products are made from thin sheets, by means of the elasticity of these materials, the products are self-lockable or flat foldable, consequently flat packable. In the case of the products are made from thick sheets, it is also possible to design it stackable. These characteristics bring about the ease of transportation and packaging.

If all of these characteristics and its form are evaluated by considering good design principles, it is clearly perceived that, nearly all of these principles have been applied to origamic-structured product. In such a way, it enhances the quality of the user experiences. Real enhancement often can be achieved through designing and implementing small, evolutionary adaptations. The important consideration is that any enhancement must be related to the whole concept and process. From the this point of view, the perforating strategy on sheet material forming makes the rigid sheet material

easy to bend by hand, or the products designed by considering the springy effect of thin sheets are self locked by hand. The consumer buys such products in a flat packing state, and then built it oneself. Thus the assembly is converted to an interactive event, and the consumer is transformed into a designer, who forms the objects.

It is honest, because it is comprehensible and self-confident. It does not appear more than it does, and it expresses the material, which it was created from. In other words it is honest, because its form and its context are compromised.

It is aesthetic. If it is considered that an aesthetic appeal is a cultural construct, there is no doubt that an origamic-structured product is a cultural construct, which is constituted by mediating with Western materials and Eastern traditional culture. Besides, the aesthetic experience refers to the feelings of pleasure that result from an interaction with an artifact. Aesthetics involve the psychological and physiological effects of line, shape, color, texture, tone, composition, context, and etc. Because of the origamic-structured product is constituted by considering geometry, order, and polygonal shapes, the aesthetic of this product has a universal meaning. Moreover, the integrity and harmony of the whole are spontaneously achieved in the aesthetic of the origamic-structured product. Especially in the event of considering the modular origami design, it is possible to achieve impressive graphical effects by using two sides colored, printed or laminated sheet materials.

It is innovative. Innovation involves a fashioning of existing materials, methods and processes into new or adapted forms to meet the needs of a changing environment. Innovation often becomes confused with originality that is genuinely new, radical, and revolutionary. Innovation is more evolutionary. In this context, thanks to the experimental studies on plywood and plastic sheets, the material itself is converted to an innovation, and also by means of the developments on laminating technology, especially plywood products gains added value in the context of emotional appeal. On the other hand, although the sheet metal is traditional material, by means of the technological development on tooling, unexpected forms are achieved by using a traditional material.

Its form follows its functions, in such a way that, its form is the resolution of its function, and it displays its logical structure.

It is minimal. In designing the origamic-structured product, the 'unimportant' is omitted in order to emphasize the 'important'. This product is characterized by simplicity that is governed by order and clarity, and also elegance and spare use of

detail (because the small details often ruin the potentiality of good design by disturbing the wholeness). The origamic-structured product itself minimal because it is designed by considering origami design, which has the minimalism concept in itself. This minimalism results from the abstraction concept. Furthermore it is minimal in material and also packaging. In addition, by means of the technological development on CNC machinery and tooling technology, especially the whole sheet metal manufacturing process can be fully automated. So, in the event of the product produced by automated press brake bending, it is minimal in waste of time and energy, and eventually it is maximal in productivity, thus it is minimal in cost.

It is sustainable, because it fulfills the necessity of sustainable design either in regarding the necessities on material and construction, or regarding the necessities on functioning such as minimization of joints, flat packing, ease of maintaining, monomaterial, lightness, simplicity, and multipurpose.

When the origamic-structured industrial products are evaluated by in the point of 'integrity', which is the most important criteria to judge a design, there is no doubt that these products inevitably has integrity in material, integrity in form, integrity in manufacturing and integrity in functioning. By means of these integrities, the appearance of an origamic-structured product is integrated into a pleasant whole. Furthermore in tooling, production, packaging and transportation, it is low in cost and it has ease of maintenance. Moreover, in the point of 'utility', its each feature is shaped so that it communicates its function to the user.

Consequently, origami design is recommended to the designer as a design tool in 'concept creating phase' (in the context of its concepts), in 'form creating phase' (in the context of its design principles), and also manufacturing phase (in the context of its techniques). Although a product to be considered aesthetically acceptable depends on culture and personal taste, there is no doubt that considering origami design provides a rich source of useful forms for the design of industrial products, all which can be obtained by the simple process of bending a sheet material.

## REFERENCES

- Alexander, C., *Notes On The Synthesis of Form*, Harvard University Press, Cambridge, Massachusetts, 1964
- Andersen, E. M., "What Is Origami" 2004  
website: <http://www.paperfolding.com/history/index.php>
- Asensio, P., *Product Design*, teNeues Publishing Company, New York, USA, 2002
- Bender, M. A., Demaine E. D., and Demaine M.L., "When Can You Fold a Map?" in *ArXiv*, Vol. **3** - No. **31**, Aug 2003, [http://lanl.gov/PS\\_cache/cs/pdf/0011-0011026.pdf](http://lanl.gov/PS_cache/cs/pdf/0011-0011026.pdf)
- Bain, I., "The Miura-Ori Map" in *New Scientist*, London, UK, issue of 23/10/1980
- Beatty, V., "Origami Origins"  
website: <http://www.lib.utexas.edu/Exhibits/origami/history/origins.html>
- Bitzel, H., and Borchardt J., *The Fascinating World of Sheet Metal*, Trumpf GmbH+Co., Stuttgart, Germany, 1996
- Byars, M., *Design In Steel*, Laurence Kings Publishing, London, UK, 2003
- Cho, J. R., Moon, S. J., Moon, Y. H., and Kang, S.S., "Finite element investigation on spring-back characteristics in sheet metal U-bending process", in *Journal of Materials Processing Technology*, Number **141**- January 2003, pp. 109–116
- Cipra, B. A., "In the Fold: Origami Meets Mathematics", in *SIAM News*, USA, Vol. **34** - No. **8**, 2001, pp. 2-3
- Comish, E.H., *Materials and The Designer*, Cambridge University Press, Cambridge, 1987
- Crankshaw, E., "The East And West of Origami", 2001  
website: <http://fly.hiwaay.net/~ejcranks/arth193b.html>
- Critchlow, K., *Order In Space*, Thames & Hudson, Great Britain, 1969
- David Mitchell's Origami Heaven, website: <http://www.mizushobai.freemove.co.uk>
- Demaine, E. D., Demaine, M. L., and Lubiw, A., "Folding and Cutting Paper", *Japan Conference on Discrete and Computational Geometry (JCDCG'98)*, Dec. 1998, Tokyo, Japan, pp. 104-117
- Demaine, E. D., "Folding and Unfolding", A Doctorate Thesis of Philosophy in Computer Science, University of Waterloo, Canada, 2001
- Encarta & Microsoft Online Encyclopedia, website: <http://encarta.msn.com>



- Engineering Technical Manual, website: <http://www.efunda.com>
- Guest, S. D., De Focatiis S.A., “Deployable membranes designed from folding tree leaves”, FirstCite e-publishing, UK, 2002  
website: <http://civ.eng.cam.ac.uk/dsl/leaves.pdf>
- Gurkewiz, R. and Arnstein, B., *3-D Geometric Origami Modular Polyhedra*, Dover Publications, Toronto, Canada, 1995
- Hatori, K., “History of Origami”  
website: <http://www.jade.dti.ne.jp/~hatori/library/index.html>
- Honda, I., *The World Of Origami*, Japan Publications, Inc., Tokyo, Japan, 1965
- Johnson, P. A., *The Theory Of Architecture: Concepts, Themes, and Practices*, Van Nostrand Reinhold, New York, USA, 1994
- Kasahara, K. and Takahama T., *Origami For The Connoisseur*, Japan Publications, Tokyo, Japan, 1998
- Kenneway, E., *Complete Origami*, St. Martin’s Press, USA, 1997
- Kleiman, P., “A Guide To the Principles Of Good Design”  
website: [http://www.lancs.ac.uk/palatine/design\\_for\\_learning.html](http://www.lancs.ac.uk/palatine/design_for_learning.html)
- Kobayashi, H., Kresling, B., and Vincent, J. F. “The Geometry of Unfolding Tree Leaves”, in *The Royal Society*, No. **265**, 1998, pp.147-154  
website: [www.bath.ac.uk/mech/eng/biomimetics/LeafGeometry.pdf](http://www.bath.ac.uk/mech/eng/biomimetics/LeafGeometry.pdf)
- Lang, R. J., “Origami Diagramming Conventions: A Historical Perspective”, 2000  
[www.origami.kvi.nl-articles-diagram.pdf](http://www.origami.kvi.nl-articles-diagram.pdf)
- Lang, R. J., “TreeMaker 4.0: A Program for Origami Design”, 1998.  
website: <http://origami.kvi.nl/programs/TreeMaker/trmkr40.pdf>
- Lefteri, C., “*Plastic Materials For Inspirational Design*”, Rotovision SA, Switzerland 2001
- Leonardi, R., “A brief history of Origami”, 1997. Translated by Silvia Biondi,  
website: <http://www.origami-cdo.it/articoli/storigen.htm>
- Lesko, J., *Industrial Design Materials and Manufacturing*, John Wiley & Sons, Inc., New York, USA, 1999
- Liapi, K. A., “Transformable Architecture Inspired by the Origami Art: Computer Visualization as a Tool for Form Exploration”, 2002  
[http://archmedia.yonsei.ac.kr/research/acadia2002\\_proceedings/acadia2002/7/S7\\_1.pdf](http://archmedia.yonsei.ac.kr/research/acadia2002_proceedings/acadia2002/7/S7_1.pdf)

- Lister, D., "Two Miscellaneous Collections Of Jotting On The History Of Origami", 1998, website: <http://www.paperfolding.com/history>
- Marcus, G. H., and Hiesinger B., *Landmarks of Twentieth- Century Design: An Illustrated Handbook*, Abbeville Publishing Group, New York, USA, 1993
- Muyan C., "An analytical approach to the concept of Topography in Architecture", A Master Thesis In Architecture, IYTE, September 2003
- Nolan, J.C., *Creating Origami*, Alexander Blace & Co, USA, 1995
- Guest S.D., and Pellegrino S. "Inextensional Wrapping of Flat Membranes." *First International Conference on Structural Morphology*, Montpellier, 7-11 September 1992, pp. 203-215
- Palsun technical manual, website: <http://www.param.com>
- Pelegrino S, "Katlanan Geometriler" translated by Kaan Atalay, in *Domus M*, No. **9**, Mart 2001, İstanbul, Türkiye, pp. 144-149
- Pellegrino S., and Vincent. J., "How To Fold A Membrane", Centre for Biomimetics, U.K. 1998  
website: [www.bath.ac.uk/mech/eng/biomimetics/FoldMembrane](http://www.bath.ac.uk/mech/eng/biomimetics/FoldMembrane)
- Randerson J., "Space antennas take a tip from Mother Nature" in *New Scientist*, London, UK, Vol. **173** – No. **2329**, 09/02/2002, p. 20
- Schwartzman S., "The Words of Mathematics" 1994, website: <http://mathforum.org>
- Simon L, Arnstein B, Gurkewitz R, *Modular Origami Polyhedra*, Dover Publications, Toronto, Canada, 1999
- Smith J.S., "Notes on the History of Origami" 1996, Norwich, England  
website: <http://www.paperfolding.com/history/>
- Takeda N. "Studies of curved and straight fold of sheet and its application to products.", A Master Study In Industrial Design, Instituto Tecnológico y de Estudios Superiores, de Monterrey, 2000
- Takahashi Hidekazu, "Origami Programming Environment" Tsukuba, Japan, 2002  
website: <http://www.score.is.tsukuba.ac.jp/~ida-Ida2004.pdf>
- The Geometry Center, website: <http://www.scienceu.com>
- Tor\* S. B., Mak\* K. W., and Lee Y. T., "A Study on the Boundary Conditions of 90° Paper Pop-up Structures" Singapore, 2003  
website: <http://www.dspace.mit.edu/retrieve/3847/IMST020.pdf>
- Wang C. H. and Bourne D. A., "Design and Manufacturing of Sheet Metal Parts: Using

Features to Aid Process Planning and Resolve Manufacturability Problems”, in *Robotics and Computer-Integrated Manufacturing*, Vol. **13** - No. **3**, 1997, pp. 281-294

Wertheim M., “Cones, Curves, Shells, Towers: He Made Paper Jump to Life”, in *The New York Times Science*, June 22<sup>nd</sup>, 2004, website: <http://www.NYTimes.com>

Whitford F., *Bauhaus*, Thames and Hudson Ltd, London, 1995

Wingler, H. M., *Das Bauhaus*, Verlag Gebr. Rash&Co., Bramsche, Germany, 1975

Withers L.K., *Folding Patterns For Display & Publicity*, The Pepin Press, Amsterdam, The Netherlands, 2002