

**DESIGN AND THERMAL ANALYSIS OF  
A ROTATING SOLAR BUILDING**

**A Thesis Submitted to  
The Graduate School of Engineering and Science of  
İzmir Institute of Technology  
in Partial Fulfillment of the Requirements for the Degree of**

**MASTER OF SCIENCE**

**in Energy Engineering**

**by  
Çağlar KARADAĞ**

**January, 2006  
İZMİR**

We approve the thesis of **Çağlar KARADAĞ**

**Date of Signature**

.....

**18 January 2006**

**Assoc. Prof. Dr. Murat GÜNAYDIN**

Supervisor, Department of Architecture  
İzmir Institute of Technology

.....

**18 January 2006**

**Assoc. Prof. Dr. Gülden GÖKÇEN**

Co-Supervisor, Department of Energy Engineering  
İzmir Institute of Technology

.....

**18 January 2006**

**Prof. Dr. Zafer İLKEN**

Department of Mechanical Engineering

.....

**18 January 2006**

**Assist. Prof. Fehmi DOĞAN**

Department of Architecture

.....

**18 January 2006**

**Assist. Prof. Koray ÜLGEN**

Solar Energy Institute, Ege University

.....

**18 January 2006**

**Assoc. Prof. Dr. Gülden GÖKÇEN**

Head of Energy Engineering

.....  
**Assoc. Prof. Dr. Semahat ÖZDEMİR**

Head of the Graduate School

## ACKNOWLEDGEMENTS

Initially I would like to express my sincere gratitude and thanks to my advisor Assoc. Prof. Dr. H. Murat Günaydın for having faith in this project as well as his invaluable support, expert guidance and contributions while writing this thesis.

I also wish to thank to my co-advisor Assoc. Prof. Dr. Gülden Gökçen for her support.

I especially wish to thank Prof. Dr. Gürbüz Atagündüz for his inspiration with the subject of the thesis.

My special thanks go to my boss Naci Uzakgören for his suggestions and patience throughout this study. Special thanks also go to my colleagues at NU Engineering and friends for their contributions and moral support.

I am also indebted to my mother Şule Karadağ and father Burhan Karadağ for their support and encouragement at every moment of my life.

Last but not least, I owe great thanks to my wife Çiğdem Karadağ and little daughter Irmak Karadağ who turned all frustrations and anxieties into hope with their dearly love, patience, encouragement and support.

## **ABSTRACT**

In recent years, various rotating buildings such as residential buildings, restaurants and pubs have been designed and constructed. Most of these rotating buildings do not possess passive solar design features or they cannot respond passive solar design principles entirely because the primary design purpose of these rotating buildings is to make all spaces view the landscape as required.

Passive solar design is the optimum utilization of architectural peculiarities of a building and appropriate material selection for improving energy efficiency of a building in heating, cooling and natural lighting. While projecting a passive solar building, different factors including building orientation, latitude of the location and climatic properties must be taken into consideration.

Although passive solar buildings are superior to conventional buildings in terms of various aspects, they have some deficiencies as well. Despite insulation, large south-facing windows which are designed to maximize solar heat gain in winter turn out to be heat loss areas in cold winter nights. They also cause excessive solar heat gain in summer. So as to eliminate such disadvantages of passive solar buildings, direction of buildings can be changed in winter and in summer by rotating them.

In this project, a rotating building's thermal performance is investigated. For doing this, a thorough literature review is carried out. First, passive solar design tools are identified. Second, examples of rotating buildings are analysed. Then, a rotating cafe located at IZTECH Campus – IYTE Cafe - is designed on the basis of passive solar design criteria. The cafe is assumed to be rotating two times a year and performance of the building is compared with a conventional passive solar building by calculating heat gain and heat loss of each building. It is found that, substantial energy savings could be possible through a rotating building. Furthermore, energy savings in summer and in winter conditions are calculated respectively as 14 % and 23 %.

## ÖZET

Son yıllarda dönme fonksiyonuna sahip konut, restoran ve bar amaçlı çeşitli binalar tasarlanmaya ve inşa edilmeye başlanmıştır. Ancak bu binaların pek çoğunda pasif solar dizayn özellikleri bulunmamaktadır yada pasif solar dizayn özelliklerini tam olarak karşılayamamaktadırlar. Çünkü bu dönen binaların çoğunun tasarım amacı binanın bütün odalarının manzaradan istenilen şekilde faydalanmasını sağlamaktır.

Pasif solar dizayn, bir binanın verimliliğini arttırmak için binanın mimari özelliklerinden optimum derecede faydalanarak, uygun malzeme seçimiyle ısıtma, soğutma ve gün içerisindeki aydınlatmada binanın kendi kendisine yetebilmesi için yapılan tasarımlardır. Bir pasif solar bina tasarlanırken binanın konumu, binanın inşa edileceği yerin enlemi, iklimsel özellikleri gibi faktörlerin göz önünde bulundurulması gerekir.

Her ne kadar pasif solar bir binanın geleneksel binalara göre birçok üstünlüğü olsa da onların da bir takım aksaklıkları mevcuttur. Kışın ısı kazancını arttırmak için planlanan güneye bakan büyük pencereler, izole edilseler dahi, soğuk kış gecelerinde bir miktar ısı kaybına neden olurlar ve sıcak yaz günlerinde binanın aşırı ısı kazanmasına neden olabilirler. Pasif solar dizaynın sahip olduğu bu gibi dezavantajların önüne geçebilmek için binanın döndürülerek kış ve yaz mevsiminde yönlerinin değiştirilmesinin faydalı olabileceği düşünülmektedir.

Bu çalışmada dönem bir binanın termal performansı incelenmektedir. Bu amaçla, yoğun bir literatür araştırması yapılmıştır. İlk olarak, solar dizayn araçları tanımlanmıştır. İkinci olarak, dönen bina örnekleri incelenmiştir. Daha sonra İzmir Yüksek Teknoloji Enstitüsü kampüsünde inşa edilecek bir kafe – IYTE Cafe – pasif solar dizayn kriterlerine göre tasarlanmıştır. Kafenin yılda iki kez döndüğü varsayılarak, binanın performansı geleneksel bir pasif solar binanın performansı ile ısı ile kazanç ve kayıp hesapları yapılarak karşılaştırılmıştır. Dönem bir ev ile önemli ölçüde enerji tasarrufu sağlanabileceği görülmüştür. Ayrıca yaz ve kış koşullarındaki enerji tasarrufu sırasıyla % 14 ve % 23 olarak bulunmuştur.

# TABLE OF CONTENTS

NOMENCLATURE.....	ix
LIST OF FIGURES.....	xi
LIST OF TABLES .....	xiii
CHAPTER 1. INTRODUCTION .....	1
1. 1. The Aim of the Study .....	5
1. 2. The method of the Study.....	5
CHAPTER 2. PASSIVE SOLAR SPACE-HEATING SYSTEMS.....	5
2. 1. Direct Gain Passive Systems .....	5
2. 2. Indirect Gain Passive Systems .....	10
2. 2. 1. Thermal Storage Wall Systems .....	10
2. 2. 2. Roof Pond Systems.....	12
2. 3. Isolated Gain Passive Systems.....	13
2. 4. Passive Solar Design Tools.....	18
CHAPTER 3. ROTATING BUILDING APPLICATIONS IN THE WORLD .....	20
3. 1. Johnstone’s Rotating House.....	20
3. 2. Sunspace Rotating Homes .....	22
3. 3. Rotating Apartment in Brazil.....	23
3. 4. Galilei House in Somerset West .....	24
3. 5. Rotating Homes in Zoltingen.....	25
CHAPTER 4. SOLAR BUILDING AT IYTE, URLA .....	27
4. 1. Building Components.....	29
4. 1. 1. Insulation Materials .....	29
4. 1. 2. Wall Components .....	29

4. 1. 3. Ceiling Components .....	30
4. 1. 4. Floor Components .....	31
4. 1. 5. Window Components .....	32
4. 2. Sunspace Design .....	35
4. 3. Ventilation System Design .....	36
4. 4. Rotation System Design .....	39
CHAPTER 5. CALCULATION METHODS .....	53
5. 1. Solar Calculation .....	53
5. 1. 1. Solar Radiation Angles .....	55
5. 1. 2. Beam Radiation Acting on a Tilted Surface .....	56
5. 2. Heat Gain and Heat Loss Calculations .....	61
5. 2. 1. Conduction Heat Gain and Loss ( $Q_c$ ) .....	62
5. 2. 2. Infiltration and Ventilation Loss .....	62
5. 2. 3. Internal Heat Gain .....	63
5. 2. 4. Passive Solar Gains .....	63
CHAPTER 6. FINDINGS AND ANALYSIS .....	64
6. 1. Calculation of Monthly Useful Solar Radiation .....	67
6. 1. 1. Calculation of Sunset Hour Angles .....	67
6. 1. 2. Solar Radiation .....	68
6. 1. 3. Monthly Average Clearness Index .....	69
6. 1. 4. Monthly Average Beam Radiation Factor .....	70
6. 1. 5. Monthly Solar Radiation on a Tilted Surface .....	72
6. 1. 6. Monthly Average Absorbed Radiation .....	74
6. 2. Heating and Cooling Load Calculations .....	74
6. 2. 1. Design Parameters .....	75
6. 2. 2. Building Loss Coefficients .....	76
6. 2. 3. Heat Loss Calculations .....	78
6. 2. 3. 1. Heat Transmission Loss .....	78

6. 2. 3. 2. The Average Net Gain in the Sunspace ( $Q_{zone2}$ ).....	82
6. 2. 3. 3. Internal Heat Gains .....	84
6. 2. 3. 4. Infiltration and Ventilation Loss.....	85
6. 2. 3. 5. Sunspace Passive Solar Gain.....	89
CHAPTER 7. CONCLUSION.....	103
7. 1. Performance of the System and Results .....	103
7. 2. Conclusion and Recommendations .....	111
REFERENCES .....	113
APPENDIX A    CALCULATION TABLE.....	119



## NOMENCLATURE

$\alpha_s$	Solar altitude angle (degree)
$\beta$	Slope (degree)
$\gamma$	Surface azimuth angle (degree)
$\gamma_s$	Solar azimuth angle (degree)
$\delta$	Solar declination (degree)
$\theta$	The solar incident angle (degree)
$\theta_z$	Zenith angle (degree)
$\phi$	Latitude (degree)
$\rho$	Reflection coefficient
$\omega$	Hour angle (degree)
$\omega_{srt}$	Sunrise times
$\omega_{sst}$	Sunset times
A	Surface areas (m <sup>2</sup> )
$\overline{H}_o$	Monthly average extraterrestrial radiation (W/m <sup>2</sup> )
$\overline{H}_b$	Monthly average beam radiation (W/m <sup>2</sup> )
$H_{bn}$	Beam radiation on a plane normal (W/m <sup>2</sup> )
$H_{bt}$	Beam radiation on a tilted plane (W/m <sup>2</sup> )
$H_d$	Diffuse radiation on surface
$R_b$	The ratio of beam radiation on a tilted surface to that on horizontal surface at any time
$\overline{K}_T$	Monthly average clearness index
n	Mean day of the month

$Q$	Heat transfer through walls, roof, glass and floor (W)
$U$	Air-to-air heat transfer coefficient (W/m <sup>2</sup> C)
$T_i$	Indoor air temperature (C)
$T_o$	Outdoor air temperature (C)
$Q_i$	Internal heat gain (W)
$Q_p$	Heat gain from people (W)
$Q_{light}$	Heat gain from lighting (W)
$Q_e$	Heat gain from equipment (W)
$Q_{inf}$	Infiltration heat loss (W)
$Q_c$	Ventilation heat loss (W)
$V$	Volumetric air flow rate (m <sup>3</sup> )
$c_{pa}$	Specific heat capacity of air at constant pressure (J/kgC)
$\rho$	Air density (kg/m <sup>3</sup> )
$\bar{S}$	Monthly average absorbed radiation
$(\overline{\tau\alpha})$	Transmittance-absorption product

## LIST OF FIGURES

<b><u>Figure</u></b>	<b><u>Page</u></b>
Figure 2. 1. Direct gain passive system.....	6
Figure 2. 2. An example house built on direct gain principles in Wooden Australia .....	6
Figure 2. 3. A roll-up window insulation .....	7
Figure 2. 4. Rigid window insulation .....	7
Figure 2. 5. Clerestory.....	8
Figure 2. 6. Overhang.....	9
Figure 2. 7. Day and night working principle of Trombe Wall .....	11
Figure 2. 8. Day and night working principle of water wall.....	12
Figure 2. 9. Day and night working principle of roof pond system .....	13
Figure 2. 10. Day and night working principle of isolated gain passive system .....	15
Figure 2. 11. Examples of sunspace designs .....	17
Figure 3. 1. Section and side view of Johnstone’s Rotating House .....	20
Figure 3. 2. Construction details of Johnstone’s Rotating House.....	21
Figure 3. 3. Sunspace Rotating House .....	22
Figure 3. 4. Rotating Apartment in Brazil.....	23
Figure 3. 5. Galilei Rotating House.....	24
Figure 3. 6. Two rotating houses in Zoltingen.....	25
Figure 4. 1. Sun paths for summer and winter in their projected forms for İzmir.....	28
Figure 4. 2. Section of the walls.....	30
Figure 4. 3. Section of the ceiling .....	31
Figure 4. 4. Section of the floor .....	32
Figure 4. 5. IYTE Café sunspace design according to summer and winter sun paths ....	35
Figure 4. 6. Vents on the common wall between the living space and the sunspace.....	37
Figure 4. 7. Example vent.....	38
Figure 4. 8. Computer-aided reducer design.....	40
Figure 4. 9. IYTE Café rotation system .....	41

Figure 4. 10a. IYTE Café settlement plan .....	42
Figure 4. 10b. IYTE Café settlement plan.....	43
Figure 4. 11. IYTE Café plan.....	44
Figure 4. 12. IYTE Café section plan.....	45
Figure 4. 13. IYTE Cafe Solar lighting principle .....	46
Figure 4. 14. IYTE Café - South view .....	47
Figure 4. 15. IYTE Café – North view.....	48
Figure 4. 16. IYTE Café – West view .....	49
Figure 4. 17. IYTE Café – East view .....	50
Figure 4. 18. IYTE Café – 3-D Settlement view .....	51
Figure 4. 19. IYTE Café – 3-D South view.....	52
Figure 5. 1. Direct, diffuse and groun-reflected radiation on a tilted surface.....	54
Figure 5. 2a. Zenith, slope, surface azimuth, solar azimuth angle for a tilted surface....	54
Figure 5. 2b. Plan view showing solar azimuth angle.....	54
Figure 5. 3. Thermal system of the cafe .....	61
Figure 6. 1. Simplified representation of IYTE Café.....	65
Figure 6. 2. Solar radiation values in İzmir .....	68
Figure 6. 3. Elevations of the building .....	76
Figure 7. 1.Living space monthly heat loss for summer period .....	106
Figure 7. 2. Total heat gain for summer period .....	107
Figure 7. 3. Sunspace total monthly solar heat gain.....	108
Figure 7. 4. Annual heating and cooling load changes .....	109
Figure 7. 5. Monthly auxiliary heating and cooling changes .....	110

## LIST OF TABLES

<b><u>Table</u></b>	<b><u>Page</u></b>
Table 4. 1. Heat transfer coefficients of selected building components.....	34
Table 4. 2. Exterior vent areas .....	66
Table 6. 1. Calculation methodology. ....	66
Table 6. 2. Monthly values of $n$ , $\delta$ and $\omega_s$ .....	67
Table 6. 3. Monthly Average $\overline{H}$ and $\overline{H}_o$ values for İzmir.....	69
Table 6. 4. Monthly average $\overline{K}_T$ and $\overline{H}_d / \overline{H}$ .....	70
Table 6. 5. Monthly average beam radiation factor for south, north, east and west sides of IYTE Café.....	72
Table 6. 6. Monthly average solar radiation south, north, east and west sides of IYTE Café .....	73
Table 6. 7. Monthly average transmittance-absorptance product for four directions. ....	74
Table 6. 8. Monthly average absorbed radiation for south, north, east and west sides of IYTE Café.....	74
Table 6. 9. Accepted temperature design values.....	76
Table 6. 10. Total specific heat loss of the building .....	77
Table 6. 11. Monthly heat transmission loss of living space for the south-facing .....	79
Table 6. 12. Monthly heat transmission loss of living space for the north-facing.....	80
Table 6. 13 Monthly heat transmission gain of living space for the south-facing.....	81
Table 6. 14. Monthly heat transmission gain of living space for the north-facing .....	82
Table 6. 15. Monthly average sunspace temperature .....	84
Table 6. 16. Monthly sunspace heat transmission loss for two directions .....	84
Table 6. 17. Monthly sunspace heat transmission gain for two directions.....	85
Table 6. 18a. Monthly infiltration loss for the living space for two directions .....	88
Table 6. 18b. Monthly infiltration gain for the living space for two directions .....	88
Table 6. 19a. Monthly infiltration loss for the sunspace for two directions.....	89
Table 6. 19b. Monthly infiltration gain for the sunspace for two directions.....	89

Table 6.20.Total monthly solar heat gain of living space for south-facing position .....	<u>91</u>
Table 6.21.Total monthly solar heat gain of living space for north-facing position.....	92
Table 6. 22. Total monthly solar heat gain of the living space for rotation .....	93
Table 6. 23. Total monthly solar heat gain of sunspace for south-facing position. ....	94
Table 6. 24. Total monthly solar heat gain of sunspace for north-facing position .....	95
Table 6. 25. Total monthly solar heat gain of sunspace for rotation.....	96
Table.6. 26. Net heat gain of the sunspace for south-facing position .....	97
Table.6. 27. Net heat gain of the sunspace for north-facing position .....	97
Table.6. 28. Net heat gain of the sunspace for rotation.....	98
Table.6. 29.Total heating and cooling load of the living space for south-facing position .....	99
Table.6. 30.Total heating and cooling load of the living space for north-facing position .....	100
Table.6. 31. Total heating and cooling load of the living space for the rotation .....	101
Table.6. 32. Annual auxiliary heating and cooling energy.....	102
Table.6. 33. Energy load comparison of cases.....	102

# CHAPTER 1

## INTRODUCTION

### 1. 1. The Aim of the Study

Rotating buildings offer invaluable benefits for energy efficient design. Rotating buildings could make the best use of solar energy. This concept becomes increasingly important since the progressive decrease of the energy resources on earth and the increase in CO<sub>2</sub> emissions together with the rise of energy costs are actual problems in today's world. For that reason the use of alternative energy resources in heating, cooling and lighting buildings has began to be (or will be in a short period of time) obligatory. Solar energy, supplying both heat and light, is mostly applied energy resource to achieve these requirements.

The efficiency of passive solar design in utilization of solar energy has been accepted for a long time. When it is integrated to the building design carefully, passive solar buildings can trap useful solar energy. Some of the natural processes that help heat, cool and light a building can be managed partially with passive design. For instance, with the help of two primary elements of passive systems – south-facing window and thermal mass – direct gain systems utilize 60-70% of the sun's energy in producing heat (Kreider et al. 1989). Solar energy passes through the large south-facing window and then, it is absorbed by thermal mass to be used later.

On the other hand, there are some problems that may arise with passive solar design. These are glare from direct sun, overheating in summer and excessive heat losses in winter. To give one example from direct gain passive systems, in winter large south-facing windows are very influential for space heating whereas they become defects of the system for winter nights because a significant amount of heat is lost through these windows as well. Conversely, in summer, south-facing windows admit more solar energy than it is desired. Similarly, Trombe Walls provide enough energy to live in comfortably in winter but in summer, though the vents are closed, excessive heat will be gained due to large thermal mass and this will result in overheating in summer. Trombe walls also occupy more area than a conventional wall so a portion of living area

is lost because of this. All of these issues make the living space uncomfortable in some climates and seasons. Besides, extra sum of money for air-conditioning and backup heating has to be spent to make the living space more comfortable. These factors lead the designer consider various elements including heat gain, heat loss, insulation problems, window sizes, building orientation, shading, ventilation etc.

Thus, the starting of this project has been to find a solution to the shortcomings of a conventional passive solar house. Insulation and shading measures cannot solve the problem completely. Therefore, various questions have been focused on beforehand such as if a passive solar building rotates from south to north, can it be a solution to these shortcoming, if south-facing windows face the north in summer, can it prevent overheating, if small north-facing windows face the south, can it prevent overheating?

Many researchers, architects and engineers are aware of the solar energy potential of Turkey. Turkey has a potential of 2640 hours annual and 7,2 hours daily solar radiation duration with intensity of 1311 kWh/m<sup>2</sup> annual and 3,6 kWh/m<sup>2</sup> daily solar radiation as it is given in “Energy Information Administration”. The data show that passive solar buildings can work well in Turkey but whether addition of a rotation system can increase the efficiency of passive solar houses by eliminating the deficiencies is not clear.

In recent years, some rotating restaurants, pubs etc. have been built as separate units of hotels and shopping centres in Turkey. In the world, some rotating residential buildings have been built but for most houses, the use of a rotation system is generally a matter of aesthetic need for maximizing the view. Increased solar gain has been integrated to former aim of rotating houses in some cases. Wholly rotating buildings, which depend on passive solar design principles, have not been built in Turkey yet.

In this project, a passive solar building will be designed to utilize solar energy to reduce energy costs. The features of direct gain, indirect gain and isolated gain passive systems will be applied to the solar house. A rotation system will be added to the solar house in order to overcome all of the shortcomings due to passive solar design such as excessive heat losses at night and in winter, overheating at daytime and in summer, shading, ventilation and insulation problems.

The building is assumed to function as a cafe at IZTECH Campus. Difference in energy gains and energy losses between a conventional passive solar building and a rotating passive solar building will be compared. As a result of the project, it is expected



that the addition of a rotation system to a passive solar house will decrease heat losses and increase heat gains and this will result in a fall in heating and cooling costs.

## **1. 2. The Method of the Study**

In order to find out whether a rotating solar building is more efficient than a conventional building or not, first of all, a thorough literature survey has been conducted on passive solar space-heating systems, solar calculations, passive solar design principles, etc. That constitutes the background information of the design of IYTE Cafe.

Examples of rotating houses from the world have been examined and information about these houses is given in Chapter 3. Similarities and differences of them will be focused on so as to get knowledge about the construction aims and rotation system functions. Various rotation systems and rotating house designs are studied with the examples.

Chapter 4 elaborates on design principles of IYTE Cafe. In this chapter, the place and location of the cafe, the principles upon which the cafe will be built are explained and implemented. Detailed information about the materials utilized in systems of the cafe, such as rotation system and ventilation system, are given in separate sections.

The following chapter investigates calculation methods that have been used in this project. First, solar calculations are explained and rules and equations that are used in project calculations are given because principle energy resource of IYTE Cafe is solar energy. Later, heat gain and heat loss calculations are examined under the same heading.

Calculations of IYTE Cafe are done in Chapter 6. As the cafe rotates two times a year, the elevations facing the four directions – south, north, east and west – change depending on the period. For instance, in summer period sunspace of the cafe faces the north whereas it faces the south in winter.

To differentiate calculations concerning the above-mentioned aim of the project, they are studied under three different cases. First and second cases include calculations of a conventional passive solar house in two different position, south and north while third case examines the calculations of rotating passive solar cafe. Results concerning

the three cases in two different periods are given in the next section to find out the performance of the rotation system.

Autocad, Archicad computer programmes have been utilized for architectural and 3-D architectural view of IYTE Cafe. Sap2000 computer programme has been used for static calculations.

## **CHAPTER 2**

### **PASSIVE SOLAR SPACE-HEATING SYSTEMS**

The principle of passive solar space-heating systems is the utilization of solar energy in the heating of buildings without the help of technology (Wachberger 1988). It is directly related to passive solar design of buildings. Passive solar design relies on the integration of a building's architecture, materials selection and mechanical systems (though sometimes they are considered as active) to reduce heating and cooling loads. It takes into consideration local climate conditions, such as temperature, solar radiation and wind, to create climate-responsive, energy conserving structures.

Passive solar energy refers to collection systems that do not involve the input of other forms of energy to increase the effectiveness of the collection system. This usually refers to pumps, blowers and automatic systems to aim collectors, lenses or mirrors. However, many systems are still classified as passive even if they involve electrical and mechanical systems to close insulating shutters or move shades. Passive solar systems are considered direct system although sometimes they involve convective flow which technically is a conversion of heat into mechanical energy (Kreider et al. 1989 ).

The goal of all passive solar space-heating systems is to capture the sun's heat within the building elements and release that heat during periods when the sun is not shining (Eğrican and Onbaşıoğlu 1996). Different methods used in the collection, storage, and distribution of the sun's energy are the distinctive factor in classifying passive solar space-heating systems. Direct gain passive systems, indirect gain passive systems and isolated gain passive systems are three mostly used types of passive systems.

#### **2. 1. Direct Gain Passive Systems**

As indicated in "Design for the Sun", in direct gain passive systems, the solar collector, heat absorber and distribution of the system is the actual living space. The sunlight heats the building by passing through a large south-facing window. The solar energy that passes through the window is absorbed by thermal mass - floors, walls and furniture and it is reflected to ceilings. This absorption and reflection converts solar

energy to heat (Figure 2. 1). Heat production during daytime hours is sufficient for space-heating with direct gain systems since the system utilizes approximately 60-75% of the sun's energy striking the windows.

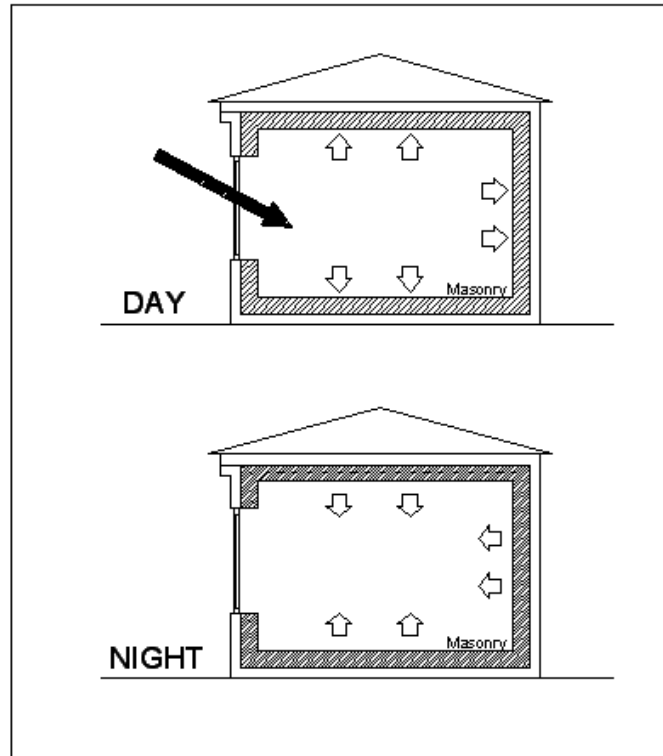

Figure 2.1 Direct gain passive system (modified from Wachberger 1988)



Figure 2.2. An example house built on direct gain principles in Wooden, Australia (Source: WEB\_10, 2005)

Although direct gain systems are very effective in producing heat during daytime, they are also very effective in losing heat at night. For example, at night or overcast periods, a large amount of heat is lost through large south-facing windows which are designed to be the heat source of houses. There are some methods to eliminate heat loss through windows, such as installing insulation either outside or immediately behind the window (Carter and de Villers 1987). Added night time insulation can be chosen as a roll-up kind of flexible insulation or a movable arrangement of rigid insulation (Figure 2. 3; Figure 2. 4) “The thermal resistance of movable insulation should be at least  $1 \text{ m}^2 \text{ KW}$  and preferably closer to 2, subject to an economic analysis of the heat cost-effectiveness of the increased insulation” (Kreider et al. 1989). If south-facing aperture is thought to be constructed of double pane glass, that has the resistance of approximately  $0.35 \text{ m}^2 \text{ KW}$ , the addition of movable insulation at the recommended level can reduce heat losses through window by a factor of 5.

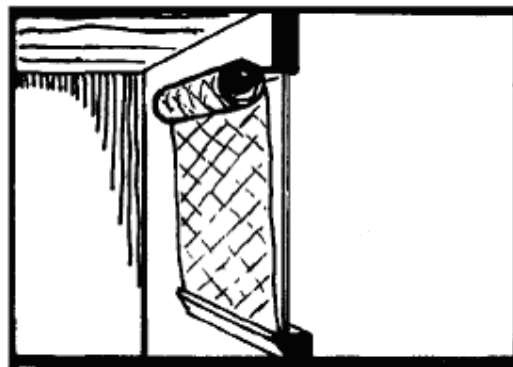

Figure 2.3 A roll-up window insulation  
(Source: WEB\_8, 2005)

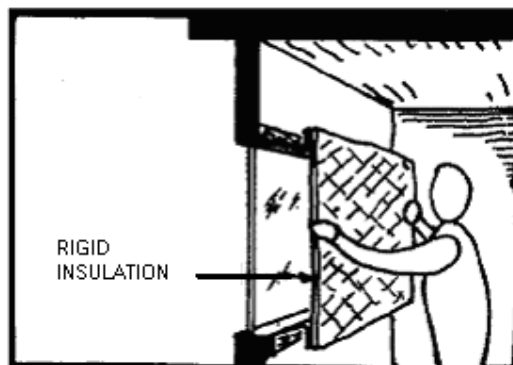

Figure 2.4 Rigid window insulation  
(Source: WEB\_8, 2005)

It is important to remember that the thermal mass must also be insulated from the outside since the collected solar heat can drain away rapidly, especially when thermal mass is directly connected to the ground, or in contact with outside air.

Direct gain systems are good providers of natural lighting. Large south-facing windows admit a large amount of sunlight. For large areas, clerestories (Figure 2. 5) can be used to provide sunshine onto interior walls which would normally not have a clear view of winter sunlight (Wachberger 1988).

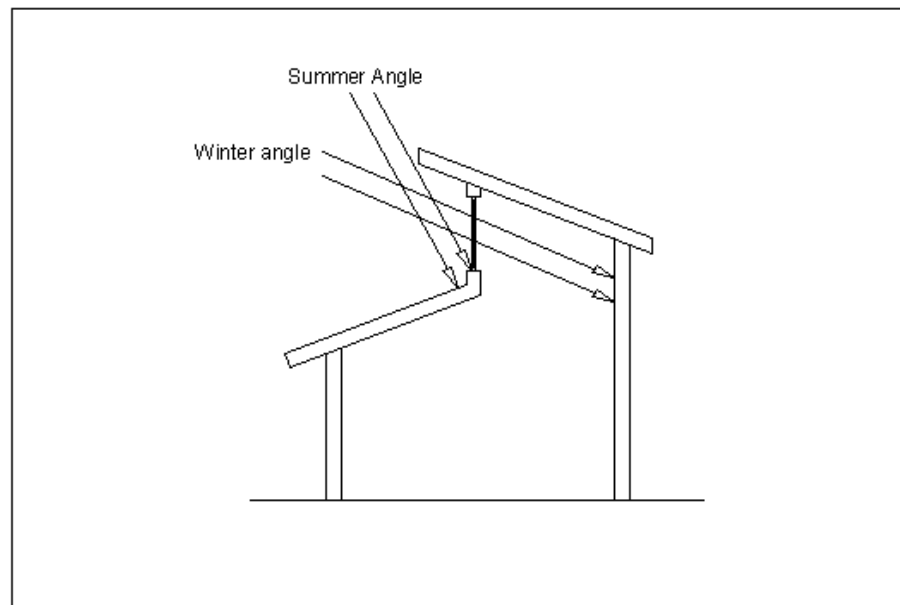

Figure 2. 5. Clerestory (modified from Wachberger 1988)

On the other hand, overheating occurs during daytimes in summer due to too much solar gain from the south-facing window. Shading can be a solution to this problem as well. Another solution to eliminate summer overheating is designing overhangs with regards to the angle of the sun in winter and in summer for the related latitude. As it is shown in Figure 2. 6, overhangs allow low winter sun in the building so a large amount of winter sun is captured and stored in the building. However, in summer, the sun follows a higher angle which is prevented from entering the building by the overhang. Therefore, less solar energy is gained and absorbed in the building (Rapp 1981).

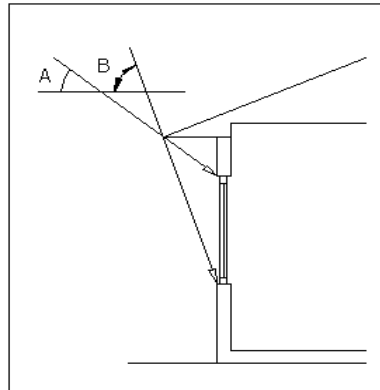

Figure 2. 6. Overhang: (A) represents summer angle of the sun, (B) represents winter angle of the sun (modified from Wachberger 1988)

General rules of thumb for direct gain passive systems are pointed out in “Passive Solar Design” as;

- Design of passive solar systems depends directly on solar features so the design of passive solar features or direct gain systems is influenced by specific regional circumstances such as latitude, climate, and building traditions. Therefore, while designing a direct gain system these features should be kept in mind.
- Fosdick and Homes claim in “Passive Solar Heating” that orientation of a building should be decided carefully. The buildings (for passive solar systems) should be oriented as close to a north-south-east-west axis as possible, usually with the long axis of the building running east-west for maximum exposure towards the south.
- The key component of any passive system in the northern hemisphere is the south-facing glass because most of the solar gain is obtained through these windows. In order to have a good performance in winter, solar glazing (south-facing windows) must be adequate.
- Windows should be projected carefully since most of the heat gains and losses are through the windows (Hans and Lembke 1985). To heat an adjacent space with direct gain system, the adjacent space should be no more than 2.5 times of the south-facing window. This rule is found according to the geometry of the sun in winter (Kreider et al. 1989).
- North-facing windows, which do not receive direct sunlight nearly half of the year, should be minimized. These windows are places from where a building

loses significant amount of heat so they should have high insulation or R-value glazing.

- If solar glazing is tilted, it becomes more effective as a solar collector in winter. On the other hand, tilted glazing can be disadvantageous in summer if it is not shaded well. Because of this, ordinary vertical glazing can be chosen instead of tilted glazing since it is “easier to shade, less likely to overheat and less susceptible to damage and leaking” (Moore 1993).
- East and west windows should also be shaded well because they can increase the air conditioning needs. These windows catch the morning and evening sun so there is the potential of overheating through them. With carefully planned shading and appropriate glass choice such as tinted or low-e glass, these problems can be overcome (Sayigh 1991).
- Windows should be operable in order to help natural ventilation.
- In winter when the sun rarely shows its face, the temperatures may be too low to live in comfortably. The use of thermal storage provides nearly one-third of the heat load of the building in direct gain systems. In order to avoid low temperatures at night or overcast periods, thermal storage must be sized and located properly.

## **2. 2. Indirect Gain Passive Systems**

Indirect gain passive systems utilize a system to collect and store sunlight in order to be used later. These systems include a thermal mass located between the sun and the living space and they convert sunlight to heat. By means of natural radiation and convection, stored heat is transferred to the living space. There are two types of indirect gain passive systems; thermal storage wall systems (Trombe Wall) and roof pond systems (Tombasiz and Preuss 2001).

### **2. 2. 1. Thermal Storage Wall Systems**

Thermal storage wall systems are one of the earliest applications of indirect gain systems. They were first projected and developed by a French engineer Felix Trombe and later they were used in different buildings by Jacques Michel. Therefore, these



systems are generally called as either Trombe Wall or Michel-Trombe Wall. Trombe Wall consists of a south facing glazing and a concrete masonry wall the exterior of which must be a dark colour. The glazing admits the sunlight during the day and in a way it also prevents the heat losses at night. There must be at least 4 inches between the thermal mass and the glazing (Atagündüz 1989).

Solar heat is captured and trapped by the glass and later it is absorbed by the concrete wall. It is transferred to the living space by radiation and convection. Air circulation loops help the heat transfer since they provide airflow between the inner surface of the storage wall and the living space. As airflow occurs as a result of the density difference between the air in the living space and the air in the gap, the heated air is transferred into the air circulation loop during daytime. The rest of the heat is absorbed by the thermal storage wall. Therefore, in summer, there is the risk of overheating during daytime because of the air circulation loops. If air circulation vents are added at the bottom and top of the loops, daytime and night time load periods can be balanced easily. The absorbed heat diffuses through the wall between 6 to 12 hours so the wall materials should be selected depending on the desired heat migration at night (Figure 2. 7). Moreover, thickness of the wall is also important to have a proper phase lag between heat production and delivery of it into the living space (Kachadorian 1997).

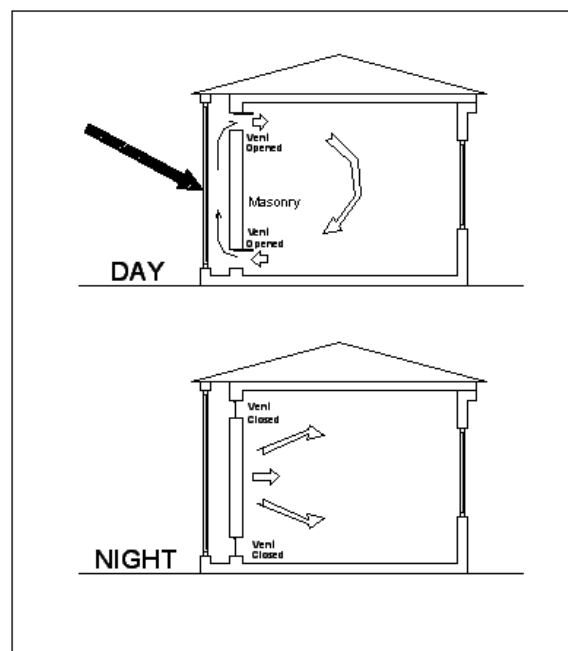

Figure 2. 7. Day and night working principle of Trombe Wall  
(modified from Wachberger 1988)

Water walls are considered as thermal storage walls as well (Figure 2. 8). They collect and store heat like Trombe Walls but water walls transfer heat through the walls as a result of convective circulation whereas Trombe Walls conduct heat through the thickness of the masonry. In water walls, water is held in light, rigid containers. They do not occupy a large place because they can provide twice the heat storage per unit volume than masonry. Their installation is easy as containers are empty before the installation. However, after the installation, most metal container rust through and leak. The length of containers is also very important since tall containers develop hydrostatic pressure near the bottom. At least 30 pounds of water should be used for each square foot of glazing (Moore 1993).

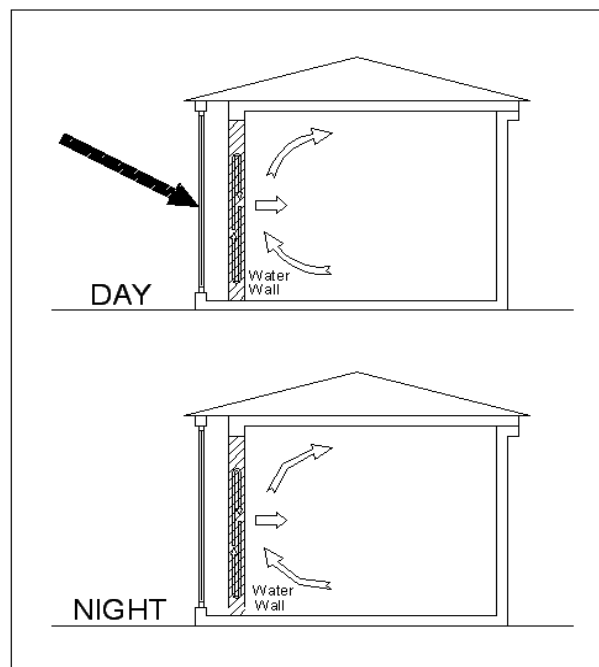

Figure 2. 8. Day and night working principle of water wall  
(modified from Wachberger 1988)

### 2. 2. 2. Roof Pond Systems

This system, as in indicated in “Passive Solar Design”, consists of a layer of water about 300 mm deep placed over a metal roof painted a dark colour (or the lower surface of the water container can be a dark colour). The heat is absorbed by the water when the sunlight passes through it. The heat can be stored in the pond until needed. Later it is conducted to the living space. As it is mentioned above, water has some

advantages over masonry as a thermal storage material. First of all, it is cheaper and lighter than masonry (Water requires one-third of the volume and one-fifth the weight of masonry). Secondly, internal convection in water ponds reduces the time lag. Heat absorbed on the solar side of the container can be transferred immediately to the bottom of the container. As it is seen in Figure 2. 9, a movable insulation is necessary for this system in order to eliminate heat loss at night. The insulation should be installed above the pond (O’Sullivan 1988).

Roof pond systems are not effective in winter in northern latitudes because the horizontal surface of these systems is far from catching optimum sunlight in this season. It is difficult to orient roof ponds at the right angle for solar collection. In winter, when the sun is at its lowest angle and when space heating loads are the highest, roof ponds are not sufficient. In addition, some type of antifreeze protection for freezing days and a structure to support large storage mass are required for roof ponds. In comparison with the low cost of storage material, these factors increase the cost of the system (Carter and deVillers 1987).

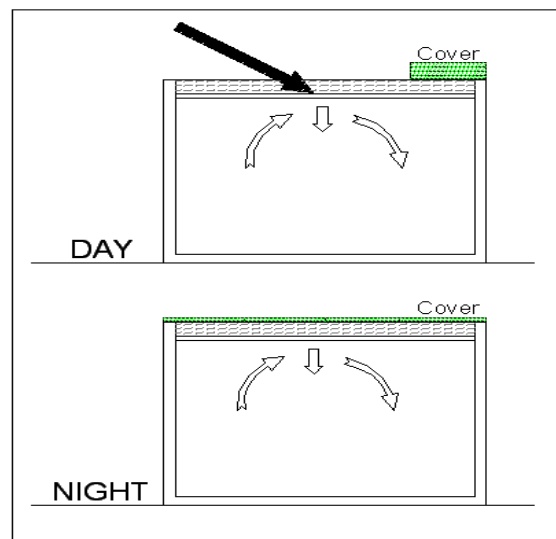

Figure 2. 9. Day and night working principle of roof pond system  
(modified from Wachberger 1988)

### 2. 3. Isolated Gain Passive Systems

If the integral parts of a passive solar system are separated from the main living area of a house then it is called isolated gain passive system. They are usually in

the form of greenhouses or sunspaces attached to the south side of a building<sup>1</sup>. *Greenhouses* generally have glass or plastic panels in the roof to allow light and heat for growing plants and early seed-starting. They are difficult to insulate in regions with very cold winters because often much heat is lost through the roof. *Sunspaces* usually have an insulated roof and full length windows on the south side. They are often more practical than greenhouses as living spaces, but will still provide an excellent environment for plants, and a more even temperature level throughout the year. Climate and desired use will dictate how a greenhouse or sunspace is designed for a particular application (Kachadorian 1998).

Isolated gain passive systems combine the features of direct gain and indirect gain passive systems as it is designated in “Solar Energy Potential for Heating and Cooling Systems”. They are heated directly by sunlight due to their totally glazed walls. This enables the isolated gain system to absorb lots of sunlight which is stored in the floor and walls. The absorbed and stored heat is later diffused to the rest of the house. During the day, the doors or windows between the sunspace and the house can be opened to circulate collected heat, and then closed at night, and the temperature in the sunspace is allowed to drop (Figure 2. 10). This is called natural convection. As these systems provide an insulating air cushion between the outside and inside of a building, the house is protected from temperature fluctuations.

However, these systems warm up very quickly and on hot summer days, temperature can rise to unbearable units. In order to stabilize the temperature in both the sunspace/greenhouse and the building, thermal mass in the form of water containers or masonry walls and floors can be used. At the same time, movable insulation helps prevent excessive heat loss at night.

One advantage of isolated gain passive systems is that they can be used as additional living spaces as well. That is why in Northern Europe, they are constructed as mainly living spaces rather than energy considerations. Ventilation, roof glass, and thermal mass are important design features that make either structure a valuable money-saving and comfort-enhancing addition to a home or design (Meinel and Meinel 1979).

A rule of thumb for sunspaces is to incorporate 3 square feet of 4-inch thick thermal mass for each square foot of sunspace glazing. A good place for thermal mass in the sunspace is the flooring. The lower edge of the south-facing windows should be

---

<sup>1</sup> Other terms used for isolated gain passive systems are solarium, atrium, conservatory and sunroom.

no more than 6 inches from the floor or the planter bed to make sure the mass in the floor receives sufficient direct sunlight. If the thermal mass is instead located in the common wall, it should be solid masonry approximately 4 to 8 inches thick, or a frame wall with masonry veneer. Windows on the east and west walls are useful for cross-ventilation but should be kept small (no more than 10 percent of the total sunspace area). Double glazing is recommended for sunspaces. Besides, at winter nights, all vents and openings ought to be closed to prevent heat losses through the glazing of sunspace (Filippin et al. 1998).

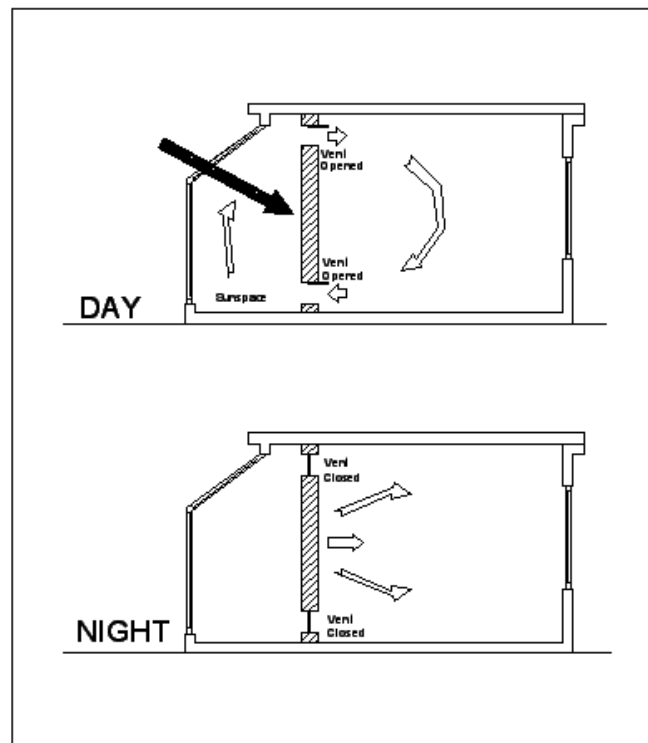
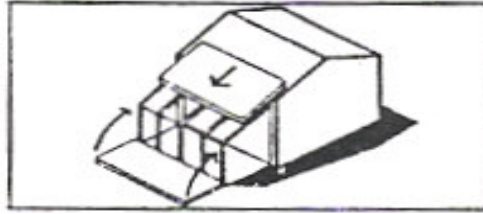

Figure 2. 10. Day and night working principle of isolated gain passive system  
(modified from Wachberger 1988)

To sum up, the following rules are to be considered in the design process of sunspaces (Moore 1993).

- The orientation of a sunspace depends on the orientation azimuth of the building, and so its principle glazing, relative to the south. The optimum orientation is always south. Departures from due south result in a fall in the performance of the sunspace.

- Sunspace and the other living spaces of the building can be separated either by a thermal storage wall or a window. If the common wall is a thermal storage wall, the wall does not need insulation. Lightweight frame common walls should be insulated to at least R-10.
- The roof of a sunspace should be designed in such a way that it shades the internal sunspace mass in summer and provides irradiation in winter. If a portion of the roof is glazed, some kind of shading is required.
- The use of glazed east and west end walls is not recommended. Despite the fact that glazed end walls increase winter heating performance a little, they also cause devastating overheating in summer. Therefore, insulated end walls with perforated windows or doors can be preferable instead of glazed wall ends. In summer cross-ventilation provided by these windows or doors proves to be adequate.
- The primary thermal connection between sunspace and the building is normally by convection and it is provided by vents (in the form of doors, windows and vents) on the common wall. The following are guidelines for sizing various opening types that can be closable at night.
  - Doors should occupy 15% of the projected glazing area.
  - Windows should occupy 20% of the projected glazing area.
  - High and low vent pairs should occupy 10% of the projected glazing area.
- Summer venting is planned for a sunspace and living space differently. If there is no shading for the sunspace, then summer ventilation becomes more important for the sunspace. Vents or windows that serve ventilation should be projected according to the climatic properties of the location and orientation of the building. Ventilation of the adjacent living space can be provided with different methods including carefully arranged vents, windows, clerestory windows etc.
- Sunspaces require the same thermal considerations as collector-storage walls or direct gain systems but the glazing area should be larger than the receiver or collector area. Depending on the different expectations from sunspaces, their designs may vary (Figure 2. 11).



Sunspace with night insulation

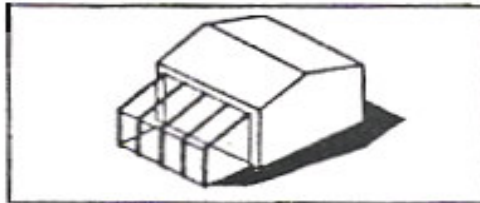

Sunspace with  $30^{\circ} + 90^{\circ}$  glazing

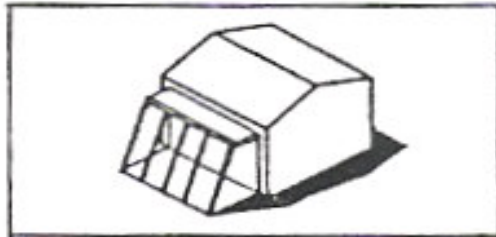

Sunspace with  $50^{\circ}$  glazing

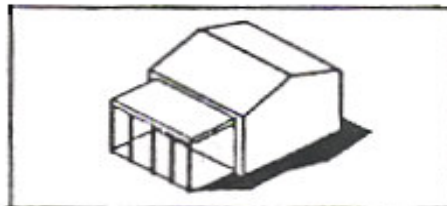

Sunspace with vertical glazing

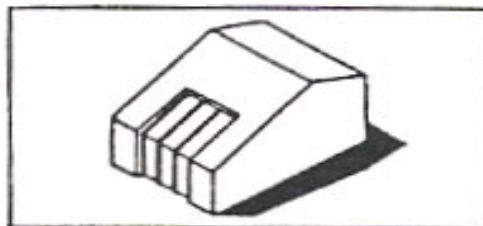

Integrated sunspace

Figure 2. 11. Examples of sunspace designs (Source: Evans et al. 1991)

## 2. 2. Passive Solar Design Tools

The small details of passive solar design and construction and passive solar features can add up to 15% to design and construction costs. However, this is one time cost for energy saving features that last lifetime of the building. Many features such as proper siting, house colour, house orientation and shape, and window placement can be considered without additional costs (Kachadorian 1997). Energy efficiency of a passive solar can be improved with;

**Siting Considerations:** During the heating season, the sun's path makes an arc in the southern sky. When designing and constructing a passive solar house, the placement of the trees, other houses and mountains which might stand between the house and the sun's path in the sky should be taken into consideration because these objects may create shadows on the building and reduce the solar collection for that section of the house.

**House Orientation and Shape:** South sides of houses receive the most solar radiation during the winter. East and west sides receive more solar radiation in summer than in winter. When designing a passive solar house, the south side of the house should be made longer than east/west side. However, it should not be so long since the area of roof and walls where heat is lost elongate as well.

**Window Placement:** South-facing glass windows allow direct sunlight to heat the house interior. In a passive solar house, south-facing windows can provide up to 30% or more of the heating load. An overhang on south-facing windows will prevent overheating in summer. On the other hand, in winter when the sun is lower in the sky, it permits sunlight to pas through the window to warm the interior. Also, too much glass on the wet side of the house, can easily overheat rooms that have already been warmed all day by the southern sky. Landscaping can be a solution to this problem. Mature deciduous trees permit most winter sunlight while providing shade throughout summer.

**Glass Design:** high R-value windows without inhibiting visibility are useful tools of a passive solar house. New low emissivity glass will decrease radiant heat loss and increase R-value without markedly lowering visibility. Sloped or horizontal glass such as skylights admit light but they are often problematic because of unwanted seasonal overheating, radiant heat loss and assorted other problems.



**Natural Lighting:** Windows are the basic source of natural lighting. As a general rule, a daylit room requires at least 5% of the room floor area in glazing. Also, Light interiors reflect more light and reduce lighting needs while dark colours absorb more solar energy that helps heat gain.

**Natural Cooling:** Apt use of outdoor air often cool a home without need for mechanical cooling, especially when effective shading, insulation, window selection and other means already reduce the cooling load. In many climates, opening window at night to flush the house with cooler outdoor air and then closing the windows and shades by day can greatly reduce the need for supplemental cooling. Cross-ventilation techniques capture cooling flow-through breezes. Exhausting naturally rising warmer air through upper level windows, such as clerestory windows, or fans encourages lower level openings to admit cooler, refreshing, replacement air.

**Heat Storage:** Thermal mass and materials used to store heat, is an integrated part of most passive solar design. Materials such as concrete, masonry, wallboard and water absorb heat during sunlit days and slowly release it as temperature drops. This dampens the effects of outside air temperature changes and moderates indoor temperatures. Optimum mass to glass ratio can be used to prevent overheating and minimize energy consumption. Besides, coverings such as carpets that inhibit thermal mass absorption and transfer should be avoided.

**Solar Greenhouse:** When attached to a south wall, a solar greenhouse provides additional collector area as well as space for house-plants in winter months.

## CHAPTER 3

### ROTATING BUILDING APPLICATIONS IN THE WORLD

Active and passive system applications in buildings have been widely and consciously used to maximize utilization of solar energy for decades. What is new and practiced by very few architects and engineers is the utilization of a rotation system for optimum solar gains. The starting point of rotating a building was at first to have an extended view for the dwellers. Later, some architects and engineers tried to obtain more solar energy with the help of a rotation system. Some of the examples of rotating buildings are given in the following parts.

#### 3. 1. Johnstone’s Rotating House

The idea of a rotating house has been studied first as a solution to maximizing the view of a house. Al and Janet Johnstone are one of the owners and builders of rotating homes who were after such a building aim. They own RotatingHome.com as well. Their motto for building rotating houses is that “RotatingHome [is] perfect for entertaining and personal enjoyment” says Al Johnstone in “The Rotating Home”.

Johnstone’s houses can be built up in different areas including beaches and mountains. They can be constructed on a central steel column which helps the construction in steep areas easier (Figure 3. 1).



Figure 3. 1. Section and side view of Johnstone’s Rotating Home (Source:WEB\_6,2005)



Figure 3. 2. Construction details of Johnstone's Rotating House (Source: WEB\_6 ,2005)

The house is driven by a three horse power DC motor. The house rides on one very large bearing (six foot in diameter) and forty small bearings (six inches in diameter). The whole building rotates  $360^{\circ}$  at different speeds. It can be stopped in any position at any time. All of these features help the basic construction aim of the house that is to have different options on the view of the rooms – maximizing the view.

The cost of the building depends on the size and type of the house being built as explained in "The Rotating Home". Compared with a conventional home, it is said that Johnstone's rotating homes cost much less per square foot the larger the home. On very large homes, 10,000 square feet or more, a rotating home could be equal in cost to a conventional one. On small ones, 5,000 square feet or less, the cost could be doubled.

### 3. 2. Sunspace Rotating Homes

Sunspace Rotating Homes has been building rotating homes since 1996. The basic principle of Sunspace Rotating Homes is to offer their clients the chance to change the view from any room according to fundamental needs and simply to follow the sun – to let the sun shine in. The firm points out the advantages of their house as the chance of varying the natural light and the view at any time of the day and in any room they like, and taking the advantage of passive solar heating and cooling. Sunspace homes are constructed in circular and octagonal designs. In addition the roof is designed to be dome shaped. The curved surface also acts as a natural convection system, making the house 40% more energy efficient than a conventional house of the same size (Architecture Week).



Figure 3. 3. Sunspace Rotating House (Source:WEB\_22 , 2003)

In “Sunspace Rotating Home” details of the buildings are given. The house turns 300 degrees on a simple, maintenance free system of bearings between a tracking system. The rotation system can be rotated manually by two or three people but installation of a small electric motor to control the house from inside by a switch or a remote control is more practical. In addition, turning the house away from the front entrance way while everybody is away can be an added measure of personal household security [49].

### 3. 3. Rotating Apartment in Brazil

As it said in “Rotating Apartment”, Suite Vollard is a rotating (eleven-storey) apartment in Brazil. Every single floor has its own rotation system so it can revolve independently. However, bathroom, kitchen and the main bedroom which are located in the centre of the flat do not rotate. It is built up of concrete and big metal platforms.



Figure 3. 4. Rotating apartment in Brazil [45]

(Source: WEB\_15 , 2005)

The floors are has 268 square meter floor area with 30 square metre balconies which open to another room in every  $90^{\circ}$ . The building is surrounded by windows sensitive to light. The rotation system consists of gears and chains. The purpose of rotating this building is to maximize the views.

### 3. 4. Galilei House in Somerset West

The house was designed by an architect, Raymond Alexander, whose revolving entertainment area design of a house later turned into a rotating upper floor by the owners' request. As expresses in "Somerset West Revolving House", the whole idea of the rotating upper level was to allow the owners to follow the sun's rays as they moved across the sky from morning to evening. The house is made of reinforced concrete and weighs 800 tonnes. It has four bedrooms and three bathrooms.



Figure 3. 5. Galilei Rotating House (Source: WEB\_21 , 2005)

The upper floor can revolve full circle to follow the sun. Details of the rotation system are given in "Somerset West Revolving House". The speed of rotation can be varied but after various speeds were tried out, it was set to complete a full  $360^{\circ}$  revolution in half an hour and a  $180^{\circ}$  turn in fifteen minutes. However, the revolving upper level makes a staircase for the house impossible. A lift is used instead of staircase. The house can turn if the lift is safely on the ground floor. The lift and rotation mechanism are linked by a computer as is the front entrance bridge of the house.



### 3. 5. Rotating Houses in Zoltingen

These houses were designed by Ernst Osswald a contractor and bricklayer from Zoltingen, in South West Germany. As it is laid out in “Rotating Homes”, the starting point of the house was a problem mentioned by a client; that is the house would be perfect if it got more sunshine. This question led him to designing rotating homes. On first viewing, the houses Osswald constructs, traditional chalet-style homes with balconies and dormer windows, look unexceptional.



Figure 3. 6. Two rotating houses in Zoltingen (Source: WEB\_16 , 2005)

These houses (Figure 3.6) are mounted on a steel turntable fitted with 960 well oiled 1.2 inch ball bearings. This rotating device is driven by a 1.5 horse power motor and costs about 70 pounds a year to run. The house can be programmed like a heating

system to run at various speeds. A full circle lasts an hour, but most owners set it to run at a more leisurely rate and follow the movement of the sun. Thus, they guarantee light and warmth throughout the day.

The basic construction principle of these rotating houses in Zoltingen is to maximize solar gains. In order to achieve it solar panels on the roof, panels in the windows and silver foil on the walls are used. It is said in “Rotating Homes” that rotation system as well as the other equipments cuts energy costs by at least 40%.

### **Evaluation of the examples:**

The similarities and differences of above-mentioned buildings can be described as follows,

- a) Except Zoltingen houses, all houses are circular or semi-circular in shape. Passive solar buildings work better where the envelope design controls the energy demand (solar orientation). Therefore, circular and semi-circular design of above mentioned buildings have some solar heating and cooling handicaps due to their shape.
- b) Johnstone’s house and Suite Vollard are surrounded by large windows. Therefore, it is not easy to control heat gain and heat loss in these buildings. On the other hand, Sunspace homes, Galileo House and Zoltingen houses are not surrounded by windows so with good insulation measures heat gain and loss can be controlled to some extent.
- c) Apart from Zoltingen houses, the basic construction principle of the buildings is to maximize the view. For Sunspace homes, making the buildings more energy efficient is the secondary purpose of construction which is the starting point of Zoltingen houses.
- d) Passive solar system utilized in Sunspace and Zoltingen houses is only direct gain systems.
- e) All of the buildings have different rotation mechanisms and various rotation speeds. If wanted, they can follow the sun all day long. In fact, operating rotation system needs electrical energy and continuous chasing of the sun costs a sum of money. Therefore, the efficiency of solar gains is debatable with regards to electricity consumption for these buildings.



## CHAPTER 4

### SOLAR BUILDING AT IYTE, URLA

As it is seen in the plans, our solar building has been designed according to the passive solar house design criteria. Other considerations while planning IYTE Cafe are;

- The building will be facing the south during winter period, from October 1<sup>st</sup> till April 30<sup>th</sup>, and it will be facing the north during summer period, from May 1<sup>st</sup> till September 30<sup>th</sup>. The aim of rotating the building two times a year is to maximize solar heat gain in summer while minimizing it in winter period.
- The building has been designed to be square in shape. In spite of the fact that buildings elongated along east and west axis provide more exposure to sun, addition of a sunspace to the building increases exposure to sun as well. Another reason for not designing the building rectangular is that it would require more area for rotation.
- During winter period the building needs maximum energy. Therefore, in order to supply optimum solar energy for the building in this period, one side of the building as well as a part of neighbouring sides have been surrounded by a sunspace.
- A clerestory responding some of ventilation and lighting need of the building have been structured on the terrace of the building.
- To reduce lighting costs and increase the availability of natural lighting, glass brick applications have been done on all sides of the building. Glass brick application also improves the aesthetic design of the building.
- The site is suitable for the location of the passive solar building since there are not high buildings which can overshadow it. The site views the sea and it is near to the faculties. These are advantageous conditions for a cafe.

Figure 4. 1. shows the paths of the sun for in their projected forms for İzmir (for the latitude of 38,24). For summer, in the time of sunrise and sunset, the sun has the azimuth angle of about  $120^0$ , and it has altitude angle of  $74^0$  in section. For winter, in the time of sunrise and sunset, the sun has the azimuth angle of  $60^0$ , and it has altitude angle of  $28^0$  in section. These are the critical angles to be considered in a building design in terms of thermal condition. Our building has been located according to these criteria.

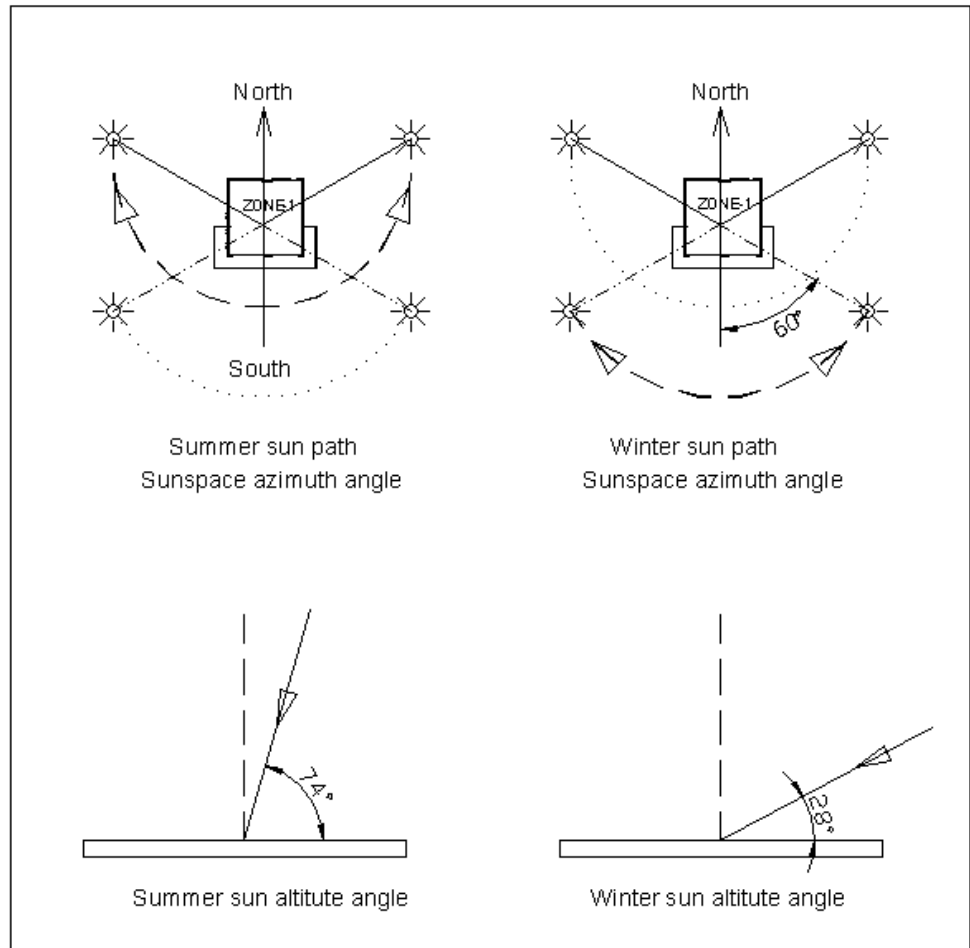

Figure 4. 1. The paths of the sun for summer and winter in our projected forms for İzmir

## **4. 1 Building Components**

### **4. 1. 1. Insulation Materials**

Insulation is a very important factor in passive solar systems. Insulation measures provide the best storage of heat gain from solar radiation. At the same time, during summer period, insulation partially protects the building from overheating. Therefore, the average heating need of the building can be reduced with good insulation precautions. As a result of these, the efficiency of the solar house can be increased.

IYTE Cafe loses heat from the floor, terrace and all sides except the one which is surrounded by the sunspace. For that reason, different insulation materials have been utilized for the insulation of the walls, floor and roof. Expanded polystyrene boards have been used for wall and floor insulation whereas glass wool is the insulation element of the roof.

Heat loss through the parts that are in the sunspace is assumed to be zero since temperature in the sunspace is always higher than the temperature of living space during the day. Therefore, having a low heat transfer coefficient, aerated concrete has been preferred as wall material of all walls since it provides good thermal protection. Another purpose of using aerated concrete is that it is a light material and it is easy to rotate a light building. Our building has a rotation system so the lighter the building the better.

### **4. 1. 2. Wall Components**

The following criteria have been taken into consideration while determining the wall material.

- Heat transfer coefficient of the material
- Heat absorption and storage capacity of the material
- Material's weight per volume
- The safety of the building against earthquakes

Aerated concrete (Ytong) has been chosen as the wall material.

Average Pressure Endurance:  $\text{kgf/cm}^2$ : 50

Weight per volume when it is dry:  $\text{kg/m}^3$ : 600

Weight of the wall after the static calculation:  $\text{kg/m}^3$ : 800 (with plaster)

Heat insulation coefficient (W/mh): 0,19

Thickness (cm): 15

For wall insulation, 3 cm expanded polystyrene boards have been used. The reason for utilising expanded polystyrene board instead of glass wool as an insulation material is that glass wool applications can be done between two walls. Construction of two walls increases the weight and also it decreases the volume of the living space and this is undesired in our project.

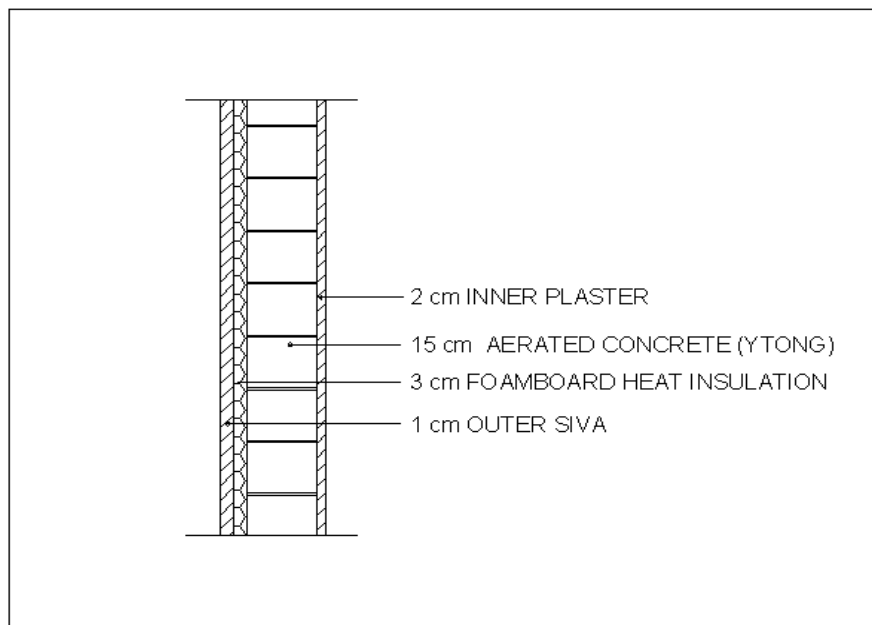

Figure 4. 2. Section of wall

### 4. 1. 3. Ceiling Components

The ceiling will be build up of reinforced concrete upon trapeze steel sheet. 15 cm glass wool has been utilised below the ceiling. The roof is preferred to be terrace. When all of ceiling components are taken into consideration heat transfer value has been calculated to be 0,31 W/mC. The calculation results can be seen in Appendix Table A-2.

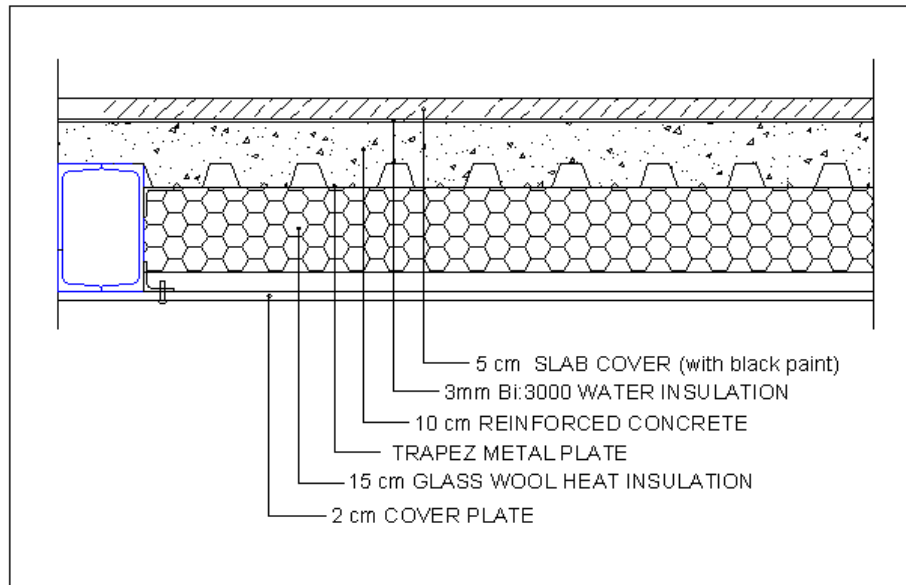

Figure 4. 3. Section of ceiling

The roof has been projected to be made of metal roofing material to reduce cooling and heating loads. Metal roofing products, as pointed out in “Metal Roofing”, have attractive solar reflectance and infrared emittance properties, depending on the choice of colour. Therefore, metal roofing helps lowering cooling and heating energy usage and lowering peak energy demand in buildings. It is claimed in EPA’s Energy Star Roof Products that reflective metal roofs can save up to 40% cooling energy on homes and buildings. In addition, a programme conducted by Florida Power and Light has shown that painted metal roof could save a homeowner about 23% annually in cooling costs compared to a dark coloured traditional shingle roof.

#### 4. 1. 4. Floor Components

The floor of IYTE Cafe consists of ironed concrete upon trapeze sheet. Expanded polystyrene board - 5cm thick – have been used as an insulation material since it is a hard material. Heat conductivity coefficient of expanded polystyrene board is 0,052 W/mK. (Adapted from TS 825)

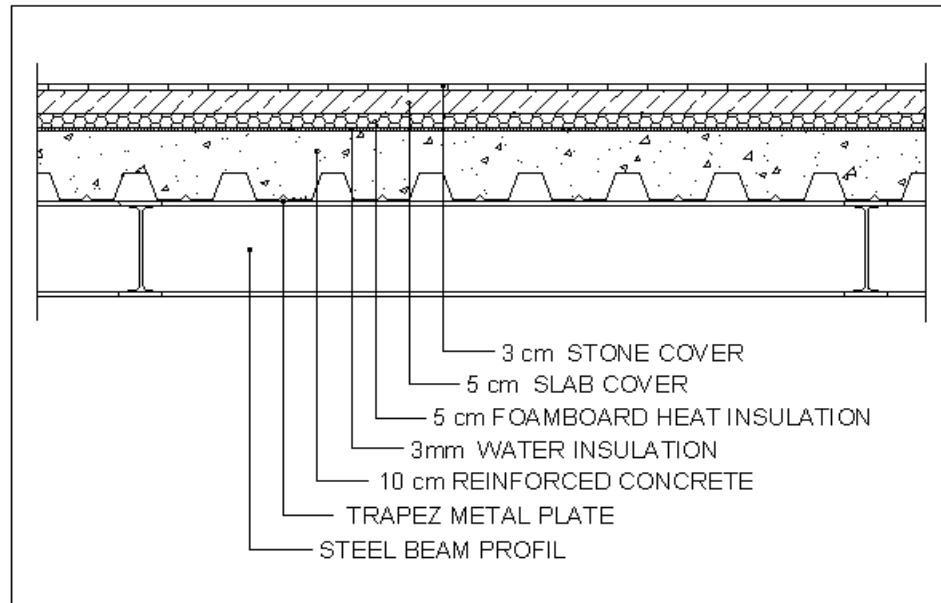

Figure 4. 4. Section of floor

#### 4. 1. 5. Window Components

The energy efficiency of windows is usually represented with their U-values (heat conductivity) or their R-values (resistance to heat flow). High R-value indicates less heat loss. There are some factors that affect the U-value or R-value of a window.

- The type of the glazing material (whether it is glass, plastic, etc.)
- The number of layers of glass (double, triple)
- The size of the air space between the layers of the glazing
- The thermal resistance or conductance of the frame and spacer materials
- The air tightness of the installation.

Current standards set by American Society of Heating, Refrigeration, and Air-Conditioning Engineers (ASHRAE) are shown in Appendix Table. A-1

As it is seen in the table, standard single-pane glass has very little insulating value. It supplies only a thin barrier to outside. Double- or triple-pane windows have insulating air- or gas-filled spaces between each pane. The width of the air space between the panes is important as well. In our project, double glazed with 12 mm gap glazing has been used (ASHRAE 2001). Heat conductivity coefficient of glazing is 3,51 W/m<sup>20</sup>C.

In the project, a clerestory window has been designed to provide natural light for the far end of the cafe although in summer some amount of heat is gained through it. Therefore, for the clerestory window low-emissivity (low-e) glazing has been preferred since it reflects some of the heat that is normally transmitted through clear glass, while allowing the full amount of light to pass through.

Window frames are available in a variety of materials. Although aluminum conducts heat and therefore loses heat faster, it is a popular framing material because it is inexpensive, durable and easy to manufacture and does not rot or absorb water like wood but thermal resistance of aluminium frames can be improved by placing continuous insulating plastic strips between the interior and exterior of the frame. In our project aluminum frames with insulating thermal break have been utilized. (ASHREA 2001, Çengel 1998)

Table 4. 1. Heat transfer coefficients of selected building components

<b>Material</b>	<b>Dry Volume Mass- kg</b>	<b>U-Factors Value-W/m<sup>2</sup>.C</b>	<b>Resource</b>
Aerated Concrete, Ytong	600	0,19	TS-825, catalogue
Double Glazed, 12mm gap with aluminum frame	-	3,51	ASHRAE
Double glass door with aluminum frame	-	4,18	ASHRAE
Glass Brick	-	2,8	Lara firm
Ironed Concrete	2400	2,1	TS-825
Concrete without iron	2200	1,74	TS-825
Alum	200	1,4	TS-825
Glass Wool	100-500	0,052	TS-825
Expanded polystyrene board	30	0,035	TS-825
Plaster coated ceiling	900	0,21	TS-825
Sunspace insulated metal roofing		0,63	Park Panel, catalogue
Low-e double glazing window 12 mm gap		2,67	ASHREA



## 4. 2. Sunspace Design

IYTE Cafe has an attached sunspace with vertical glazing. Its roof is shaded to protect the space from overheating. The sunspace has been designed to cover some part of east and west walls of the building though it is not recommended very much. The purpose of including some part of east and west walls into the sunspace is that in winter period it increases heat gain. On the other hand, in summer position when the sunspace faces the north, it provides more lightening for the cafe because at this position the south-facing side of the building has the minimum glazing. Added shading on the east and west side of the sunspace can be operated in hot summer day in order to prevent overheating.

The wall between the sunspace and the living space has been designed to be glazing because it is an aesthetic design for a building which serves as a cafe. Glazing also improves the natural lighting for the living space. The glazed wall transmits direct solar radiation, especially with low angle winter sun which can penetrate into the building, after passing through the sunspace. In addition, glazed wall transforms sunspaces into more elaborate direct gain systems, where the main solar gain is received directly into the dwelling space. This is desired for our project since the sunspace will be facing the south in winter. This design seems to be disadvantageous on the basis of night heat losses but the cafe does not work after midnight. Therefore, night heat loss can be omitted for heat gain during winter days.

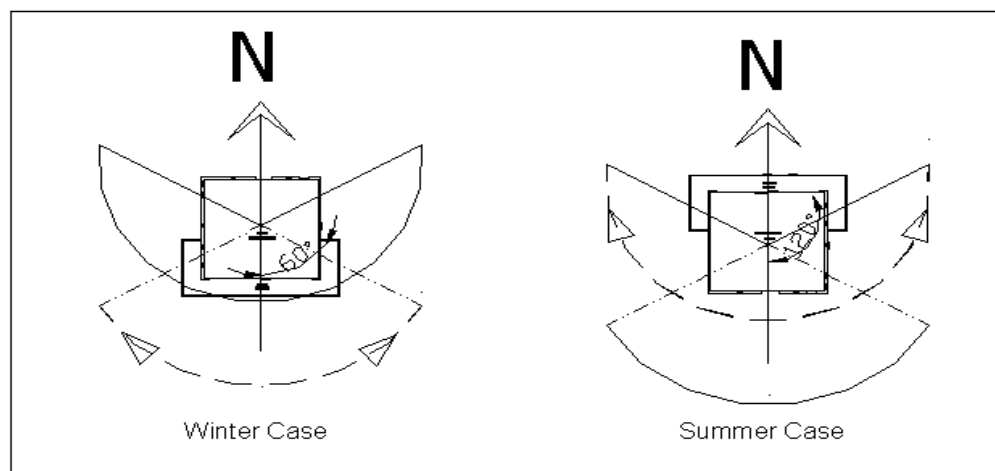

Figure 4. 5. IYTE Cafe sunspace design according to summer and winter sun paths

### 4. 3. Ventilation System Design

Passive cooling of buildings is as important as passive heating. Natural ventilation is the preferred passive cooling method in this project. Although rotation function of the building eliminates excessive heat gains in summer, the cafe will still have a cooling load that must be eliminated with ventilave cooling. Ventilative cooling is exhausting warm building air and replacing it with cooler outside air.

Rules of thumb for ventilative cooling are (Moore 1993);

- Careful design of building configuration on the site and the surrounding spaces,
- Layout of internal spaces,
- Distribution of openings –windows, doors- on the building facade,
- Wind speed and its direction in the building site,
- Other buildings and plants surrounding the building (if exists),
- Type of windows utilized,

IYTE Cafe has been designed according to these principles. Windows have been positioned in opposite directions of the sunspace to produce cross ventilation. The operable clerestory window has been also projected to help ventilate cooling. Window sizes and types have been determined by using a simplified worksheet procedure developed by The Florida Solar Energy Centre (Moore 1993). Besides, exhaust ventilation system will be utilized for kitchen and toilet ventilation. All of the vents will be controlled either manually or automatically.

Natural ventilation can perform well but it requires relatively large vent openings. Vents should be sized to prevent overheating under worst conditions. Depending on the design of the solar sunspace, these conditions will occur in late summer if the sunspace roof is glazed and there is little shading or fall if there is vertical glazing and overhang shading. The necessary size of the vents is a function of a number of factors, including available shading, the tilt of the glazing, the size of the glazing relative to the size of the sunspace, the vertical separation between the vents, and the increase over outdoor temperatures that is to be accepted in the space.

The inlet vents should be low and the exhaust vents high. The vertical separation between high and low vents helps determine the airflow. More separation is better. Table 4. 2 suggests minimum rule of thumb vent areas as a proportion of glazing area for four different stack heights. The sunspace of IYTE Cafe has a vertical glazing. There is a potential temperature difference between the outdoor and the sunspace which is 10°C in our project. Total glazing area of the sunspace is the sum of 21 m<sup>2</sup> window area and 3, 3 m<sup>2</sup> glazed door area.

Total vent area = 24, 3 . 0, 07 = 1, 70 m<sup>2</sup> (low and high vents altogether)

1, 70 / 2 = 0, 85 m<sup>2</sup> high vent, 0, 85 m<sup>2</sup> low vent

Eight vents having an area of 0, 20 m<sup>2</sup> (20 cm x 100 cm) have been determined to be projected. Depending on indoor temperature, controlling mechanism of the vents - manual or automatic- will be decided later.

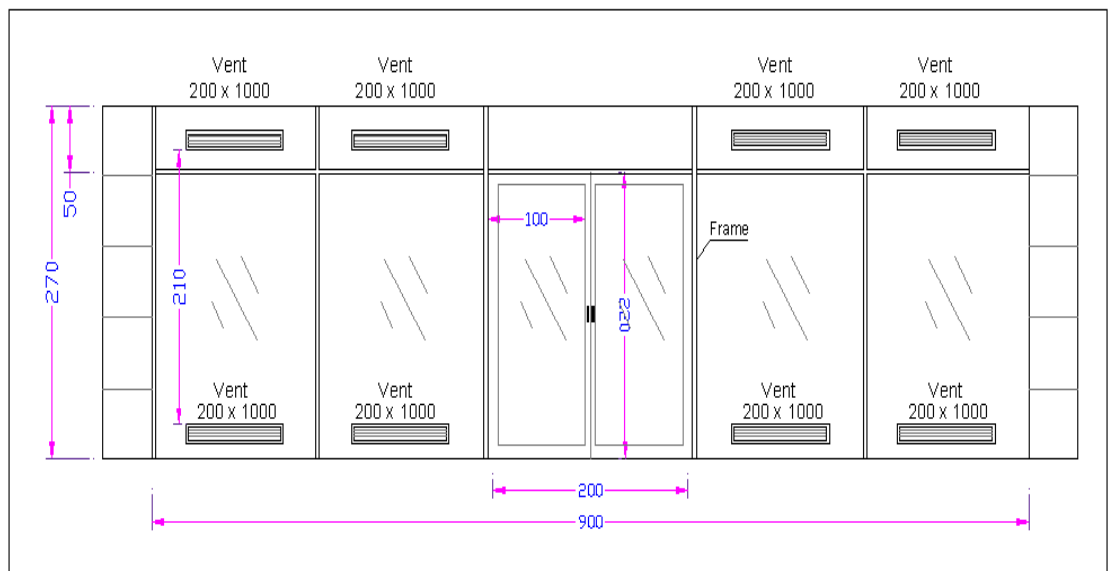

Figure 4. 6. Vents on the common wall between the living space and the sunspace

Table 4. 2. Exterior vent areas (McFarland and Jones Solar Age 6/84)

Allowable Sunspace Temperature Over Outside Air °F	Minimum Vent-Pair Area (as % of Glazing Area) for Given Vertical Separation (Between Upper and Lower Vents)				Equivalent Fan Capacity - cgfm/Ft <sup>2</sup> of Glazing Area
	4'	8'	12'	16'	
<b>Vertical Glazing</b>					
5	31	22	18	16	12
10	10	7	6	5	5.6
15	5	4	3	3	3.5
<b>60° Tilt</b>					
5	40	28	23	20	15.2
10	13	9	8	7	7.1
15	7	5	4	3	4.4



Figure 4. 7. Example vent with damper

## 5. 4. Rotation System Design

Before determining the rotation equipments, the building has been investigated statically to find out whether it is suitable for rotation. It is found that the building is strong enough for rotation.

After the research of systems that could be practical and useful for rotating our building, crane rail system has been found appropriate for the rotation system of IYTE Cafe. The working principle of crane systems depends on constituting torque within the same axis. In order to lessen the load upon each crane, eight crane wheels has been installed. Another reason of utilization of eight wheels rather than fewer wheels is that rotation movement is started and maintained with less power.

Motor calculations have shown that two 1, 5 kW-reducers connected to two cranes will be enough for rotation. The building is assumed to rotate with the speed of 0, 01 m/sec. Therefore, the building finishes one 180<sup>0</sup> rotation in about 24 minutes.

Static analysis of the building, the analysis of load on each wheel, the analysis of earthquake load and the analysis of linear and vertical loads have been done with Sab2000 computer programme. Static analysis of load distribution of the building and earthquake loads can be seen in Appendix B.

Building loads have been used to find out the appropriate motor power for the rotation system. Computer programme of Yılmaz Redüktör firm has been utilized to determine motor power. To sum up, results and assumptions of the rotation system are;

- Motor speed: 0,01 m/sec.
- Vertical load on a crane wheel: 30 tonnes.
- The weight of the building: 240 tonnes (earthquake and people load are not included)
- Motor power : 2 x 1,5 kW ( two motors chosen )

Electrical and mechanical systems including, graywater system, electrical and telephone systems will be distributed to the cafe from the centre the building. A drainage hole will be opened in the centre of the base to connect the graywater system

to the sewer lines. Flexible 100 mm drainage flexpipe will be used as a connection material. With connection fittings, all connections on the graywater system will be sealed.

Pure water system pipes will be flexible too but more pipes will be required to protect from tearing loose from their mains during rotation. Pure water and graywater systems will be fitted to iron joists with pipe-clips to reach the kitchen and the toilets. Most of the pipes will not be installed in building materials so if any defect occurs, it will be easier to mend it.

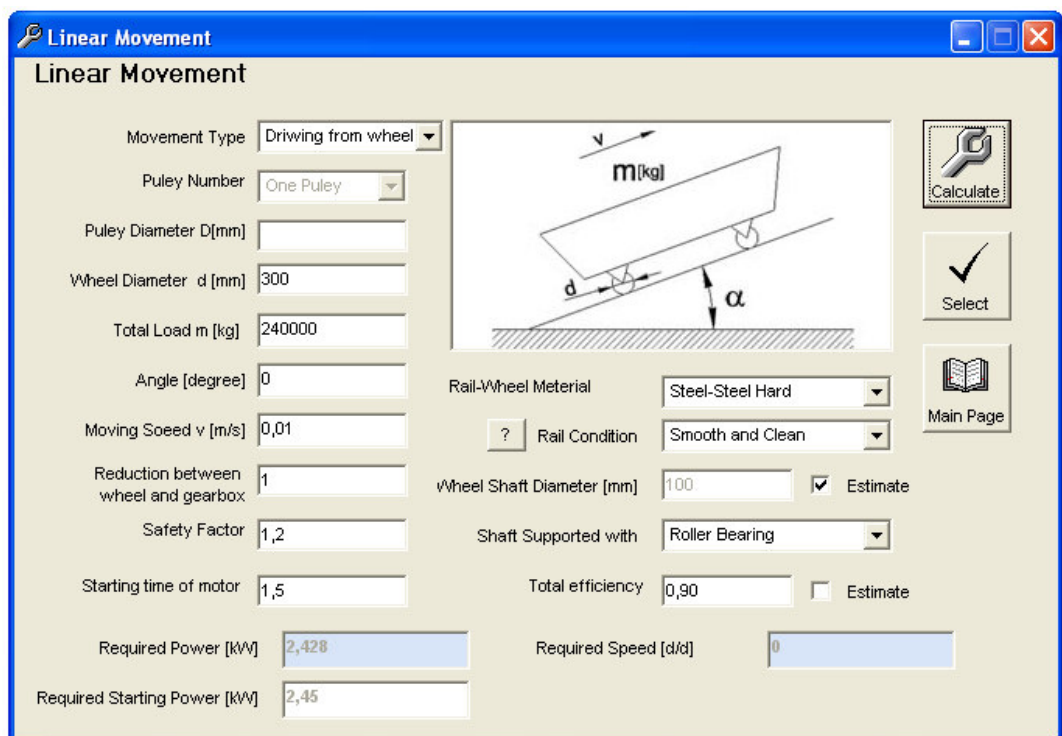

Figure 4. 8. Computer-aided reducer design

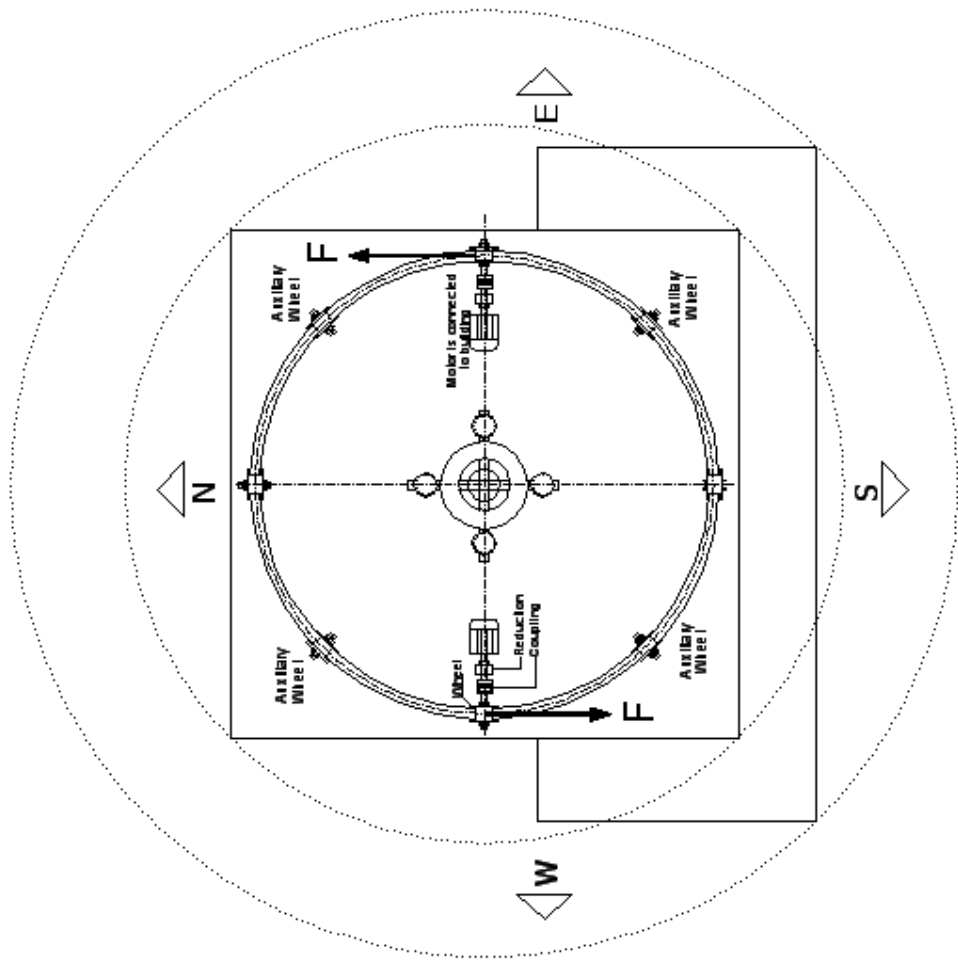

Figure 4.9. IYTE Cafe Rotating System

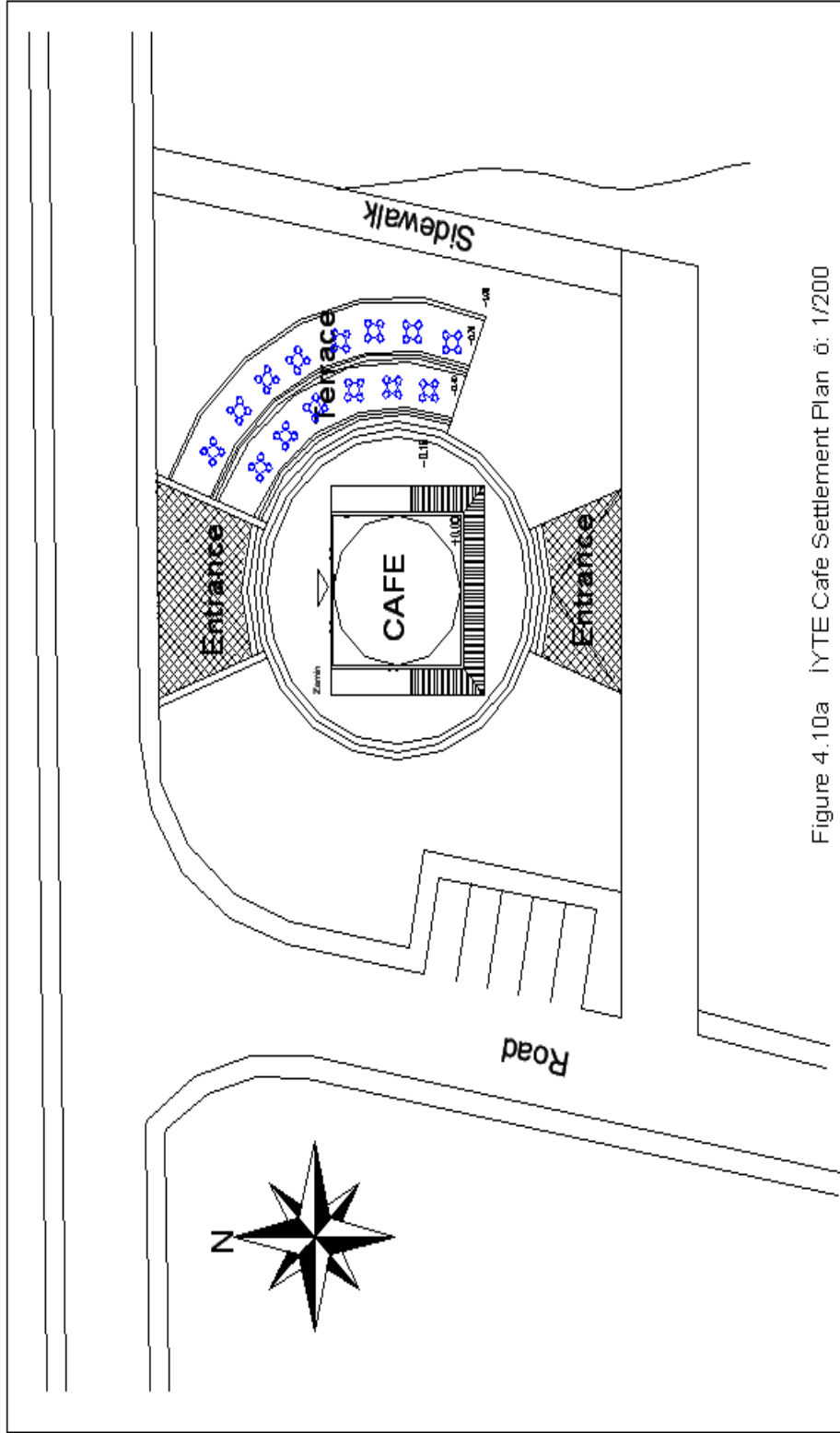

Figure 4.10a IYTE Cafe Settlement Plan ó: 1/200



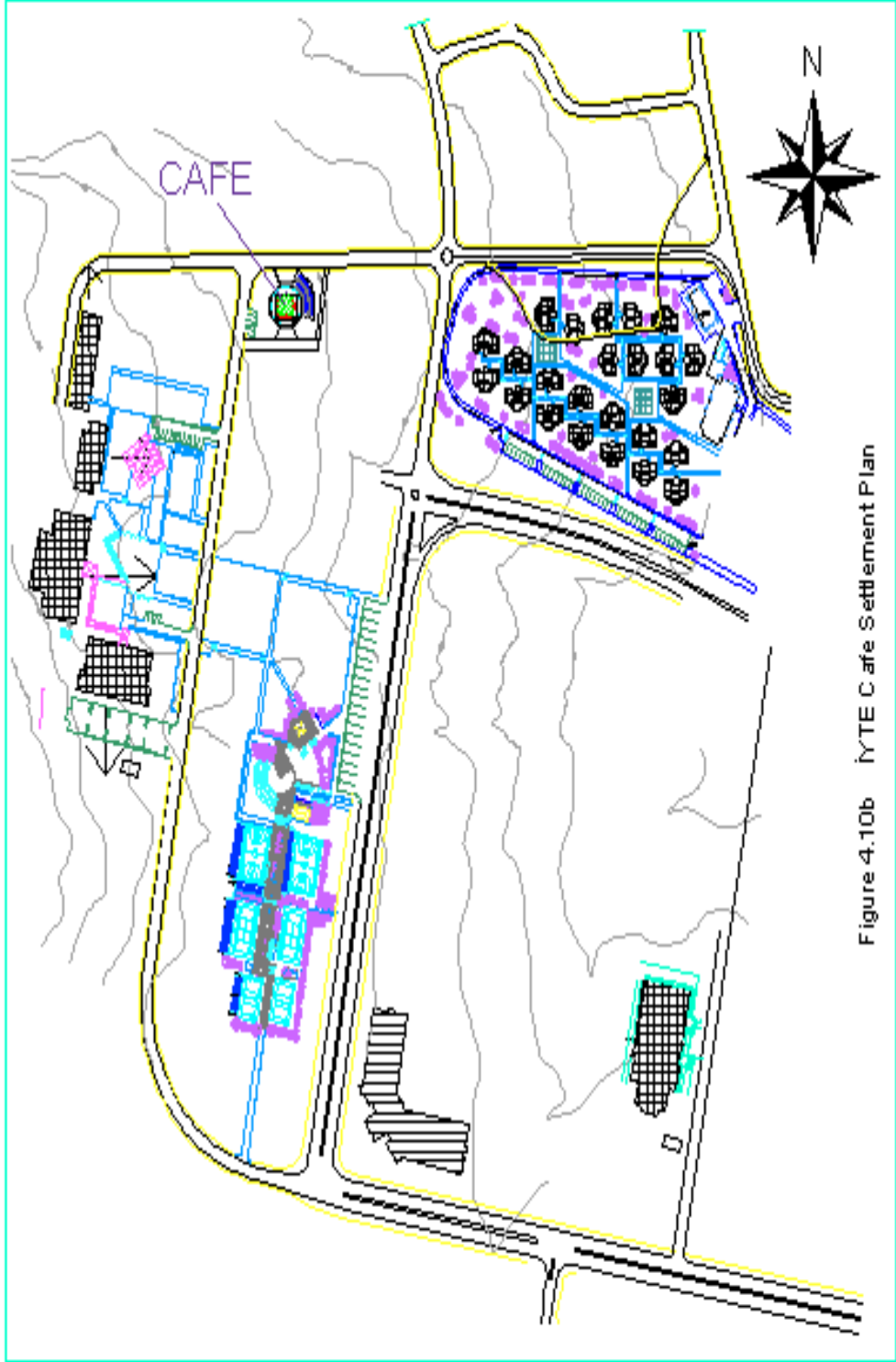

Figure 4.10b IYTE Cafe Settlement Plan

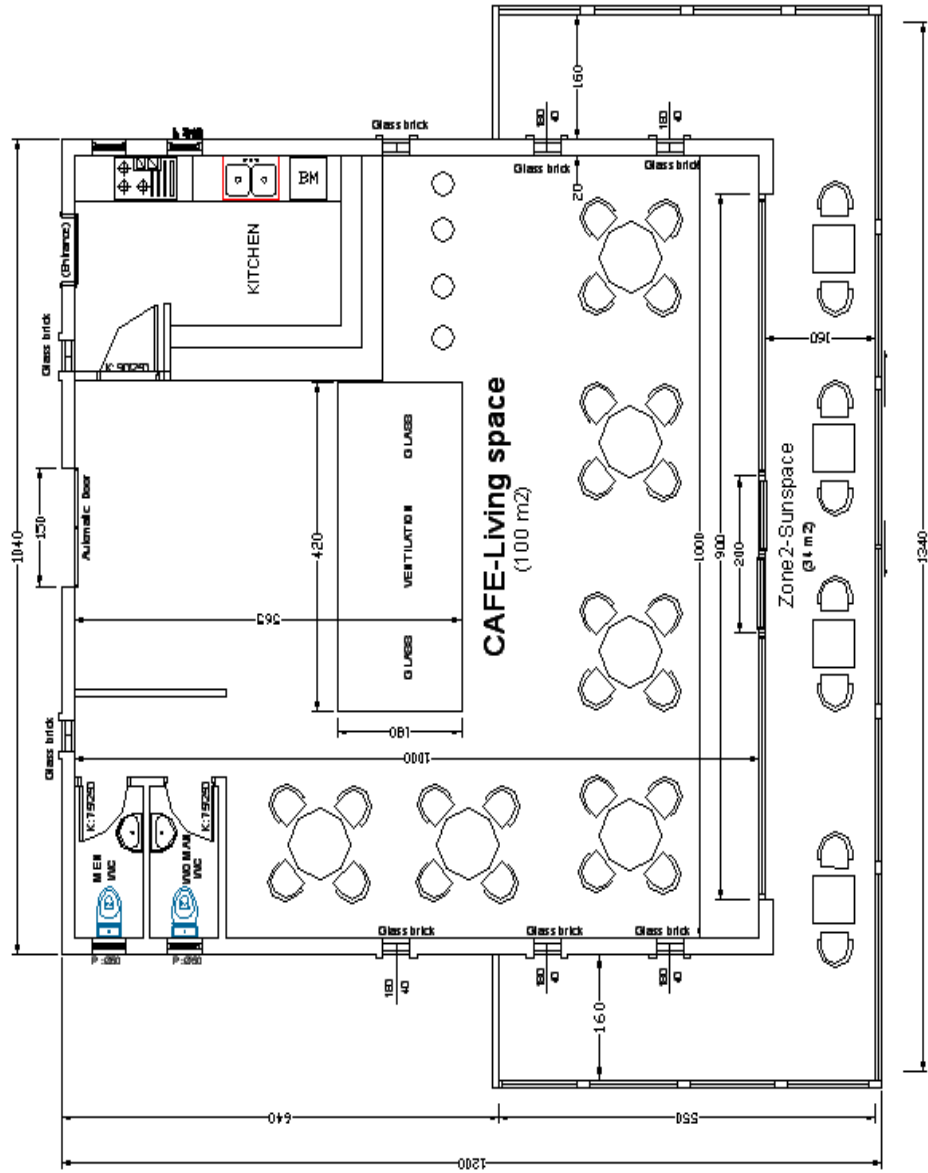

Figure 4.11 IYTE Cafe Plan





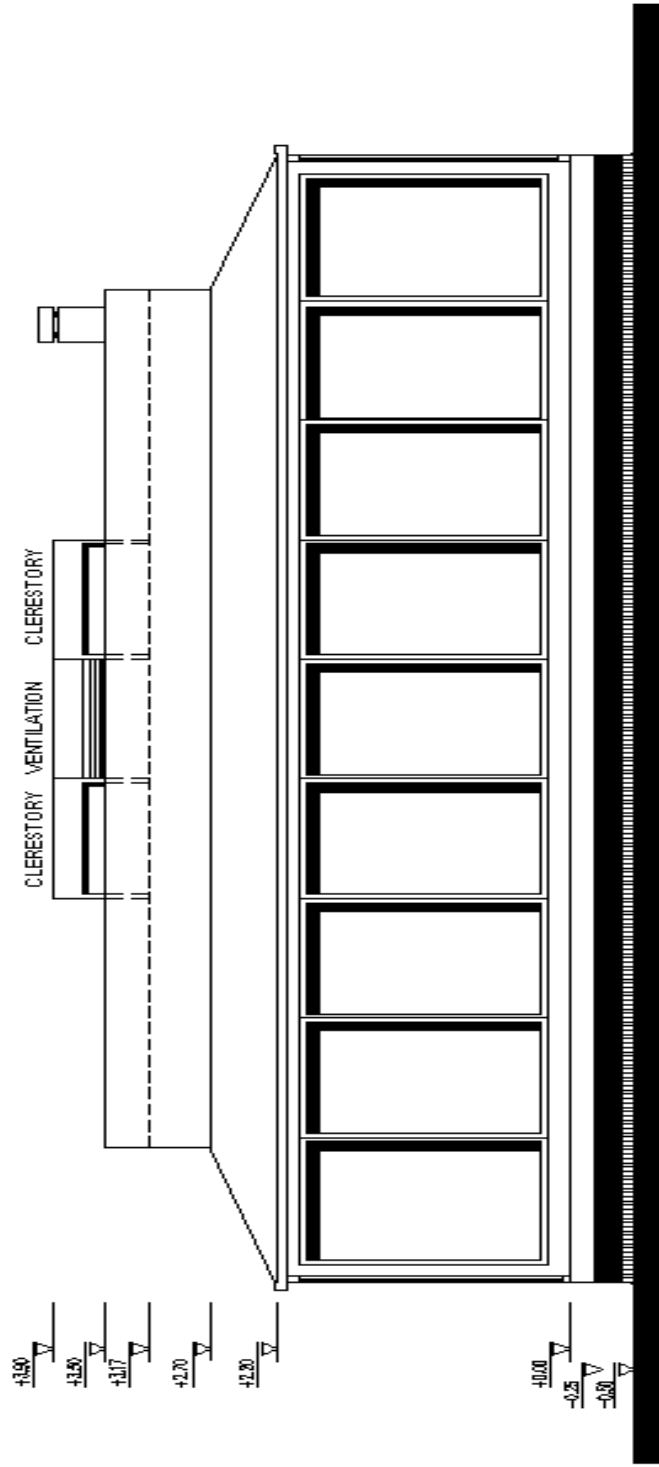

Figure 4.14 IYTE Cafe South View

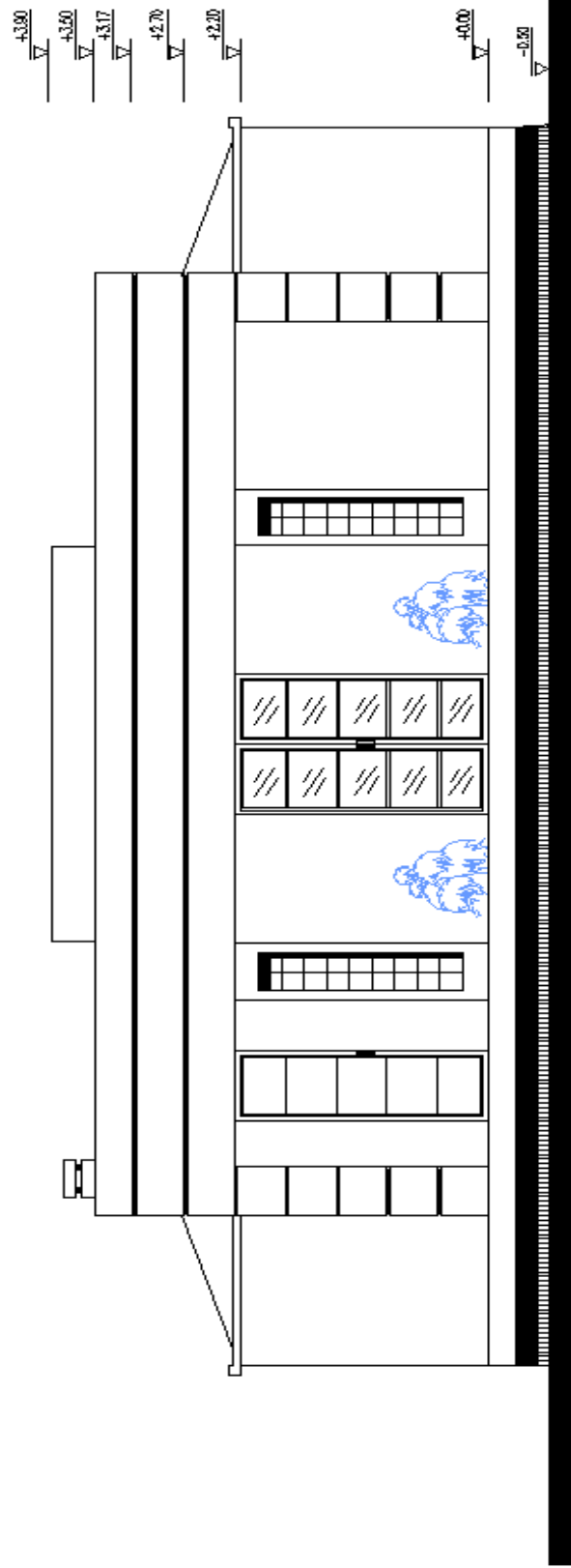

Figure 4.15 | YTE Cafe North View

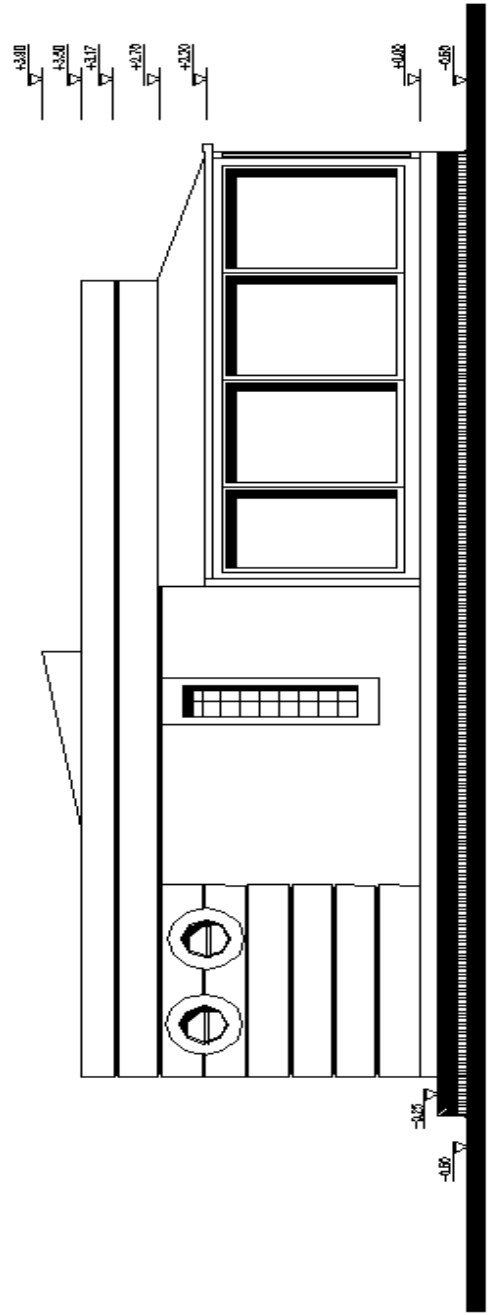

Figure 4.16 IYTE Cafe West View

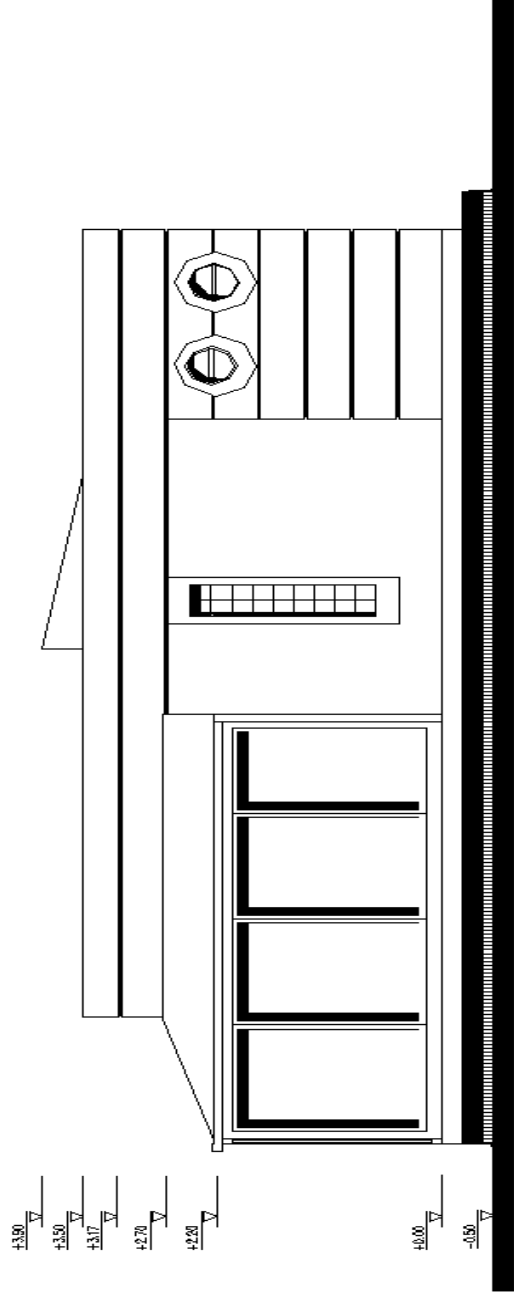

Figure 4.17 YTE Cafe East View



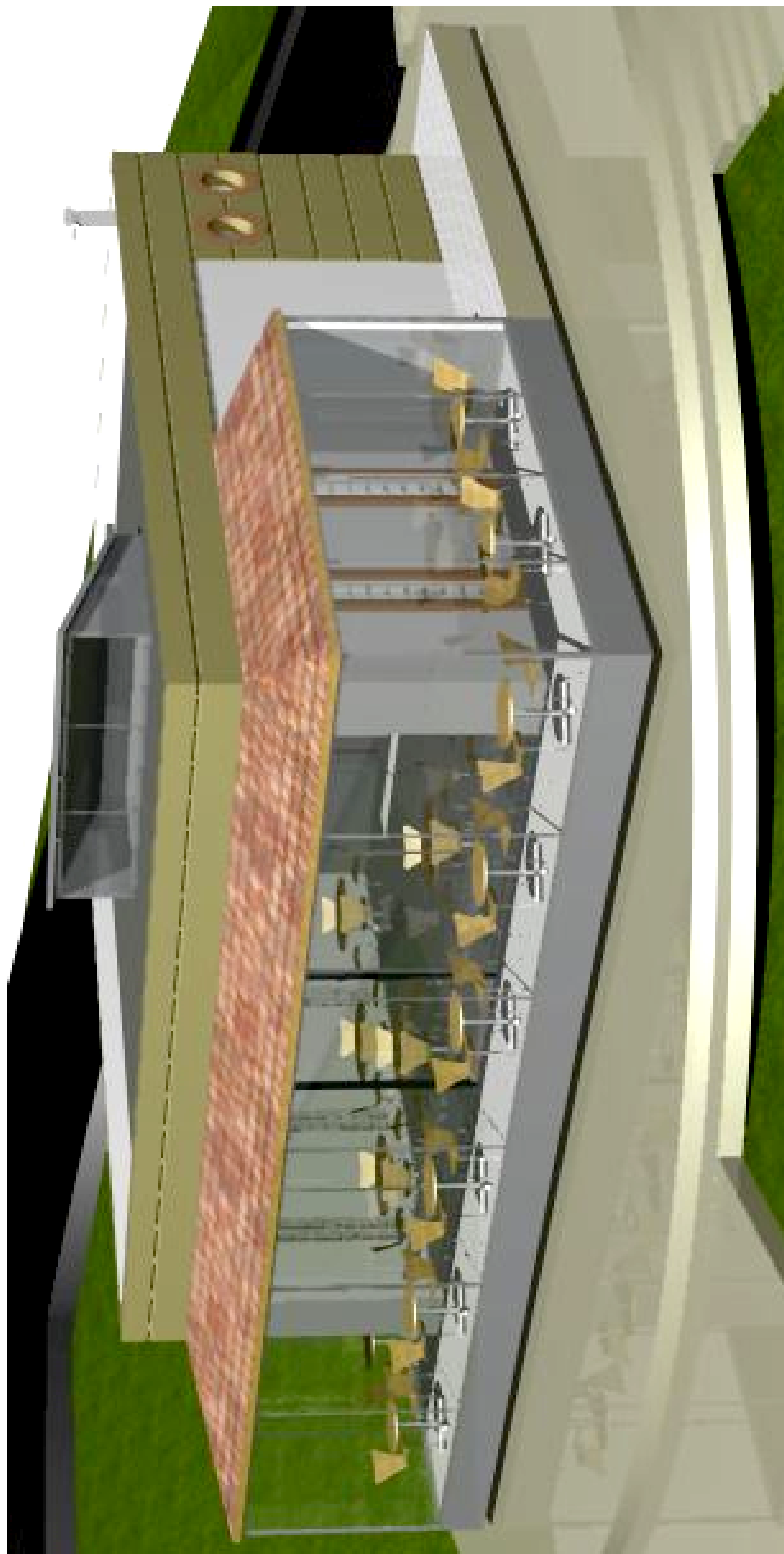

Figure 4.18 3-D South View



Figure 4.19 3-D Settlement View

## CHAPTER 5

### CALCULATION METHODS

In this chapter, the required calculations for our project, IYTE Cafe, will be done so as to gather qualified information about the effectiveness of the rotation system on heating, cooling and ventilation of a passive solar house. These calculations will be done according to two major seasonal periods, winter and summer, upon which the cafe will be rotated. As the cafe is constructed of passive heating principles, the first section of this chapter will be devoted to solar calculations.

#### 5. 1. Solar Calculation

The major heating resource of IYTE Cafe is the solar energy so solar radiation is the basic interest in solar calculations. Beam radiation is the solar radiation received from the sun without having been scattered by the atmospheric processes such as clouds. It is often referred to as direct solar radiation. Diffuse radiation is the solar radiation received from the sun after its direction has been changed by scattering by atmospheric components such as particles, water vapour and aerosols (Duffie and Beckman 1991). As shown in figure 5.1, reflected radiation is either diffuse or beam radiation reflected from the foreground onto the solar aperture. Calculation of these three types of solar radiation is very important in determining the efficiency of solar resource for heating and cooling. Radiation incident on a surface that does not have a direct view of the sun consists of diffuse and reflected radiation. Therefore, at solar noon, solar radiations incident on the east, west and north surfaces of a south-facing house are identical since they all consist of diffuse and reflected components (Çengel 1998).

Solar calculations are quite complex and have different aspects to consider. Therefore, in order to examine them in detail, they will be studied under separate sections.

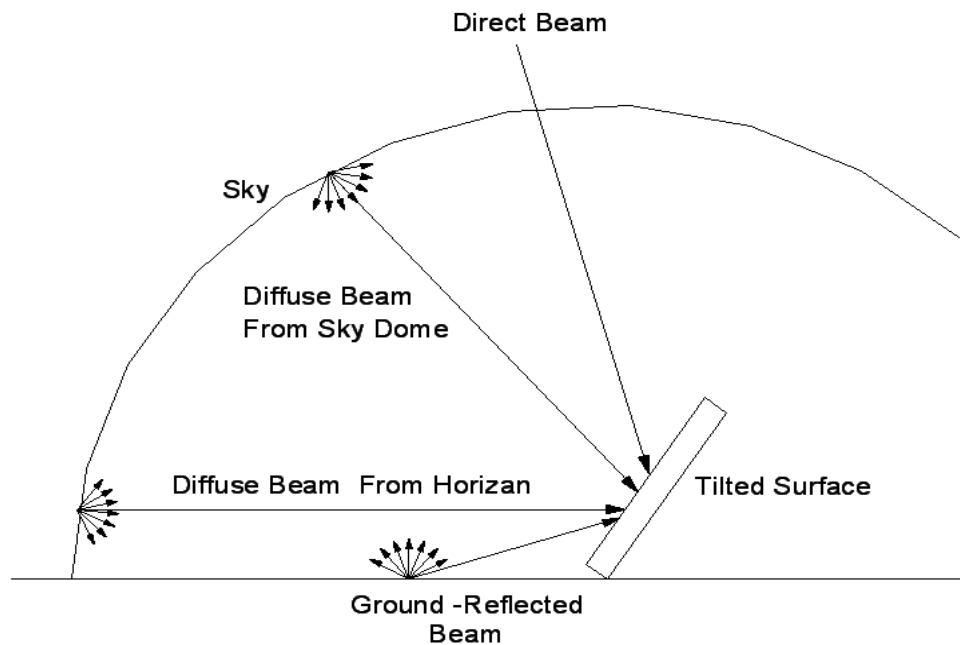

Figure 5. 1. Direct, Diffuse and ground-reflected radiation on a tilted surface (modified from Duffie and Beckman 1991)

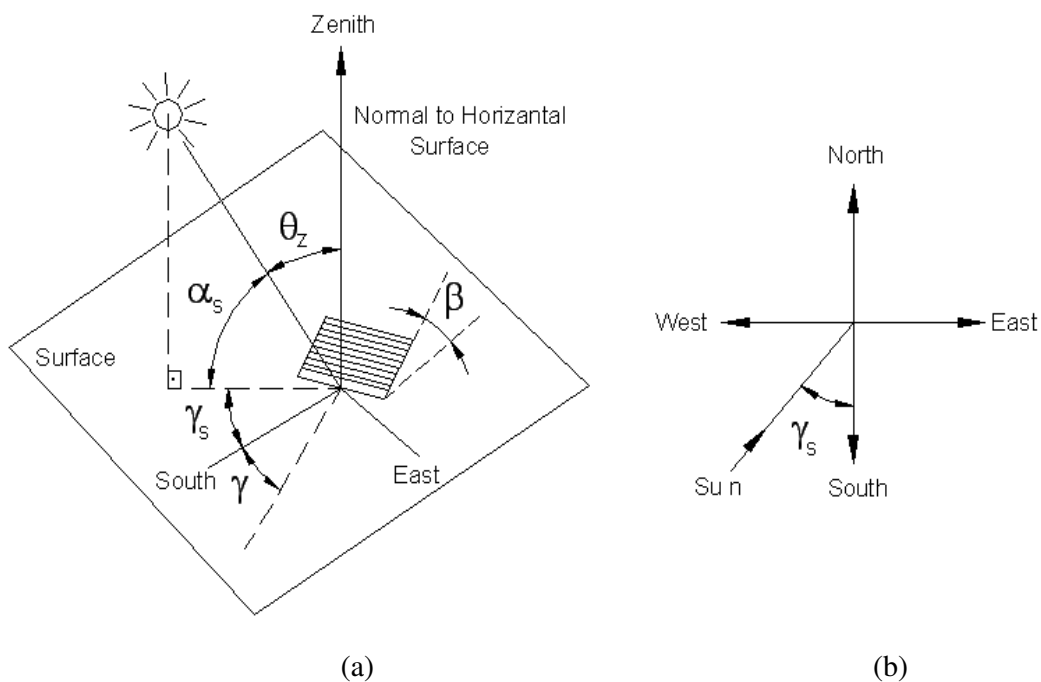

Figure 5. 2. (a) Zenith angle, slope, surface azimuth angle, and solar azimuth angle for a tilted surface. (b) Plan view showing solar azimuth angle (modified from Duffie and Beckman 1991)

### 5.1.1. Solar Radiation Angles

The geometric relationships between a plane of any particular orientation relative to the earth at any time and the incoming beam solar radiation, that is the position of the sun relative to that plane, can be described in terms of several angles and are shown in figure 5.2 (Duffie and Beckman 1991) .

$\phi$  : **Latitude**, the angular location north or south of the equator, north positive;  $-90^{\circ} \leq \phi \leq 90^{\circ}$  .

$\delta$  : **Declination**, the angular position of the sun at solar noon with respect to the plane of the equator, north positive;  $-23,45^{\circ} \leq \delta \leq 23,45^{\circ}$  .

$\beta$  : **Slope**, the angle between the plane of the surface in question and the horizontal;  $0 \leq \beta \leq 180^{\circ}$  . ( $\beta > 90^{\circ}$  means that the surface has a downward facing component.)

$\gamma$  : **Surface azimuth angle**, the deviation of the projection on a horizontal plane of the normal to the surface from the local meridian, with zero due south, east negative, and west positive;  $-180^{\circ} \leq \gamma \leq 180^{\circ}$

$\omega$  : **Hour angle**, the angular displacement of the sun east or west of the local meridian due to rotation of the earth on its axis at  $15^{\circ}$  per hour, morning negative, afternoon positive.

$\theta$  : **Angle of incidence**, the angle between the beam radiation on a surface and the normal to that surface.

$\theta_z$  : **Zenith angle**, the angle between the vertical and the line to the sun, i.e., the angle of incidence beam radiation on a horizontal surface.

$\alpha_s$  : **Solar altitude angle**, the angle between the horizontal and the line to the sun, i.e., the complement of the zenith angle.

$\gamma_s$  : **Solar azimuth angle**, the angular displacement from south of the projection of beam radiation on the horizontal plane. Displacements east of south are negative and west of south are positive.

## 5. 1. 2. Beam Radiation Acting on a Tilted Surface

Solar radiation at a time and a place inside the atmosphere depends on the slope and direction of the surface. Maximum solar gain is captured on surfaces where solar radiation comes with right angle. This requires the investigation of the sun on horizontal and vertical axis. In some cases, investigation of the sun on a single axis (North-south, west-east, horizontal, tilted, polar etc.) may provide obtaining more solar energy from the system. However, this method is rather expensive and there are some cheaper systems. Therefore, optimum direction (orientation) method is preferred for fixed surfaces (Lunde 1980).

System designers need solar radiation values of fixed, tilted and solar azimuth angle surfaces for their applications. Generally it is easy to find out the data for measured and estimated radiation on normal direction or for horizontal surfaces. These radiation data must be formulated for tilted surfaces (Source:WEB\_17, 2005) .

It is easy to formulate beam radiation data for tilted surfaces.

For horizontal surfaces,

$$\cos \theta_z = \frac{H_b}{H_{bt}} \quad (5. 1)$$

For tilted surfaces,

$$\cos \theta = \frac{H_{bt}}{H_{bn}} \quad (5. 2)$$

$H_{bn}$  = Beam radiation at normal incidence

$H_b$  = Beam radiation on horizontal surface

$H_{bt}$  = Beam radiation on tilted surface

From these two equations, the geometric factor  $R_b$ , the ratio of beam radiation on the tilted surface to that on the horizontal surface at any time, can be calculated.

$$R_b = \frac{H_{bt}}{H_b} = \frac{\cos \theta}{\cos \theta_z} \quad (5. 3)$$

If  $R_b$  factor is known, then beam radiation on the surface can be calculated with the following formula;

$$H_{bt} = H_b \times R_b \quad (5.4)$$

If the surface faces the south, then  $R_B$  factor at any time is,

$$R_b = \frac{\cos \theta_T}{\cos \theta_Z} = \frac{\cos(\phi - \beta) \cdot \cos \delta \cdot \cos \omega + \sin(\phi - \beta) \cdot \sin \delta}{\cos \phi \cdot \cos \delta \cdot \cos \omega + \sin \phi \cdot \sin \delta} \quad (5.5)$$

The equation for diffuse radiation from the sky dome for surfaces with  $\beta$  slope is,

$$H_d \cdot \frac{(1 + \cos \beta)}{2} \quad (5.6)$$

where  $H_d$  is the diffuse radiation on horizontal surface (Duffie and Beckman 1991).

Tilted surfaces also receive reflected radiation from the ground and other substances. If reflection coefficient for reflected radiation that tilted surfaces receive is  $\rho$ , then the ratio of ground-reflected radiation to surfaces with slope  $\beta$  is,

$$\rho \cdot \left( \frac{1 - \cos \beta}{2} \right) \quad (5.7)$$

and ground-reflected radiation is,

$$(H_b + H_d) \cdot \rho \cdot \left( \frac{1 - \cos \beta}{2} \right) \quad (5.8)$$

The sum of beam, diffuse and reflected radiation gives total solar incidence radiation on a tilted surface;

$$H_t = H_b \cdot R_b + H_d \cdot \left( \frac{1 + \cos \beta}{2} \right) + (H_b + H_d) \cdot \rho \cdot \left( \frac{1 - \cos \beta}{2} \right) \quad (5.9)$$

where  $H = H_b + H_d$  gives the sum of beam and diffuse radiation on horizontal surfaces coming from the sky dome.

Different combined solar energy design systems have been developed to predict monthly average daily total radiation on tilted surfaces. One of these systems is developed by Liu and Jordan. This method uses a correlation derived from monthly average clearness index  $\bar{K}_T$  depending on the ratio of diffuse radiation to total solar radiation (Duffie and Beckman 1991).

For  $\omega_s \leq 81,4^\circ$  and  $0,3 \leq \bar{K}_T \leq 0,8$

$$\frac{\bar{H}_d}{H} = 1,391 - 3,560 \cdot \bar{K}_T + 4,189 \cdot \bar{K}_T^2 - 2,137 \cdot \bar{K}_T^3 \quad (5.10. a)$$

and for  $\omega_s > 81,4^\circ$  and  $0,3 \leq \bar{K}_T \leq 0,8$

$$\frac{\bar{H}_d}{H} = 1,311 - 3,022 \cdot \bar{K}_T + 3,427 \cdot \bar{K}_T^2 - 1,821 \cdot \bar{K}_T^3 \quad (5.10. b)$$

Here,  $\bar{H}_d$  is the monthly average diffuse radiation on horizontal surfaces.

Collares-Pereira and Rabl have defined the following equation for correlations which includes sunset hour angle,  $\omega_s$ , and monthly average clearness index,  $\bar{K}_T$ .

$$\frac{\bar{H}_d}{H} = 0,775 + 0,00653 (\omega_s - 90) - [0,505 + 0,00455 (\omega_s - 90)] \cdot \cos(115 \cdot \bar{K}_T - 103) \quad (5.11)$$

Klein extended the equation of Liu and Jordan to calculate monthly average daily radiation on tilted surfaces to be used in solar process design procedures. If the diffuse and ground-reflected radiation are assumed to be isotropic, then the monthly mean solar radiation on a tilted surface can be calculated with the following equation (Özbalta et al. 2004).

$$\bar{H}_T = \bar{H} \cdot \left( 1 - \frac{\bar{H}_d}{H} \right) \cdot \bar{R}_b + \bar{H}_d \cdot \left( \frac{1 + \cos \beta}{2} \right) + \bar{H} \cdot \rho \cdot \left( \frac{1 - \cos \beta}{2} \right) \quad (5.12)$$



$\bar{R}_b$  is the monthly average beam radiation factor and it is a complex function of atmospheric transmittance. Liu and Jordan have proved that this value can be predicted from the ratio of extraterrestrial radiation on a tilted surface to radiation on a horizontal surface for the month.  $\bar{R}_b$  factor for surfaces that are sloped toward the equator in the northern hemisphere can be calculated with the following equation (Çengel 1998).

$$\bar{R}_b = \frac{\cos(\phi - \beta) \cdot \cos \delta \cdot \sin \omega_{sst} + (\pi/180) \cdot \omega_{sst} \cdot \sin(\phi - \beta) \cdot \sin \delta}{\cos \phi \cdot \cos \delta \cdot \sin \omega_s + (\pi/180) \cdot \omega_s \cdot \sin \phi \cdot \sin \delta} \quad (5. 13)$$

Non-south-facing surfaces can be calculated with the below-given equation (Lunde 1980).

$$\bar{R}_b = \frac{\left[ \begin{aligned} &(\cos \beta \cdot \sin \delta \cdot \sin \phi) \cdot \frac{\pi}{180} \cdot (\omega_{sst} - \omega_{srt}) - (\sin \delta \cdot \cos \phi \cdot \sin \beta \cdot \cos \gamma) \cdot \frac{\pi}{180} \cdot (\omega_{sst} - \omega_{srt}) \\ &+ (\cos \phi \cdot \cos \delta \cdot \cos \beta) \cdot (\sin \omega_{sst} - \sin \omega_{srt}) + (\cos \delta \cdot \cos \gamma \cdot \sin \phi \cdot \sin \beta) \cdot \\ &(\sin \omega_{sst} - \sin \omega_{srt}) + (\cos \delta \cdot \sin \beta \cdot \sin \gamma) \cdot (\cos \omega_{sst} - \cos \omega_{srt}) \end{aligned} \right]}{\left[ 2 \left( \cos \phi \cdot \cos \delta \cdot \sin \omega_s + \frac{\pi}{180} \cdot \omega_s \cdot \sin \phi \cdot \sin \delta \right) \right]} \quad (5. 14)$$

Sunrise and sunset angles in equation 5. 14 can be calculated with the help of following equations (Lunde 1980).

If  $\lambda < 0$ ,

$$\omega_{srt} = -\min \left\{ \omega_s, \ar \cos \cdot \left[ \left( A \cdot B + \sqrt{A^2 - B^2 + 1} \right) / (A^2 + 1) \right] \right\} \quad (5. 15)$$

$$\omega_{sst} = \min \left\{ \omega_s, \ar \cos \cdot \left[ \left( A \cdot B - \sqrt{A^2 - B^2 + 1} \right) / (A^2 + 1) \right] \right\} \quad (5. 16)$$

If  $\lambda > 0$ ,

$$\omega_{srt} = -\min \left\{ \omega_s, \ar \cos \cdot \left[ \left( A \cdot B - \sqrt{A^2 - B^2 + 1} \right) / (A^2 + 1) \right] \right\} \quad (5. 17)$$

$$\omega_{sst} = \min \left\{ \omega_s, \ar \cos \cdot \left[ \left( A \cdot B + \sqrt{A^2 - B^2 + 1} \right) / (A^2 + 1) \right] \right\} \quad (5. 18)$$

where

$$A = \cos \phi \cdot (\sin \gamma \cdot \tan \beta) + \sin \phi / \tan \gamma \quad (5.19)$$

$$B = \tan \delta \cdot [\cos \phi / \tan \gamma - \sin \phi / (\sin \gamma \cdot \tan \beta)] \quad (5.20)$$

Table 5. 1. Azimuth angle according to wall orientation

Azimuth, $\gamma$	Tilt, $\beta$	Orientation
-----	$90^0$	Vertical wall
$0^0$	$90^0$	South-facing vertical
$-90^0$	$90^0$	East-facing wall
$+90^0$	$90^0$	West-facing wall

Therefore, monthly average absorbed radiation,  $\bar{S}$ , can be found by multiplying monthly average transmittance-absorptance product,  $(\overline{\tau\alpha})$ , and monthly average incident radiation on tilted surface ( $\overline{H_T}$ ).

$$\bar{S} = (\overline{\tau\alpha}) \cdot \overline{H_T} \quad (5.21)$$

$$\frac{(\overline{\tau\alpha})}{(\overline{\tau\alpha})_n} = \frac{\bar{S}}{\overline{H_T} \cdot (\overline{\tau\alpha})_n} \quad (5.22)$$

$$(\overline{\tau\alpha})_n = 1,01 \cdot \tau \cdot \alpha \quad (5.23)$$

$(\overline{\tau\alpha})$ , values are found with the help of diagrams which are given in *Solar Engineering of Thermal Processes* [7]. The diagrams can also be seen in Appendix, Table A3, Table A4 and Table A5.



### 5. 2. 1. Conduction Heat Gain or Loss ( $Q_C$ )

The heat loss by conduction and convection heat transfer through any surface is given by:

$$Q = U \cdot A \cdot [T_i - T_o] \quad (5. 23)$$

where;

$Q$ : Heat transfer through walls, roof, glass, floor, etc (W).

$A$ : Surface areas ( $m^2$ )

$U$ : Air-to-air heat transfer coefficient ( $W/m^2C$ )

$T_i$ : Indoor air temperature (C)

$T_o$ : Outdoor air temperature (C)

Heat transfer through basement external walls , ceiling , floors ,windows to the ground depends on:

- Difference between room air temperature and ground temperature/outdoor air temperature,
- Materials of walls, ceiling and floor of the basement,
- Conductivity of the surrounding earth.

### 5. 2. 2. Infiltration and Ventilation Heat Loss

The total heat loss due to indoor- outdoor air exchange,  $Q_v$  can be calculated by :

$$Q_v = Q_{inf} + Q_c \quad (5. 24)$$

$Q_{inf}$ : Infiltration heat loss (W)

$Q_c$ : Ventilation heat loss (W)

As mechanical ventilation has not been used, only natural air ventilation has been considered for total infiltration calculations which are given by;

$$Q_v = Q_{inf} = V \cdot \rho \cdot c_{pa} \cdot (T_i - T_o) \quad (5. 25)$$

$V$  : Volumetric air flow rate ( $\text{m}^3$ ),

$c_{pa}$  : Specific heat capacity of air at constant pressure, ( $\text{J} / \text{kg} \text{ } ^\circ\text{C}$  )

$\rho$  : Air density ( $\text{kg} / \text{m}^3$  )

### 5. 2. 3. Internal Heat Gain

The internal heat gain is divided into three main groups; occupants, lights and equipments which is given by;

$$Q_i = Q_p + Q_{light} + Q_e \quad (5. 26)$$

$Q_i$  : Internal heat gain

$Q_p$  : Heat gain from people

$Q_{light}$  : Heat gain from lightening

$Q_e$  : Heat gain from equipment

### 5. 2. 4. Passive Solar Gains

Total solar gain ( $Q_s$  ) equations for all orientations have been mentioned in the previous section.

Passive solar gains per square metre will be calculated parallel to glazing areas exposed to solar radiation for three cases – north-facing, south-facing and rotating - of the cafe.

## CHAPTER 6

### FINDINGS AND ANALYSIS

Steps that will be followed in calculations of the project are;

- Firstly, calculation of useful solar gains over heating season and calculation of increase in cooling load due to solar gains,
- Secondly, calculation of internal gains
- Thirdly, calculation of total heating demand over heating season and cooling demand over cooling season,
- Lastly, calculation of overall energy savings.

IYTE Cafe consists of two zones; living space and sunspace. As it is seen in Figure 6. 1, walls of IYTE Cafe will be named as A, B, C, D, E and F because walls will not face fixed directions. Their directions change according to the period. To make calculations of the project easier, for heat gain and heat loss calculations, three different cases of the building have been taken into consideration in order to evaluate the efficiency of the rotation system.

**1<sup>st</sup> Case:** In this case, it is assumed that the cafe does not rotate and its sunspace is facing the south.

**2<sup>nd</sup> Case:** In this case, it is assumed that the cafe does not rotate and its sunspace is facing the north.

**3<sup>rd</sup> Case:** This case is the rotating version of the project. The orientation of the cafe changes with the help of a rotation system. Depending on the climatic and local features of the building site, it is determined that the cafe should rotate two times a year for thermal benefit.

These two positions are:

- **Winter Position:** In winter position, sunspace of the cafe faces the south from May 1<sup>st</sup> till September 30<sup>th</sup>. This period is called winter period in our project. In winter period, the goal is to acquire solar energy as much as possible so the sunspace, major collector area of the building, is subjected to direct solar radiation.

- **Summer Position:** In summer position, the cafe is rotated 180° and the sunspace faces the north from October 1<sup>st</sup> till April 30<sup>th</sup>. This period is called summer period in our project. In summer period, the aim is to protect the building from direct sunlight as much as possible so the sunspace is rotated to the north.

In this chapter, calculations will be done under two main headings;

1. Calculation of monthly useful solar energy,
2. Monthly heat gain and heat loss calculations.

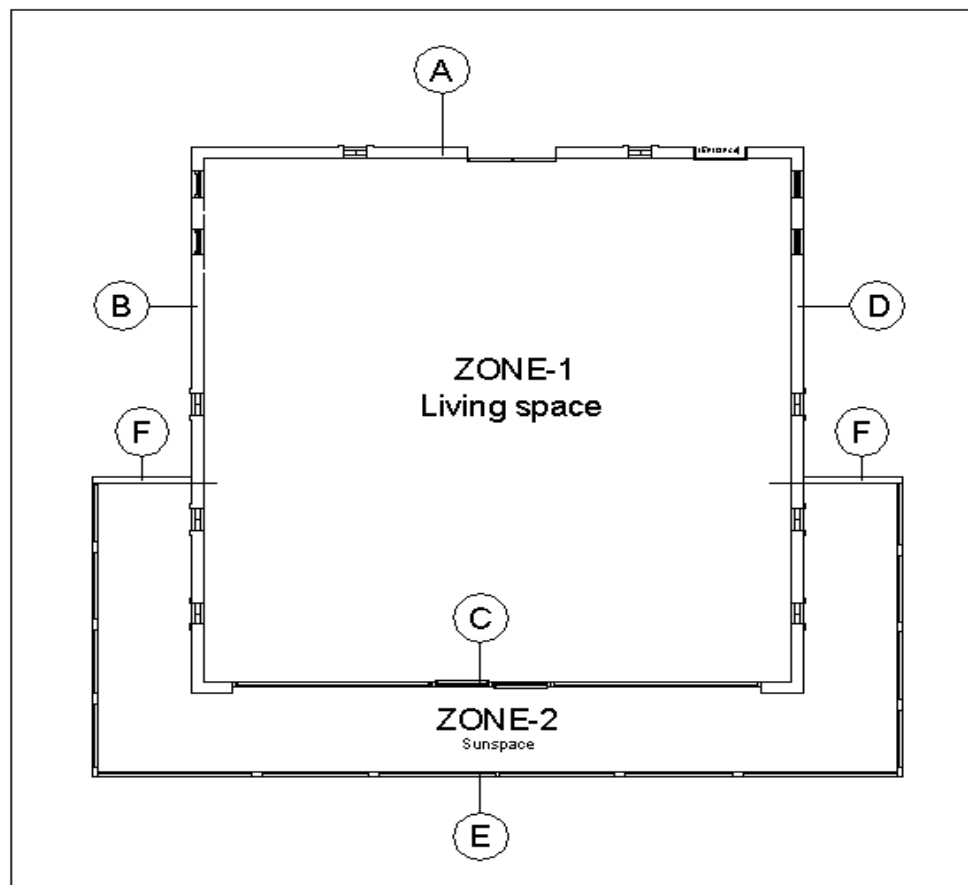
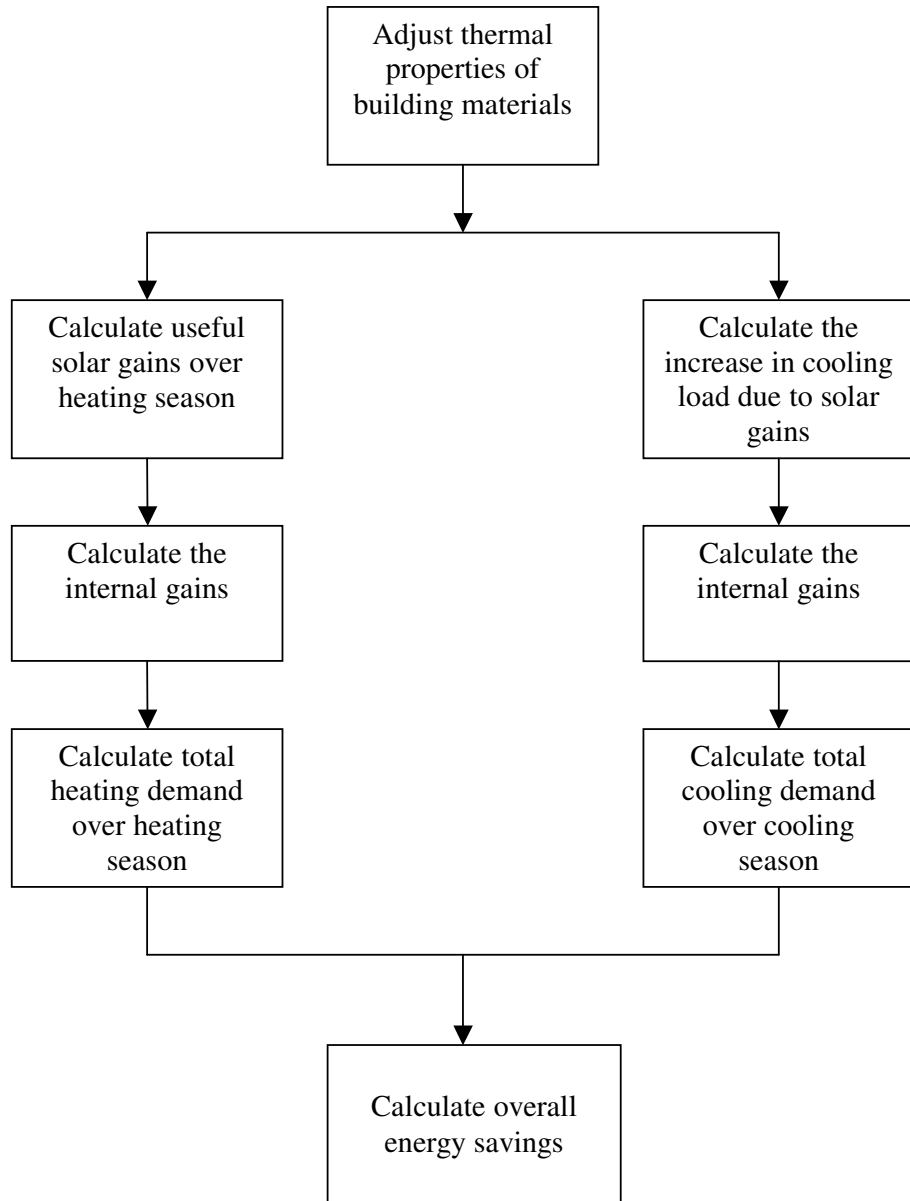

Figure 6. 1. Simplified representation of IYTE Cafe

Table 6. 1. Calculation methodology





## 6. 1. Calculation of Monthly Useful Solar Energy

The calculation steps are:

- Determining solar radiation,  $H_o$ ,  $H_b$ ,  $H_d$  and  $\omega_s$
- The Monthly Average Clearness Index  $\bar{K}_T$
- Determining  $\mathbf{H_T}$  ,  $S$

### 6. 1.1. Calculation of Sunset Hour Angles

Calculation of the sunset hour angle ( $\omega_s$ ) is given by expression:

$$\cos \omega_s = -\tan \phi \cdot \tan \delta \quad (6. 1)$$

In Table 6.2 , the sunset or sunrise hour angle is given for horizontal surface and  $\beta = 90$

where  $\phi$  = latitude of the location (38,24° for İzmir-Gülbahçe)

$\delta$  = solar declination

$\delta$  changes with mean day of the month and it is given by expression:

$$\delta = 23,45 \sin(360 \cdot (284 + n) / 365) \quad (6. 2)$$

where n = mean day of the month

Table 6. 2. Monthly values of  $n$  ,  $\delta$  and  $\omega_s$

	Jan.	Feb	Mar.	Apr.	May	Jun.	Jul.	Aug.	Sep.	Oct.	Nov.	Dec.
$n$	17	47	75	105	135	162	198	228	258	288	318	344
$\delta$	-20,9	-13	-2,4	9,4	18,8	23,1	21,1	13,5	2,2	-9,6	-18,9	-23
$\omega_s$	72,49	79,52	88,11	97,50	105,56	109,64	107,70	100,90	91,74	83,34	74,35	70,46

### 6. 1. 2. Solar Radiation :

Table 6. 2 demonstrates  $\bar{H}$  and  $\bar{H}_o$  values for İzmir (Latitude: 38,2°).

These values are taken from *İsısan: Güneş Enerjisi Tesisatı* .

Table 6.3. Monthly Average  $\bar{H}$  and  $\bar{H}_o$  values for İzmir

	Jan.	Feb	Mar.	Apr.	May	Jun.	Jul.	Aug.	Sep.	Oct.	Nov.	Dec.
$\bar{H}$	6,6	9,4	13,2	17,6	22,4	24	24,6	23	18,4	12,6	8,1	6,1
$\bar{H}_o$	16,1	21,3	27,9	34,7	39,4	41,3	40,3	36,5	30,3	23,2	17,3	14,7
$\bar{H}_d$	3,22	4,25	6,01	7,43	8,20	8,52	8,09	7,17	6,11	4,42	3,43	2,94
$\bar{H}_b$	3,38	5,15	7,19	10,17	14,20	15,48	16,51	15,83	12,29	8,18	4,67	3,16

$\bar{H}$  : Monthly average daily radiation on a horizontal surface

$\bar{H}_o$  : Monthly average extraterrestrial radiation for the location

$\bar{H}_d$  : Monthly average diffuse radiation for the location

$\bar{H}_b$  : Monthly average beam radiation for the location

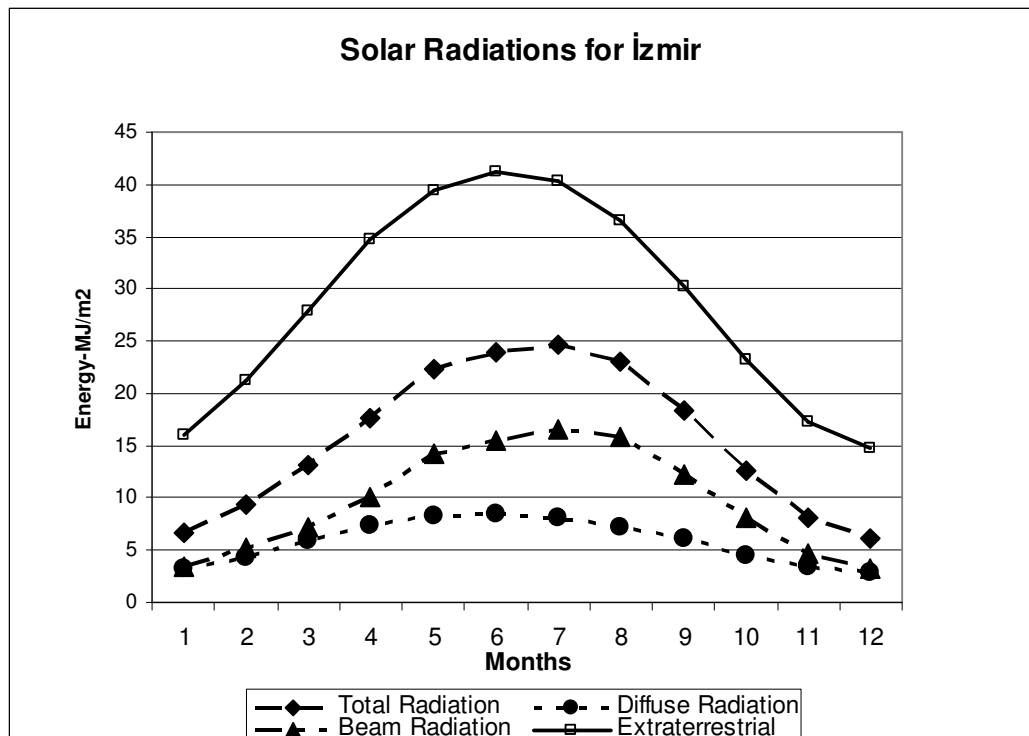

Figure 6. 2. Solar radiation values for İzmir

### 6. 1. 3. Monthly Average Clearness Index

Monthly average clearness index calculations are given below.

January	: $\bar{K}_T = \bar{H} / \bar{H}_0 = 6,6/16,1 = 0,41$
February	: $\bar{K}_T = \bar{H} / \bar{H}_0 = 9,4/21,3 = 0,44$
March	: $\bar{K}_T = \bar{H} / \bar{H}_0 = 13,2/27,9 = 0,473$
April	: $\bar{K}_T = \bar{H} / \bar{H}_0 = 17,6/34,7 = 0,507$
May	: $\bar{K}_T = \bar{H} / \bar{H}_0 = 22,4/39,4 = 0,569$
June	: $\bar{K}_T = \bar{H} / \bar{H}_0 = 24/41,3 = 0,581$
July	: $\bar{K}_T = \bar{H} / \bar{H}_0 = 24,6/40,3 = 0,61$
August	: $\bar{K}_T = \bar{H} / \bar{H}_0 = 23/36,5 = 0,63$
September	: $\bar{K}_T = \bar{H} / \bar{H}_0 = 18,4/30,3 = 0,607$
October	: $\bar{K}_T = \bar{H} / \bar{H}_0 = 12,6/23,2 = 0,543$
November	: $\bar{K}_T = \bar{H} / \bar{H}_0 = 8,1/17,3 = 0,468$
December	: $\bar{K}_T = \bar{H} / \bar{H}_0 = 6,1/14,7 = 0,415$

On the basis of monthly average clearness index prediction of monthly average daily horizontal diffuse radiation from monthly average daily horizontal radiation calculations are given below.

From equation 5. 10a and 5. 10b;

$$\text{January} \quad : \quad \frac{\bar{H}_d}{H} = 1,391 - 3,560 \cdot 0,41 + 4,189 \cdot 0,41^2 - 2,137 \cdot 0,41^3 = 0,488$$

$$\text{February} \quad : \quad \frac{\bar{H}_d}{H} = 1,391 - 3,560 \cdot 0,44 + 4,189 \cdot 0,44^2 - 2,137 \cdot 0,44^3 = 0,452$$

$$\text{March} \quad : \quad \frac{\bar{H}_d}{H} = 1,311 - 3,022 \cdot 0,47 + 3,427 \cdot 0,47^2 - 1,821 \cdot 0,47^3 = 0,418$$

$$\begin{aligned}
\text{April} & : \frac{\overline{H}_d}{\overline{H}} = 1,311 - 3,022 \cdot 0,51 + 3,427 \cdot 0,51^2 - 1,821 \cdot 0,51^3 = 0,384 \\
\text{May} & : \frac{\overline{H}_d}{\overline{H}} = 1,311 - 3,022 \cdot 0,57 + 3,427 \cdot 0,57^2 - 1,821 \cdot 0,57^3 = 0,328 \\
\text{June} & : \frac{\overline{H}_d}{\overline{H}} = 1,311 - 3,022 \cdot 0,58 + 3,427 \cdot 0,58^2 - 1,821 \cdot 0,58^3 = 0,317 \\
\text{July} & : \frac{\overline{H}_d}{\overline{H}} = 1,311 - 3,022 \cdot 0,61 + 3,427 \cdot 0,61^2 - 1,821 \cdot 0,61^3 = 0,293 \\
\text{August} & : \frac{\overline{H}_d}{\overline{H}} = 1,311 - 3,022 \cdot 0,63 + 3,427 \cdot 0,63^2 - 1,821 \cdot 0,63^3 = 0,276 \\
\text{September} & : \frac{\overline{H}_d}{\overline{H}} = 1,311 - 3,022 \cdot 0,61 + 3,427 \cdot 0,61^2 - 1,821 \cdot 0,61^3 = 0,295 \\
\text{October} & : \frac{\overline{H}_d}{\overline{H}} = 1,391 - 3,560 \cdot 0,54 + 4,189 \cdot 0,54^2 - 2,137 \cdot 0,54^3 = 0,351 \\
\text{November} & : \frac{\overline{H}_d}{\overline{H}} = 1,391 - 3,560 \cdot 0,47 + 4,189 \cdot 0,47^2 - 2,137 \cdot 0,47^3 = 0,423 \\
\text{December} & : \frac{\overline{H}_d}{\overline{H}} = 1,391 - 3,560 \cdot 0,41 + 4,189 \cdot 0,41^2 - 2,137 \cdot 0,41^3 = 0,482
\end{aligned}$$

Table 6. 4. Monthly average  $\overline{K}_T$  and  $\overline{H}_d / \overline{H}$

	Jan.	Feb.	Mar.	Apr.	May	Jun.	Jul.	Aug.	Sep.	Oct.	Nov.	Dec.
$\overline{K}_T$	0,41	0,44	0,473	0,507	0,569	0,58	0,610	0,63	0,607	0,543	0,468	0,415
$\overline{H}_d / \overline{H}$	0,454	0,424	0,394	0,365	0,317	0,308	0,286	0,271	0,288	0,336	0,398	0,449

#### 6. 1. 4. Monthly Average Beam Radiation Factor

**For south facing vertical;**  $\gamma = 0$  and  $\beta = 0$ ,

From equation 5. 13;

January:

$$\bar{R}_b = \frac{\cos(38,24-90) \cdot \cos(-20,9) \cdot \sin(72,49) + (\pi/180) \cdot (72,49) \cdot \sin(38,24-90) \cdot \sin(-20,9)}{\cos(38,24) \cdot \cos(-20,9) \cdot \sin(72,49) + (\pi/180) \cdot (72,49) \cdot \sin(38,24) \cdot \sin(-20,9)} = 2,15$$

February:

$$\bar{R}_b = \frac{\cos(38,24-90) \cdot \cos(-13) \cdot \sin(79,52) + (\pi/180) \cdot (79,52) \cdot \sin(38,24-90) \cdot \sin(-13)}{\cos(38,24) \cdot \cos(-13) \cdot \sin(79,52) + (\pi/180) \cdot (79,52) \cdot \sin(38,24) \cdot \sin(-13)} = 1,50$$

March:

$$\bar{R}_b = \frac{\cos(38,24-90) \cdot \cos(-2,4) \cdot \sin(88,11) + (\pi/180) \cdot (88,11) \cdot \sin(38,24-90) \cdot \sin(-2,4)}{\cos(38,24) \cdot \cos(-2,4) \cdot \sin(88,11) + (\pi/180) \cdot (88,11) \cdot \sin(38,46) \cdot \sin(-2,4)} = 0,90$$

April:

$$\bar{R}_b = \frac{\cos(38,24-90) \cdot \cos(9,4) \cdot \sin(77,87) + (\pi/180) \cdot (77,87) \cdot \sin(38,24-90) \cdot \sin(9,4)}{\cos(38,24) \cdot \cos(9,4) \cdot \sin(97,50) + (\pi/180) \cdot (97,50) \cdot \sin(38,24) \cdot \sin(9,4)} = 0,45$$

May:

$$\bar{R}_b = \frac{\cos(38,24-90) \cdot \cos(18,8) \cdot \sin(64,40) + (\pi/180) \cdot (64,40) \cdot \sin(38,24-90) \cdot \sin(18,8)}{\cos(38,24) \cdot \cos(18,8) \cdot \sin(105,56) + (\pi/180) \cdot (105,56) \cdot \sin(38,24) \cdot \sin(18,8)} = 0,23$$

June:

$$\bar{R}_b = \frac{\cos(38,24-90) \cdot \cos(23,1) \cdot \sin(57,23) + (\pi/180) \cdot (57,23) \cdot \sin(38,24-90) \cdot \sin(23,1)}{\cos(38,24) \cdot \cos(23,1) \cdot \sin(109,64) + (\pi/180) \cdot (109,64) \cdot \sin(38,24) \cdot \sin(23,1)} = 0,15$$

July:

$$\bar{R}_b = \frac{\cos(38,24-90) \cdot \cos(21,1) \cdot \sin(60,68) + (\pi/180) \cdot (60,68) \cdot \sin(38,24-90) \cdot \sin(21,1)}{\cos(38,24) \cdot \cos(21,1) \cdot \sin(107,70) + (\pi/180) \cdot (107,70) \cdot \sin(38,24) \cdot \sin(21,1)} = 0,19$$

August:

$$\bar{R}_b = \frac{\cos(38,24-90) \cdot \cos(13,5) \cdot \sin(72,26) + (\pi/180) \cdot (72,26) \cdot \sin(38,24-90) \cdot \sin(13,5)}{\cos(38,24) \cdot \cos(13,5) \cdot \sin(100,90) + (\pi/180) \cdot (100,90) \cdot \sin(38,24) \cdot \sin(13,5)} = 0,34$$

September:

$$\bar{R}_b = \frac{\cos(38,24-90) \cdot \cos(2,2) \cdot \sin(87,2) + (\pi/180) \cdot (87,2) \cdot \sin(38,24-90) \cdot \sin(2,2)}{\cos(38,24) \cdot \cos(2,2) \cdot \sin(91,74) + (\pi/180) \cdot (91,74) \cdot \sin(38,24) \cdot \sin(2,2)} = 0,70$$

October:

$$\bar{R}_b = \frac{\cos(38,24-90) \cdot \cos(-9,6) \cdot \sin(83,34) + (\pi/180) \cdot (83,34) \cdot \sin(38,24-90) \cdot \sin(-9,6)}{\cos(38,24) \cdot \cos(-9,6) \cdot \sin(83,34) + (\pi/180) \cdot (83,34) \cdot \sin(38,24) \cdot \sin(-9,6)} = 1,29$$

November:

$$\bar{R}_b = \frac{\cos(38,24-90) \cdot \cos(-18,9) \cdot \sin(74,35) + (\pi/180) \cdot (74,35) \cdot \sin(38,24-90) \cdot \sin(-18,9)}{\cos(38,24) \cdot \cos(-18,9) \cdot \sin(74,35) + (\pi/180) \cdot (74,35) \cdot \sin(38,24) \cdot \sin(-18,9)} = 1,96$$

December:

$$\overline{R}_b = \frac{\cos(38,24-90) \cdot \cos(-23) \cdot \sin(70,46) + (\pi/180) \cdot (70,46) \cdot \sin(38,24-90) \cdot \sin(-23)}{\cos(38,24) \cdot \cos(-23) \cdot \sin(70,46) + (\pi/180) \cdot (70,46) \cdot \sin(38,24) \cdot \sin(-23)} = 2,38$$

**For east and west sides;  $\gamma = \mu 90$**

Equation 5. 14 has been used. The results for  $\overline{R}_b$  are shown on Table 6. 5.

Table 6. 5. Monthly average beam radiation factor for south, north, east and west sides of IYTE Cafe

Orientation	Jan.	Feb.	Mar.	Apr.	May	Jun.	Jul.	Aug.	Sep.	Oct.	Nov.	Dec.
South, $\overline{R}_b$	2,15	1,50	0,90	0,45	0,23	0,15	0,19	0,34	0,70	1,29	1,96	2,38
East/West $\overline{R}_b$	0,78	0,72	0,65	0,60	0,55	0,54	0,55	0,58	0,63	0,70	0,76	0,80

### 6. 1. 5. Monthly Solar Radiation on a Tilted Surface

**For south side;**

Assumption,  $\rho = 0,2$  (the ground reflectance is assumed for all months. )

From equation 5. 12;

January:

$$\overline{H}_T = 6,6 \cdot (1 - 0,454) \cdot 2,172 + 2,996 \cdot \left( \frac{1 + \cos 90}{2} \right) + 6,6 \cdot 0,2 \cdot \left( \frac{1 - \cos 90}{2} \right) = 9,987 \text{ MJ/m}^2$$

February:

$$\overline{H}_T = 9,4 \cdot (1 - 0,424) \cdot 1,51 + 3,985 \cdot \left( \frac{1 + \cos 90}{2} \right) + 9,4 \cdot 0,2 \cdot \left( \frac{1 - \cos 90}{2} \right) = 11,109 \text{ MJ/m}^2$$

March:

$$\overline{H}_T = 13,2 \cdot (1 - 0,394) \cdot 0,905 + 5,200 \cdot \left( \frac{1 + \cos 90}{2} \right) + 13,2 \cdot 0,2 \cdot \left( \frac{1 - \cos 90}{2} \right) = 11,16 \text{ MJ/m}^2$$

April:

$$\overline{H}_T = 17,6 \cdot (1 - 0,365) \cdot 0,454 + 6,424 \cdot \left( \frac{1 + \cos 90}{2} \right) + 17,6 \cdot 0,2 \cdot \left( \frac{1 - \cos 90}{2} \right) = 10,045 \text{ MJ/m}^2$$

May:

$$\overline{H_T} = 22,4 \cdot (1 - 0,317) \cdot 0,228 + 7,100 \cdot \left(\frac{1 + \cos 90}{2}\right) + 22,4 \cdot 0,2 \cdot \left(\frac{1 - \cos 90}{2}\right) = 9,278 \text{ MJ/m}^2$$

June:

$$\overline{H_T} = 24 \cdot (1 - 0,308) \cdot 0,152 + 7,392 \cdot \left(\frac{1 + \cos 90}{2}\right) + 24 \cdot 0,2 \cdot \left(\frac{1 - \cos 90}{2}\right) = 8,620 \text{ MJ/m}^2$$

July:

$$\overline{H_T} = 24,6 \cdot (1 - 0,286) \cdot 0,185 + 7,035 \cdot \left(\frac{1 + \cos 90}{2}\right) + 24,6 \cdot 0,2 \cdot \left(\frac{1 - \cos 90}{2}\right) = 9,227 \text{ MJ/m}^2$$

August:

$$\overline{H_T} = 23 \cdot (1 - 0,271) \cdot 0,344 + 6,233 \cdot \left(\frac{1 + \cos 90}{2}\right) + 23 \cdot 0,2 \cdot \left(\frac{1 - \cos 90}{2}\right) = 11,184 \text{ MJ/m}^2$$

September:

$$\overline{H_T} = 18,4 \cdot (1 - 0,288) \cdot 0,70 + 5,300 \cdot \left(\frac{1 + \cos 90}{2}\right) + 18,4 \cdot 0,2 \cdot \left(\frac{1 - \cos 90}{2}\right) = 13,658 \text{ MJ/m}^2$$

October:

$$\overline{H_T} = 12,6 \cdot (1 - 0,336) \cdot 1,29 + 4,234 \cdot \left(\frac{1 + \cos 90}{2}\right) + 12,6 \cdot 0,2 \cdot \left(\frac{1 - \cos 90}{2}\right) = 14,169 \text{ MJ/m}^2$$

November:

$$\overline{H_T} = 8,1 \cdot (1 - 0,398) \cdot 1,98 + 3,224 \cdot \left(\frac{1 + \cos 90}{2}\right) + 8,1 \cdot 0,2 \cdot \left(\frac{1 - \cos 90}{2}\right) = 12,076 \text{ MJ/m}^2$$

December:

$$\overline{H_T} = 6,1 \cdot (1 - 0,449) \cdot 2,4 + 2,739 \cdot \left(\frac{1 + \cos 90}{2}\right) + 6,1 \cdot 0,2 \cdot \left(\frac{1 - \cos 90}{2}\right) = 10,046 \text{ MJ/m}^2$$

Table 6. 6. Monthly average solar radiation on south, north, east and west sides of IYTE Cafe

Orientation	Jan.	Feb.	Mar.	Apr.	May	Jun.	Jul.	Aug.	Sep.	Oct.	Nov.	Dec.
South, $\overline{H_T}$	9,53	10,79	10,80	10,05	9,60	8,98	9,643	11,27	13,50	14,02	11,68	9,60
East/West, $\overline{H_T}$	4,91	6,77	9,00	11,58	14,15	15,02	15,59	15,07	12,64	9,20	6,08	4,61
North, $\overline{H_T}$	2,27	3,07	4,33	5,48	6,34	6,66	6,50	5,89	4,90	3,47	2,52	2,10

### 6. 1. 6. Monthly Average Absorbed Radiation

Monthly absorbed radiation calculations have been done for all sides of the building by using equation 5. 21. The results are shown in the following table.

$$\bar{S} = (\overline{\tau\alpha}) \cdot \bar{H}_\tau$$

The monthly average transmittance-absorption product,  $(\overline{\tau\alpha})$ ,

Table 6. 7. Monthly average transmittance-absorptance product for four directions

Orientation	Jan.	Feb.	Mar.	Apr.	May	Jun.	Jul.	Aug.	Sep.	Oct.	Nov.	Dec.
North, South $(\overline{\tau\alpha})$	0,68	0,65	0,60	0,55	0,50	0,44	0,42	0,48	0,58	0,64	0,68	0,70
East, West, $(\overline{\tau\alpha})$	0,55	0,56	0,56	0,58	0,60	0,60	0,60	0,60	0,60	0,58	0,55	0,55

Table 6. 8 . Monthly average absorbed radiation for south, north, east and west sides of IYTE Cafe

Orientation	Jan.	Feb.	Mar.	Apr.	May	Jun.	Jul.	Aug.	Sep.	Oct.	Nov.	Dec.
South, $\bar{S}$	6,48	7,01	6,48	5,53	4,80	3,95	4,05	5,41	7,83	8,97	7,94	6,72
East/West, $\bar{S}$	2,70	3,79	5,04	6,72	8,49	9,01	9,35	9,04	7,58	5,34	3,34	2,54
North, $\bar{S}$	1,54	2,00	2,60	3,01	3,17	2,93	2,73	2,83	2,84	2,22	1,71	1,47

### 6. 2. Heating and Cooling Load Calculations

Heat gain and heat loss calculation steps are;

- Accepted design parameters
- Calculating overall heat transfer coefficient
- Calculating heat loss of IYTE Cafe for three cases of the building
- Calculating heat gain of IYTE Cafe for three cases of the building



## 6. 2. 1. Design Parameters

Climatic and local values of location of the building and indoor design parameters influence heat gain and heat loss calculations. In principle, the heating and cooling loads are calculated to maintain the indoor design conditions when the outdoor weather data do not exceed the design values. In this project, outdoor design temperature has been determined by using monthly average outdoor temperature recorded by Meteorology Department in İzmir since 1938 .

On the basis of the values in Table 6.9 ;

- Monthly average **maximum temperature values** in summer period have been used for cooling load calculations,
- Monthly average **minimum temperature values** in winter period have been used for heating load calculations.

For most of the comfort air-conditioning systems used in residential, commercial and public buildings, the recommended indoor temperature and relative humidity are as follows (ASHREA 2001) :

- Summer: 23,5-25,5 °C dry bulb temperature, 40-60% relative humidity,
- Winter: 21-23,5 °C dry bulb temperature, 20-30% relative humidity.

On the basis of these values as well as energy saving strategies, summer period design temperature has been accepted to be 25,5 °C and winter period design temperature has been taken 21 °C (Table 6. 9).

Table 6. 9. Accepted temperature design values (shown with grey colour)

	Jan.	Feb.	Mar.	Apr.	May	Jun.	Jul.	Aug.	Sep.	Oct.	Nov.	Dec.
Average, $T_o$	8,7	9,3	11,3	15,6	20,6	25,3	27,7	27,3	23,4	18,7	14,0	10,4
Maximum OutTemp, $T_o$	12,3	13,4	16	20,7	25,9	30,6	33	32,7	29	23,9	18,4	13,9
Minimum OutTemp, $T_o$	5,7	5,9	7,3	10,9	15,2	19,5	22,1	21,9	18,4	14,4	10,6	7,5
InnerTemp., $T_i$	21	21	21	21	25,5	25,5	25,5	25,5	25,5	21	21	21

## 6. 2. 2. Thermal Loss Coefficients for the Building

Building loss coefficients of selected materials for our project have been mentioned in the previous Chapter 4 and Table 4.1. Details about the materials and where they are used can be seen in related figures. Features of these materials are taken from ASHRAE, TS 825, catalogues of some firms and the book *Building Heat Insulation Standards*.

According to the building materials total heat loss through building surfaces will be done but because of the rotation function, directions of building elevations change. Therefore, in order to make calculations easier and differentiate each elevation in each case of the building, elevations have been examined separately (Figure 6.3 and Table 6.11).

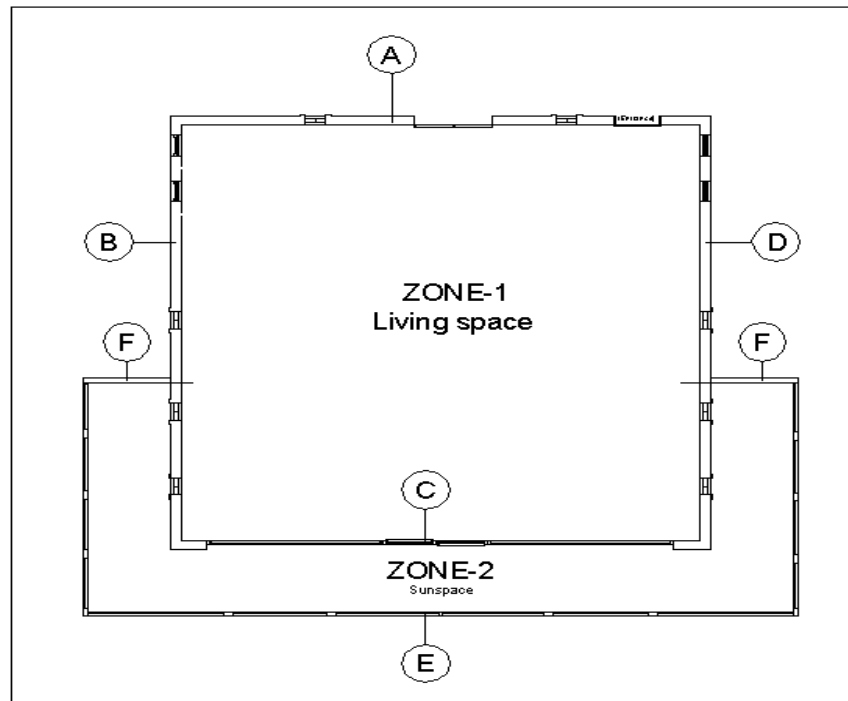

Figure 6.3. Elevations of the building

Table 6. 10. Total specific heat loss of the building

TOTAL SPECIFIC HEAT LOSS

A - ELEVATION SPECIFIC HEAT LOSS

Construction Components	U-Heat Transfer Coeff. (W/m <sup>2</sup> K)	Area (m <sup>2</sup> )	U x A (W/K)
Window	3,51	0,00	0,00
Glass brick	2,80	1,44	4,03
Entrance double glass door	4,18	3,30	13,79
Aluminum kitchen entrance	5,60	1,98	11,09
Net outside wall	0,54	20,28	10,89
Total Heat Loss:			39,80

B - ELEVATION SPECIFIC HEAT LOSS

Construction Components	U-Heat Transfer Coeff. (W/m <sup>2</sup> K)	Area (m <sup>2</sup> )	U x A (W/K)
Toilet hung window	3,51	0,40	1,40
Glass brick	2,80	0,72	2,02
Net outside wall	0,54	16,43	8,87
Total Heat Loss:			12,29

C - ELEVATION SPECIFIC HEAT LOSS

Yapı Elemanı	U-Heat Transfer Coeff. (W/m <sup>2</sup> K)	Area (m <sup>2</sup> )	U x A (W/K)
Window	3,51	21,00	73,71
Glass brick	2,80	2,88	8,06
Sunspace double glass door	4,18	3,30	13,79
Net outside wall	0,54	18,72	10,05
Total Heat Loss:			105,62

D - ELEVATION SPECIFIC HEAT LOSS

Construction Components	U-Heat Transfer Coeff. (W/m <sup>2</sup> K)	Area (m <sup>2</sup> )	U x A (W/K)
Kitchen window	3,51	0,40	1,40
Glass brick	2,80	0,72	2,02
Net outside wall	0,54	16,16	8,68
Total Heat Loss:			12,10

E - ELEVATION SPECIFIC HEAT LOSS

Construction Components	U-Isi iletkenlik Katsayısı (W/m <sup>2</sup> K)	Area (m <sup>2</sup> )	U x A (W/K)
Sunspace Glass	3,51	53,68	188,42
Total Heat Loss:			188,42

F - ELEVATION SPECIFIC HEAT LOSS

Construction Components	U-Heat Transfer Coeff. (W/m <sup>2</sup> K)	Area (m <sup>2</sup> )	U x A (W/K)
Outside Wall	0,54	7,84	4,23
Total Heat Loss:			4,23

SPECIFIC HEAT LOSS FOR OTHER AREAS

Construction Components	U-Heat Transfer Coeff. (W/m <sup>2</sup> K)	Area (m <sup>2</sup> )	U x A (W/K)
Zone-1 Ceiling	0,31	100,00	30,90
Zone-2 Sunspace Roof Cover	0,32	41,00	13,12
Zone-1 Living space Floor	0,56	100,00	56,00
Zone-2 Sun space Floor	0,56	34,00	19,04
Cloristory-double window low-e	2,67	1,40	3,74
Zone1- Operable Summer Vent Sunspace- Operable Summer	5,88	0,70	4,12
Double hung window Low-e	2,67	1,00	2,67

### 6. 2. 3. Heat Loss Calculations

Total Heat Gain;

$$\sum Q_{zone1} = Q_{zone2} + Q_c + Q_v + Q_i + Q_s \quad (6.3)$$

Total Heat Loss;

$$\sum Q_{zone1} = Q_c + Q_v - (Q_s + Q_i + Q_{zone2}) \quad (6.4)$$

#### 6. 2. 3. 1. Heat Transmission Loss

$$Q_c = U \cdot A \cdot (T_i - T_o) \quad (6.5)$$

**Zone -1 :**

A - Elevation : U.A = 39, 80 W/K

B - Elevation : U.A = 12, 29 W/K

C – Elevation : U.A = 105, 62 W/K

D – Elevation : U.A = 12, 10 W/K

Ceiling : U.A = 30, 90 W/K

Floor : U.A = 56, 00 W/K

Clerestory : U.A = 3, 74 W/K

Summer Vent : U.A = 4, 12 W/K

Total U. A = 264, 57 W/ K

For two cases, the building transmission loss and gain has been examined; in winter period, in Case-1, (sunspace is south-facing) sunspace temperature is higher than the living space temperature so there is not any heat loss through C elevation.

In summer period, in Case-1, because of solar radiation sunspace is so overheated that temperature in the sunspace is higher than outdoor temperature. By opening sunroofs, sunspace temperature has been drawn closer to outdoor temperature. For that reason,  $T_s = T_o$  has been used in this calculations.

Table 6.11 Monthly heat transmission loss of living space for the south facing

1. Case : Sunspace Facing the South

MONTHLY HEAT TRANSMISSION LOSS OF ZONE-1														
Month	Heat lost (Except C wall)					C-wall Heat Lost					Total Heat Lost			
	U x A	Tin	Tout	$\Delta T$	Heat Lost	U x A	Tin	Ts	$\Delta T$	Heat Lost	W/h	MJ/day		
	W/C	C	C	C	W	W/C	C	C	C	W				
January		21	5,7	15,3	2431,94		21	-	0	0,00	2431,94	210,12		
February		21	5,9	15,1	2400,15		21	-	0	0,00	2400,15	207,37		
March		21	7,3	13,7	2177,62		21	-	0	0,00	2177,62	188,15		
April		21	10,9	10,1	1605,40		21	-	0	0,00	1605,40	138,71		
May											0,00	0,00		
June											0,00	0,00		
July	158,95		SUMMER PERIOD			105,62		SUMMER PERIOD			0,00	0,00		
August											0,00	0,00		
September											0,00	0,00		
October		21	14,4	6,6	1049,07		21	-	0	0,00	1049,07	90,64		
November		21	10,4	10,6	1684,87		21	-	0	0,00	1684,87	145,57		
December		21	7,5	13,5	2145,83		21	-	0	0,00	2145,83	185,40		
TOTAL :					13494,86						13494,86	1165,96		

Table 6.12 Monthly heat transmission loss of living space for the north facing

2. Case : Sunspace Facing the North

<b>MONTHLY HEAT TRANSMISSION LOSS OF ZONE-1</b>															
Month	Heat lost (Except C wall)						C-wall Heat Lost						Total Heat Lost		
	U x A	Tin	Tout	$\Delta T$	Heat Lost	U x A	Tin	Ts	$\Delta T$	Heat Lost	W/h	MJ/day			
	W/C	C	C	C	W	W/C	C	C	C	W					
January		21	5,7	15,3	2431,94		21	10,6	10,4	1098,45	3530,38	305,03			
February		21	5,9	15,1	2400,15		21	10,7	10,3	1087,89	3488,03	301,37			
March		21	7,3	13,7	2177,62		21	11,7	9,3	982,27	3159,88	273,01			
April		21	10,9	10,1	1605,40		21	14,1	6,9	728,78	2334,17	201,67			
May											0,00	0,00			
June											0,00	0,00			
July	158,95					105,62					0,00	0,00			
August											0,00	0,00			
September											0,00	0,00			
October		21	14,4	6,6	1049,07		21	16,5	4,5	475,29	1524,36	131,70			
November		21	10,4	10,6	1684,87		21	13,9	7,1	749,90	2434,77	210,36			
December		21	7,5	13,5	2145,83		21	11,8	9,2	971,70	3117,53	269,35			
<b>TOTAL :</b>					<b>13494,86</b>					<b>6094,27</b>	<b>19589,13</b>	<b>1692,50</b>			

Table 6.13 Monthly heat transmission gain of living space for the south facing

1. Case : Sunspace Facing the South

MONTHLY HEAT TRANSMISSION GAIN OF ZONE-1													
Month	Heat Gain (Except C wall)				C-wall Heat Gain				Total Heat Gain				
	U x A W/C	Tin C	Tout C	$\Delta T$ C	Heat Gain W	U x A W/C	Tin C	Ts=To C	$\Delta T$ C	Heat Gain W	W	MJ/day	
January											0,00	0,00	
February											0,00	0,00	
March											0,00	0,00	
April											0,00	0,00	
May		25,5	25,9	0,4	63,58		25,5	25,9	0,4	42,25	105,83	9,14	
June		25,5	30,6	5,1	810,65		25,5	30,6	5,1	538,66	1349,31	116,58	
July	158,95	25,5	33	7,5	1192,13	105,62	25,5	33	7,5	792,15	1984,28	171,44	
August		25,5	32,7	7,2	1144,44		25,5	32,7	7,2	760,46	1904,90	164,58	
September		25,5	29	3,5	556,33		25,5	29	3,5	369,67	926,00	80,01	
October											0,00	0,00	
November											0,00	0,00	
December											0,00	0,00	
TOTAL :					3767,12					2503,19	6270,31	541,75	

Table 6.14 Monthly heat transmission gain of living space for the north facing

2. Case : Sunspace Facing the North

MONTHLY HEAT TRANSMISSION GAIN OF ZONE-1													
Month	Heat Gain (Except C wall )					C-wall Heat Gain					Total Heat Gain		
	U x A	Tin	Tout	ΔT	Heat Gain	U x A	Tin	Ts	ΔT	Heat Gain	W	MJ/day	
	W/C	C	C	C	W	W/C	C	C	C	W			
January											0,00	0,00	
February											0,00	0,00	
March											0,00	0,00	
April											0,00	0,00	
May		25,5	25,9	0,4	63,58		25,5	25,8	0,3	31,69	95,27	8,23	
June		25,5	30,6	5,1	810,65		25,5	29	3,5	369,67	1180,32	101,98	
July	158,95	25,5	33	7,5	1192,13	105,62	25,5	30,6	5,1	538,66	1730,79	149,54	
August		25,5	32,7	7,2	1144,44		25,5	30,4	4,9	517,54	1661,98	143,59	
September		25,5	29	3,5	556,33		25,5	27,9	2,4	253,49	809,81	69,97	
October											0,00	0,00	
November											0,00	0,00	
December											0,00	0,00	
TOTAL :					3767,12					1711,04	5478,16	473,31	



### 6. 2. 3. 2. The Average Net Gain in Sunspace ( $Q_{zone2}$ )

There is not any internal heat gain in the sunspace ( $Q_i = 0$ ) so net heat gain of the sunspace is given by;

$$Q_{zone2} = Q_s - Q_c - Q_v \quad (6. 6)$$

#### Zone-2:

E-Elevation : U.A = 188,42 W/C

F-Elevation : U.A = 4,23 W/C

Sunspace roof : U.A = 13,12 W/C

Floor : U.A = 19,04 W/C

Sunspace double hung: U.A = 2,67 W/C

Total U.A : 227,48 W/C

#### Calculation of Sunspace Temperature without solar gain

$$T_s = \frac{\sum(U_i \cdot A_i \cdot T_i) + (U_o \cdot A_o \cdot T_o)}{\sum(\sum U_i \cdot A_i) + (\sum U_o \cdot A_o)} \quad (6. 7)$$

$U_i$  : Heat transfer coefficient of heat gained surfaces

$U_o$  : Heat transfer coefficient of heat lost surfaces

$A_i$  : Area of heat gained surfaces ( C-Elevation)

$A_o$  : Area of heat lost surfaces ( E and F – Elevation, floor, ceiling and sunroof )

$T_i$  : Indoor temperature (It changes in summer period and in winter period)

$T_o$  : Outdoor temperature (It varies from month to month)

$$U_i \cdot A_i = 105,62$$

$$U_o \cdot A_o = 188,42 + 4,23 + 12,8 + 19,04 + 2,67 = 227,16 \text{ W/C}$$

$$\text{January: } T_i = 21^\circ\text{C} \quad T_o = 5,7^\circ\text{C} \quad T_s = \frac{(105,62 \cdot 21) + (227,16 \cdot 5,7)}{105,62 + 227,16} = 10,6^\circ\text{C}$$

$$\text{February: } T_i = 21^\circ\text{C} \quad T_o = 5,9^\circ\text{C} \quad T_s = 10,7^\circ\text{C}$$

$$\text{March: } T_i = 21^\circ\text{C} \quad T_o = 7,3^\circ\text{C} \quad T_s = 11,7^\circ\text{C}$$

$$\text{April: } T_i = 21^\circ\text{C} \quad T_o = 10,9^\circ\text{C} \quad T_s = 14,1^\circ\text{C}$$

May:	$T_i = 25,5\text{ }^\circ\text{C}$	$T_o = 25,9\text{ }^\circ\text{C}$	$T_s = 25,8\text{ }^\circ\text{C}$
June:	$T_i = 25,5\text{ }^\circ\text{C}$	$T_o = 30,6\text{ }^\circ\text{C}$	$T_s = 29\text{ }^\circ\text{C}$
July:	$T_i = 25,5\text{ }^\circ\text{C}$	$T_o = 33\text{ }^\circ\text{C}$	$T_s = 30,6\text{ }^\circ\text{C}$
August:	$T_i = 25,5\text{ }^\circ\text{C}$	$T_o = 32,7\text{ }^\circ\text{C}$	$T_s = 30,4\text{ }^\circ\text{C}$
September:	$T_i = 25,5\text{ }^\circ\text{C}$	$T_o = 29\text{ }^\circ\text{C}$	$T_s = 27,9\text{ }^\circ\text{C}$
October:	$T_i = 21\text{ }^\circ\text{C}$	$T_o = 14,4\text{ }^\circ\text{C}$	$T_s = 16,5\text{ }^\circ\text{C}$
November:	$T_i = 21\text{ }^\circ\text{C}$	$T_o = 10,6\text{ }^\circ\text{C}$	$T_s = 13,9\text{ }^\circ\text{C}$
December:	$T_i = 21\text{ }^\circ\text{C}$	$T_o = 7,5\text{ }^\circ\text{C}$	$T_s = 11,8\text{ }^\circ\text{C}$

Table 6.15. Monthly average sunspace temperature

	Jan.	Feb.	Mar.	Apr.	May	Jun.	Jul.	Aug.	Sep.	Oct.	Nov.	Dec.
$T_s$	10,6	10,7	11,7	14,1	25,8	29	30,6	30,4	27,9	16,5	13,9	11,8

Table 6.16. Monthly sunspace heat transmission loss for two directions

MONTHLY HEAT TRANSMISSION LOSS OF ZONE-2						
Month	U x A W/C	Ts	Tout	$\Delta T (T_s - T_{out})$	Heat Lost	
		C	C	C	W	MJ/day
January	227,48	10,6	5,7	4,9	1114,65	96,31
February		10,7	5,9	4,8	1091,90	94,34
March		11,7	7,3	4,4	1000,91	86,48
April		14,1	10,9	3,2	727,94	62,89
May						0,00
June						0,00
July		SUMMER PERIOD				0,00
August						0,00
September						0,00
October		16,5	14,4	2,1	477,71	41,27
November		13,9	10,4	3,5	796,18	68,79
December		11,8	7,5	4,3	978,16	84,51
TOTAL :						<b>6187,46</b>

Table 6.17. Monthly sunspace heat transmission gain for two directions

MONTHLY HEAT TRANSMISSION GAIN OF ZONE-2							
Month	U x A	Tout	Ts	ΔT (Tout-Ts)	Heat Gain		
	W/C	C	C	C	W	MJ/day	
January	227,48						
February							
March		WINTER PERIOD					
April							
May		25,9	25,8	0,1	22,75	1,97	
June		30,6	29	1,6	363,97	31,45	
July		33	30,6	2,4	545,95	47,17	
August		32,7	30,4	2,3	523,20	45,20	
September		29	27,9	1,1	250,23	21,62	
October							
November		WINTER PERIOD					
December							
TOTAL :						<b>1706,10</b>	<b>147,41</b>

### 6. 2. 3. 3. Internal Heat Gains

As expressed in the previous chapter,

$$Q_i = Q_p + Q_{light} + Q_e \quad (6. 8)$$

$Q_p$  : Heat gain from people:

$$Q_p = S \cdot SHG \cdot CLF + S \cdot LHG \quad (6. 9)$$

$SHG$  : Sensible heat gain

$LHG$  : Latent heat gain

$S$  : Number of people. The Cafe is assumed to be 33 % full so;

$$S = 15$$

The space temperature does not change so;

$$CLF = 1$$

$$Q_p = 15 \cdot 75 \cdot 1 + 15 \cdot 95 = 2550 \text{ W}$$

$Q_{light}$  : **Heat gain from lightening:**

$$Q = LightingLoad \cdot A \cdot CLF \quad (6. 10)$$

$$LightingLoad = 5 \text{ W/m}^2$$

Lighting period is six hours a day so,

$$CLF = 0,25$$

$$A = 100 \text{ m}^2$$

$$Q = 5 \cdot 100 \cdot 0,25 = 125 \text{ W}$$

$Q_e$  : **Heat gain from equipment:**

$$Q_e = P \cdot CLF \quad (6. 11)$$

Equipments in the cafe;

$$\text{Toaster: } 1,5 \text{ kW} = 1500\text{W}$$

$$\text{Kettle: } 0,25 \text{ kW} = 250 \text{ W}$$

$$\text{Refrigerator: } 1,5 \text{ kW} = 1500 \text{ W}$$

$$P = 1500+250+1500 = 3250\text{W}$$

$$CLF = 1$$

$$Q_e = 3250 \cdot 1 = 3250 \text{ W}$$

$Q_i$  : **Internal heat gain:**

$$Q_i = 2550 + 125 + 3250 = 5925 \text{ W} = 21,33 \text{ MJ/day}$$

As it is seen in the table, in summer period, east and west sides of the sunspace receive the most energy. Therefore, these parts have been separated from the rest of the sunspace with doors.

### **6. 2. 3. 2. Infiltration and Ventilation Loss**

In our project, the sensible heat load of infiltration is represented. For zone1, infiltration increases the heat loss in winter while it gives rise to heat gain in summer. For Zone2, in winter there is a heat flow to the outside. Depending on interior temperature, and temperature difference between Zone 1 and Zone 2, heat flow to Zone 1 is managed by opening vents in winter. In summer, the vents are closed to eliminate excessive heat gain.

$$Q_{sb} = V \cdot \rho \cdot c_{pa} \cdot (T_i - T_o) \cdot n \quad (6.12)$$

**Zone 1:**

$$V = 100 \text{ m}^2 \cdot 2,7 \text{ m} = 270 \text{ m}^3$$

$$c_{pa} = 1,007 \text{ kJ / kg } ^\circ\text{C} = 0,279 \text{ W / kg } ^\circ\text{C}$$

$$\rho = 1,194 \text{ kg / m}^3$$

n : Air change factor

$$n = 1 \text{ (from ASHREA)}$$

Calculations have been done for 20 °C and 100 kPa. As temperature swings do not affect the result, they are omitted.

As a result;

$$\text{Ventilation - U. A} = 270 \cdot 1,194 \cdot 0,279 \cdot 1 = 89,94 \text{ W/C}$$

**Zone 2 :**

$$V = 83 \text{ m}^3$$

$$V \cdot \rho \cdot c_{pa} = 83 \cdot 1,194 \cdot 0,279$$

$$= 27,68 \text{ W/C}$$

Infiltration calculations have been done by assuming that the vent between the sunspace and the living space is closed. Therefore, it is assumed that there is not any infiltration through the vent to Zone1.

The calculation of infiltration results are given in Table 6.18 and Table 6.19

Table 6.18a Monthly infiltration loss for the living space for two directions

Month	Heat loss - By Infiltration						
	V. p.c.n.	Tin	Tout	$\Delta T$	Heat Lost		
	W/C	C	C	C	W	MJ/day	
January	89,94	21	5,7	15,3	1376,08	118,89	
February		21	5,9	15,1	1358,09	117,34	
March		21	7,3	13,7	1232,18	106,46	
April		21	10,9	10,1	908,39	78,49	
May						0,00	
June						0,00	
July		SUMMER PERIOD					0,00
August						0,00	
September						0,00	
October		21	14,4	6,6	593,60	51,29	
November		21	10,4	10,6	953,36	82,37	
December		21	7,5	13,5	1214,19	104,91	
TOTAL :					7635,91	659,74	

Table 6.18b Monthly infiltration gain for the living space for two directions

Month	Heat Gain - By Infiltration						
	V. p.c.n.	Tin	Tout	$\Delta T$	Heat Gain		
	W/C	C	C	C	W	MJ/day	
January	89,94				0,00	0,00	
February		WINTER PERIOD				0,00	0,00
March					0,00	0,00	
April					0,00	0,00	
May		25,5	25,9	0,4	35,98	3,11	
June		25,5	30,6	5,1	458,69	39,63	
July		25,5	33	7,5	674,55	58,28	
August		25,5	32,7	7,2	647,57	55,95	
September		25,5	29	3,5	314,79	27,20	
October					0,00	0,00	
November		WINTER PERIOD				0,00	0,00
December					0,00	0,00	
TOTAL :					2131,58	184,17	

Table 6.19a Monthly infiltration loss for the sunspace for two directions

Month	Heat loss - By Infiltration					
	V . p.c.n WC	Ts	Tout	ΔT	Heat Lost	
		C	C	C	W	MJ/day
January	27,68	10,6	5,7	4,9	135,63	11,72
February		10,7	5,9	4,8	132,86	11,48
March		11,7	7,3	4,4	121,79	10,52
April		14,1	10,9	3,2	88,58	7,65
May						0,00
June						0,00
July						0,00
August						0,00
September						0,00
October		16,5	14,4	2,1	58,13	5,02
November		13,9	10,4	3,5	96,88	8,37
December		11,8	7,5	4,3	119,02	10,28
TOTAL :				752,90	65,05	

Table 6.19b Monthly infiltration gain for the sunspace for two directions

Month	Heat Gain - By Infiltration					
	V . p.c.n WC	Ts	Tout	ΔT	Heat Gain	
		C	C	C	W	MJ/day
January	27,68					0,00
February						0,00
March						0,00
April						0,00
May		25,8	25,9	0,1	2,768	0,24
June		29	30,6	1,6	44,288	3,83
July		30,6	33	2,4	66,432	5,74
August		30,4	32,7	2,3	63,664	5,50
September		27,9	29	1,1	30,448	2,63
October						0,00
November						0,00
December						0,00
TOTAL :				207,60	17,94	

## **6. 2. 3. 4. Passive Solar Gain**

The following tables show calculation results of;

- Living space total monthly solar heat gain for south-facing, north-facing and rotating position of the cafe,
- Sunspace total monthly solar heat gain for south-facing, north-facing and rotating position of the cafe,
- Net heat gain of the sunspace for south-facing, north-facing and rotating position of the cafe,
- Total heating and cooling load of the living space for south-facing, north-facing and rotating position of the cafe,



Table 6.20. Total monthly solar heat gain of Living space for the south facing

1. Case : Sunspace Facing the South

Zone -1 Total Monthly Solar Energy Heat Gain														
Month	North Facing			South Facing			West Facing			East Facing			Total Solar Heat Gain (Qs)	
	S	A	Total	S	A	Total	S	A	Total	S	A	Total	MJ/day	W/h
	MJ/m <sup>2</sup>	m <sup>2</sup>	MJ	MJ/m <sup>2</sup>	m <sup>2</sup>	MJ	MJ/m <sup>2</sup>	m <sup>2</sup>	MJ	MJ/m <sup>2</sup>	m <sup>2</sup>	MJ		
January	1,54	4,74	7,30	4,41	15,3	67,47	2,7	0,64	1,73	2,7	0,64	1,73	78,23	905,42
February	2	4,74	9,48	4,56	15,3	69,77	3,79	0,64	2,43	3,79	0,64	2,43	84,10	973,37
March	2,6	4,74	12,32	3,89	15,3	59,52	5,04	0,64	3,23	5,04	0,64	3,23	78,29	906,16
April	3,01	4,74	14,27	3,04	15,3	46,51	6,72	0,64	4,30	6,72	0,64	4,30	69,38	803,02
May	3,17	4,74	15,03	2,4	15,3	36,72	8,49	0,64	5,43	8,49	0,64	5,43	62,61	724,69
June	2,93	4,74	13,89	1,74	15,3	26,62	9,01	0,64	5,77	9,01	0,64	5,77	52,04	602,36
July	2,73	4,74	12,94	1,7	15,3	26,01	9,36	0,64	5,98	9,35	0,64	5,98	50,92	589,33
August	2,83	4,74	13,41	2,6	15,3	39,78	9,04	0,64	5,79	9,04	0,64	5,79	64,77	749,60
September	2,64	4,74	13,46	4,54	15,3	69,46	7,58	0,64	4,85	7,58	0,64	4,85	92,63	1072,06
October	2,22	4,74	10,52	5,74	15,3	87,82	5,34	0,64	3,42	5,34	0,64	3,42	105,18	1217,36
November	1,71	4,74	8,11	5,4	15,3	82,62	3,34	0,64	2,14	3,34	0,64	2,14	95,00	1099,54
December	1,47	4,74	6,97	4,7	15,3	71,91	2,54	0,64	1,63	2,54	0,64	1,63	82,13	950,57
<b>TOTAL :</b>			<b>137,70</b>			<b>684,22</b>			<b>46,68</b>			<b>46,68</b>	<b>915,28</b>	<b>10593,47</b>

Table 6.21. Total monthly solar heat gain of Living space for the north facing

2. Case : Sunspace Facing the North

Zone -1 Total Monthly Solar Energy Heat Gain														
Month	North Facing			South Facing			West Facing			East Facing			Total Solar Heat Gain	
	S MJ/m <sup>2</sup>	A m <sup>2</sup>	Total MJ	S MJ/m <sup>2</sup>	A m <sup>2</sup>	Total MJ	S MJ/m <sup>2</sup>	A m <sup>2</sup>	Total MJ	S MJ/m <sup>2</sup>	A m <sup>2</sup>	Total MJ	MJ/day	W/h
January	1,05	15,3	16,07	6,48	4,74	30,72	2,7	0,64	1,73	2,7	0,64	1,73	50,24	581,44
February	1,3	15,3	19,89	7,01	4,74	33,23	3,79	0,64	2,43	3,79	0,64	2,43	57,97	670,93
March	1,56	15,3	23,87	6,48	4,74	30,72	5,04	0,64	3,23	5,04	0,64	3,23	61,03	706,42
April	1,66	15,3	25,40	5,53	4,74	26,21	6,72	0,64	4,30	6,72	0,64	4,30	60,21	696,90
May	1,59	15,3	24,33	4,8	4,74	22,75	8,49	0,64	5,43	8,49	0,64	5,43	57,95	670,67
June	1,29	15,3	19,74	3,95	4,74	18,72	9,01	0,64	5,77	9,01	0,64	5,77	49,99	578,62
July	1,15	15,3	17,60	4,05	4,74	19,20	9,36	0,64	5,98	9,36	0,64	5,98	48,76	564,35
August	1,36	15,3	20,81	5,41	4,74	25,64	9,04	0,64	5,79	9,04	0,64	5,79	58,02	671,56
September	1,65	15,3	25,25	7,83	4,74	37,11	7,58	0,64	4,85	7,58	0,64	4,85	72,06	834,05
October	1,42	15,3	21,73	8,97	4,74	42,52	5,34	0,64	3,42	5,34	0,64	3,42	71,08	822,67
November	1,16	15,3	17,75	7,94	4,74	37,64	3,34	0,64	2,14	3,34	0,64	2,14	59,66	690,50
December	1,03	15,3	15,76	6,72	4,74	31,85	2,54	0,64	1,63	2,54	0,64	1,63	50,86	588,69
<b>TOTAL :</b>			<b>248,17</b>			<b>356,31</b>			<b>46,68</b>			<b>46,68</b>	<b>697,84</b>	<b>8076,79</b>

Table 6.22. Total monthly solar heat gain of living space for the rotation

3. Case : Sunspace Facing the North in Summer Period, Facing the South in Winter Period

Month	Zone-1 Total Monthly Solar Energy Heat Gain													
	North Facing			South Facing			West Facing			East Facing			Total Solar Heat Gain	
	S MJ/m2	A m2	Total MJ	S MJ/m2	A m2	Total MJ	S MJ/m2	A m2	Total MJ	S MJ/m2	A m2	Total MJ	MJ/day	W/h
January	1,54	4,74	7,30	4,41	15,3	67,47	2,7	0,64	1,73	2,7	0,64	1,73	78,23	905,42
February	2	4,74	9,48	4,56	15,3	69,77	3,79	0,64	2,43	3,79	0,64	2,43	84,10	973,37
March	2,6	4,74	12,32	3,89	15,3	59,52	5,04	0,64	3,23	5,04	0,64	3,23	78,29	906,16
April	3,01	4,74	14,27	3,04	15,3	46,51	6,72	0,64	4,30	6,72	0,64	4,30	69,38	803,02
May	1,59	15,3	24,33	4,8	4,74	22,75	8,49	0,64	5,43	8,49	0,64	5,43	57,95	670,67
June	1,29	15,3	19,74	3,95	4,74	18,72	9,01	0,64	5,77	9,01	0,64	5,77	49,99	578,62
July	1,15	15,3	17,60	4,05	4,74	19,20	9,35	0,64	5,98	9,35	0,64	5,98	48,76	564,35
August	1,36	15,3	20,81	5,41	4,74	25,64	9,04	0,64	5,79	9,04	0,64	5,79	58,02	671,56
September	1,65	15,3	25,25	7,83	4,74	37,11	7,58	0,64	4,85	7,58	0,64	4,85	72,06	834,05
October	2,22	4,74	10,52	5,74	15,3	87,82	5,34	0,64	3,42	5,34	0,64	3,42	105,18	1217,36
November	1,71	4,74	8,11	5,4	15,3	82,62	3,34	0,64	2,14	3,34	0,64	2,14	95,00	1099,54
December	1,47	4,74	6,97	4,7	15,3	71,91	2,54	0,64	1,63	2,54	0,64	1,63	82,13	950,57
TOTAL :			176,68			609,05			46,68			46,68	879,09	10174,70

Table 6.23 Total monthly solar heat gain of sunspace for the south facing

1. Case : Sunspace Facing the South

Zone -2 Total Monthly Solar Energy Heat Gain														
Month	North Facing			South Facing			West Facing			East Facing			Total Solar Heat Gain	
	S MJ/m2	A m2	Total MJ	S MJ/m2	A m2	Total MJ	S MJ/m2	A m2	Total MJ	S MJ/m2	A m2	Total MJ	MJ/day	W/h
January	1,54	0	0,00	6,48	29,48	191,03	2,7	12,1	32,67	2,7	12,1	32,67	256,37	2967,25
February	2	0	0,00	7,01	29,48	206,65	3,79	12,1	45,86	3,79	12,1	45,86	298,37	3453,39
March	2,6	0	0,00	6,48	29,48	191,03	5,04	12,1	60,98	5,04	12,1	60,98	313,00	3622,67
April	3,01	0	0,00	5,53	29,48	163,02	6,72	12,1	81,31	6,72	12,1	81,31	325,65	3769,08
May	3,17	0	0,00	4,8	29,48	141,50	8,49	12,1	102,73	8,49	12,1	102,73	346,96	4015,76
June	2,93	0	0,00	3,95	29,48	116,45	9,01	12,1	109,02	9,01	12,1	109,02	334,49	3871,39
July	2,73	0	0,00	4,05	29,48	119,39	9,35	12,1	113,14	9,35	12,1	113,14	345,66	4000,74
August	2,83	0	0,00	5,41	29,48	159,49	9,04	12,1	109,38	9,04	12,1	109,38	378,25	4377,95
September	2,84	0	0,00	7,83	29,48	230,83	7,58	12,1	91,72	7,58	12,1	91,72	414,26	4794,73
October	2,22	0	0,00	8,97	29,48	264,44	5,34	12,1	64,61	5,34	12,1	64,61	393,66	4566,29
November	1,71	0	0,00	7,94	29,48	234,07	3,34	12,1	40,41	3,34	12,1	40,41	314,90	3644,67
December	1,47	0	0,00	6,72	29,48	198,11	2,54	12,1	30,73	2,54	12,1	30,73	259,57	3004,32
<b>TOTAL:</b>			<b>0,00</b>			<b>2216,01</b>			<b>882,57</b>			<b>882,57</b>	<b>3981,16</b>	<b>46078,24</b>

Table 6.24 Total monthly solar heat gain of sunspace for the north facing

2. Case : Sunspace Facing the North

Zone - 2 Total Monthly Solar Energy Heat Gain														
Month	North Facing			South Facing			West Facing			East Facing			Total Solar Heat Gain	
	S MJ/m <sup>2</sup>	A m <sup>2</sup>	Total MJ	S MJ/m <sup>2</sup>	A m <sup>2</sup>	Total MJ	S MJ/m <sup>2</sup>	A m <sup>2</sup>	Total MJ	S MJ/m <sup>2</sup>	A m <sup>2</sup>	Total MJ	MJ/day	W/h
January	1,54	29,48	45,40	6,48	0	0,00	2,7	12,1	32,67	2,7	12,1	32,67	110,74	1281,70
February	2	29,48	58,96	7,01	0	0,00	3,79	12,1	45,86	3,79	12,1	45,86	150,68	1743,96
March	2,6	29,48	76,65	6,48	0	0,00	5,04	12,1	60,98	5,04	12,1	60,98	198,62	2298,80
April	3,01	29,48	88,73	5,53	0	0,00	6,72	12,1	81,31	6,72	12,1	81,31	251,36	2909,25
May	3,17	29,48	93,45	4,8	0	0,00	8,49	12,1	102,73	8,49	12,1	102,73	298,91	3459,60
June	2,93	29,48	86,38	3,95	0	0,00	9,01	12,1	109,02	9,01	12,1	109,02	304,42	3523,36
July	2,73	29,48	80,48	4,05	0	0,00	9,35	12,1	113,14	9,35	12,1	113,14	306,75	3550,35
August	2,83	29,48	83,43	5,41	0	0,00	9,04	12,1	109,38	9,04	12,1	109,38	302,20	3497,64
September	2,84	29,48	83,72	7,83	0	0,00	7,58	12,1	91,72	7,58	12,1	91,72	267,16	3092,12
October	2,22	29,48	65,45	8,97	0	0,00	5,34	12,1	64,61	5,34	12,1	64,61	194,67	2253,17
November	1,71	29,48	50,41	7,94	0	0,00	3,34	12,1	40,41	3,34	12,1	40,41	131,24	1518,97
December	1,47	29,48	43,34	6,72	0	0,00	2,54	12,1	30,73	2,54	12,1	30,73	104,80	1213,00
<b>TOTAL :</b>			<b>856,39</b>			<b>0,00</b>			<b>882,57</b>			<b>882,57</b>	<b>2621,54</b>	<b>30341,92</b>

Table 6.25 Total monthly solar heat gain of sunspace for the rotation

3. Case : Sunspace Facing the North in Summer Period, Facing the South in Winter Period

Month	Zone-2 Total Monthly Solar Energy Heat Gain													
	North Facing			South Facing			West Facing			East Facing			Total Solar Heat Gain	
	S MJ/m <sup>2</sup>	A m <sup>2</sup>	Total MJ	S MJ/m <sup>2</sup>	A m <sup>2</sup>	Total MJ	S MJ/m <sup>2</sup>	A m <sup>2</sup>	Total MJ	S MJ/m <sup>2</sup>	A m <sup>2</sup>	Total MJ	MJ/day	Wh
January	1,54	0	0,00	6,48	29,48	191,03	2,7	12,1	32,67	2,7	12,1	32,67	256,37	2967,25
February	2	0	0,00	7,01	29,48	206,65	3,79	12,1	45,86	3,79	12,1	45,86	298,37	3453,39
March	2,6	0	0,00	6,48	29,48	191,03	5,04	12,1	60,98	5,04	12,1	60,98	313,00	3622,67
April	3,01	0	0,00	5,53	29,48	163,02	6,72	12,1	81,31	6,72	12,1	81,31	325,65	3769,08
May	3,17	29,48	93,45	4,8	0	0,00	8,49	12,1	102,73	8,49	12,1	102,73	298,91	3459,60
June	2,93	29,48	86,38	3,95	0	0,00	9,01	12,1	109,02	9,01	12,1	109,02	304,42	3523,36
July	2,73	29,48	80,48	4,05	0	0,00	9,35	12,1	113,14	9,35	12,1	113,14	306,75	3550,35
August	2,83	29,48	83,43	5,41	0	0,00	9,04	12,1	109,38	9,04	12,1	109,38	302,20	3497,64
September	2,84	29,48	83,72	7,83	0	0,00	7,58	12,1	91,72	7,58	12,1	91,72	267,16	3092,12
October	2,22	0	0,00	8,97	29,48	264,44	5,34	12,1	64,61	5,34	12,1	64,61	393,66	4556,29
November	1,71	0	0,00	7,94	29,48	234,07	3,34	12,1	40,41	3,34	12,1	40,41	314,90	3644,67
December	1,47	0	0,00	6,72	29,48	198,11	2,54	12,1	30,73	2,54	12,1	30,73	259,57	3004,32
TOTAL :			427,46			1448,35			882,57			882,57	3640,96	42140,75

Table 6.26. Net Heat Gain of Sunspace for the South Facing

1. Case : Sunspace Facing the South

NET HEAT GAIN OF ZONE-2					
Month	Qs	Qc	Qv	Net Q	
	MJ	MJ	MJ	MJ/day	Wh
January	256,37	-96,31	-11,72	148,35	1716,97
February	298,37	-94,34	-11,48	192,55	2228,62
March	313,00	-86,48	-10,52	216,00	2499,96
April	325,65	-62,89	-7,65	255,10	2952,57
May	346,96	1,97	0,24	349,17	4041,28
June	334,49	31,45	3,83	369,76	4279,64
July	346,66	47,17	5,74	398,57	4613,12
August	378,25	45,20	5,50	428,96	4964,82
September	414,26	21,62	2,63	438,51	5075,40
October	393,66	-41,27	-5,02	347,37	4020,46
November	314,90	-68,79	-8,37	237,74	2751,61
December	259,57	-84,51	-10,28	164,78	1907,14
TOTAL :				3546,86	41051,58

Note : ( - ) Represents Heat Loss

Table 6.27. Net Heat Gain of Sunspace for the North Facing

2. Case : Sunspace Facing the North

NET HEAT GAIN OF ZONE-2					
Month	Qs	Qc	Qv	Net Q	
	MJ	MJ	MJ	MJ/day	Wh
January	110,74	-96,31	-11,72	2,71	31,42
February	150,68	-94,34	-11,48	44,86	519,19
March	198,62	-86,48	-10,52	101,61	1176,09
April	251,36	-62,89	-7,65	180,81	2092,73
May	298,91	1,97	0,24	301,11	3485,12
June	304,42	31,45	3,83	339,69	3931,62
July	306,75	47,17	5,74	359,66	4162,74
August	302,20	45,20	5,50	352,90	4084,51
September	267,16	21,62	2,63	291,41	3372,80
October	194,67	-41,27	-5,02	240,97	2789,00
November	131,24	-68,79	-8,37	208,40	2412,03
December	104,80	-84,51	-10,28	199,60	2310,19
TOTAL :				2623,75	30367,44

Note : ( - ) Represents Heat Loss

Table 6.28. Net Heat Gain of Sunspace for the Rotation

3. Case : Sunspace Facing the South in Winter and the North in Summer

NET HEAT GAIN OF ZONE-2					
	Qs	Qc	Qv	Net Q	
	MJ	MJ	MJ	MJ/day	Wh
January	256,37	-96,31	-11,72	148,35	1716,97
February	298,37	-94,34	-11,48	192,55	2228,62
March	313,00	-86,48	-10,52	216,00	2499,96
April	325,65	-62,89	-7,65	255,10	2952,57
May	298,91	1,97	0,24	301,11	3485,12
June	304,42	31,45	3,83	339,69	3931,62
July	306,75	47,17	5,74	359,66	4162,74
August	302,20	45,20	5,50	352,90	4084,51
September	267,16	21,62	2,63	291,41	3372,80
October	393,66	-41,27	-5,02	439,96	5092,13
November	314,90	-68,79	-8,37	392,06	4537,73
December	259,57	-84,51	-10,28	354,37	4101,51
TOTAL:				3643,16	42166,26

Note : \*\*\* ( - ) Represents Heat Loss



Table 6.29 : Total Heating and Cooling Load of the Living space for the South Facing

1. Case : Sunspace Facing the South

Month	Zone -1 Total Heating and Cooling Load										Total Load MJ/day
	Q- Zone-2		Qs - Solar gain		Qi- Internal		Qc- Transmission		Qv- Infiltration		
	Total MJ	Total MJ	Total MJ	Total MJ	Total MJ	Total MJ	Total MJ	Total MJ	Total MJ		
January	148,35	78,23	21,33	-210,12	-118,89	-81,11					
February	192,55	84,10	21,33	-207,37	-117,34	-26,73					
March	216,00	78,29	21,33	-188,15	-106,46	21,01					
April	255,10	69,38	21,33	-138,71	-78,49	128,62					
May	349,17	62,61	21,33	9,14	3,11	445,36					
June	369,76	52,04	21,33	116,58	39,63	599,35					
July	398,57	50,92	21,33	171,44	58,28	700,54					
August	428,96	64,77	21,33	164,58	55,95	735,59					
September	438,51	92,63	21,33	80,01	27,20	659,67					
October	347,37	105,18	21,33	-90,64	-51,29	331,95					
November	237,74	95,00	21,33	-145,57	-82,37	126,13					
December	164,78	82,13	21,33	-185,40	-104,91	-22,07					
TOTAL :											

Table 6.30 : Total Heating and Cooling Load of the Living space for the North Facing

2. Case : Sunspace Facing the North

Zone -1 Total Heating and Cooling Load												
Month	Q- Zone-2		Qs- Solar gain		Qi- Internal		Qc- Transmission		Qv- Infiltration		Total Load	
	Total MJ		Total MJ		Total MJ		Total MJ		Total MJ		Total MJ/day	
January	2,71		50,24		21,33		-305,03		-118,89		-349,64	
February	44,86		57,97		21,33		-301,37		-117,34		-294,55	
March	101,61		61,03		21,33		-273,01		-106,46		-195,50	
April	180,81		60,21		21,33		-201,67		-78,49		-17,80	
May	301,11		57,95		21,33		8,23		3,11		391,73	
June	339,69		49,99		21,33		101,98		39,63		552,62	
July	359,66		48,76		21,33		149,54		58,28		637,57	
August	352,90		58,02		21,33		143,59		55,95		631,80	
September	291,41		72,06		21,33		69,97		27,20		481,97	
October	240,97		71,08		21,33		-131,70		-51,29		150,39	
November	208,40		59,66		21,33		-210,36		-82,37		-3,35	
December	199,60		50,86		21,33		-269,35		-104,91		-102,47	
TOTAL :												

Note : ( - ) Represents Heat Loss

Table 6.31 : Total Heating and Cooling Load of the Living space for the Rotation

3. Case : Sunspace Facing the North in Summer Period, Facing the South in Winter Period

Month	Zone -1 Total Heating and Cooling Load											
	Q- Zone-2		Qs- Solar gain		Qi- Internal		Qc- Transmission		Qv- Infiltration		Total Load	
	Total	MJ	Total	MJ	Total	MJ	Total	MJ	Total	MJ	Total	MJ/day
January	148,35		78,23		21,33		-210,12		-118,89		-81,11	
February	192,55		84,10		21,33		-207,37		-117,34		-26,73	
March	216,00		78,29		21,33		-188,15		-106,46		21,01	
April	255,10		69,38		21,33		-138,71		-78,49		128,62	
May	301,11		57,95		21,33		8,23		3,11		391,73	
June	339,69		49,99		21,33		101,98		39,63		552,62	
July	369,66		48,76		21,33		149,54		58,28		637,57	
August	362,90		58,02		21,33		143,59		55,95		631,80	
September	291,41		72,06		21,33		69,97		27,20		481,97	
October	347,37		105,18		21,33		-90,64		-51,29		331,95	
November	237,74		95,00		21,33		-145,57		-82,37		126,13	
December	164,78		82,13		21,33		-185,40		-104,91		-22,07	
TOTAL:												

Note : ( - ) Represents Heat Loss

Table 6.32. Annual Auxiliary Heating and cooling Energy

Month	Annual Auxiliary Heating and Cooling Energy		
	1.case MJ/month	2.case MJ/month	3.case MJ/month
January	2433,30	10489,13	2433,30
February	801,90	8836,46	801,90
March	0,00	5864,85	0,00
April	0,00	534,11	0,00
May	13360,80	11751,90	11751,90
June	17980,50	16578,60	16578,60
July	21016,20	19127,10	19127,10
August	22067,70	18954,00	18954,00
September	19790,10	14459,10	14459,10
October	0,00	0,00	0,00
November	0,00	100,50	0,00
December	662,10	3074,10	662,10
<b>TOTAL :</b>	<b>98112,60</b>	<b>109769,86</b>	<b>84768,00</b>

Table 6.33. Energy load comparison of cases

Month	Energy Load Comparison of cases		
	3.case - 1.case MJ/month	3.case - 2.case MJ/month	2.case - 1.case MJ/month
January	0,00	8055,83	8055,83
February	0,00	8034,56	8034,56
March	0,00	5864,85	5864,85
April	0,00	534,11	534,11
May	1608,90	0,00	-1608,90
June	1401,90	0,00	-1401,90
July	1889,10	0,00	-1889,10
August	3113,70	0,00	-3113,70
September	5331,00	0,00	-5331,00
October	0,00	0,00	0,00
November	0,00	100,50	100,50
December	0,00	2412,00	2412,00
<b>TOTAL :</b>	<b>13344,60</b>	<b>25001,86</b>	<b>11657,26</b>

# CHAPTER 7

## CONCLUSION

### 7. 1. Performance of the System and Results

Analyses have been done for three cases of the cafe. For each case, solar heat gain and internal heat gain have been considered to find out total heat gain and heat loss. Thus, total heating load and cooling load of the cafe have been obtained and the amount of saved energy has been compared between each case.

In Figure 7.1, annual heat loss values are shown for the cafe when it faces the south and the north. The results are the sum of transmission and infiltration losses. Transmission losses in Table 6.13 and infiltration losses in Table 6.19b have been used to determine total heat loss of the cafe for south-facing position. Similarly, total heat loss of the cafe for the north-facing position have been determined by using transmission losses in Table 6.14 and infiltration losses in Table 6.19b.

For both positions of the cafe, there is heating load in January, February, March and April. The cafe does not need heating in from May till September. Heat load rises gradually, beginning from October. In January, heat loss reaches the highest value in south-facing position which is 329 MJ/day whereas in north-facing position 424 MJ/day is required for heating the cafe. This means that 29 % more heat is lost.

Figure 7. 2, demonstrates annual heat gain values. It is understood from the figure that when the sunspace is located to the south, heat gain rises. The cooling load of the cafe increases gradually from May to July and cooling peak occurs with 229,72 MJ/day in July. Until October, cooling load decreases. On the other hand, there is no cooling demand in January, February, March, April, October, November and December. Cooling load in south-facing position is 15% higher than the north-facing position. In summer, excessive heat is gained in the sunspace so the cooling load increases. With the help of operable sunroofs, sunspace temperature can be lowered to reach the desired temperature. By doing this, overheating can be eliminated.

Figure 7. 3 shows total monthly solar heat gain of the sunspace. When the rotation is taken into consideration, it is seen in the figure that, the sunspace obtains too much solar heat when it faces the south and the least solar heat is gained when it faces

the north. Therefore, rotating the building to the north is advantageous for decreasing undesired solar heat gain in summer. Similarly, rotating the building to the south is necessary for increasing solar heat gain in winter.

In Figure 7. 3 different solar heat gain values are estimated when the sunspace faces the south and north throughout the year, meaning that sunspace solar heat gain changes depending on the direction.

- In south-facing position a gradual rise has been observed from January to May. Increase in solar heat gains has been expected to continue but in June a slight decrease has been calculated. The reason for obtaining lower value in June is that sunspace has a vertical glazing. This result has been seen in other studies about İzmir as well. Until September solar heat gain goes on rising and maximum heat gain is in September with 414,26 MJ/day.
- When north-facing position is taken into consideration, there is a gradual increase until September. Solar heat gain follows a lowering curve until December. The curve for north-facing position is different from that of south-facing position because the sunspace does not get direct beam in north-facing position. Maximum solar heat gain is obtained in July with 306,75 MJ/day.
- In rotating position, there are two important points where solar heat gain shows a significant fall between April and May and a peak between September and October. The reason of these alterations is that the position of the cafe is changed in these months. Especially in October the increase reaches the highest value. This means that in this month the cafe begins to have a heating demand but by rotating the building solar heat gain is increased. This situation saves heating energy of the cafe.

Figure 7. 4. shows total heating and cooling load of the living space for each case.

- When the sunspace always faces the south, auxiliary heating is required in December, January and February but total cooling load is very high in summer months. In March, April and October, there is not any heating and cooling energy demand.
- When the sunspace always faces the north, auxiliary heating is required from November to April whereas in summer total cooling load is rather lower than the south-facing position.

- In rotating position, the building makes use of advantages of the south-facing and north-facing positions. Heating load curve is the same as south-facing position while cooling load curve is the same as north-facing position.

In Figure 7. 5, total auxiliary heating and cooling energy required for each case are shown.

- For south-facing position, total energy demand is 98112,6 MJ. 4% of the energy is needed for heating and 96% of it is needed for cooling.
- For north-facing position, total energy demand is 109769,86 MJ. 26% of the energy is to be used for heating and 74% is used to be for cooling. Compared to the previous position, there is 11657,26 MJ (12%) rise in total heating and cooling demand.
- For rotating position, total required energy is 84768 MJ. This value shows that some amount of energy has been saved because rotating building benefits the best features of each position.

To sum up, if energy demand in rotating position and north-facing position is compared, 25001,86 MJ equalling 6945 kWh energy difference is found so 23% energy is saved in rotating position. The comparison of rotating position and south-facing position shows that 13344,60 MJ equalling 3707 kWh more energy is required for cooling when the cafe faces the north. Therefore, the amount of saved energy in rotating period is 14%.

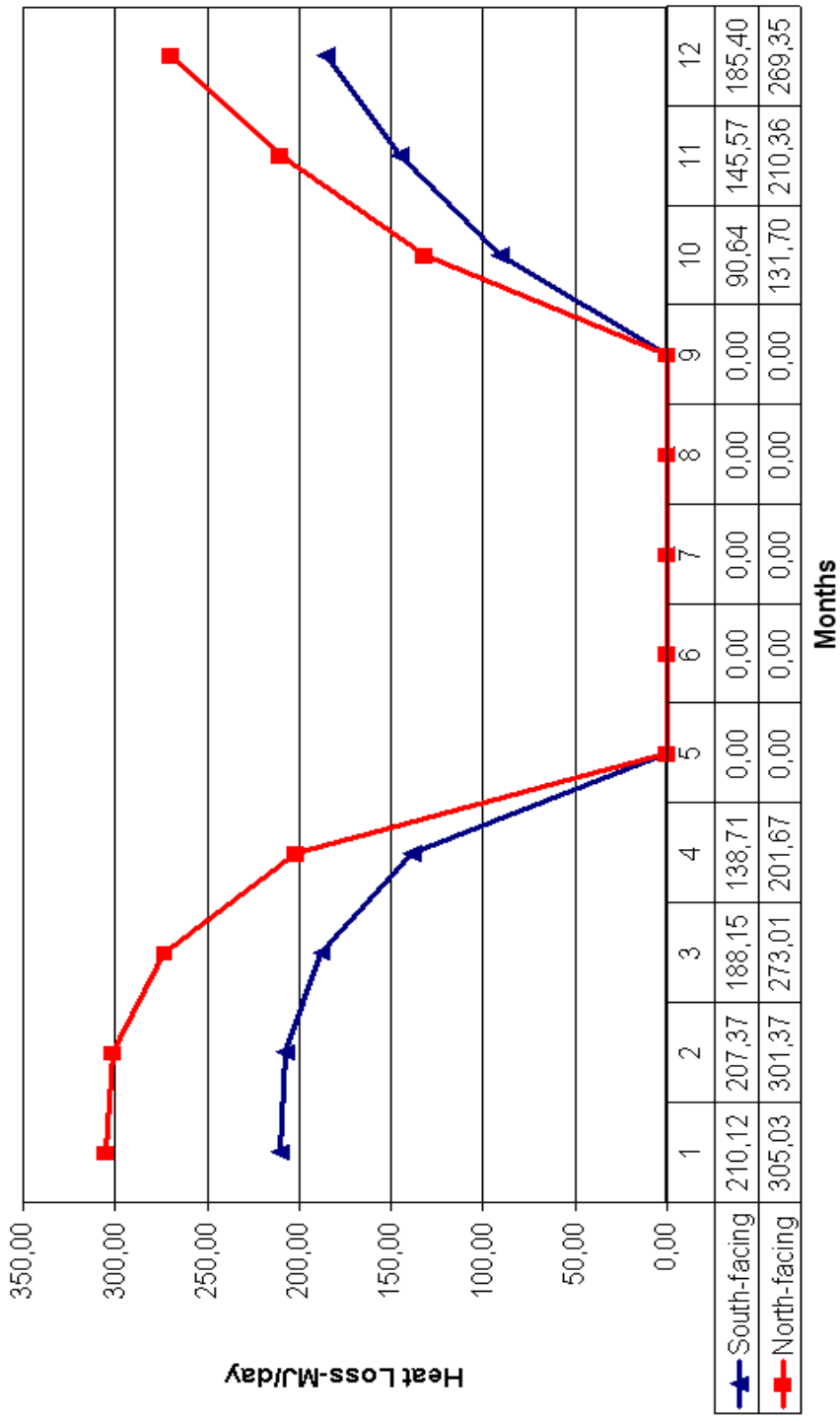
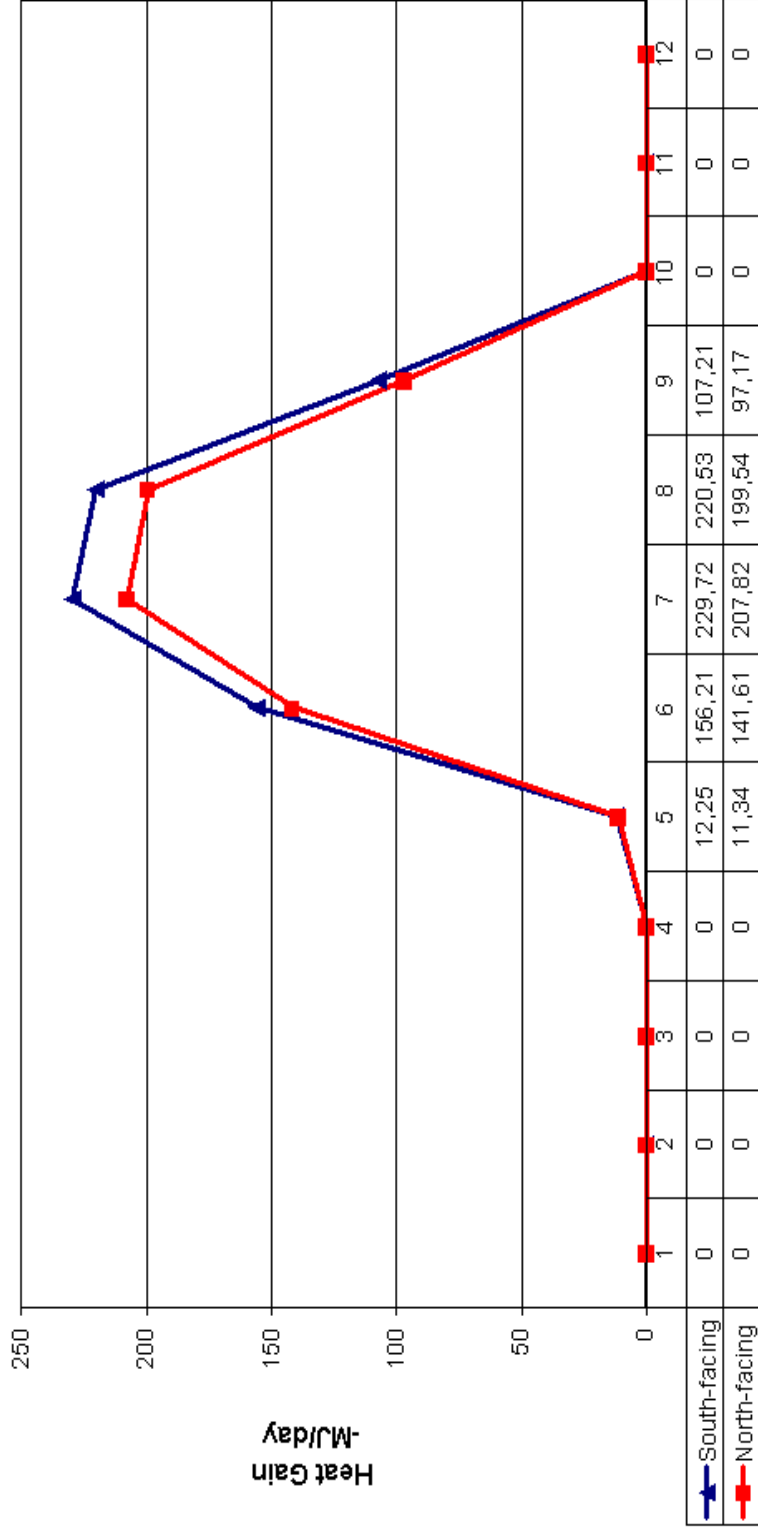

Figure 7.1. Living Space Monthly Heat Loss for Winter Period





Months

Figure 7. 2. Living Space Monthly Heat Gain for Summer Period

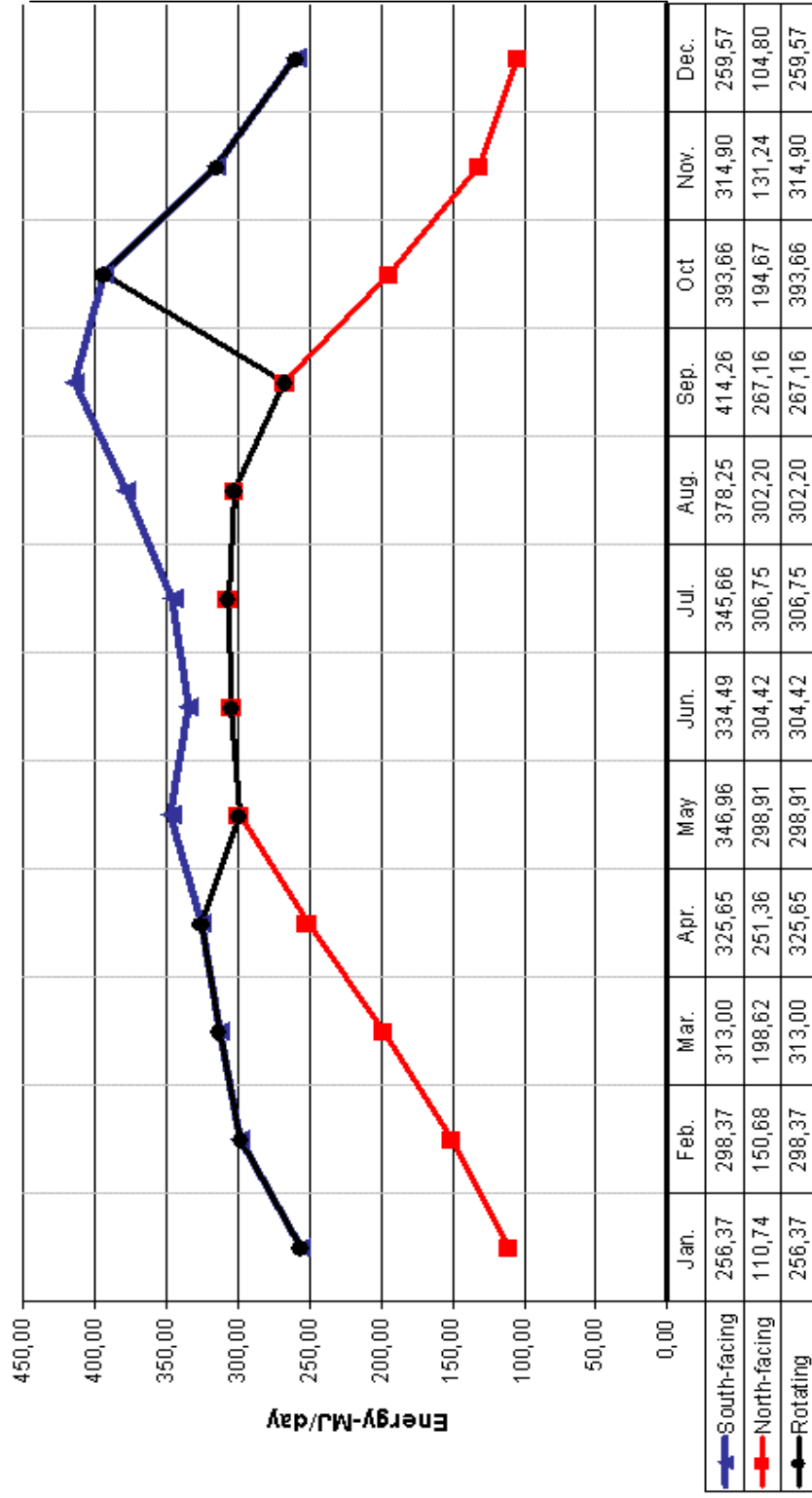

Months

Figure 7. 3. Sunspace Monthly Solar Heat Gain

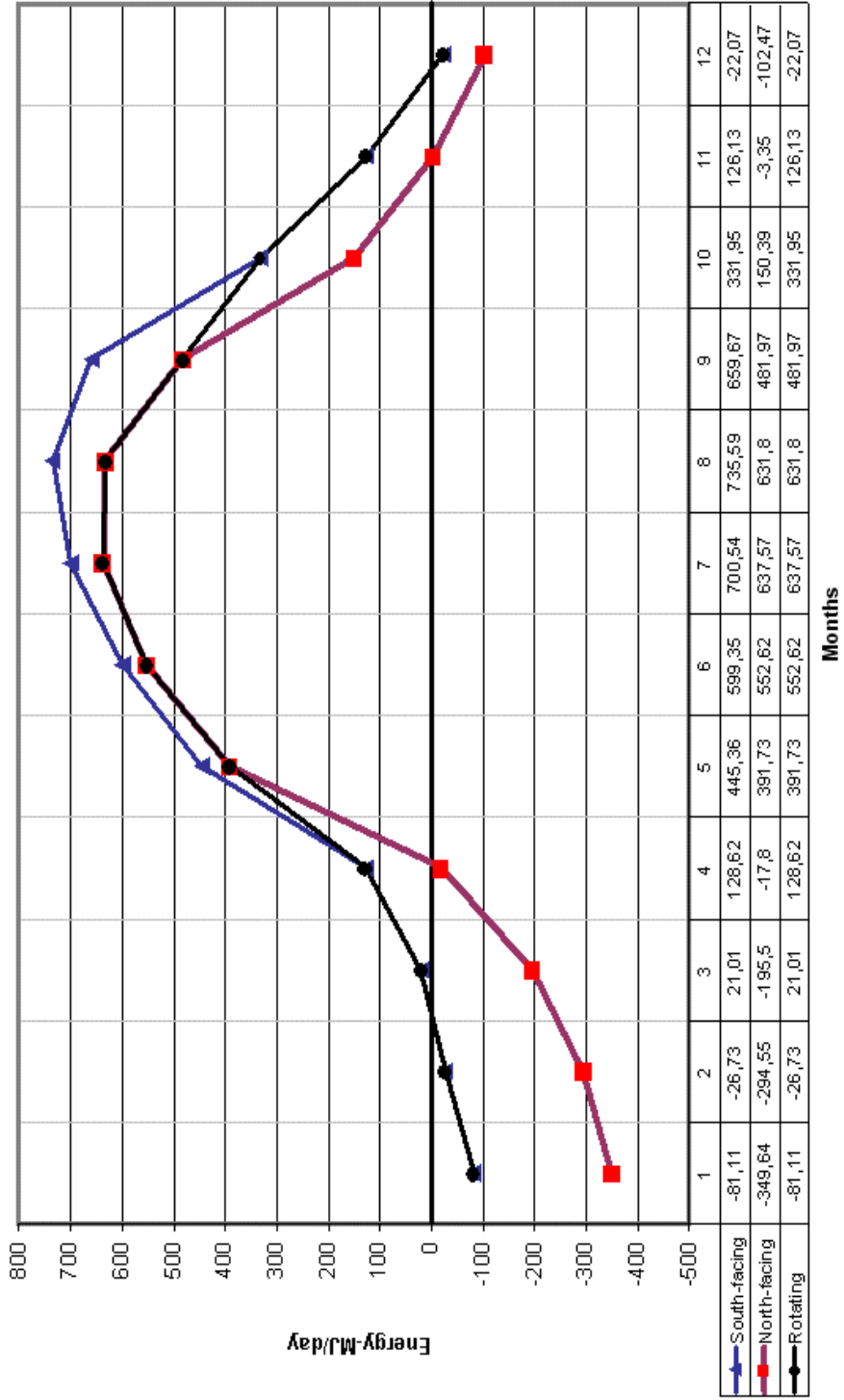

Figure 7. 4. Monthly Heating and Cooling Load Changes

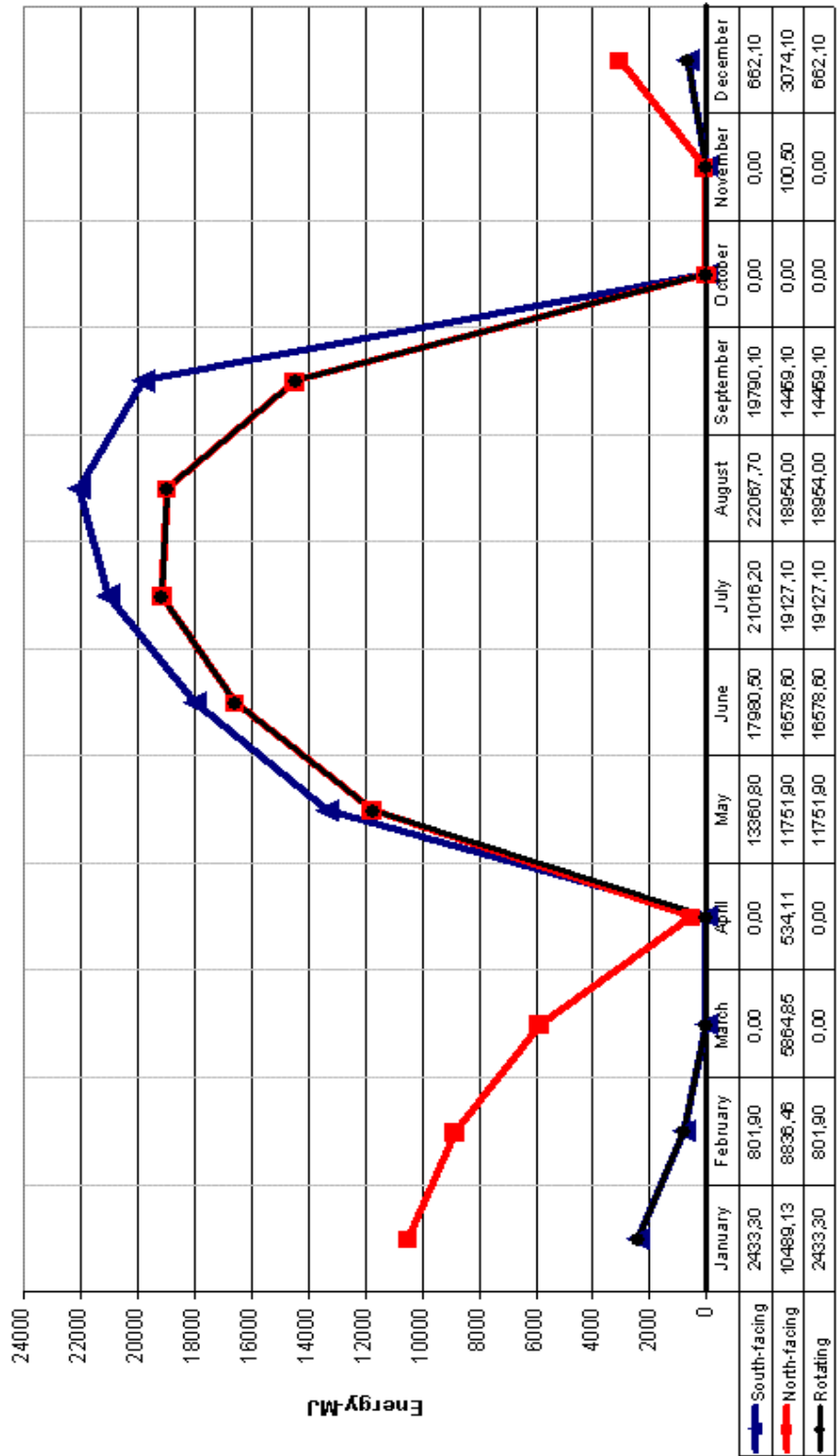

Figure 7. 5. Monthly Auxiliary Heating and Cooling Energy Demand

## 7. 2. Conclusion and Recommendations

In this study, a passive solar building that will function as a cafe at İzmir Institute of Technology Campus has been designed. The reason for planning the cafe by using passive solar design principles is making the cafe energy efficient. For doing this, almost all materials and design of the building are based on their thermal properties and passive solar design principles. The motivation of the thesis is to investigate the effectiveness and efficiency of a rotating solar building.

While determining rotation periods, heating demand has been the primary concern. Heat load of the building depending on heat transmission and infiltration values have been found out and they have been compared with the meteorological data for outdoor temperature taken from Meteorology Department in İzmir (Table A.3). Indoor temperature has been decided from ASHREA standards. As a result, rotation periods have been formed on the basis of heat loss values which have been estimated from indoor and outdoor temperature differences. Therefore, rotation consists of two periods: winter period, 1<sup>st</sup> October- 30<sup>th</sup> April, and summer period, 1<sup>st</sup> May – 30<sup>th</sup> September. Calculations have been done depending on these rotation periods.

A sunspace and additional passive solar design tools have been designed to increase passive solar gain in winter. The sunspace has been rotated to the north to decrease heat gain in summer as it is determined before. Calculations have shown that, compared to a conventional south-facing passive solar building, 14% less net heat gain has been obtained after rotating the building to the north in summer.

In order to make the building more energy efficient portion of east and west walls of the building have been included into the sunspace. Solar gains obtained from east and west sides of the sunspace provide 40% of heating energy of the cafe. However, they also increase the cooling demand by 60% in summer. Therefore, west and east parts of the sunspace can be separated from the rest of the space by operable doors to reduce the cooling load. Besides, efficient use of shading devices and sunroofs can result in a decrease in cooling load as well.

While determining the rotation periods of the cafe, in terms of solar heat gain in winter, the efficiency of rotating the building throughout the day has been questioned. However, the required energy for rotating the building all day could overcome the amount of saved energy for heating and cooling the building so this option has been

omitted. Rather than tracking the sun, a sunspace which covers a part of west and east-facing walls has been designed to increase solar heat gain in winter. It worked well and 33% more heat gain obtained from the sunspace in a year. The efficiency of a building which rotates throughout the day can be investigated in future studies and static analyses can be done to see the appropriateness of such a building as well.

After the living space energy demand calculations, it has been seen that rotating periods can be changed. Calculations have shown that although heating demand is 185 MJ/day in October, 331,95 MJ/day heat gain is obtained in south-facing position whereas 150,39 MJ/day is the heat gain of north-facing position. For that reason, according to weather conditions of the year, summer period can be re-arranged to include October.

Energy demand for rotation is quite low as it uses 2 x 1,5 kW electric energy. If rotation lasts thirty minutes, it consumes 1,5 kW electric energy. The cost of constructing the rotation system is important. In future studies, cost analysis can be carried out to find out the period of time in which the saved energy pays off the cost of rotation system. Another subject for future studies can be on energy savings of rotating buildings that have different sizes and the efficiency and cost analysis of their rotating system. In colder climate conditions, this case might have performed better than İzmir so thermal performance of rotating solar buildings in different climate conditions can be studied in future studies.

It is difficult to integrate both summer and winter conditions in a conventional passive solar house because some deficiencies occur due to seasonal conditions. In this project, it has been seen that rotation system makes the architectural design of a passive solar building easier for architects. Furthermore, rotation system makes the owner to have an option in using the building for different weather conditions.

Consequently, it is found out that, in terms of seasonal heating and cooling requirements of a building, rotation system is beneficial for utilizing advantages of both south-facing and north-facing buildings by changing the building direction. In this project, it is proven that rotation system is effective in saving heating and cooling energy.

## REFERENCES

- Anderson, Bruce, 1990. *Solar Building Architecture: Solar Heat Technologies*, The MIT Press, Cambridge, Massachusetts, London, England.
- Andrejko, Dennis A. And Wright, David, 1982. *Passive Solar Architecture: Logic and Beauty – 35 Outstanding Houses Across the United States*, Van Nostrand Reinhold Company, N.Y
- ASHRAE Handbook-Fundamentals, 2001: *Residential Cooling and Heating Load Calculations*, ASHRAE Handbook-Fundamentals, 2001.
- Atagündüz, Gürbüz, 1989. Güneş Enerjisi Temelleri ve Uygulamaları, Ege Üniversitesi Basımevi, İzmir.
- Carroll, Joseph A., 1982. “A Simple Method for Estimating Heating and Cooling Performance of Buildings Having Multiple Passive or Hybrid Features” in *Passive Solar Energy Systems*, USA.
- Carter, Cyril, deVillers, Jaha, 1987. *Passive Solar Building Design*, Pergamon Press, New York, Oxford.
- Çengel, Yunus A., 1998. *Heat Transfer: A Practical Approach*, McGraw-Hill, Boston.
- Duffie, John A., Beckman, William A., 1991. *Solar Engineering of Thermal Processes*, John Willey & Sons, New York.
- Eğrican, Nilüfer, Onbaşıoğlu, Hüseyin, 1996. “Güneş Evleri”, *Termodinamik*. Vol. 49, p. 90-97.
- Evans, John M. et al.,1991. “Potential of Attached sunspaces in the South of Argentina and Design Guidelines” in *Energy Conservation in Buildings*, Pergamon Press, Oxford.
- Filippin C. , Beascochea A., Esteves A., De rosa C., Cortegoso L. and Estelrich D., 1998: *A passive solar building for ecological research in Argentina: the first two years experience*. Solar Energy Vol. 63, No. 2.
- Güneş, Mustafa, 1999. “Calculation of Solar Radiation on Inclined Surfaces in Turkey” in *1999 Solar World Congress*, Vol. 1, Jerusalem, Israel.
- Hans, D. Lembke H., 1985. *Energy Use in Residential Buildings in Greater Amman*, Vol. 2, Royal Scientific Society.
- Isısan Çalışmaları No. 325: Güneş Enerjisi Tesisatı*,p.122.

- Jolicoeur, C., Paradis, M., Faucher G., 1987. "A Simple Model for the Simulation of Passively Heated Direct Gain House without Backup Heating", in *Alternative Energy Sources*, Vol. 2, edited by Nejat Veziroğlu, Hemisphere Publishing, Washington.
- Kachadorian, James, 1997. *The Passive Solar House*, White River Junction, Chelsea Green Pub. Co.
- Kreider, J. F., Hoogendorn, C. F., Kreith F., 1989. *Solar Design: Components, Systems, Economics*, Hemisphere, New York.
- Lunde, P. J., 1980. *Solar Thermal Engineering Space Heating and Hot Water Systems*, John Willey & Sons, New York.
- Meinel, A. B., Meinel, M. P., 1979. *Applied Solar Energy*, Addison-Wesley Publishing Company, California.
- Moore, Fuller, 1993. *Environmental Control Systems – Heating Cooling Lighting*, McGraw-Hill, London.
- O'Sullivan, Patrick Edmund, 1988. *Passive Solar Energy in Buildings*, Elsevier Applied Science, London.
- Özdamar, A., Özbalta, N., Akin, A., Yıldırım, D., "An Application of a Combined Wind and Solar Energy System in İzmir", *Renewable & Sustainable Energy Reviews*, June, 2004.
- Parker, B. F. (Ed.), 1991. *Solar Energy in Agriculture*, Elsevier, Amsterdam.
- Rapp, D., 1981. *Solar Energy*, Prentice-Hall Inc., New Jersey.
- Sayigh A. A. M., 1979. *Solar Energy Application in Buildings: Passive Cooling of Buildings*, Academic Press, New York, San Francisco, London.
- Sayigh, A. A. M., 1991., *Energy Conservation in Buildings*, Pergamon Press, Oxford.
- Tayton, J. E., Elifrits, C. D., Howell, R. H., 1987. "A Comparison of Heating Energy Consumption of a Family in a Conventional House and an Earth-Bermed Passive Solar House", in *Alternative Energy Sources*, Vol. 2, edited by Nejat Veziroğlu, Hemisphere Publishing, Washington.
- Tombasiz, A. N., Preuss, S. A., 2001. "Design of Passive Solar Buildings in Urban Areas", *Solar Energy*, 70.
- Wachberger, Michael, Wachberger, Hedy, 1988. *Güneş ve Konut*, Yaprak Kitabevi, Ankara.
- WEB\_1, 2005. "Chapter 4. Ventilation and Air Conditioning", 10/04/2005, <http://www.state.hi.us/dbedt/ert/>



- WEB\_2, 2005. "Cooling Load Calculations", 15/03/2005, <http://energy.ca.gov/reports/>
- WEB\_3, 2005. "Design for the Sun", 17/02/2005, <http://www.waitekere.govt.nz/AbtCit/ec/bldsus/pdf/energy/designsun.pdf>
- WEB\_4, 2005. Energy Information Administration Web Page, 10/04/2005, <http://www.eia.doe.gov,2004>
- WEB\_5, 2005. "Glossary", 26/02/2005, <http://www.windowfilm.org/gloss.html>
- WEB\_6, 2005. "The Rotating Home", Gastite Web Site,03/04/2003, <http://www.gastite.com/include/languages/english/download/pdfs>
- WEB\_7, 2005. "Metal Roofing", 11/04/205, <http://www.fpl.com>
- WEB\_8, 2005. "Natural Cooling", 12/03/2005, <http://www.azsolarcenter.com/design/passive-3.html>
- WEB\_9, 2005. "Passive Solar Architecture-Heating", 12/03/2005, <http://www.azsolarcenter.com/design/passive2.html>
- WEB\_10, 2005. "Passive Solar Design", 12/03/2005, <http://www.arch.mcgill.ca/prof/sijpkes/arch304>
- WEB\_11, 2005. "Passive Solar Energy II", 12/03/2005, <http://www.illinoissolar.com>
- WEB\_12, 2005. "Passive Solar Guidelines", 17/02/2005, <http://www.greenbuilder.com/sourcebook/PassSolGuide1-2.html>
- WEB\_13, 2005. "Passive Solar Heating", Fosdick, J., Homes, T. C., 22/02/2005, <http://www.wbdg.org/design/psheating.php>
- WEB\_14, 2005. "A Practical Formula for Air-Cooled Boards in Ventilated Enclosures", 10/04/2005, <http://www.electronics-cooling.com>
- WEB\_15, 2005. "Rotating Apartment", 10/03/2005, <http://www.msnbc.msn.com>
- WEB\_16, 2005. "Rotating Homes", 10/04/2005, <http://www.findaproperty.com>
- WEB\_17, 2005. "A Simple Design Methodology for Passive Solar Architecture", 15/03/2005, <http://www.dennishollowayarchitect.com/html/Solardesign.html>
- WEB\_18, 2005. "Solar Energy Potential for Heating and Cooling Systems", 10/04/2005, <http://www.sciencedirect.com>
- WEB\_19, 2005. "Solar Orientation", 17/02/2005, <http://www.leeric.lsu.edu/bgbb/7/ecep/drafting/d/d.htm>
- WEB\_20, 2005. "Solar Space Heating", 15/03/2005, <http://www.oregon.gov/energy>

WEB\_21, 2005. "Somerset West Revolving House", 10/08/2005,  
[http://www.new24.com/regional\\_Papers/Components/](http://www.new24.com/regional_Papers/Components/)

WEB\_22, 2005. Sunspace Rotating Homes Web page, 03/04/2003,  
<http://www.rotatinghomes.com> and "Architecture Week", 03/04/2003,  
[www.architectureweek.com/2002/1002](http://www.architectureweek.com/2002/1002)

# APPENDIX A

## CALCULATION TABLE

Table A. 1 Overall U-factors for different glazing (Source: ASHREA Handbook of Fundamentals, 2001, Ref. 1, Chap. 27, Table 5)

Type →	Glass section (glazing) only		Aluminum frame (without thermal break)			Wood or vinyl frame						
	Center-of-glass	Edge-of-glass	Fixed	Double door	Sloped skylight	Fixed	Double door	Sloped skylight				
Frame width →	(Not applicable)		32 mm (1¼ in.)	53 mm (2 in.)	19 mm (¾ in.)	41 mm (1⅝ in.)	88 mm (3⅞ in.)	23 mm (⅞ in.)				
Spacer type →	—	Metal Insul.	All	All	All	Metal Insul.	Metal Insul.	Metal Insul.				
<b>Glazing Type</b>												
<b>Single Glazing</b>												
3 mm (⅜ in.) glass	6.30	6.30	—	6.63	7.16	9.88	5.93	—	5.57	—	7.57	—
6.4 mm (¼ in.) acrylic	5.28	5.28	—	5.69	6.27	8.86	5.02	—	4.77	—	6.57	—
3 mm (⅜ in.) acrylic	5.79	5.79	—	6.16	6.71	9.94	5.48	—	5.17	—	7.63	—
<b>Double Glazing (no coating)</b>												
6.4 mm air space	3.24	3.71	3.34	3.90	4.55	6.70	3.26	3.16	3.20	3.09	4.37	4.22
12.7 mm air space	2.78	3.40	2.91	3.51	4.18	6.65	2.88	2.76	2.86	2.74	4.32	4.17
6.4 mm argon space	2.95	3.52	3.07	3.66	4.32	6.47	3.03	2.91	2.98	2.87	4.14	3.97
12.7 mm argon space	2.61	3.28	2.76	3.36	4.04	6.47	2.74	2.61	2.73	2.60	4.14	3.97
<b>Double Glazing [ε = 0.1, coating on one of the surfaces of air space (surface 2 or 3, counting from the outside toward inside)]</b>												
6.4 mm air space	2.44	3.16	2.60	3.21	3.89	6.04	2.59	2.46	2.60	2.47	3.73	3.53
12.7 mm air space	1.82	2.71	2.06	2.67	3.37	6.04	2.06	1.92	2.13	1.99	3.73	3.53
6.4 mm argon space	1.99	2.83	2.21	2.82	3.52	5.62	2.21	2.07	2.26	2.12	3.32	3.09
12.7 mm argon space	1.53	2.49	1.83	2.42	3.14	5.71	1.82	1.67	1.91	1.78	3.41	3.19
<b>Triple Glazing (no coating)</b>												
6.4 mm air space	2.16	2.96	2.35	2.97	3.66	5.81	2.34	2.18	2.36	2.21	3.48	3.24
12.7 mm air space	1.76	2.67	2.02	2.62	3.33	5.67	2.01	1.84	2.07	1.91	3.34	3.09
6.4 mm argon space	1.93	2.79	2.16	2.77	3.47	5.57	2.15	1.99	2.19	2.04	3.25	3.00
12.7 mm argon space	1.65	2.58	1.92	2.52	3.23	5.53	1.91	1.74	1.98	1.82	3.20	2.95
<b>Triple Glazing [ε = 0.1, coating on one of the surfaces of air spaces (surfaces 3 and 5, counting from the outside toward inside)]</b>												
6.4 mm air space	1.53	2.49	1.83	2.42	3.14	5.24	1.81	1.64	1.89	1.73	2.92	2.66
12.7 mm air space	0.97	2.05	1.38	1.92	2.66	5.10	1.33	1.15	1.46	1.30	2.78	2.52
6.4 mm argon space	1.19	2.23	1.56	2.12	2.85	4.90	1.52	1.35	1.64	1.47	2.59	2.33
12.7 mm argon space	0.80	1.92	1.25	1.77	2.51	4.86	1.18	1.01	1.33	1.17	2.55	2.28

Notes:

(1) Multiply by 0.176 to obtain U-factors in  $\text{Btu/h} \cdot \text{ft}^2 \cdot \text{°F}$ .

(2) The U-factors in this table include the effects of surface heat transfer coefficients and are based on winter conditions of  $-18\text{°C}$  outdoor air and  $21\text{°C}$  indoor air temperature, with  $24 \text{ km/h}$  ( $15 \text{ mph}$ ) winds outdoors and zero solar flux. Small changes in indoor and outdoor temperatures will not affect the overall U-factors much. Windows are assumed to be vertical, and the skylights are tilted  $20\text{°}$  from the horizontal with upward heat flow. Insulation spacers are wood, fiberglass, or butyl. Edge-of-glass effects are assumed to extend the 65-mm band around perimeter of each glazing. The product sizes are  $1.2 \text{ m} \times 1.8 \text{ m}$  for fixed windows,  $1.8 \text{ m} \times 2.0 \text{ m}$  for double-door windows, and  $1.2 \text{ m} \times 0.6 \text{ m}$  for the skylights, but the values given can also be used for products of similar sizes. All data are based on 3-mm ( $\frac{3}{16}$ -in.) glass unless noted otherwise.

Table A-2. Heat Transfer Coefficients

Construction Components		Thickness of the elements (m)	Heat Conductivity Value- $\lambda$ (W/mK)	$d/\lambda$ m <sup>2</sup> K/W	Heat Conductivity Coefficient-U W/m <sup>2</sup> K
Wall Surface	Indoor Heat Transfer Coeff.			0,130	
	Interior plaster	0,020	0,870	0,023	
	Aerated Concrete (Ytong)	0,150	0,190	0,789	
	Expanded Polystyrene Board	0,030	0,035	0,857	
	Exterior plaster	0,010	1,400	0,007	
	Outdoor Heat Transfer Coeff.			0,040	
TOTAL				1,847	0,541
Floor	Indoor Heat Transfer Coeff.			0,130	
	Ceramic	0,030	1,300	0,023	
	Slab on grade	0,050	1,400	0,036	
	Expanded Polystyrene Board	0,050	0,035	1,429	
	Damp proof covering	0,003	0,190		
	Reinforced concrete	0,100	2,100	0,048	
	Trapez sac	0,001	40,000	0,000	
	Outdoor Heat Transfer Coeff.			0,130	
TOTAL				1,795	0,557
Ceiling	Indoor Heat Transfer Coeff.			0,130	
	Plaster plate	0,020	0,210	0,095	
	Glass Wool	0,150	0,052	2,885	
	Steel Sheet	0,001	40,000	0,000	
	Reinforced concrete	0,100	2,100	0,048	
	Damp proof cover	0,003	0,190	0,016	
	Slab on grade	0,050	1,400	0,036	
	Outdoor Heat Transfer Coeff.			0,040	
TOTAL				3,249	0,308
Window- Double window -12 mm gap					3,200
Glass Brick					2,800
Summer Roof- Double hung window - Low-e					2,670
Lighting- Double window-low-e, 12 gap					2,670

(cont. on the next page)

Table A-2. Heat Transfer Coefficients (cont.)

Construction elements		Thickness of the elements (m)	Heat Conductivity Value- $\lambda$ (W/mK)	$d/\lambda$ m <sup>2</sup> K/W	Heat Conductivity Coefficient-U W/m <sup>2</sup> K
Sunspace Roof	Indoor Heat Transfer Coeff.			0,130	
	Steel Sheet (Roof panel)	0,002	40,000	0,000	
	Expanded Polystyrene Board	0,050	0,035	1,429	
	Outdoor Heat Transfer Coeff.			0,040	
TOTAL				1,599	0,626
Summer Roof- vert	Indoor Heat Transfer Coeff.			0,130	
	Aluminum	0,002	240,000	0,000	
	Outdoor Heat Transfer Coeff.			0,040	
TOTAL				0,170	5,882

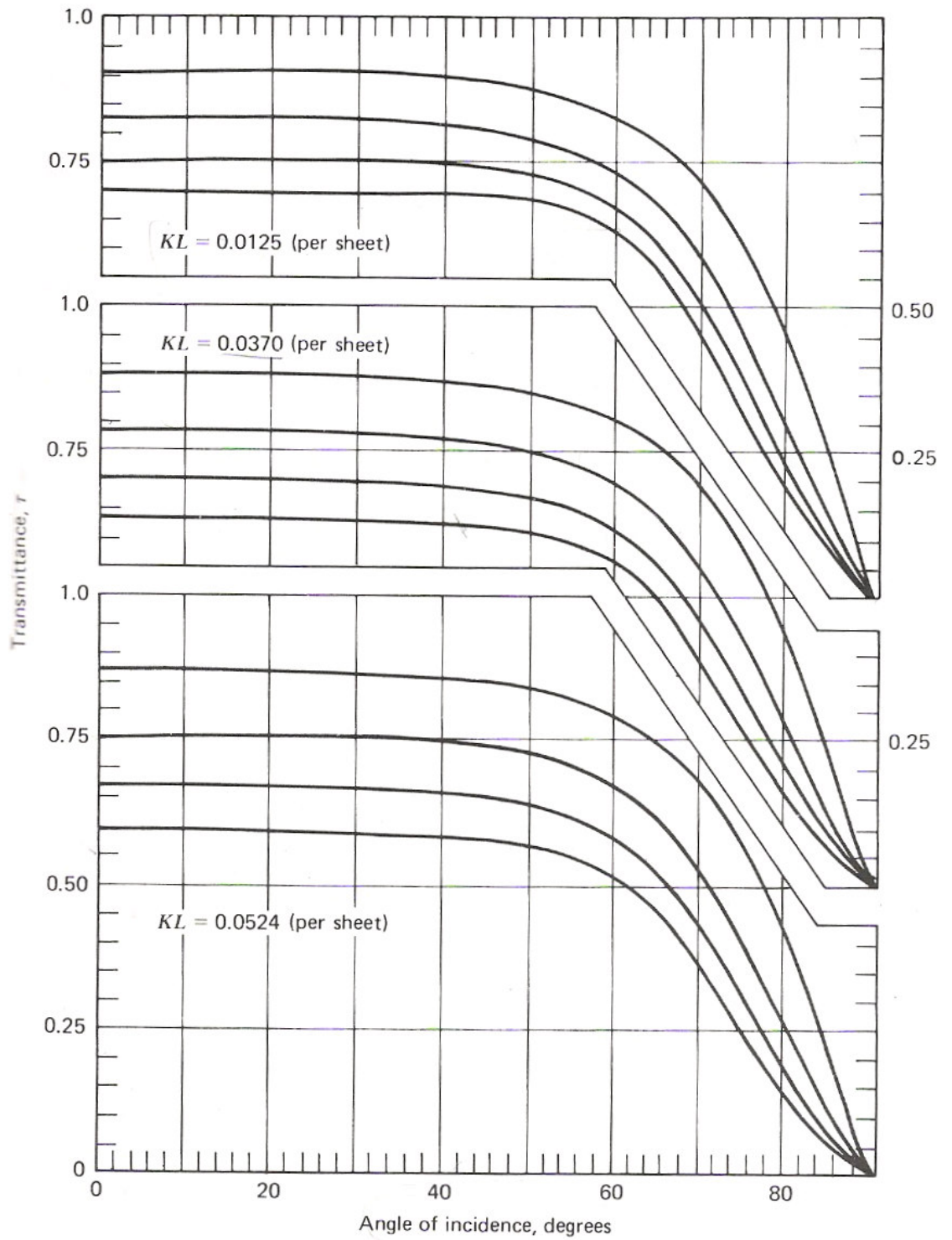

Figure A-1. Transmittance (considering absorption and reflection) of 1, 2, 3 and 4 covers for three types of glass (Adapted from Duffie and Beckman, 1991)

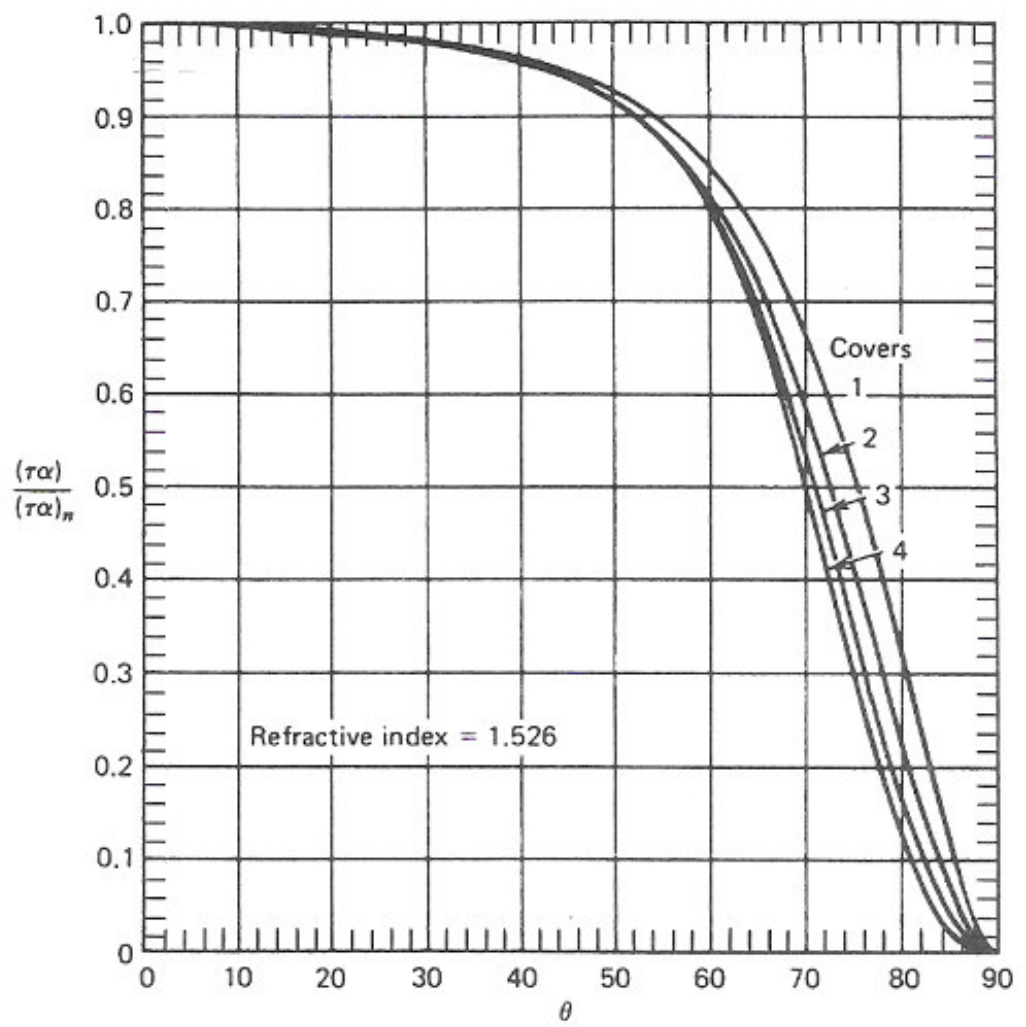

Figure A-2. Typical  $(\tau\alpha)/(\tau\alpha)_n$  curves for 1 to 4 covers.  
 (Adapted from Duffie and Beckman, 1991)



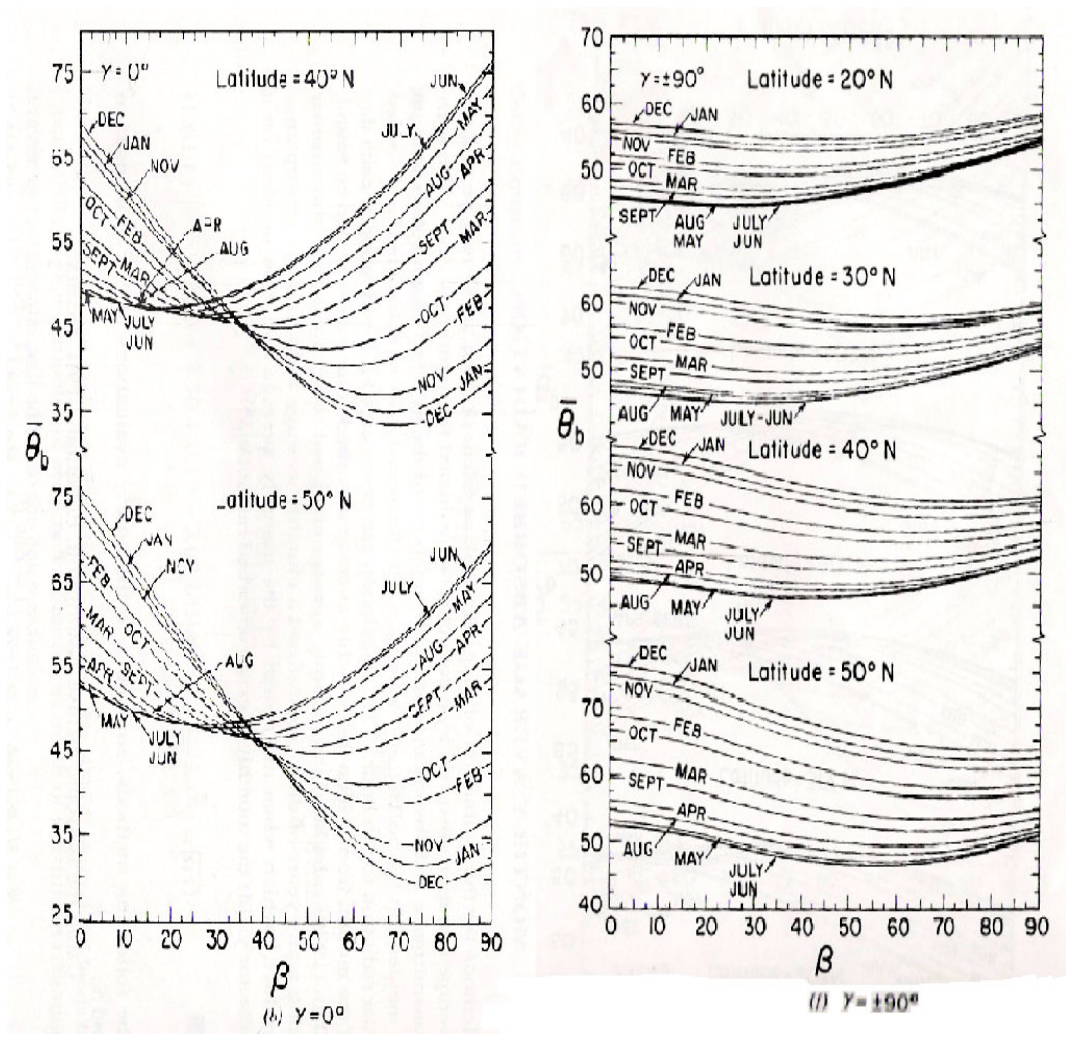

Figure A-3. Monthly average beam incidence angle for various surface locations and orientations (Adapted from Duffie and Beckman, 1991)